

CATALOGUE GÉNÉRAL

CATÁLOGO GENERAL

MAIN CATALOGUE



MOBEL LINEA



MOBEL LINEA, S.L. est une entreprise familiale catalane fondée en 1973, située à Cervera (LIEIDA), petit village de 10.000 habitants.

Sa trajectoire la consolide comme une des entreprises leader de son secteur et une des principales en Europe.

Depuis ses débuts, la croissance a été modérée mais constante, construisant des bases solides pour pouvoir satisfaire au mieux les besoins de nos clients.

Nous sommes actuellement une équipe de 232 personnes avec un chiffre d'affaire réalisé en 2018 de 35.000.000 €, dont 75% correspond à l'exportation.

MOBEL LÍNEA, S.L., empresa familiar catalana, fundada en el año 1973.

Está situada en Cervera, una pequeña ciudad de 10.000 habitantes en la Comarca de La Segarra, provincia de Lleida, establecida en una zona estratégica de comunicaciones por carretera.

En su trayectoria, se ha consolidado como una de las empresas líder en el sector y una de las principales de Europa. Desde sus inicios, el crecimiento ha sido moderado pero constante. Todo este procedimiento nos ha permitido construir unas bases mucho más sólidas para poder atender, con la máxima satisfacción posible, a nuestros clientes.

Actualmente la plantilla está formada por un total de 232 trabajadores.

MOBEL LINEA, S.L. is a family run business founded in 1973.

It is based in Cervera, a small town populated by 10,000 inhabitants, in the province of Lleida (Catalonia), a strategic point with a good traffic infrastructure.

Over time, MOBEL LINEA, SL has become one of the leading manufacturers in the industry, and one of the largest in Europe. From its very foundation, there is a moderate but steady growth, which allows to respond more efficiently to customer demands.

In MOBEL LINEA, S.L. currently work about 232 employees.





CROISSANCE CONSTANTE CRECIENDO DE FORMA CONSTANTE STEADY GROWTH

Ressources
Recursos
Resources



Les installations se sont construites en plusieurs étapes, au fur et à mesure des besoins dus à la croissante demande du marché national et international.

La construction de la nouvelle usine en 1995 située dans la zone industrielle de la même commune vient séparer la production des structures métalliques du reste du mobilier. Notre production est gérée par une unité logistique novatrice depuis la création d'un entrepôt en 2004 entièrement automatisé et auto-portant avec une capacité de 30.000 palettes. D'une hauteur de 41 mètres, lors de sa création, c'était l'entrepôt automatique le plus haut d'Espagne.

En 2011, création d'une annexe de l'autre usine située dans la zone industrielle de Cervera pour la fabrication des armoires métalliques dans laquelle a été installé un nouveau tunnel de peinture beaucoup plus efficace et plus respectueux de l'environnement.

Aujourd'hui, Mobel Línea dispose de 2 usines:

- MOBEL I: avec une surface de 45.000 m², pour la fabrication de meubles et sièges.
- MOBEL III: avec une surface de 13.000 m², pour la fabrication de composants, structures et armoires métalliques.

La industria se ha creado a través de varias fases de ampliación, que han sido necesarias para atender a la creciente demanda del mercado tanto nacional como internacional.

Cabe destacar pues la construcción de una nave nueva en 1995, donde se separó la producción de las estructuras metálicas de los muebles, de la planta principal a otra nave situada en el polígono industrial del mismo municipio. En 2004 se construyó un almacén automático que consiguió una trazabilidad absoluta de todos los productos que fábrica MOBEL LINEA, S.L., éste es autoportante, tiene 41 metros de altura y una capacidad para gestionar 33.000 europalets. Como anécdota, el almacén automático fue el más alto de España en el momento de su construcción.

En 2011 se hizo una ampliación de la nave situada en el polígono industrial, para poder fabricar armarios metálicos, en esta ampliación se substituyó el túnel de pintura, instalando uno nuevo más eficiente y con mayor respeto al Medio Ambiente.

En la actualidad pues, se dispone de dos centros de trabajo:

- MOBEL I: con una superficie de 45.000 m², destinados a la fabricación de muebles y sillas.
- MOBEL III: dispone de 13.000 m² de superficie designada a la fabricación de componentes metálicos, estructuras metálicas para los muebles y armarios metálicos.

Due to the growing market demand, both locally and internationally, MOBEL LINEA has witnessed, gradually and steadily, the increase of its production system.

In 1995 it is built a new factory in the industrial area, with the purpose of separating the production of metal frames to the melamine and wooden panels which are located in the main factory.

In 2004 is remarkable the construction of automated building capable of storing all products produced by Mobel Línea. With 41 meters high and a capacity for 33.000 EUROPALETS it turn out to be the highest in Spain at the time of its construction.

In 2011 the metal factory is expanded with the latest high-technology in order to manufacture metal cabinets. Therefore it is incorporated a new and more efficient painting tunnel which optimizes the energy consumption and respects the environment.

Nowadays there is available 2 manufacturing centers:

- MOBEL I: With a space of 45.000 m², devoted to the production of furniture and chairs.
- MOBEL III: With a space of 13.000 m² devoted to the production of metal components, frame and cabinets.



Qualité
Calidad
Quality

L'engagement envers la qualité et la satisfaction de ses clients est l'un des éléments primordiaux de la politique de **MOBEL LINEA, SL**.

Depuis 2001, un système de gestion en accord avec la norme **ISO 9001:2015** a été mis en place et veille à ce que tous les processus de fabrication garantissent la qualité de nos produits et leurs services.

Le lien qui existe entre la **ISO 9001** et la **ISO 14001** nous permet de mener un système de gestion **INTÉGRÉ**.

Tous les produits bénéficient du tampon qualité contrôlée par le laboratoire de l'Institut technologique du meuble, bois, emballage et autres, **AIDIMA**.

El compromiso con la calidad y la satisfacción de los clientes es uno de los ejes fundamentales que rige la política de **MOBEL LINEA, SL**.

Desde el año 2001 disponemos de un sistema de gestión certificado con la norma **ISO 9001:2015**, que permite garantizar que todos los procesos se orientan al aseguramiento de la calidad de nuestro producto y servicio.

Recordemos la vinculación que existe entre la **ISO 9001** y la **ISO 14001** ya que nos permite llevar a cabo un sistema de gestión **INTEGRADO**.

Todos los productos llevan el sello de calidad controlada del laboratorio del Instituto tecnológico del mueble, madera, embalaje y afines **AIDIMA**.

Quality and customer satisfaction are two of the fundamental approaches at **MOBEL LINEA**.

In 2001 **MOBEL LINEA** has been certified with the quality management standard **ISO 9001:2015** which guarantees that all processes are oriented to the quality assurance of products and service.

The use and the connection of **ISO 9001** with **ISO 14001** have allowed us to conduct an integrated monitoring system.

All products carry the **AIDIMA** quality seal (laboratory of the Technological Institute for furniture, wood, packaging and Similar).

GARANTIE DE QUALITÉ ET SATISFACTION

ASEGURAMOS CALIDAD Y SATISFACCIÓN

QUALITY AND SATISFACTION GUARANTEE



Réseau commercial Red comercial Distributors

Chez **MOBEL LINEA, S.L.**, nous exportons principalement en Europe (**France, Allemagne, Royaume-Uni, Suisse, Belgique, Bulgarie, Portugal, Grèce, etc...**), mais également en dehors de l'Europe (**Émirats Arabes, île de la Réunion, Mayotte, Arabie Saoudite, Qatar, Costa Rica, etc...**). Grâce à notre flotte de **35 camions et 18 remorques**, nous sommes en mesure de réaliser des livraisons à tous nos clients européens, garantissant ainsi les délais de livraisons exigés et permettant même de les écourter en cas d'extrême urgence. En plus de nos camions, nous utilisons le **transport maritime** pour le commerce International par le biais de containers ou groupages, travaillant avec les principales entreprises d'affrètement et obtenant un maximum de garantie de fiabilité, qualité et sécurité de la bonne arrivée de nos produits à destination.

En **MOBEL LINEA, S.L.**, exportamos mayormente en Europa (**Francia, Alemania, Reino Unido, Suiza, Bélgica, Bulgaria, Portugal, Grecia, etc...**), y también fuera de Europa (**Emiratos Arabes, Isla Reunión, Mayotte, Arabia Saudí, Qatar, Costa Rica, etc...**). Gracias a nuestra flota de **35 camiones y 18 remolques**, podemos realizar entregas a todos nuestros clientes europeos, garantizando, en todo momento, el cumplimiento de los plazos de entrega exigidos, con posibilidad de reducirlos en casos de extrema prioridad. Además de nuestros camiones, para el Comercio Internacional, utilizamos el **transporte marítimo**, con contenedores o grupajes, trabajando con las principales compañías navieras del mercado y obteniendo las máximas garantías de fiabilidad, calidad y seguridad en la llegada de nuestros productos a destino.

MOBEL LINEA, S.L. exports mainly in Europe (**France, Germany, United Kingdom, Switzerland, Belgium, Bulgaria, Portugal, Greece, etc ...**) but also outside Europe (**United Arab Emirates, Réunion, Mayotte, Saudi Arabia, Qatar, Costa Rica, etc ...**). **Mobel Linea** has its own modern and well-equipped fleet. It consists of **35 trucks and 18 lorries** for a timely delivery within the EU. For international sea shipment outside Europe, **MOBEL LINEA, SL** collaborate with the world's largest carriers to ensure a timely and safe delivery.

- Zones d'implantations **MOBEL LINEA**.
Zonas donde actualmente está presente **MOBEL LINEA, S.L.**
States with **MOBEL LINEA, S.L. Partners**.
- Zones de croissance prévues par **MOBEL LINEA**.
Zonas en expansión de crecimiento previsto por **MOBEL LINEA, S.L.**
Planned expansion of its global distribution network.



ENGAGEMENT ET SOUTENABILITÉ

COMPROMISO Y SOSTENIBILIDAD

COMPROMISE AND SUSTAINABILITY

Environnement
Medio ambiente
Environmental protection



Chez Mobel Linea, SL, nous nous engageons envers l'environnement et nous développons notre activité respectant les normes et les bonnes conduites environnementales.

Les installations **MOBEL LINEA, SL** et les processus sont dirigés par un système de gestion environnemental certifié en 2005 par la norme **ISO 14001:2015**.

Depuis 2013, intégration de la norme **ISO 14006:2011**, norme internationale qui permet d'intégrer un Système de Gestion Environnemental d'ECODESIGN.

Notre principale matière première est l'agglomérat de particules en bois avec un traitement spécial superficiel de résines mélaminiques. La certification **PEFC** de nos produits atteste de notre engagement avec l'Environnement.

La création et la fabrication des produits tiennent en compte les critères Ecodesign:

- Utilisation des matériaux recyclables.
- Bois provenant d'exploitations durables de ressources forestières - certifiées **PEFC** -.
- Réduction de l'impact environnemental du transport et des déchets grâce à l'optimisation des emballages.
- Nous pouvons garantir un moindre impact environnemental.
- Nous prenons en compte la séparation et une haute recyclabilité des composants en fin de vie utile.



Mobel Linea, SL somos una empresa comprometida con el entorno, desarrollamos nuestra actividad aplicando las normas y buenas prácticas ambientales.

Las instalaciones de **MOBEL LINEA, SL** y nuestros procesos se rigen por un sistema de gestión ambiental certificado en el año 2005 con la norma **ISO 14001:2015**.

Desde el año 2013 se ha implantado la norma **ISO 14006:2011**, esta norma internacional nos permite implantar un Sistema de Gestión Ambiental de Ecodiseño.

Una de nuestras materias primas es el aglomerado de partículas de madera con un tratamiento superficial de resinas melamínicas. La certificación **PEFC** que recibe el producto certifica nuestro compromiso con el Medio Ambiente.

La concepción y desarrollo de los productos se realiza a partir de las premisas del Ecodiseño:

- Uso de materiales reciclables.
- Madera procedente de fuentes sostenibles: certificación **PEFC**.
- Reducción del impacto ambiental del transporte y los residuos generados mediante la optimización de los embalajes.
- Podemos asegurar el menor impacto ambiental durante el uso.
- Tenemos en cuenta la separación y la alta reciclabilidad de los componentes al final de su vida útil.

Mobel Linea, S.L. is committed to protect the environment. The activities are not only based on the general regulations, but also to voluntary standards and experiences.

MOBEL LINEA facilities and our manufacturing process are managed by a regulated environmental system certified in 2005 by the **ISO 14001:2015**.

In 2013 it was implemented the **ISO 14006:2011**. This norm allows us to perform the ecodesign environmental management system.

Chipboard is one of our raw materials with a smooth treatment for the melamine resin substances. **PEFC** certifies our commitment to the environment.

Product concept and development are based on the guidelines of Eco design:

- Recyclable materials usage.
- Wood from sustainable sources: **PEFC** certification.
- Transport and environmental impact reduction as well as the waste generated by the optimization of the packaging.
- Minor environmental impact during its use can be assured.
- We contemplate the separation and high recyclability of the components in the end of its useful life.



INDEX

MOBILIER | MOBILIARIO | FURNITURE



RÉGLABLES
REGULABLES
ADJUSTABLE HEIGHT

010 | IUP



DIRECTION
DIRECCIÓN
EXECUTIVE DESKS

132 | TAK

144 | OPEN



RECEPTION
RECEPCIÓN
RECEPTION

198 | DELTA

210 | ROCK RECEPTION



MOBILIER MODULAIRE
INSTALACIONES
DESK SYSTEMS

024 | STAR

038 | STAR RANGE

056 | TEMPO

068 | ECO

080 | ROCK 4



CLOISONS
MAMPARAS
SCREENS

156 | CALL

166 | ROCK SYSTEMS



ARMOIRES
ALMACENAJE
STORAGE

226 | OH SYSTEMS

244 | METÁLICA



OPÉRATIF
OPERATIVAS
INDIVIDUAL DESKS

092 | SIGMA

106 | TONO

120 | ROCK 3



COLLECTIVITÉS
COLECTIVIDADES
MULTIPURPOSE TABLES

174 | CADI

180 | ESPACE

188 | NET



TABLES DE RÉUNION:
MESAS DE REUNIÓN:
MEETING TABLES:

- UP	- TEMPO
- SIGMA	- ECO
- TONO	- ROCK 4
- STAR	- TAK
- STAR RANGE	- OPEN

262 | CHAISES | SILLERÍA | CHAIRS



FAMILLES SIÈGES
FAMILIAS DE SILLAS
CHAIR FAMILIES

264 | LED

276 | BROS



DIRECTION
DIRECCIÓN
EXECUTIVE

372 | ELBA

378 | VIC

384 | CRETA

392 | EVOLE



COLLECTIVITÉS
AUXILIARES
VISITOR

488 | TOM

500 | MARCO

510 | REPLAY

518 | ONDARA

528 | VIENA

536 | RÓDANO

544 | SPLIT

550 | NAVIA



OPÉRATIF
OPERATIVAS
OFFICE

292 | IITA

300 | KLASS

310 | WHY

316 | ARO

324 | M4

332 | VIGO

340 | PLUS

346 | EXAGONUS

352 | COPA

358 | M8

366 | IRIS



CONTRACT
CONTRACT
CONTRACT

400 | MORK

410 | MINDY

420 | FRILL

430 | NO-FRILL

440 | LOOLA

446 | NUT

452 | HOLE

458 | HOP

466 | LINER

472 | NEST

480 | MR. JONES



SOFAS
SOFÁS
SOFAS

558 | SF



POUTRES:
BANCADAS:
BEAMS:

- LED
- BROS
- TOM



FINITIONS
ACABADOS
FINISHES

574 | TISSU / TAPIZADOS / UPHOLSTERY

Up

Cette gamme de bureaux opératifs au design contemporain et futuriste existe en deux versions: fixe ou réglable. La version réglable électriquement permet d'ajuster la hauteur au besoin de l'utilisateur.

Mesa operativa con un diseño moderno y futurista. Hay dos modelos a escoger: la fija o la elevable. La mesa elevable dispone de un sistema eléctrico que permite adaptar la altura de la mesa según las necesidades del usuario.

This office table has a modern and futurist look. There are two options: fixed or height adjustable frame. Each user can choose its favorite table height lifting the desk with an electric engine.

PLATEAUX / SOBRE / DESK TOP

Mélamine / Melamina / Melamine: 25 mm
Stratifié / Estratificado / Stratified: 13 mm
Phénolique / Fenólico / Phenolic:

Chant en ABS / Canto ABS / ABS edges

STRUCTURE / ESTRUCTURA / FRAME

Acier: 70 x 70 x 2 mm
Acero:
Steel:



FINITION STRUCTURE / ACABADO ESTRUCTURA / FRAME FINISH

Peinture époxy
Pintura epoxi
Epoxy paint

HAUTEUR / ALTURA / HEIGHT

65 mm < 130 mm

OPTION / OPCIÓN / OPTION

Voile de fond / Faldón / Modesty panel

BUREAUX EN VIS
À VIS RÉGLABLES
EN HAUTEUR

MESAS
ENFRENTADAS
ELEVABLES

HEIGHT ADJUSTABLE
FACE TO FACE
DESKS

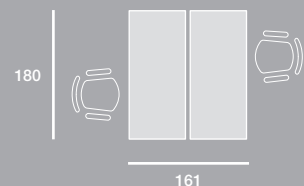

BUREAUX À
HAUTEUR FIXE
AVEC FORME

MESA
FIJA CON
FORMA

FIXED HEIGHT
DESK WITH
SHAPE

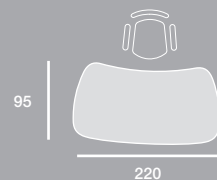

BUREAUX À
HAUTEUR FIXE
AVEC CRÉDENCE

MESA FIJA
INDIVIDUAL
CON CREDENCIA

FIXED HEIGHT
DESK WITH
SIDE CREDENZA

Combinable avec caissons et crédences OH-SYSTEMS.
Combinable con cajoneras y credencias OH-SYSTEMS.
Combine with OH-SYSTEMS pedestals and credenzas.

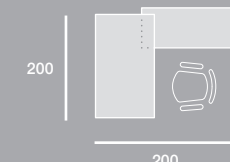

ENSEMBLE DE
BUREAUX RÉGLABLES
EN HAUTEUR

CONJUNTO
DE MESAS
ELEVABLES

HEIGHT ADJUSTABLE
FACE TO FACE
DESKS



Plateau coulissant sur 14 cm.
El sobre puede deslizarse 14 cm.
Sliding top 14 cm.

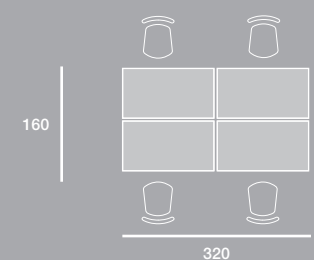

| TABLES DE
RÉUNION

| MESAS DE
REUNIÓN

| MEETING
TABLES

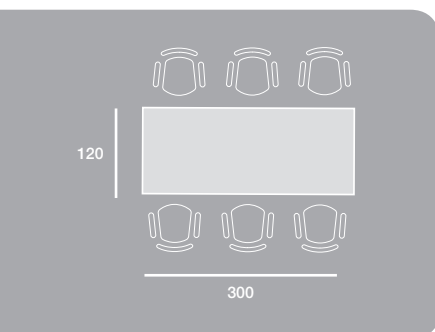

MODÈLES | VARIANTES | VERSIONS

RÉGLABLE EN HAUTEUR / REGULABLE EN ALTURA / ADJUSTABLE HEIGHT



MODÈLE / VARIANTES / VERSIONS	DIMENSIONS / MEDIDAS / MEASUREMENTS	RÉFÉRENCE / REFERENCIA / CODE		
		Argent Plata Silver RAL 9006	Blanc Blanco White RAL 9016	Graphite Grafito Graphite RAL 7022
 Bureau individuel Mesa rectangular Rectangular desk	220 x 80 cm 200 x 80 cm 180 x 80 cm 160 x 80 cm 140 x 80 cm	591.100.- 591.101.- 591.102.- 591.103.- 591.104.-	591.200.- 591.201.- 591.202.- 591.203.- 591.204.-	591.300.- 591.301.- 591.302.- 591.303.- 591.304.-
 Bureau individuel avec forme Mesa con forma Shaped executive table	220 x 80 cm 200 x 80 cm	591.130.- 591.131.-	591.230.- 591.231.-	591.330.- 591.331.-
 Bureau 120° Mesa 120° 120° desk	120°	591.110.-	591.210.-	591.310.-
 Bureaux en vis à vis Mesas enfrentadas Face to face desks	180 x 164 cm 160 x 164 cm 140 x 164 cm	591.120.- 591.121.- 591.122.-	591.220.- 591.221.- 591.222.-	591.320.- 591.321.- 591.322.-
 UP & DOWN	UP & DOWN	ES DE FR 1.591.058.000	CH 1.591.060.000	US UK 1.591.059.000 1.591.057.000
 BOÎTIER MÉMOIRE / PROGRAMABLE / PROGRAMMABLE	BOÎTIER MÉMOIRE / PROGRAMABLE / PROGRAMMABLE	1.591.062.000	1.591.064.000	1.591.063.000 1.591.061.000

Type de boîtier réglage hauteur pour chaque plateau
Controlador digital para cada sobre
Digital display for each desk top

FINITIONS | ACABADOS | FINISHES

PLATEAUX / SOBRE / DESK TOP

053	Blanc Blanco White	054	Gris Gris Grey	055	Hêtre Haya Beech	061	Chêne Moyen Roble Maple	062	Poirier Peral Pear
116	Wengué Wengue Wengue	103	Acacia Clair Acacia Clara Light Acacia	104	Acacia Foncé Acacia Oscura Dark Acacia	105	Zebrano Zebrano Zebrano		

HAUTEUR FIXE / FIJAS / FIXED HEIGHT



MODÈLE / VARIANTES / VERSIONS	DIMENSIONS / MEDIDAS / MEASUREMENTS	RÉFÉRENCE / REFERENCIA / CODE		
		Argent Plata Silver RAL 9006	Blanc Blanco White RAL 9016	Graphite Grafito Graphite RAL 7022
 Bureau individuel Mesa rectangular Rectangular desk	220 x 80 cm 200 x 80 cm 180 x 80 cm 160 x 80 cm 140 x 80 cm	591.140.- 591.141.- 591.150.- 591.151.- 591.152.-	591.240.- 591.241.- 591.250.- 591.251.- 591.252.-	591.340.- 591.341.- 591.350.- 591.351.- 591.352.-
 Bureau rectangulaire pour crédence Mesa rectangular con credencia Executive table with side credenza	200 x 80 cm	591.142.-	591.242.-	591.342.-
 Bureau individuel avec forme Mesa con forma Shaped executive table	220 x 80 cm 200 x 80 cm	591.160.- 591.161.-	591.260.- 591.261.-	591.360.- 591.361.-
 Bureau avec forme pour crédence Mesa con forma con credencia Shaped executive table with side credenza	200 x 80 cm	591.162.-	591.262.-	591.362.-
 Bureau 120° Mesa 120° 120° desk	120°	591.153.-	591.253.-	591.353.-
 Bureaux en vis à vis Mesas enfrentadas Face to face desks	180 x 164 cm 160 x 164 cm 140 x 164 cm	591.154.- 591.155.- 591.156.-	591.254.- 591.255.- 591.256.-	591.354.- 591.355.- 591.356.-
 Table de réunion rectangulaire Mesa de reunión rectangular Rectangular meeting table	220 x 100 cm 200 x 100 cm	594.100.- 594.101.-	594.200.- 594.201.-	594.300.- 594.301.-
 Table de réunion forme tonneau Mesa de reunión tonel Barrel meeting table	220 x 100 cm 200 x 100 cm	594.110.- 594.111.-	594.210.- 594.211.-	594.310.- 594.311.-

| COMPLÉMENTS | COMPLEMENTOS | COMPLEMENTS



MODÈLE / VARIANTES / VERSIONS	DIMENSIONS / MEDIDAS / MEASUREMENTS	RÉFÉRENCE / REFERENCIA / CODE
<p>Retour secrétaire Ala taquígrafa Return</p>	À droite / Derecha / Right 100 x 60 cm 80 x 60 cm	591.170.-.- 591.172.-.- 591.270.-.- 591.272.-.- 591.370.-.- 591.372.-.-
	À gauche / Izquierda / Left 100 x 60 cm 80 x 60 cm	591.171.-.- 591.173.-.- 591.271.-.- 591.273.-.- 591.371.-.- 591.373.-.-
<p>Bureau secrétaire Mesa taquígrafa Shorthand desk</p>	100 x 60 cm	591.174.-.- 591.274.-.- 591.374.-.-

| FINITIONS | ACABADOS | FINISHES

PLATEAUX / SOBRE / DESK TOP

053	Blanc Blanco White	054	Gris Gris Grey	055	Hêtre Haya Beech	061	Chêne Moyen Roble Maple	062	Poirier Peral Pear
116	Wengué Wengue	103	Acacia Clair Acacia Clara Light Acacia	104	Acacia Foncé Acacia Oscura Dark Acacia	105	Zebrano Zebrano		

| CLOISONNETTES FRONTALES | PLAFONES | FRONT SCREENS

1 NIVEAU / 1 NIVEL / 1 LEVEL

2 NIVEAUX / 2 NIVELES / 2 LEVELS

MODÈLE / VARIANTES / VERSIONS	L.	RÉFÉRENCE / REFERENCIA / CODE	MODÈLE / VARIANTES / VERSIONS	L.	RÉFÉRENCE / REFERENCIA / CODE
<p>Mélamine Melamina Melamine</p>	Indiv.	RAL 9006 RAL 9016 RAL 7022	<p>Mélamine avec rail Melamina con guía Melamine with guide</p>	Indiv.	RAL 9006 RAL 9016 RAL 7022
	180 cm	386.008.-.- 386.108.-.- 386.208.-.-		180 cm	386.021.-.- 386.121.-.- 386.221.-.-
	160 cm	386.009.-.- 386.109.-.- 386.209.-.-		160 cm	386.022.-.- 386.122.-.- 386.222.-.-
	140 cm	386.010.-.- 386.110.-.- 386.210.-.-		140 cm	386.023.-.- 386.123.-.- 386.223.-.-
	Vis à vis / Enfrentadas / Face to face			Vis à vis / Enfrentadas / Face to face	
	180 cm	596.110.-.- 596.210.-.- 596.310.-.-		180 cm	596.120.-.- 596.220.-.- 596.320.-.-
	160 cm	596.111.-.- 596.211.-.- 596.311.-.-		160 cm	596.121.-.- 596.221.-.- 596.321.-.-
	140 cm	596.112.-.- 596.212.-.- 596.312.-.-		140 cm	596.122.-.- 596.222.-.- 596.322.-.-
	120°			120°	
	100 cm	386.012.-.- 386.112.-.- 386.212.-.-		100 cm	386.025.-.- 386.125.-.- 386.225.-.-
<p>Mélamine avec rail Melamina con guía Melamine with guide</p>	Indiv.		<p>Mélamine avec rail Melamina con guía Melamine with guide</p>	Indiv.	
	180 cm	596.152.-.- 596.252.-.- 596.352.-.-		180 cm	596.155.-.- 596.255.-.- 596.355.-.-
	160 cm	596.153.-.- 596.253.-.- 596.353.-.-		160 cm	596.156.-.- 596.256.-.- 596.356.-.-
	140 cm	596.154.-.- 596.254.-.- 596.354.-.-		140 cm	596.157.-.- 596.257.-.- 596.357.-.-
	Vis à vis / Enfrentadas / Face to face			Vis à vis / Enfrentadas / Face to face	
	180 cm	596.162.-.- 596.262.-.- 596.362.-.-		180 cm	596.165.-.- 596.265.-.- 596.365.-.-
	160 cm	596.163.-.- 596.263.-.- 596.363.-.-		160 cm	596.166.-.- 596.266.-.- 596.366.-.-
	140 cm	596.164.-.- 596.264.-.- 596.364.-.-		140 cm	596.167.-.- 596.267.-.- 596.367.-.-
	120°			120°	
	100 cm	596.172.-.- 596.272.-.- 596.372.-.-		100 cm	596.173.-.- 596.273.-.- 596.373.-.-

FINITIONS ACABADOS FINISHES

007	Graphite Grafito Graphite	051	Argent Plata Silver
053	Blanc Blanco White	054	Gris Gris Grey
055	Hêtre Haya Beech	061	Chêne Moyen Roble Maple
062	Poirier Peral Pear	116	Wengué Wengue
103	Acacia Clair Acacia Clara Light Acacia	104	Acacia Foncé Acacia Oscura Dark Acacia
105	Zebrano Zebrano		

FINITIONS ACABADOS FINISHES

204	Graphite Grafito Graphite	088	Argent Plata Silver
081	Blanc Blanco White	197	Gris Gris Grey
198	Hêtre Haya Beech	199	Chêne Moyen Roble Maple
200	Poirier Peral Pear	202	Wengué Wengue
103	Acacia Clair Acacia Clara Light Acacia	104	Acacia Foncé Acacia Oscura Dark Acacia
105	Zebrano Zebrano		



Portique
Pórtico
Silver toolbar

180 cm 596.182.111
160 cm 596.183.111
140 cm 596.184.111

| CLOISONNETTES FRONTALES | PLAFONES | FRONT SCREENS

1 NIVEAU / 1 NIVEL / 1 LEVEL

2 NIVEAUX / 2 NIVELES / 2 LEVELS

MODÈLE / VARIANTES / VERSIONS	L.	RÉFÉRENCE / REFERENCIA / CODE		
		RAL 9006	RAL 9016	RAL 7022
	Indiv.			
	180 cm	386.008.000	386.108.000	386.208.000
	160 cm	386.009.000	386.109.000	386.209.000
	140 cm	386.010.000	386.110.000	386.210.000
Tissu Tapizado Upholstered	Vis à vis / Enfrentadas / Face to face			
	180 cm	596.110.000	596.210.000	596.310.000
	160 cm	596.111.000	596.211.000	596.311.000
	140 cm	596.112.000	596.212.000	596.312.000
	120°			
	100 cm	386.012.000	386.112.000	386.212.000
	Indiv.			
Acoustique Acústico Acoustic	180 cm	596.113.838	596.213.838	596.313.838
	160 cm	596.114.838	596.214.838	596.314.838
	140 cm	596.115.838	596.215.838	596.315.838
Acoustique Acústico Acoustic	Vis à vis / Enfrentadas / Face to face			
	180 cm	596.116.838	596.216.838	596.316.838
	160 cm	596.117.838	596.217.838	596.317.838
	140 cm	596.118.838	596.218.838	596.318.838
Acoustique Acústico Acoustic	120°			
	100 cm	596.119.838	596.219.838	596.319.838

MODÈLE / VARIANTES / VERSIONS	L.	RÉFÉRENCE / REFERENCIA / CODE		
		RAL 9006	RAL 9016	RAL 7022
	Indiv.			
	180 cm	386.021.000	386.121.000	386.221.000
	160 cm	386.022.000	386.122.000	386.222.000
	140 cm	386.023.000	386.123.000	386.223.000
Tissu Tapizado Upholstered	Vis à vis / Enfrentadas / Face to face			
	180 cm	596.120.000	596.220.000	596.320.000
	160 cm	596.121.000	596.221.000	596.321.000
	140 cm	596.122.000	596.222.000	596.322.000
	120°			
	100 cm	386.025.000	386.125.000	386.225.000
	Indiv.			
Tissu avec rail Tapizado con guía Upholstered with guide	180 cm	596.155.000	596.255.000	596.355.000
	160 cm	596.156.000	596.256.000	596.356.000
	140 cm	596.157.000	596.257.000	596.357.000
Tissu avec rail Tapizado con guía Upholstered with guide	Vis à vis / Enfrentadas / Face to face			
	180 cm	596.165.000	596.265.000	596.365.000
	160 cm	596.166.000	596.266.000	596.366.000
	140 cm	596.167.000	596.267.000	596.367.000
Tissu avec rail Tapizado con guía Upholstered with guide	120°			
	100 cm	596.173.000	596.273.000	596.373.000

FINITIONS ACABADOS FINISHES Cf. page 574 Ver pagina 574 See page 574

FINITIONS ACABADOS FINISHES Cf. page 574 Ver pagina 574 See page 574

	Indiv.			
	180 cm	386.008.---	386.108.---	386.208.---
	160 cm	386.009.---	386.109.---	386.209.---
	140 cm	386.010.---	386.110.---	386.210.---
Méthacrylate Metacrilato Methacrylate	Vis à vis / Enfrentadas / Face to face			
	180 cm	596.110.---	596.210.---	596.310.---
	160 cm	596.111.---	596.211.---	596.311.---
	140 cm	596.112.---	596.212.---	596.312.---
Méthacrylate Metacrilato Methacrylate	120°			
	100 cm	386.012.---	386.112.---	386.212.---

	Indiv.			
	180 cm	386.021.---	386.121.---	386.221.---
	160 cm	386.022.---	386.122.---	386.222.---
	140 cm	386.023.---	386.123.---	386.223.---
Avec méthacrylate et tapissée Con metacrilato y tapizado With methacrylate and upholstered	Vis à vis / Enfrentadas / Face to face			
	180 cm	596.120.---	596.220.---	596.320.---
	160 cm	596.121.---	596.221.---	596.321.---
	140 cm	596.122.---	596.222.---	596.322.---
	120°			
	100 cm	386.025.---	386.125.---	386.225.---
	Indiv.			
Méthacrylate et tapissée avec rail Metacrilato y tapizado con guía Methacrylate and upholstered with guide	180 cm	596.155.---	596.255.---	596.355.---
	160 cm	596.156.---	596.256.---	596.356.---
	140 cm	596.157.---	596.257.---	596.357.---
Méthacrylate et tapissée avec rail Metacrilato y tapizado con guía Methacrylate and upholstered with guide	Vis à vis / Enfrentadas / Face to face			
	180 cm	596.165.---	596.265.---	596.365.---
	160 cm	596.166.---	596.266.---	596.366.---
	140 cm	596.167.---	596.267.---	596.367.---
Méthacrylate et tapissée avec rail Metacrilato y tapizado con guía Methacrylate and upholstered with guide	120°			
	100 cm	596.173.---	596.273.---	596.373.---

FINITIONS ACABADOS FINISHES 411 Transparent Transparente Clear

412 Blanc opaque Translúcido Translucent

FINITIONS ACABADOS FINISHES 406 Transparent Transparente Clear

427 Blanc opaque Translúcido Translucent



star

La gamme STAR est le fruit de l'évolution de nos recherches et système de développement.

STAR es, sin duda, una apuesta de futuro en el desarrollo y evolución del mobiliario de oficina. Fruto de la evolución del sistema de desarrollo y estudio, nace este programa.

STAR is the future in office furniture. It was born as a result of ongoing research and development systems.

PLATEAUX / SOBRE / DESK TOP

Mélamine / Melamina / Melamine: 25 mm
Stratifié / Estratificado / Stratified:
Phénolique / Fenólico / Phenolic: 13 mm
Verre / Vidrio / Glass: 10 mm
Chant en ABS / Canto ABS / ABS edges

STRUCTURE / ESTRUCTURA / FRAME

Acier: 50 x 50 x 1,8 mm
Acero: 60 x 60 x 1,5 mm
Steel: 60 x 60 x 1,5 mm



prof./depth 80/60 prof./depth 100/120

FINITION STRUCTURE / ACABADO ESTRUCTURA / FRAME FINISH

Peinture époxy
Pintura epoxi
Epoxy paint

HAUTEUR / ALTURA / HEIGHT

73 mm

OPTION / OPCIÓN / OPTION

Voile de fond / Faldón / Modesty panel

BUREAUX AVEC
PIÉTEMENT FERMÉ

MESAS CON
LATERAL CERRADO

DESKS WITH
LOOP LEG

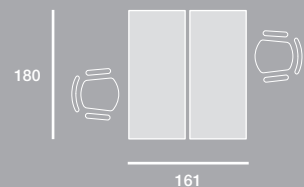

BUREAUX AVEC
PIÉTEMENT
OUVERT

MESAS CON
LATERAL
ABIERTO

U-SHAPE
FRAME



BUREAUX
AVEC RETOUR

MESAS
CON ALA

DESKS WITH
RETURN

Combinable avec caissons et crédences OH-SYSTEMS.
Combinable con cajoneras y credencias OH-SYSTEMS.
Combine with OH-SYSTEMS pedestals and credenzas.

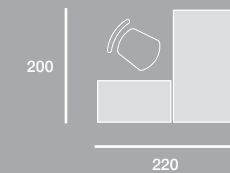
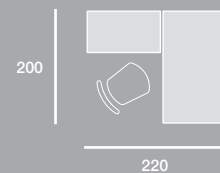



Plateau coulissant sur 14 cm.
El sobre puede deslizarse 14 cm.
Sliding top 14 cm.

BUREAUX
EN VIS À VIS
AVEC CRÉDENCE

MESAS
ENFRENTADAS
CON CREDENCIA

FACE TO FACE
DESKS WITH
SIDE CREDENZA

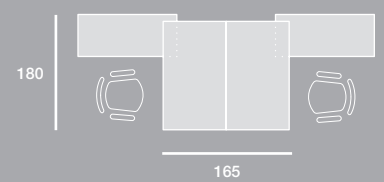

| TABLES DE
| RÉUNION

| MESAS DE
| REUNIÓN



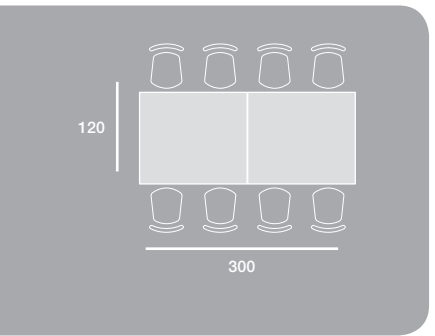

| MEETING
| TABLES



MODÈLES | VARIANTES | VERSIONS



PIÉTEMENT OUVERT / PATA ABIERTA / U-SHAPE LEG

Argent Plata Silver RAL 9006
Blanc Blanco White RAL 9016
Graphite Grafito Graphite RAL 7022

MODÈLE / VARIANTES / VERSIONS	TYPE / TIPO / TYPE	DIMENSIONS / MEDIDAS / MEASUREMENTS	RÉFÉRENCE / REFERENCIA / CODE					
			■	■	■			
 Bureau individuel Mesa individual Individual desks		220 x 100 cm 200 x 100 cm	351.100.-.. 351.101.-..	351.200.-.. 351.201.-..	351.300.-.. 351.301.-..			
		180 x 80 cm 160 x 80 cm 140 x 80 cm 120 x 80 cm 100 x 80 cm 80 x 80 cm	351.102.-.. 351.103.-.. 351.104.-.. 351.105.-.. 351.106.-.. 351.107.-..	351.202.-.. 351.203.-.. 351.204.-.. 351.205.-.. 351.206.-.. 351.207.-..	351.302.-.. 351.303.-.. 351.304.-.. 351.305.-.. 351.306.-.. 351.307.-..			
	 Bureau individuel pour crédence Mesa individual con credencia Individual desks with side credenza	À Droite / Derecha / Right	160 x 160 cm 200 x 100 cm 180 x 80 cm 160 x 80 cm	351.132.-.. 351.134.-.. 351.136.-.. 351.138.-..	351.232.-.. 351.234.-.. 351.236.-.. 351.238.-..	351.332.-.. 351.334.-.. 351.336.-.. 351.338.-..		
		À Gauche / Izquierda / Left	160 x 160 cm 200 x 100 cm 180 x 80 cm 160 x 80 cm	351.133.-.. 351.135.-.. 351.137.-.. 351.139.-..	351.233.-.. 351.235.-.. 351.237.-.. 351.239.-..	351.333.-.. 351.335.-.. 351.337.-.. 351.339.-..		
				360 x 80 cm 320 x 80 cm 280 x 80 cm 240 x 80 cm 200 x 80 cm 160 x 80 cm	351.108.-.. 351.109.-.. 351.110.-.. 351.111.-.. 351.112.-.. 351.113.-..	351.208.-.. 351.209.-.. 351.210.-.. 351.211.-.. 351.212.-.. 351.213.-..	351.308.-.. 351.309.-.. 351.310.-.. 351.311.-.. 351.312.-.. 351.313.-..	
	 Bureaux alignés Mesas lineales Side by side desks	4 bureaux / mesas / desktops	Type "A" / Tipo "A" / Type "A"	360 x 165 cm 320 x 165 cm 280 x 165 cm 200 x 165 cm	351.120.-.. 351.121.-.. 351.122.-.. 351.123.-..	351.220.-.. 351.221.-.. 351.222.-.. 351.223.-..	351.320.-.. 351.321.-.. 351.322.-.. 351.323.-..	
Type "B" / Tipo "B" / Type "B"			360 x 161 cm 320 x 161 cm 280 x 161 cm 200 x 161 cm	358.120.-.. 358.121.-.. 358.122.-.. 358.123.-..	358.220.-.. 358.221.-.. 358.222.-.. 358.223.-..	358.320.-.. 358.321.-.. 358.322.-.. 358.323.-..		
Type "A" / Tipo "A" / Type "A"			180 x 165 cm 160 x 165 cm 140 x 165 cm 100 x 165 cm	351.128.-.. 351.129.-.. 351.130.-.. 351.131.-..	351.228.-.. 351.229.-.. 351.230.-.. 351.231.-..	351.328.-.. 351.329.-.. 351.330.-.. 351.331.-..		
Type "B" / Tipo "B" / Type "B"			180 x 161 cm 160 x 161 cm 140 x 161 cm 100 x 161 cm	358.128.-.. 358.129.-.. 358.130.-.. 358.131.-..	358.228.-.. 358.229.-.. 358.230.-.. 358.231.-..	358.328.-.. 358.329.-.. 358.330.-.. 358.331.-..		
Bureaux en vis à vis Mesas enfrentadas Face to face desks			2 bureaux / mesas / desktops	Type "A" / Tipo "A" / Type "A"	180 x 165 cm 160 x 165 cm 140 x 165 cm 100 x 165 cm	351.128.-.. 351.129.-.. 351.130.-.. 351.131.-..	351.228.-.. 351.229.-.. 351.230.-.. 351.231.-..	351.328.-.. 351.329.-.. 351.330.-.. 351.331.-..
				Type "B" / Tipo "B" / Type "B"	180 x 161 cm 160 x 161 cm 140 x 161 cm 100 x 161 cm	358.128.-.. 358.129.-.. 358.130.-.. 358.131.-..	358.228.-.. 358.229.-.. 358.230.-.. 358.231.-..	358.328.-.. 358.329.-.. 358.330.-.. 358.331.-..
 Bureaux en vis à vis pour crédence Mesas enfrentadas para credencia Face to face desks with side credenza	4 bureaux / mesas / desktops	Type "A" / Tipo "A" / Type "A"	360 x 165 cm 320 x 165 cm 280 x 165 cm	351.140.-.. 351.141.-.. 351.142.-..	351.240.-.. 351.241.-.. 351.242.-..	351.340.-.. 351.341.-.. 351.342.-..		
		Type "B" / Tipo "B" / Type "B"	360 x 161 cm 320 x 161 cm 280 x 161 cm	358.140.-.. 358.141.-.. 358.142.-..	358.240.-.. 358.241.-.. 358.242.-..	358.340.-.. 358.341.-.. 358.342.-..		
		Type "A" / Tipo "A" / Type "A"	180 x 165 cm 160 x 165 cm 140 x 165 cm	351.143.-.. 351.144.-.. 351.145.-..	351.243.-.. 351.244.-.. 351.245.-..	351.343.-.. 351.344.-.. 351.345.-..		
	2 bureaux / mesas / desktops	Type "B" / Tipo "B" / Type "B"	180 x 161 cm 160 x 161 cm 140 x 161 cm	358.143.-.. 358.144.-.. 358.145.-..	358.243.-.. 358.244.-.. 358.245.-..	358.343.-.. 358.344.-.. 358.345.-..		
		Tables de réunion Mesas de reunión Meeting tables	450 x 120 cm 300 x 120 cm 250 x 120 cm 200 x 120 cm 120 x 120 cm	354.104.-.. 354.103.-.. 354.102.-.. 354.101.-.. 354.100.-..	354.204.-.. 354.203.-.. 354.202.-.. 354.201.-.. 354.200.-..	354.304.-.. 354.303.-.. 354.302.-.. 354.301.-.. 354.300.-..		
			480 x 160 cm 320 x 160 cm 160 x 160 cm	354.107.-.. 354.106.-.. 354.105.-..	354.207.-.. 354.206.-.. 354.105.-..	354.307.-.. 354.306.-.. 354.305.-..		

PIÉTEMENT FERMÉ / PATA CERRADA / LOOP LEGS

Argent Plata Silver RAL 9006
Blanc Blanco White RAL 9016
Graphite Grafito Graphite RAL 7022

MODÈLE / VARIANTES / VERSIONS	TYPE / TIPO / TYPE	DIMENSIONS / MEDIDAS / MEASUREMENTS	RÉFÉRENCE / REFERENCIA / CODE					
			■	■	■			
 Bureau individuel Mesa individual Individual desks		220 x 100 cm 200 x 100 cm	357.100.-.. 357.101.-..	357.200.-.. 357.201.-..	357.300.-.. 357.301.-..			
		180 x 80 cm 160 x 80 cm 140 x 80 cm	357.102.-.. 357.103.-.. 357.104.-..	357.202.-.. 357.203.-.. 357.204.-..	357.302.-.. 357.303.-.. 357.304.-..			
 Bureaux en vis à vis Mesas enfrentadas Face to face desks	4 bureaux / mesas / desktops	Type "A" / Tipo "A" / Type "A"	360 x 165 cm 320 x 165 cm 280 x 165 cm 200 x 165 cm	357.107.-.. 357.108.-.. 357.109.-.. 357.110.-..	357.207.-.. 357.208.-.. 357.209.-.. 357.210.-..	357.307.-.. 357.308.-.. 357.309.-.. 357.310.-..		
		Type "B" / Tipo "B" / Type "B"	360 x 161 cm 320 x 161 cm 280 x 161 cm 200 x 161 cm	359.107.-.. 359.108.-.. 359.109.-.. 359.110.-..	359.207.-.. 359.208.-.. 359.209.-.. 359.210.-..	359.307.-.. 359.308.-.. 359.309.-.. 359.310.-..		
		Type "A" / Tipo "A" / Type "A"	180 x 165 cm 160 x 165 cm 140 x 165 cm 100 x 165 cm	357.115.-.. 357.116.-.. 357.117.-.. 357.118.-..	357.215.-.. 357.216.-.. 357.217.-.. 357.218.-..	357.315.-.. 357.316.-.. 357.317.-.. 357.318.-..		
	2 bureaux / mesas / desktops	Type "B" / Tipo "B" / Type "B"	180 x 161 cm 160 x 161 cm 140 x 161 cm 100 x 161 cm	359.115.-.. 359.116.-.. 359.117.-.. 359.118.-..	359.215.-.. 359.216.-.. 359.217.-.. 359.218.-..	359.315.-.. 359.316.-.. 359.317.-.. 359.318.-..		
		Bureaux en vis à vis pour crédence Mesas enfrentadas para credencia Face to face desks with side credenza	2 bureaux / mesas / desktops	Type "A" / Tipo "A" / Type "A"	180 x 165 cm 160 x 165 cm 140 x 165 cm	357.119.-.. 357.120.-.. 357.121.-..	357.219.-.. 357.220.-.. 357.221.-..	357.319.-.. 357.320.-.. 357.321.-..
				Type "B" / Tipo "B" / Type "B"	180 x 161 cm 160 x 161 cm 140 x 161 cm	359.119.-.. 359.120.-.. 359.121.-..	359.219.-.. 359.220.-.. 359.221.-..	359.319.-.. 359.320.-.. 359.321.-..

FINITIONS | ACABADOS | FINISHES

PLATEAUX / SOBRE / DESK TOP

053	Blanc Blanco White	054	Gris Gris Grey	055	Hêtre Haya Beech	061	Chêne Moyen Roble Maple	062	Poirier Peral Pear
116	Wengué Wengue Wengue	103	Acacia Clair Acacia Clara Light Acacia	104	Acacia Foncé Acacia Oscura Dark Acacia	105	Zebrano Zebrano Zebrano		

| COMPLÉMENTS | COMPLEMENTOS | COMPLEMENTS



MODÈLE / VARIANTES / VERSIONS	DIMENSIONS / MEDIDAS / MEASUREMENTS	RÉFÉRENCE / REFERENCIA / CODE		
	120 x 60 cm 80 x 60 cm	351.191... 351.190...	351.291... 351.290...	351.391... 351.390...
	120 x 60 cm 80 x 60 cm	357.191... 357.190...	357.291... 357.290...	357.391... 357.390...
	158 x 118 cm	351.196...	351.296...	351.396...
	165 x 70 cm	351.198...	351.298...	351.398...
	165 x 40 cm	351.199...	351.299...	351.399...

| FINITIONS | ACABADOS | FINISHES

PLATEAUX / SOBRE / DESK TOP

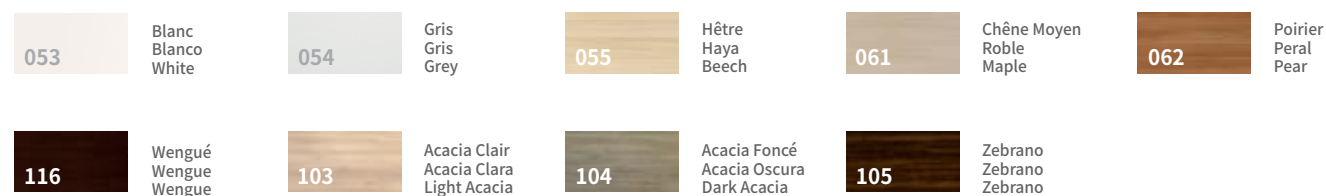

| COMPLÉMENTS | COMPLEMENTOS | COMPLEMENTS

MODÈLE / VARIANTES / VERSIONS	DIMENSIONS / MEDIDAS / MEASUREMENTS	RÉFÉRENCE / REFERENCIA / CODE		
	Pour bureaux / para mesas / for desks: 220 cm 200 cm 180 cm 160 cm 140 cm 120 cm 100 cm 80 cm	Mélamine / Melamina / Melamine 1.351.702... 1.351.704... 1.351.706... 1.351.708... 1.351.710... 1.351.712... 1.351.714... 1.351.716...		
	Pour bureaux / para mesas / for desks: 220 cm 200 cm 180 cm 160 cm 140 cm 120 cm 100 cm 80 cm	Métal / Metal / Metal 1.351.720... 1.351.721... 1.351.722... 1.351.723... 1.351.724... 1.351.725... 1.351.726... 1.351.727...		
	Pour bureaux / para mesas / for desks: 220 cm 200 cm 180 cm 160 cm 140 cm 120 cm 100 cm 80 cm	Indiv. 1.356.300... 1.356.301... 1.356.302... 1.356.303... 1.356.304... 1.356.305... 1.356.306... 1.356.307...		
	Pour tables de réunion et bureaux en vis à vis / para mesas de reunión y enfrentadas / for meeting tables and face to face desks 250 cm 200 cm 180 cm 160 cm 140 / 150 cm 140 cm 120 cm 80 cm	Double / Doble / Double 1.356.310... 1.356.311... 1.356.312... 1.356.313... 1.356.314... 1.356.315... 1.356.316... 1.356.317...		



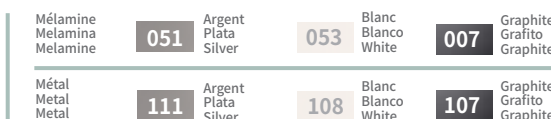





FINITIONS ACABADOS FINISHES



| CLOISONNETTES FRONTALES | PLAFONES | FRONT SCREENS

1 NIVEAU / 1 NIVEL / 1 LEVEL

2 NIVEAUX / 2 NIVELES / 2 LEVELS

MODÈLE / VARIANTES / VERSIONS	L.	RÉFÉRENCE / REFERENCIA / CODE			MODÈLE / VARIANTES / VERSIONS	L.	RÉFÉRENCE / REFERENCIA / CODE		
	Indiv.	 RAL 9006	 RAL 9016	 RAL 7022		Indiv.	 RAL 9006	 RAL 9016	 RAL 7022
	180 cm	356.001.-	356.101.-	356.201.-		180 cm	356.013.-	356.113.-	356.213.-
	160 cm	356.002.-	356.102.-	351.202.-		160 cm	356.014.-	356.114.-	356.214.-
	140 cm	356.003.-	356.103.-	356.203.-		140 cm	356.015.-	356.115.-	356.215.-
	120 cm	356.004.-	356.104.-	356.204.-		120 cm	356.016.-	356.116.-	356.216.-
	100 cm	356.005.-	356.105.-	356.205.-		100 cm	356.017.-	356.117.-	356.217.-
	80 cm	356.006.-	356.106.-	356.206.-		80 cm	356.018.-	356.118.-	356.218.-
Vis à vis / Enfrentadas / Face to face				Vis à vis / Enfrentadas / Face to face					
180 cm	356.007.-	356.107.-	356.207.-	180 cm	356.021.-	356.121.-	356.221.-		
160 cm	356.008.-	356.108.-	356.208.-	160 cm	356.022.-	356.122.-	356.222.-		
140 cm	356.009.-	356.109.-	356.209.-	140 cm	356.023.-	356.123.-	356.223.-		
120 cm	356.010.-	356.110.-	356.210.-	120 cm	356.024.-	356.124.-	356.224.-		
100 cm	356.011.-	356.111.-	356.211.-	100 cm	356.025.-	356.125.-	356.225.-		
80 cm	356.012.-	356.112.-	356.212.-	80 cm	356.026.-	356.126.-	356.226.-		

Mélamine
Melamina
Melamine

Mélamine
Melamina
Melamine

FINITIONS ACABADOS FINISHES

	Blanc Blanco White		Gris Gris Grey		Argent Plata Silver
	Chêne Moyen Roble Maple		Poirier Peral Pear		Wengué Wengue Wengue
	Acacia Clair Acacia Clara Light Acacia		Acacia Foncé Acacia Oscura Dark Acacia		Zebrano Zebrano Zebrano

FINITIONS ACABADOS FINISHES

	Blanc Blanco White		Gris Gris Grey		Argent Plata Silver
	Chêne Moyen Roble Maple		Poirier Peral Pear		Wengué Wengue Wengue
	Acacia Clair Acacia Clara Light Acacia		Acacia Foncé Acacia Oscura Dark Acacia		Zebrano Zebrano Zebrano

	Indiv.			
	180 cm	356.001.000	356.101.000	356.201.000
	160 cm	356.002.000	356.102.000	351.202.000
	140 cm	356.003.000	356.103.000	356.203.000
	120 cm	356.004.000	356.104.000	356.204.000
	100 cm	356.005.000	356.105.000	356.205.000
	80 cm	356.006.000	356.106.000	356.206.000
Vis à vis / Enfrentadas / Face to face				
180 cm	356.007.000	356.107.000	356.207.000	
160 cm	356.008.000	356.108.000	356.208.000	
140 cm	356.009.000	356.109.000	356.209.000	
120 cm	356.010.000	356.110.000	356.210.000	
100 cm	356.011.000	356.111.000	356.211.000	
80 cm	356.012.000	356.112.000	356.212.000	

Tissu
Tapizado
Upholstered

	Indiv.			
	180 cm	356.013.000	356.113.000	356.213.000
	160 cm	356.014.000	356.114.000	356.214.000
	140 cm	356.015.000	356.115.000	356.215.000
	120 cm	356.016.000	356.116.000	356.216.000
	100 cm	356.017.000	356.117.000	356.217.000
	80 cm	356.018.000	356.118.000	356.218.000
Vis à vis / Enfrentadas / Face to face				
180 cm	356.021.000	356.121.000	356.221.000	
160 cm	356.022.000	356.122.000	356.222.000	
140 cm	356.023.000	356.123.000	356.223.000	
120 cm	356.024.000	356.124.000	356.224.000	
100 cm	356.025.000	356.125.000	356.225.000	
80 cm	356.026.000	356.126.000	356.226.000	

Tissu
Tapizado
Upholstered

FINITIONS ACABADOS FINISHES



Cf. page 574
Ver página 574
See page 574

FINITIONS ACABADOS FINISHES



Cf. page 574
Ver página 574
See page 574

	Indiv.			
	180 cm	356.001.-	356.101.-	356.201.-
	160 cm	356.002.-	356.102.-	351.202.-
	140 cm	356.003.-	356.103.-	356.203.-
	120 cm	356.004.-	356.104.-	356.204.-
	100 cm	356.005.-	356.105.-	356.205.-
	80 cm	356.006.-	356.106.-	356.206.-
Vis à vis / Enfrentadas / Face to face				
180 cm	356.007.-	356.107.-	356.207.-	
160 cm	356.008.-	356.108.-	356.208.-	
140 cm	356.009.-	356.109.-	356.209.-	
120 cm	356.010.-	356.110.-	356.210.-	
100 cm	356.011.-	356.111.-	356.211.-	
80 cm	356.012.-	356.112.-	356.212.-	

Méthacrylate
Metacrilato
Methacrylate



	Indiv.			
	180 cm	356.013.-	356.113.-	356.213.-
	160 cm	356.014.-	356.114.-	356.214.-
	140 cm	356.015.-	356.115.-	356.215.-
	120 cm	356.016.-	356.116.-	356.216.-
	100 cm	356.017.-	356.117.-	356.217.-
	80 cm	356.018.-	356.118.-	356.218.-
Vis à vis / Enfrentadas / Face to face				
180 cm	356.021.-	356.121.-	356.221.-	
160 cm	356.022.-	356.122.-	356.222.-	
140 cm	356.023.-	356.123.-	356.223.-	
120 cm	356.024.-	356.124.-	356.224.-	
100 cm	356.025.-	356.125.-	356.225.-	
80 cm	356.026.-	356.126.-	356.226.-	

Avec méthacrylate et tapissée
Con metacrilato y tapizado
With methacrylate and upholstered

FINITIONS ACABADOS FINISHES

	Transparent Transparente Clear		Blanc opaque Translúcido Translucent
---	--------------------------------------	---	--

FINITIONS ACABADOS FINISHES

	Transparent Transparente Clear		Blanc opaque Translúcido Translucent
--	--------------------------------------	---	--



Cloisonnettes de 1 et 2 niveaux, acoustiques et avec rails pour y accrocher une grande variété d'accessoires et rendre votre poste de travail plus agréable.

Esta ampliación de la serie STAR facilita el crear un espacio de trabajo más cómodo. Separadores de uno y dos niveles, acústicos y con guías junto a una gran variedad de accesorios para hacer de las oficinas un lugar más agradable.

Best accessories to do more comfortable the workstation: one or two levels front screens (acoustics or with guide), toolbar with complements and a wide range of facilities that will make the workspace a better place.

MODULE / MÓDULO / LOW STORAGE

Mélamine / Melamina / Melamine: 25 mm
Stratifié / Estratificado / Stratified: 13 mm
Phénolique / Fenólico / Phenolic: 13 mm

Chant en ABS / Canto ABS / ABS edges

STRUCTURE / ESTRUCTURA / FRAME

Acier: 50 x 50 x 1,8 mm
Acero: 50 x 50 x 1,8 mm
Steel: 50 x 50 x 1,8 mm



FINITION STRUCTURE / ACABADO ESTRUCTURA / FRAME FINISH

Peinture époxy
Pintura epoxi
Epoxy paint

HAUTEUR / ALTURA / HEIGHT

Module simple	580 mm	Avec rangement supérieur	1391 mm
Módulo		Con altillo	
Low storage		High storage	

MEUBLE DE RANGEMENT DOUBLE

MÓDULO DOBLE

TWO FACES LOW STORAGE

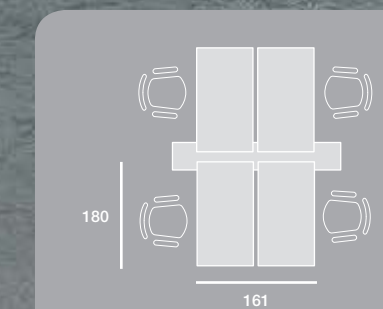



Obtuteur rond.
Tapa pasacables.
Round cable cover.



Poignée standard / Tirador estándar / Standard handle

Poignée variante / Tirador opcional / Optional handle

Tiroir DS disponible.
Cajón archivo disponible.
File drawer available.



MEUBLE AVEC
RANGEMENT SUPÉRIEUR

MÓDULO
CON ALTILLO

LOW AND HIGH
STORAGE

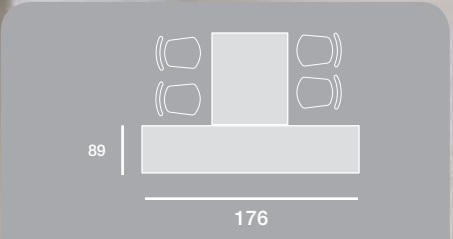

MEUBLE DE
RANGEMENT INDIVIDUEL

MÓDULO
INDIVIDUAL

INDIVIDUAL LOW
STORAGE

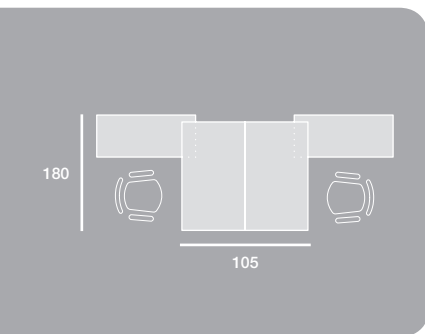



| CLOISONNETTES

| DIVISORIAS

| FRONT SCREENS



MODÈLES | VARIANTES | VERSIONS

PIÉTEMENT OUVERT / PATA ABIERTA / U-SHAPE LEG



MODÈLE / VARIANTES / VERSIONS	TYPE / TIPO / TYPE	DIMENSIONS / MEDIDAS / MEASUREMENTS	RÉFÉRENCE / REFERENCIA / CODE		
			Argent Plata Silver RAL 9006	Blanc Blanco White RAL 9016	Graphite Grafito Graphite RAL 7022
	À droite / Derecha / Right	180 x 80 cm 160 x 80 cm 140 x 80 cm	353.102.-.- 353.104.-.- 353.106.-.-	353.202.-.- 353.204.-.- 353.206.-.-	353.302.-.- 353.304.-.- 353.306.-.-
	À gauche / Izquierda / Left	180 x 80 cm 160 x 80 cm 140 x 80 cm	353.103.-.- 353.105.-.- 353.107.-.-	353.203.-.- 353.205.-.- 353.207.-.-	353.303.-.- 353.305.-.- 353.307.-.-
	À droite / Derecha / Right	180 x 60 cm 160 x 60 cm 140 x 60 cm	353.112.-.- 353.114.-.- 353.116.-.-	353.212.-.- 353.214.-.- 353.216.-.-	353.312.-.- 353.314.-.- 353.316.-.-
Bureau individuel Mesa individual Individual desks	À gauche / Izquierda / Left	180 x 60 cm 160 x 60 cm 140 x 60 cm	353.113.-.- 353.115.-.- 353.117.-.-	353.213.-.- 353.215.-.- 353.217.-.-	353.313.-.- 353.315.-.- 353.317.-.-

		180 x 165 cm 160 x 165 cm 140 x 165 cm	353.120.-.- 353.122.-.- 353.124.-.-	353.220.-.- 353.222.-.- 353.224.-.-	353.320.-.- 353.322.-.- 353.324.-.-
		180 x 125 cm 160 x 125 cm 140 x 125 cm	353.126.-.- 353.128.-.- 353.130.-.-	353.226.-.- 353.228.-.- 353.230.-.-	353.326.-.- 353.328.-.- 353.330.-.-
	Bureaux en vis à vis Mesas enfrentadas Face to face desks				

		180 x 160 cm 160 x 160 cm 140 x 160 cm	353.132.-.- 353.134.-.- 353.136.-.-	353.232.-.- 353.234.-.- 353.236.-.-	353.332.-.- 353.334.-.- 353.336.-.-
		180 x 160 cm 160 x 160 cm 140 x 160 cm	353.138.-.- 353.140.-.- 353.142.-.-	353.238.-.- 353.240.-.- 353.242.-.-	353.338.-.- 353.340.-.- 353.342.-.-
	Bureaux doubles en 1 seul plateau Mesa doble con 1 solo sobre Meeting table				

| FINITIONS | ACABADOS | FINISHES

PLATEAUX / SOBRES / DESK TOP

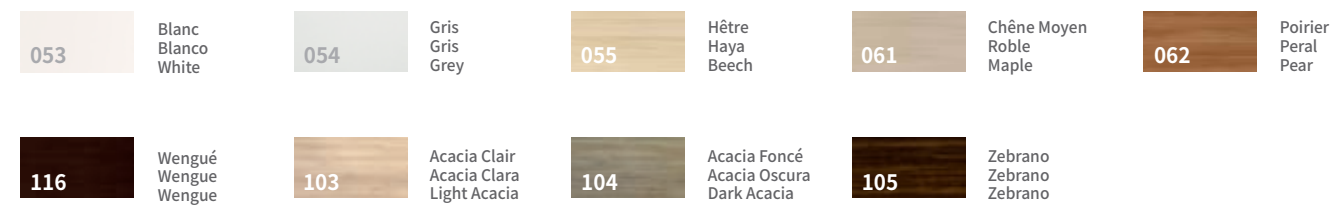

PIÉTEMENT FERMÉ / PATA CERRADA / LOOP LEGS

MODÈLE / VARIANTES / VERSIONS	TYPE / TIPO / TYPE	DIMENSIONS / MEDIDAS / MEASUREMENTS	RÉFÉRENCE / REFERENCIA / CODE		
			Argent Plata Silver RAL 9006	Blanc Blanco White RAL 9016	Graphite Grafito Graphite RAL 7022
	À droite / Derecha / Right	180 x 80 cm 160 x 80 cm 140 x 80 cm	357.132.-.- 357.134.-.- 357.136.-.-	357.232.-.- 357.234.-.- 357.236.-.-	357.332.-.- 357.334.-.- 357.336.-.-
	À gauche / Izquierda / Left	180 x 80 cm 160 x 80 cm 140 x 80 cm	357.133.-.- 357.135.-.- 357.137.-.-	357.233.-.- 357.235.-.- 357.237.-.-	357.333.-.- 357.335.-.- 357.337.-.-
	À droite / Derecha / Right	180 x 60 cm 160 x 60 cm 140 x 60 cm	357.142.-.- 357.144.-.- 357.146.-.-	357.242.-.- 357.244.-.- 357.246.-.-	357.342.-.- 357.344.-.- 357.346.-.-
Bureau individuel Mesa individual Individual desks	À gauche / Izquierda / Left	180 x 60 cm 160 x 60 cm 140 x 60 cm	357.143.-.- 357.145.-.- 357.147.-.-	357.243.-.- 357.245.-.- 357.247.-.-	357.343.-.- 357.345.-.- 357.347.-.-

		180 x 165 cm 160 x 165 cm 140 x 165 cm	357.154.-.- 357.155.-.- 357.156.-.-	357.254.-.- 357.255.-.- 357.256.-.-	357.354.-.- 357.355.-.- 357.356.-.-
		180 x 125 cm 160 x 125 cm 140 x 125 cm	357.157.-.- 357.158.-.- 357.159.-.-	357.257.-.- 357.258.-.- 357.259.-.-	357.357.-.- 357.358.-.- 357.359.-.-
	Bureaux en vis à vis Mesas enfrentadas Face to face desks				

		180 x 160 cm 160 x 160 cm 140 x 160 cm	357.162.-.- 357.164.-.- 357.166.-.-	357.262.-.- 357.264.-.- 357.266.-.-	357.362.-.- 357.364.-.- 357.366.-.-
		180 x 160 cm 160 x 160 cm 140 x 160 cm	357.168.-.- 357.170.-.- 357.172.-.-	357.268.-.- 357.270.-.- 357.272.-.-	357.368.-.- 357.370.-.- 357.372.-.-
	Bureaux doubles en 1 seul plateau Mesa doble con 1 solo sobre Meeting table				

| FINITIONS | ACABADOS | FINISHES

PLATEAUX / SOBRES / DESK TOP

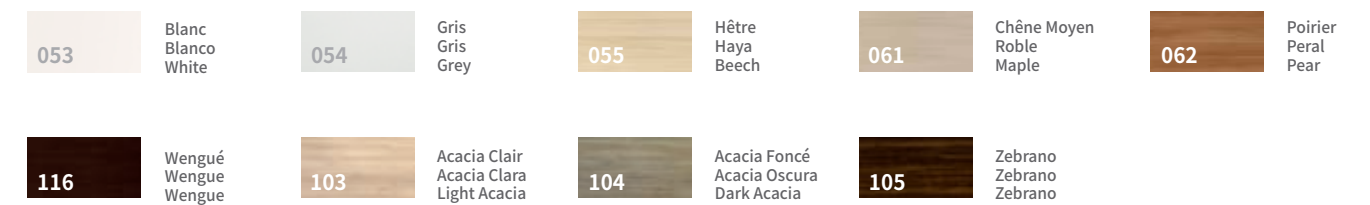



MODÈLES | VARIANTES | VERSIONS

MEUBLE DE RANGEMENT / MÓDULOS / LOW STORAGE

MODÈLE / VARIANTES / VERSIONS	TYPE / TIPO / TYPE	DIMENSIONS / MEDIDAS / MEASUREMENTS	RÉFÉRENCE / REFERENCIA / CODE		
	Individuel / Individual / Single face		2 tiroirs / Cajones / Drawers + 1 Porte coulissante / Puerta corredera / Sliding door	2 DS / Archivo / File + 1 Porte coulissante / Puerta corredera / Sliding door	2 Portes coulissantes / Puertas correderas / Sliding doors
	À droite / Derecha / Right	176,4 x 44,5 cm	362.001 - - -	362.003 - - -	362.005 - - -
	À gauche / Izquierda / Left	176,4 x 44,5 cm	362.002 - - -	362.004 - - -	
Type 1 Tipo 1 Type 1	Double / Doble / Two faces	176,4 x 89 cm	4 tiroirs / Cajones / Drawers + 2 Portes coulissantes / Puertas correderas / Sliding doors	2 DS / Archivo / File + 2 Portes coulissantes / Puertas correderas / Sliding doors	4 Portes coulissantes / Puertas correderas / Sliding doors
			362.010 - - -	362.011 - - -	362.012 - - -
	Individuel / Individual / Single face		2 tiroirs / Cajones / Drawers + 1 Porte coulissante / Puerta corredera / Sliding door	2 DS / Archivo / File + 1 Porte coulissante / Puerta corredera / Sliding door	2 Portes coulissantes / Puertas correderas / Sliding doors
	À droite / Derecha / Right	176,4 x 44,5 cm	362.030 - - -	362.032 - - -	362.034 - - -
	À gauche / Izquierda / Left	176,4 x 44,5 cm	362.031 - - -	362.033 - - -	
Type 2 Tipo 2 Type 2	Double / Doble / Two faces	176,4 x 89 cm	4 tiroirs / Cajones / Drawers + 2 Portes coulissantes / Puertas correderas / Sliding doors	2 DS / Archivo / File + 2 Portes coulissantes / Puertas correderas / Sliding doors	4 Portes coulissantes / Puertas correderas / Sliding doors
			362.036 - - -	362.037 - - -	362.038 - - -
	Individuel / Individual / Single face		2 tiroirs / Cajones / Drawers + 1 Porte coulissante / Puerta corredera / Sliding door	2 DS / Archivo / File + 1 Porte coulissante / Puerta corredera / Sliding door	2 Portes coulissantes / Puertas correderas / Sliding doors
	À droite / Derecha / Right	176,4 x 44,5 cm	362.040 - - -	362.042 - - -	362.044 - - -
	À gauche / Izquierda / Left	176,4 x 44,5 cm	362.041 - - -	362.043 - - -	
Type 3 (avec goulotte) Tipo 3 (con canal electrificación) Type 3 (with cable cover)	Double / Doble / Two faces	176,4 x 89 cm	4 tiroirs / Cajones / Drawers + 2 Portes coulissantes / Puertas correderas / Sliding doors	2 DS / Archivo / File + 2 Portes coulissantes / Puertas correderas / Sliding doors	4 Portes coulissantes / Puertas correderas / Sliding doors
			362.050 - - -	362.051 - - -	362.052 - - -

MODÈLES | VARIANTES | VERSIONS







































MEUBLES DE RANGEMENT SUPÉRIEURS / ALTILLOS PARA MÓDULOS / HIGH STORAGE

MODÈLE / VARIANTES / VERSIONS	TYPE / TIPO / TYPE	DIMENSIONS / MEDIDAS / MEASUREMENTS	RÉFÉRENCE / REFERENCIA / CODE	
	Individuel / Individual / Single face	176,4 x 34,8 cm	Support ouvert / Soporte abierto / L-Shape supports	Support fermé / Soporte cerrado / U-Shape support
			362.020 - - -	362.021 - - -
	Double / Doble / Two faces	176,4 x 67 cm	362.022 - - -	362.023 - - -

Meubles de rangement supérieurs
Altillos para módulos
High storage

FINITIONS | ACABADOS | FINISHES

STRUCTURE / ESTRUCTURA / FRAME | PORTES COULISSANTES / PUERTAS CORREDERAS / SLIDING DOORS

	075 Blanc Blanco White		054 Gris Gris Grey		055 Hêtre Haya Beech		061 Chêne Moyen Roble Maple		062 Poirier Peral Pear
	116 Wengué Wengue Wengue		694 Acacia Clair Acacia Clara Light Acacia		695 Acacia Foncé Acacia Oscura Dark Acacia		696 Zebrano Zebrano Zebrano		125 Graphite Grafito Graphite
	088 Argent Plata Silver		076 Gris Gris Grey		077 Hêtre Haya Beech		078 Chêne Moyen Roble Maple		079 Poirier Peral Pear
	080 Wengué Wengue Wengue		168 Acacia Clair Acacia Clara Light Acacia		169 Acacia Foncé Acacia Oscura Dark Acacia		170 Zebrano Zebrano Zebrano		115 Graphite Grafito Graphite
	228 Argent Plata Silver		229 Blanc Blanco White		230 Gris Gris Grey		231 Hêtre Haya Beech		232 Chêne Moyen Roble Maple
	234 Poirier Peral Pear		700 Acacia Clair Acacia Clara Light Acacia		701 Acacia Foncé Acacia Oscura Dark Acacia		702 Zebrano Zebrano Zebrano		
	051 Argent Plata Silver		053 Blanc Blanco White		197 Gris Gris Grey		198 Hêtre Haya Beech		199 Chêne Moyen Roble Maple
	200 Poirier Peral Pear		202 Wengué Wengue Wengue		103 Acacia Clair Acacia Clara Light Acacia		104 Acacia Foncé Acacia Oscura Dark Acacia		105 Zebrano Zebrano Zebrano
	204 Graphite Grafito Graphite								

| COMPLÉMENTS | COMPLEMENTOS | COMPLEMENTS























MODÈLE / VARIANTES / VERSIONS	DIMENSIONS / MEDIDAS / MEASUREMENTS	RÉFÉRENCE / REFERENCIA / CODE								
 <p>Voiles de fond Faldones Modesty panels</p>	Pour bureaux / para mesas / for desks:	Mélamine / Melamina / Melamine 180 cm 1.351.708... 160 cm 1.351.710... 140 cm 1.351.712...								
	Pour bureaux / para mesas / for desks:	Métal / Metal / Metal 180 cm 1.351.723... 160 cm 1.351.724... 140 cm 1.351.725...								
FINITIONS ACABADOS FINISHES		<table border="0"> <tr> <td>Mélamine Melamina Melamine</td> <td>051 Argent Plata Silver</td> <td>053 Blanc Blanco White</td> <td>007 Graphite Grafito Graphite</td> </tr> <tr> <td>Métal Metal Metal</td> <td>111 Argent Plata Silver</td> <td>108 Blanc Blanco White</td> <td>107 Graphite Grafito Graphite</td> </tr> </table>	Mélamine Melamina Melamine	051 Argent Plata Silver	053 Blanc Blanco White	007 Graphite Grafito Graphite	Métal Metal Metal	111 Argent Plata Silver	108 Blanc Blanco White	107 Graphite Grafito Graphite
Mélamine Melamina Melamine	051 Argent Plata Silver	053 Blanc Blanco White	007 Graphite Grafito Graphite							
Métal Metal Metal	111 Argent Plata Silver	108 Blanc Blanco White	107 Graphite Grafito Graphite							

 <p>Goulotte Bandeja electrificación Cable tray</p>	Pour bureaux / para mesas / for desks:	Indiv. 180 cm 1.356.303... 160 cm 1.356.304... 140 cm 1.356.305...			
	Pour tables de réunion et vis à vis / para mesas de reunión y enfrentadas / for meeting tables and face to face desks	Double / Doble / Double 180 cm 1.356.313... 160 cm 1.356.314... 140 cm 1.356.315...			
FINITIONS ACABADOS FINISHES		<table border="0"> <tr> <td>111 Argent Plata Silver</td> <td>108 Blanc Blanco White</td> <td>107 Graphite Grafito Graphite</td> </tr> </table>	111 Argent Plata Silver	108 Blanc Blanco White	107 Graphite Grafito Graphite
111 Argent Plata Silver	108 Blanc Blanco White	107 Graphite Grafito Graphite			

| CLOISONNETTES FRONTALES | PLAFONES | FRONT SCREENS

1 NIVEAU / 1 NIVEL / 1 LEVEL

2 NIVEAUX / 2 NIVELES / 2 LEVELS

MODÈLE / VARIANTES / VERSIONS	L.	RÉFÉRENCE / REFERENCIA / CODE	MODÈLE / VARIANTES / VERSIONS	L.	RÉFÉRENCE / REFERENCIA / CODE																										
 <p>Mélamine Melamina Melamine</p>	Indiv.	<table border="0"> <tr> <td></td> <td></td> <td></td> </tr> <tr> <td>RAL 9006</td> <td>RAL 9016</td> <td>RAL 7022</td> </tr> </table>				RAL 9006	RAL 9016	RAL 7022	 <p>Mélamine Melamina Melamine</p>	Indiv.	<table border="0"> <tr> <td></td> <td></td> <td></td> </tr> <tr> <td>RAL 9006</td> <td>RAL 9016</td> <td>RAL 7022</td> </tr> </table>				RAL 9006	RAL 9016	RAL 7022														
																															
RAL 9006	RAL 9016	RAL 7022																													
																															
RAL 9006	RAL 9016	RAL 7022																													
180 cm 356.054... 356.154... 356.254... 160 cm 356.055... 356.155... 356.255... 140 cm 356.056... 356.156... 356.256...	Vis à vis / Enfrentadas / Face to face	180 cm 356.057... 356.157... 356.257... 160 cm 356.058... 356.158... 356.258... 140 cm 356.059... 356.159... 356.259...	180 cm 356.064... 356.164... 356.264... 160 cm 356.065... 356.165... 356.265... 140 cm 356.066... 356.166... 356.266...																												
 <p>Mélamine avec rail Melamina con guía Melamine with guide</p>	Indiv.	180 cm 356.037... 356.137... 356.237... 160 cm 356.039... 356.139... 356.239... 140 cm 356.041... 356.141... 356.241...	 <p>Mélamine avec rail Melamina con guía Melamine with guide</p>	Indiv.	180 cm 356.028... 356.128... 356.228... 160 cm 356.030... 356.130... 356.230... 140 cm 356.032... 356.132... 356.232...																										
	180 cm 356.046... 356.146... 356.246... 160 cm 356.048... 356.148... 356.248... 140 cm 356.050... 356.150... 356.250...	Vis à vis / Enfrentadas / Face to face		180 cm 356.047... 356.147... 356.247... 160 cm 356.049... 356.149... 356.249... 140 cm 356.051... 356.151... 356.251...	180 cm 356.075... 356.175... 356.275... 160 cm 356.077... 356.177... 356.277... 140 cm 356.079... 356.179... 356.279...																										
FINITIONS ACABADOS FINISHES		<table border="0"> <tr> <td>007 Graphite Grafito Graphite</td> <td>051 Argent Plata Silver</td> </tr> <tr> <td>053 Blanc Blanco White</td> <td>054 Gris Gris Grey</td> </tr> <tr> <td>061 Chêne Moyen Roble Maple</td> <td>062 Poirier Peral Pear</td> </tr> <tr> <td>103 Acacia Clair Acacia Clara Light Acacia</td> <td>104 Acacia Foncé Acacia Oscura Dark Acacia</td> </tr> </table>	007 Graphite Grafito Graphite	051 Argent Plata Silver	053 Blanc Blanco White	054 Gris Gris Grey	061 Chêne Moyen Roble Maple	062 Poirier Peral Pear	103 Acacia Clair Acacia Clara Light Acacia	104 Acacia Foncé Acacia Oscura Dark Acacia	<table border="0"> <tr> <td>055 Hêtre Haya Beech</td> <td>116 Wengué Wengue Wengue</td> </tr> <tr> <td>105 Zebrano Zebrano Zebrano</td> <td></td> </tr> </table>	055 Hêtre Haya Beech	116 Wengué Wengue Wengue	105 Zebrano Zebrano Zebrano		FINITIONS ACABADOS FINISHES		<table border="0"> <tr> <td>204 Graphite Grafito Graphite</td> <td>088 Argent Plata Silver</td> </tr> <tr> <td>081 Blanc Blanco White</td> <td>197 Gris Gris Grey</td> </tr> <tr> <td>199 Chêne Moyen Roble Maple</td> <td>200 Poirier Peral Pear</td> </tr> <tr> <td>103 Acacia Clair Acacia Clara Light Acacia</td> <td>104 Acacia Foncé Acacia Oscura Dark Acacia</td> </tr> </table>	204 Graphite Grafito Graphite	088 Argent Plata Silver	081 Blanc Blanco White	197 Gris Gris Grey	199 Chêne Moyen Roble Maple	200 Poirier Peral Pear	103 Acacia Clair Acacia Clara Light Acacia	104 Acacia Foncé Acacia Oscura Dark Acacia	<table border="0"> <tr> <td>198 Hêtre Haya Beech</td> <td>202 Wengué Wengue Wengue</td> </tr> <tr> <td>105 Zebrano Zebrano Zebrano</td> <td></td> </tr> </table>	198 Hêtre Haya Beech	202 Wengué Wengue Wengue	105 Zebrano Zebrano Zebrano	
007 Graphite Grafito Graphite	051 Argent Plata Silver																														
053 Blanc Blanco White	054 Gris Gris Grey																														
061 Chêne Moyen Roble Maple	062 Poirier Peral Pear																														
103 Acacia Clair Acacia Clara Light Acacia	104 Acacia Foncé Acacia Oscura Dark Acacia																														
055 Hêtre Haya Beech	116 Wengué Wengue Wengue																														
105 Zebrano Zebrano Zebrano																															
204 Graphite Grafito Graphite	088 Argent Plata Silver																														
081 Blanc Blanco White	197 Gris Gris Grey																														
199 Chêne Moyen Roble Maple	200 Poirier Peral Pear																														
103 Acacia Clair Acacia Clara Light Acacia	104 Acacia Foncé Acacia Oscura Dark Acacia																														
198 Hêtre Haya Beech	202 Wengué Wengue Wengue																														
105 Zebrano Zebrano Zebrano																															

 <p>Portique Pórtico Silver toolbar</p>	180 cm 356.701.111
	160 cm 356.703.111
	140 cm 356.705.111

CLOISONNETTES FRONTALES | PLAFONES | FRONT SCREENS

1 NIVEAU / 1 NIVEL / 1 LEVEL

2 NIVEAUX / 2 NIVELES / 2 LEVELS

MODÈLE / VARIANTES / VERSIONS	L.	RÉFÉRENCE / REFERENCIA / CODE			MODÈLE / VARIANTES / VERSIONS	L.	RÉFÉRENCE / REFERENCIA / CODE		
		RAL 9006	RAL 9016	RAL 7022			RAL 9006	RAL 9016	RAL 7022
	Indiv.					Indiv.			
	180 cm	356.054.000	356.154.000	356.254.000		180 cm	356.064.000	356.164.000	356.264.000
	160 cm	356.055.000	356.155.000	356.255.000		160 cm	356.065.000	356.165.000	356.265.000
	140 cm	356.056.000	356.156.000	356.256.000		140 cm	356.066.000	356.166.000	356.266.000
	Vis à vis / Enfrentadas / Face to face					Vis à vis / Enfrentadas / Face to face			
	180 cm	356.057.000	356.157.000	356.257.000		180 cm	356.067.000	356.167.000	356.267.000
	160 cm	356.058.000	356.158.000	356.258.000		160 cm	356.068.000	356.168.000	356.268.000
	140 cm	356.059.000	356.159.000	356.259.000		140 cm	356.069.000	356.169.000	356.269.000
	Indiv.					Indiv.			
	180 cm	356.081.838	356.181.838	356.281.838		180 cm	356.028.000	596.128.000	596.228.000
	160 cm	356.083.838	356.183.838	356.283.838		160 cm	356.030.000	596.130.000	596.230.000
	140 cm	356.085.838	356.185.838	356.285.838		140 cm	356.032.000	596.132.000	596.232.000
	Vis à vis / Enfrentadas / Face to face					Vis à vis / Enfrentadas / Face to face			
	180 cm	356.091.838	356.191.838	356.291.838		180 cm	356.075.000	356.175.000	356.275.000
	160 cm	356.093.838	356.193.838	356.293.838		160 cm	356.077.000	356.177.000	356.277.000
	140 cm	356.095.838	356.195.838	356.295.838		140 cm	356.079.000	356.179.000	356.279.000

Tissu Tapizado Upholstered

Acoustique Acústico Acoustic

FINITIONS ACABADOS FINISHES Cf. page 574 Ver pagina 574 See page 574

	Indiv.					Indiv.			
	180 cm	356.054.---	356.154.---	356.254.---		180 cm	356.064.---	356.164.---	356.264.---
	160 cm	356.055.---	356.155.---	356.255.---		160 cm	356.065.---	356.165.---	356.265.---
	140 cm	356.056.---	356.156.---	356.256.---		140 cm	356.066.---	356.166.---	356.266.---
	Vis à vis / Enfrentadas / Face to face					Vis à vis / Enfrentadas / Face to face			
	180 cm	356.057.---	356.157.---	356.257.---		180 cm	356.067.---	356.167.---	356.267.---
	160 cm	356.058.---	356.158.---	356.258.---		160 cm	356.068.---	356.168.---	356.268.---
	140 cm	356.059.---	356.159.---	356.259.---		140 cm	356.069.---	356.169.---	356.269.---
	Indiv.					Indiv.			
	180 cm	356.028.---	356.128.---	356.228.---		180 cm	356.028.---	356.128.---	356.228.---
	160 cm	356.030.---	356.130.---	356.230.---		160 cm	356.030.---	356.130.---	356.230.---
	140 cm	356.032.---	356.132.---	356.232.---		140 cm	356.032.---	356.132.---	356.232.---
	Vis à vis / Enfrentadas / Face to face					Vis à vis / Enfrentadas / Face to face			
	180 cm	356.075.---	356.175.---	356.275.---		180 cm	356.075.---	356.175.---	356.275.---
	160 cm	356.077.---	356.177.---	356.277.---		160 cm	356.077.---	356.177.---	356.277.---
	140 cm	356.079.---	356.179.---	356.279.---		140 cm	356.079.---	356.179.---	356.279.---

Méthacrylate Metacrilato Methacrylate

Avec méthacrylate et tapissée Con metacrilato y tapizado With methacrylate and upholstered

Méthacrylate et tapissée avec rail Metacrilato y tapizado con guía Methacrylate and upholstered with guide

FINITIONS ACABADOS FINISHES 411 Transparent Translúcido Clear 412 Blanc opaque Translúcido Translucent 406 Transparent Transparente Clear 427 Blanc opaque Translúcido Translucent



tempo

Polyvalence et lignes épurées sont les principales caractéristiques de cette série. Elle nous permet de créer des espaces de travail avec une apparence légère et simple.

Versatilidad y simplicidad de formas son las características principales de esta serie. Se consiguen espacios diversos con formas ligeras y simples.

Versatility and simplicity on shapes are the main features of this range. Create different working spaces with light and simple looking.

BUREAU
INDIVIDUEL

MESA
INDIVIDUAL

INDIVIDUAL
DESK

PLATEAUX / SOBRE / DESK TOP

Mélamine / Melamina / Melamine: 25 mm
Chant en ABS / Canto ABS / ABS edges

STRUCTURE / ESTRUCTURA / FRAME

Acier: 55 mm x 55 mm x 1,5 mm
Steel: 

FINITION STRUCTURE / ACABADO ESTRUCTURA / FRAME FINISH

Peinture époxy
Pintura epoxi
Epoxy paint

HAUTEUR / ALTURA / HEIGHT

Fixe: 73 mm Réglable: 80,6 > 61,2 mm
Fija: 73 mm Regulable: 80,6 > 61,2 mm
Fixed: Adjustable:

OPTION / OPCIÓN / OPTION

Voile de fond / Faldón / Modesty panel

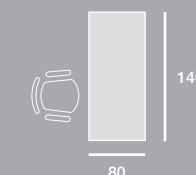



BUREAUX
EN VIS À VIS
AVEC CRÉDENCE

MESAS
ENFRENTADAS
CON CREDENCIA

FACE TO FACE
DESKS WITH
SIDE CREDENZA

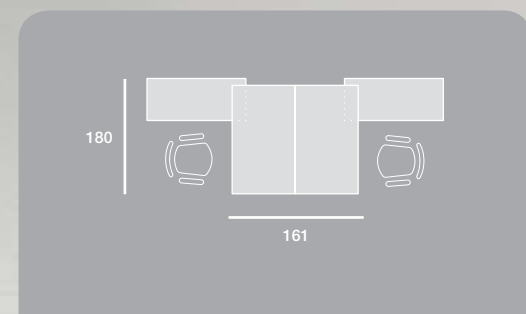

BUREAUX EN
VIS À VIS
AVEC RETOUR

MESAS
ENFRENTADAS
CON ALA

FACE TO
FACE DESKS
WITH RETURN

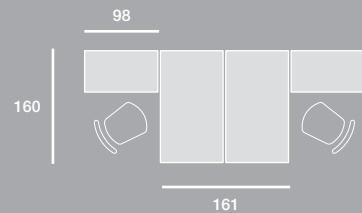

BUREAUX
EN VIS À VIS

MESAS
ENFRENTADAS

FACE TO
FACE DESKS

Combinable avec caissons et crédences OH-SYSTEMS.
Combinable con cajoneras y credencias OH-SYSTEMS.
Combine with OH-SYSTEMS pedestals and credenzas.

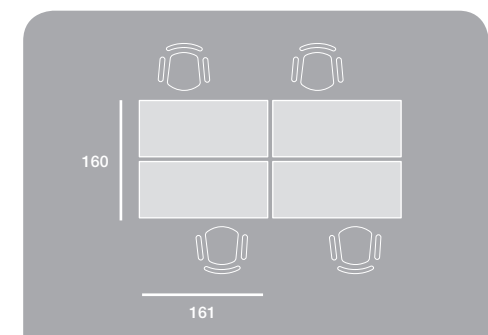



Structure fixe ou réglable en hauteur.
La estructura puede ser fija o regulable en altura.
Fixed or adjustable height frame.



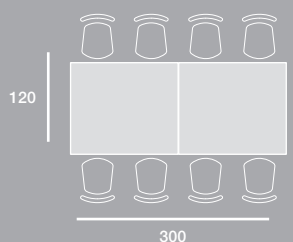

| TABLES DE
| RÉUNION

| MESAS DE
| REUNIÓN





| MEETING
| TABLES

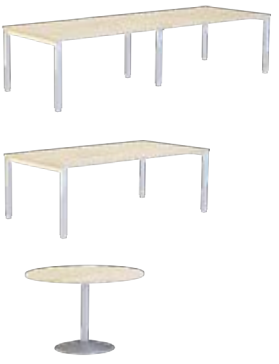

MODÈLES | VARIANTES | VERSIONS

MODÈLE / VARIANTES / VERSIONS	TYPE / TIPO / TYPE	DIMENSIONS / MEDIDAS / MEASUREMENTS	RÉFÉRENCE / REFERENCIA / CODE	
	Bureau individuel Mesa individual Individual desks	180 x 80 cm	381.301.---	381.401.---
		160 x 80 cm	381.302.---	381.402.---
		140 x 80 cm	381.303.---	381.403.---
		120 x 80 cm	381.304.---	381.404.---
		80 x 80 cm	381.305.---	381.405.---
		180 x 60 cm	381.501.---	381.601.---
		160 x 60 cm	381.502.---	381.602.---
		140 x 60 cm	381.503.---	381.603.---
		120 x 60 cm	381.504.---	381.604.---
		80 x 60 cm	381.505.---	381.605.---
			H. fixe / fija / fixed	H. réglable / regulable / adjustable
	Bureau individuel pour crédence Mesa individual con credencia Individual desks with side credenza	180 x 80 cm	381.381.---	381.382.---
		160 x 80 cm	381.383.---	381.384.---
		140 x 80 cm	381.385.---	381.386.---
		180 x 60 cm	381.575.---	381.576.---
		160 x 60 cm	381.577.---	381.578.---
		140 x 60 cm	381.579.---	381.580.---
			À droite / Derecha / Right	À gauche / Izquierda / Left
	Bureaux alignés Mesas lineales Side by side desks	360 x 80 cm	381.318.---	381.418.---
		320 x 80 cm	381.319.---	381.419.---
		280 x 80 cm	381.320.---	381.420.---
		240 x 80 cm	381.321.---	381.421.---
		360 x 60 cm	381.518.---	381.618.---
		320 x 60 cm	381.519.---	381.619.---
		280 x 60 cm	381.520.---	381.620.---
		240 x 60 cm	381.521.---	381.621.---
	Bureaux en vis à vis Mesas enfrentadas Face to face desks	360 x 161 cm	381.362.---	381.462.---
		320 x 161 cm	381.363.---	381.463.---
		280 x 161 cm	381.364.---	381.464.---
		240 x 161 cm	381.365.---	381.465.---
		180 x 161 cm	381.366.---	381.466.---
		160 x 161 cm	381.367.---	381.467.---
		140 x 161 cm	381.368.---	381.468.---
		120 x 161 cm	381.369.---	381.469.---
			H. fixe / fija / fixed	H. réglable / regulable / adjustable
	Bureaux en vis à vis pour crédence Mesas enfrentadas con credencia Face to face desks with side credenza	360 x 161 cm	381.388.---	
		320 x 161 cm	381.389.---	
		280 x 161 cm	381.390.---	
		180 x 161 cm	381.391.---	
		160 x 161 cm	381.392.---	
		140 x 161 cm	381.393.---	
			H. fixe / fija / fixed	H. réglable / regulable / adjustable
	Tables de réunion Mesas de reunión Meeting tables	450 x 120 cm	384.050.---	384.150.---
		300 x 120 cm	384.055.---	384.155.---
		250 x 120 cm	384.021.---	384.121.---
		200 x 120 cm	384.022.---	384.122.---
		120 x 120 cm	384.026.---	384.126.---
		Ø 116 cm	404.132.---	

COMPLÉMENTS | COMPLEMENTOS | COMPLEMENTS

MODÈLE / VARIANTES / VERSIONS	DIMENSIONS / MEDIDAS / MEASUREMENTS	RÉFÉRENCE / REFERENCIA / CODE	
	98 x 60 cm	H. fixe / fija / fixed	H. réglable / regulable / adjustable
Retour secrétaire Ala taquígrafa Return		381.328.---	381.428.---
	158 x 118 cm	H. fixe / fija / fixed	H. réglable / regulable / adjustable
Exécutif Ejecutivo Teardrop		381.330.---	381.430.---
	161 x 70 cm	H. fixe / fija / fixed	H. réglable / regulable / adjustable
Demi-rond Semicircular Semicircular		381.331.---	381.431.---
	161 x 40 cm	H. fixe / fija / fixed	H. réglable / regulable / adjustable
Semi-elliptique Semiélliptico Semielliptic		381.332.---	381.432.---
	123 X 78,3 cm	H. fixe / fija / fixed	
Angle concave 90° Ángulo cóncavo 90° 90° Concave angle		1.381.033.---	

FINITIONS ACABADOS FINISHES

053 Blanc Blanco White	054 Gris Gris Grey	055 Hêtre Haya Beech
061 Chêne Moyen Roble Maple	062 Poirier Peral Pear	116 Wengué Wengue
103 Acacia Clair Acacia Clara Light Acacia	104 Acacia Foncé Acacia Oscura Dark Acacia	105 Zebrano Zebrano

FINITIONS | ACABADOS | FINISHES

STRUCTURE / ESTRUCTURA / FRAME | PLATEAUX / SOBRE / DESK TOP

	060 Blanc Blanco White	064 Gris Gris Grey	065 Hêtre Haya Beech	066 Chêne Moyen Roble Maple	067 Poirier Peral Pear
	068 Wengué Wengue	706 Acacia Clair Acacia Clara Light Acacia	707 Acacia Foncé Acacia Oscura Dark Acacia	708 Zebrano Zebrano	
	096 Blanc Blanco White	097 Gris Gris Grey	098 Hêtre Haya Beech	099 Chêne Moyen Roble Maple	100 Poirier Peral Pear
	101 Wengué Wengue	709 Acacia Clair Acacia Clara Light Acacia	710 Acacia Foncé Acacia Oscura Dark Acacia	711 Zebrano Zebrano	

| COMPLÉMENTS | COMPLEMENTOS | COMPLEMENTS

MODÈLE / VARIANTES / VERSIONS	DIMENSIONS / MEDIDAS / MEASUREMENTS	RÉFÉRENCE / REFERENCIA / CODE
-------------------------------	-------------------------------------	-------------------------------

		Mélamine / Melamina / Melamine	
	Pour bureaux / para mesas / for desks:	180 cm	441.602.---
		160 cm	441.603.---
		140 cm	441.604.---
		120 cm	441.605.---
		Angle 90° / Ángulo 90° / 90° angle 80 cm	441.618.---
		441.606.---	
		Métal / Metal / Metal	
Voiles de fond Faldones Modesty panels	Pour bureaux / para mesas / for desks:	180 cm	441.702.---
		160 cm	441.703.---
		140 cm	441.704.---
		120 cm	441.705.---
		Angle 90° / Ángulo 90° / 90° angle 80 cm	441.706.---

FINITIONS ACABADOS FINISHES

Mélamine Melamina Melamine	051 Argent Plata Silver	053 Blanc Blanco White
Métal Metal Metal	111 Argent Plata Silver	108 Blanc Blanco White

		Indiv.	
	Pour bureaux / para mesas / for desks:	220 cm	1.386.300.---
		200 cm	1.386.301.---
		180 cm	1.386.302.---
		160 cm	1.386.303.---
		140 cm	1.386.304.---
		120 cm	1.386.305.---
		80 cm	1.386.307.---

		Double / Doble / Double	
	Pour tables de réunion et vis à vis / para mesas de reunión y enfrentadas / for meeting tables and face to face desks	250 cm	1.386.310.---
		200 cm	1.386.311.---
		180 cm	1.386.312.---
		150 / 160 cm	1.386.313.---
		140 cm	1.386.314.---
120 cm	1.386.315.---		
80 cm	1.386.317.---		

FINITIONS ACABADOS FINISHES

111 Argent Plata Silver	108 Blanc Blanco White
--------------------------------------	-------------------------------------

Goulotte
Bandeja electrificación
Cable tray

| CLOISONNETTES FRONTALES | PLAFONES | FRONT SCREENS

1 NIVEAU / 1 NIVEL / 1 LEVEL

2 NIVEAUX / 2 NIVELES / 2 LEVELS

MODÈLE / VARIANTES / VERSIONS	L.	RÉFÉRENCE / REFERENCIA / CODE	MODÈLE / VARIANTES / VERSIONS	L.	RÉFÉRENCE / REFERENCIA / CODE
-------------------------------	----	-------------------------------	-------------------------------	----	-------------------------------

		PINCES / PINZAS / BRACKET	
	Indiv. Vis à vis / Enfrentadas / Face to face	180 cm	386.008.---
		160 cm	386.009.---
		140 cm	386.010.---
		120 cm	386.011.---
		80 cm	386.013.---

Mélamine
Melamina
Melamine

		PINCES / PINZAS / BRACKET	
	Indiv. Vis à vis / Enfrentadas / Face to face	180 cm	386.021.---
		160 cm	386.022.---
		140 cm	386.023.---
		120 cm	386.024.---
		80 cm	386.026.---

Mélamine
Melamina
Melamine

FINITIONS ACABADOS FINISHES

007 Graphite Grafito Graphite	051 Argent Plata Silver
053 Blanc Blanco White	054 Gris Gris Grey
061 Chêne Moyen Roble Maple	062 Poirier Peral Pear
103 Acacia Clair Acacia Clara Light Acacia	104 Acacia Foncé Acacia Oscura Dark Acacia
055 Hêtre Haya Beech	116 Wengué Wengue Wengue
105 Zebrano Zebrano Zebrano	

FINITIONS ACABADOS FINISHES

204 Graphite Grafito Graphite	088 Argent Plata Silver
081 Blanc Blanco White	197 Gris Gris Grey
199 Chêne Moyen Roble Maple	200 Poirier Peral Pear
103 Acacia Clair Acacia Clara Light Acacia	104 Acacia Foncé Acacia Oscura Dark Acacia
198 Hêtre Haya Beech	202 Wengué Wengue Wengue
105 Zebrano Zebrano Zebrano	

		Indiv. Vis à vis / Enfrentadas / Face to face	
	Indiv. Vis à vis / Enfrentadas / Face to face	180 cm	386.008.000
		160 cm	386.009.000
		140 cm	386.010.000
		120 cm	386.011.000
		80 cm	386.013.000

Tissu
Tapizado
Upholstered

		Indiv. Vis à vis / Enfrentadas / Face to face	
	Indiv. Vis à vis / Enfrentadas / Face to face	180 cm	386.021.000
		160 cm	386.022.000
		140 cm	386.023.000
		120 cm	386.024.000
		80 cm	386.026.000

Tissu
Tapizado
Upholstered

FINITIONS ACABADOS FINISHES

Cf. page 574
Ver pagina 574
See page 574

FINITIONS ACABADOS FINISHES

Cf. page 574
Ver pagina 574
See page 574

		Indiv. Vis à vis / Enfrentadas / Face to face	
	Indiv. Vis à vis / Enfrentadas / Face to face	180 cm	386.008.---
		160 cm	386.009.---
		140 cm	386.010.---
		120 cm	386.011.---
		80 cm	386.013.---

Méthacrylate
Metacrilato
Methacrylate

		Indiv. Vis à vis / Enfrentadas / Face to face	
	Indiv. Vis à vis / Enfrentadas / Face to face	180 cm	386.021.---
		160 cm	386.022.---
		140 cm	386.023.---
		120 cm	386.024.---
		80 cm	386.026.---

Avec méthacrylate et tapissée
Con metacrilato y tapizado
With methacrylate and upholstered

FINITIONS ACABADOS FINISHES

411 Transparent Transparente Clear	412 Blanc opaque Translúcido Transparent
---	---

FINITIONS ACABADOS FINISHES

406 Transparent Transparente Clear	427 Blanc opaque Translúcido Transparent
---	---

ECO

ECO, une série modulaire et polyvalente résolument adaptée aux besoins du marché.

Culminación de esfuerzos encaminados a satisfacer las necesidades de trabajo más exigentes.

This range is the result of many efforts seeking to meet the most demanding working needs from the simplicity of shapes and design.

PLATEAUX / SOBRE / DESK TOP

Mélamine / Melamina / Melamine:
Stratifié / Estratificado / Stratified: 25 mm

Chant en ABS / Canto ABS / ABS edges

STRUCTURE / ESTRUCTURA / FRAME

Acier
Acero 60 x 60 x 2 mm
Steel



FINITION STRUCTURE / ACABADO ESTRUCTURA / FRAME FINISH

Peinture époxy
Pintura epoxi
Epoxy paint

HAUTEUR / ALTURA / HEIGHT

73 mm

OPTION / OPCIÓN / OPTION

Voile de fond / Faldón / Modesty panel



BUREAU
INDIVIDUEL
AVEC CRÉDENCE

MESA
INDIVIDUAL
CON CREDENCIA

INDIVIDUAL
DESK WITH
SIDE CREDENZA

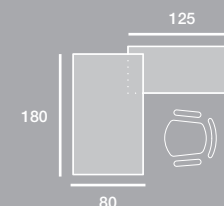

BUREAUX
INDIVIDUELS

MESAS
INDIVIDUALES

INDIVIDUAL
DESKS

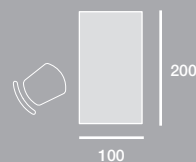

BUREAUX EN
VIS À VIS

MESAS
ENFRENTADAS

FACE TO FACE
DESKS

Combinable avec caissons et crédences OH-SYSTEMS.
Combinable con cajoneras y credencias OH-SYSTEMS.
Combine with OH-SYSTEMS pedestals and credenzas.

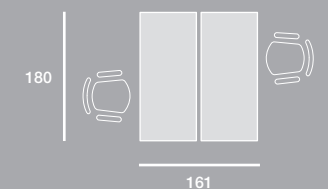

BUREAUX EN
VIS À VIS
AVEC RETOUR

MESAS
ENFRENTADAS
CON ALA

FACE TO FACE
DESKS WITH
RETURN

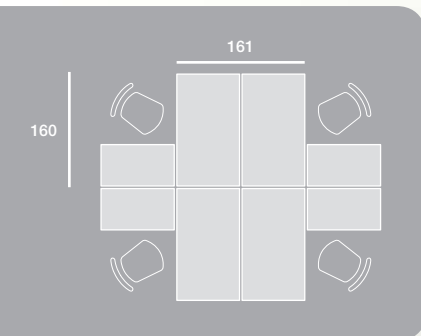



| TABLES DE
| RÉUNION

| MESAS DE
| REUNIÓN

| MEETING
| TABLES



Ancrage rapide
Anclaje rápido
Fastening without tools

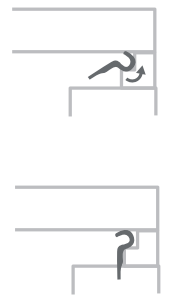



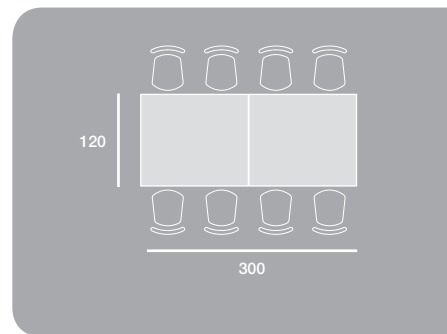

Goulotte
Canal de electrificación
Cable tray



MODÈLES | VARIANTES | VERSIONS

MODÈLE / VARIANTES / VERSIONS	TYPE / TIPO / TYPE	DIMENSIONS / MEDIDAS / MEASUREMENTS	RÉFÉRENCE / REFERENCIA / CODE	
 <p>Bureau individuel Mesa individual Individual desks</p>		220 x 100 cm 200 x 100 cm	391.931.-.- 391.932.-.-	
		180 x 80 cm 160 x 80 cm 140 x 80 cm 120 x 80 cm 80 x 80 cm	391.901.-.- 391.902.-.- 391.903.-.- 391.904.-.- 391.905.-.-	
 <p>Bureau individuel pour crédence Mesa individual con credencia Individual desks with side credenza</p>			À droite / Derecha / Right	À gauche / Izquierda / Left
		180 x 80 cm 160 x 80 cm 140 x 80 cm	391.906.-.- 391.908.-.- 391.910.-.-	391.907.-.- 391.909.-.- 391.911.-.-
 <p>Bureaux en vis à vis Mesas enfrentadas Face to face desks</p>	4 bureaux / mesas / desktops	360 x 161 cm 320 x 161 cm 280 x 161 cm 200 x 161 cm	391.962.-.- 391.963.-.- 391.964.-.- 391.965.-.-	
	2 bureaux / mesas / desktops	180 x 161 cm 160 x 161 cm 140 x 161 cm 100 x 161 cm	391.966.-.- 391.967.-.- 391.968.-.- 391.969.-.-	
 <p>Bureaux en vis à vis pour crédence Mesas enfrentadas para credencia Face to face desks with side credenza</p>	4 bureaux / mesas / desktops	360 x 161 cm 320 x 161 cm 280 x 161 cm	391.934.-.- 391.935.-.- 391.936.-.-	
	2 bureaux / mesas / desktops	180 x 161 cm 160 x 161 cm 140 x 161 cm	391.937.-.- 391.938.-.- 391.939.-.-	
		450 x 120 cm 300 x 120 cm	394.050.-.- 394.055.-.-	
		250 x 120 cm 200 x 120 cm 120 x 120 cm	394.021.-.- 394.022.-.- 394.026.-.-	
 <p>Tables de réunion Mesas de reunión Meeting tables</p>		Ø 116 cm	404.132.-.-	

COMPLÉMENTS | COMPLEMENTOS | COMPLEMENTS

MODÈLE / VARIANTES / VERSIONS	DIMENSIONS / MEDIDAS / MEASUREMENTS	RÉFÉRENCE / REFERENCIA / CODE
 <p>Retour secrétaire Ala taquígrafa Return</p>	98 x 60 cm	Droite / Derecha / Right: 391.915.-.- Gauche / Izquierda / Left: 391.916.-.-
 <p>Exécutif Ejecutivo Teardrop</p>	158 x 118 cm	391.925.-.-
 <p>Demi-rond Semicircular Semicircular</p>	161 x 70 cm	391.019.-.-
 <p>Semi-elliptique Semiéllíptico Semielliptic</p>	161 x 40 cm	391.022.-.-
 <p>Angle concave 90° Ángulo cóncavo 90° 90° Concave angle</p>	123 X 78,3 cm	441.017.-.-

FINITIONS ACABADOS FINISHES

053 Blanc Blanco White	054 Gris Gris Grey	055 Hêtre Haya Beech
061 Chêne Moyen Roble Maple	062 Poirier Peral Pear	063 Wengué Wengue Wengue
103 Acacia Clair Acacia Clara Light Acacia	104 Acacia Foncé Acacia Oscura Dark Acacia	105 Zebrano Zebrano Zebrano

FINITIONS | ACABADOS | FINISHES

STRUCTURE / ESTRUCTURA / FRAME | PLATEAUX / SOBRE / DESK TOP

 <p>Argent Plata Silver RAL 9006</p>	060 Blanc Blanco White	064 Gris Gris Grey	065 Hêtre Haya Beech	066 Chêne Moyen Roble Maple	067 Poirier Peral Pear
	068 Wengué Wengue Wengue	706 Acacia Clair Acacia Clara Light Acacia	707 Acacia Foncé Acacia Oscura Dark Acacia	708 Zebrano Zebrano Zebrano	
 <p>Blanc Blanco White RAL 9016</p>	096 Blanc Blanco White	097 Gris Gris Grey	098 Hêtre Haya Beech	099 Chêne Moyen Roble Maple	100 Poirier Peral Pear
	101 Wengué Wengue Wengue	709 Acacia Clair Acacia Clara Light Acacia	710 Acacia Foncé Acacia Oscura Dark Acacia	711 Zebrano Zebrano Zebrano	

| COMPLÉMENTS | COMPLEMENTOS | COMPLEMENTS

MODÈLE / VARIANTES / VERSIONS	DIMENSIONS / MEDIDAS / MEASUREMENTS	RÉFÉRENCE / REFERENCIA / CODE
	Pour bureaux / para mesas / for desks: 220 cm 200 cm 180 cm 160 cm 140 cm 120 cm Angle 90° / Ángulo 90° / 90° angle 80 cm	Mélamine / Melamina / Melamine 441.600.--- 441.601.--- 441.602.--- 441.603.--- 441.604.--- 441.605.--- 441.618.--- 441.606.---
		Métal / Metal / Metal 441.700.--- 441.701.--- 441.702.--- 441.703.--- 441.704.--- 441.705.--- 441.706.---
<p>FINITIONS ACABADOS FINISHES</p> <p>Mélamine Melamina Melamine</p> <p>051 Argent Plata Silver 053 Blanc Blanco White</p> <p>Métal Metal Metal</p> <p>111 Argent Plata Silver 108 Blanc Blanco White</p>		

	Pour tables de réunion et bureaux en vis à vis / para mesas de reunión y enfrentadas / for meeting tables and face to face desks: 250 cm 200 cm 180 cm 150 / 160 cm 140 cm 120 cm 80 cm	Double / Doble / Double 1.386.310.--- 1.386.311.--- 1.386.312.--- 1.386.313.---
		1.386.314.--- 1.386.315.--- 1.386.317.---
<p>FINITIONS ACABADOS FINISHES</p> <p>111 Argent Plata Silver 108 Blanc Blanco White</p>		

Goulotte
Bandeja electrificación
Cable tray

| CLOISONNETTES FRONTALES | PLAFONES | FRONT SCREENS

1 NIVEAU / 1 NIVEL / 1 LEVEL

MODÈLE / VARIANTES / VERSIONS	L.	RÉFÉRENCE / REFERENCIA / CODE
	Indiv. Vis à vis / Enfrentadas / Face to face	PINCES / PINZAS / BRACKET RAL 9006 RAL 9016
	180 cm	386.008.--- 386.108.---
	160 cm	386.009.--- 386.109.---
	140 cm	386.010.--- 386.110.---
	120 cm	386.011.--- 386.111.---
	80 cm	386.013.--- 386.113.---
<p>Mélamine Melamina Melamine</p>		

FINITIONS ACABADOS FINISHES	007 Graphite Grafito Graphite	051 Argent Plata Silver
053 Blanc Blanco White	054 Gris Gris Grey	055 Hêtre Haya Beech
061 Chêne Moyen Roble Maple	062 Poirier Peral Pear	116 Wengué Wengue Wengue
103 Acacia Clair Acacia Clara Light Acacia	104 Acacia Foncé Acacia Oscura Dark Acacia	105 Zebano Zebrano Zebrano

2 NIVEAUX / 2 NIVELES / 2 LEVELS

MODÈLE / VARIANTES / VERSIONS	L.	RÉFÉRENCE / REFERENCIA / CODE
	Indiv. Vis à vis / Enfrentadas / Face to face	PINCES / PINZAS / BRACKET RAL 9006 RAL 9016
	180 cm	386.021.--- 386.121.---
	160 cm	386.022.--- 386.122.---
	140 cm	386.023.--- 386.123.---
	120 cm	386.024.--- 386.124.---
	80 cm	386.026.--- 386.126.---
<p>Mélamine Melamina Melamine</p>		

FINITIONS ACABADOS FINISHES	204 Graphite Grafito Graphite	088 Argent Plata Silver
081 Blanc Blanco White	197 Gris Gris Grey	198 Hêtre Haya Beech
199 Chêne Moyen Roble Maple	200 Poirier Peral Pear	202 Wengué Wengue Wengue
103 Acacia Clair Acacia Clara Light Acacia	104 Acacia Foncé Acacia Oscura Dark Acacia	105 Zebano Zebrano Zebrano

	Indiv. Vis à vis / Enfrentadas / Face to face	
	180 cm	386.008.000 386.108.000
	160 cm	386.009.000 386.109.000
	140 cm	386.010.000 386.110.000
	120 cm	386.011.000 386.111.000
	80 cm	386.013.000 386.113.000
<p>Tissu Tapizado Upholstered</p>		

FINITIONS ACABADOS FINISHES	Cf. page 574 Ver pagina 574 See page 574
------------------------------------	--

	Indiv. Vis à vis / Enfrentadas / Face to face	
	180 cm	386.021.000 386.121.000
	160 cm	386.022.000 386.122.000
	140 cm	386.023.000 386.123.000
	120 cm	386.024.000 386.124.000
	80 cm	386.026.000 386.126.000
<p>Tissu Tapizado Upholstered</p>		

FINITIONS ACABADOS FINISHES	Cf. page 574 Ver pagina 574 See page 574
------------------------------------	--

	Indiv. Vis à vis / Enfrentadas / Face to face	
	180 cm	386.008.--- 386.108.---
	160 cm	386.009.--- 386.109.---
	140 cm	386.010.--- 386.110.---
	120 cm	386.011.--- 386.111.---
	80 cm	386.013.--- 386.113.---
<p>Méthacrylate Metacrilato Methacrylate</p>		

FINITIONS ACABADOS FINISHES	411 Transparent Transparente Clear	412 Blanc opaque Translúcido Translucent
------------------------------------	------------------------------------	--

	Indiv. Vis à vis / Enfrentadas / Face to face	
	180 cm	386.021.--- 386.121.---
	160 cm	386.022.--- 386.122.---
	140 cm	386.023.--- 386.123.---
	120 cm	386.024.--- 386.124.---
	80 cm	386.026.--- 386.126.---
<p>Avec méthacrylate et tapisée Con metacrilato y tapizado With methacrylate and upholstered</p>		

FINITIONS ACABADOS FINISHES	406 Transparent Transparente Clear	427 Blanc opaque Translúcido Translucent
------------------------------------	------------------------------------	--

ROCK K4

Le piètement de la série ROCK 4 est un élément qui combine robustesse et légèreté. Disponible aussi en structure réglable en hauteur afin de satisfaire les nécessités plus spécifiques.

El lateral ROCK 4 es un elemento ideal que combina robustez y ligereza. Es una gama técnica existente también en versión regulable en altura, para atender a necesidades específicas.

ROCK 4 range is the most strong product line. Different combinations of steel crossbar structures enable to create multiple work stations options.

BUREAU
INDIVIDUEL

MESA
INDIVIDUAL

INDIVIDUAL
DESK



PLATEAUX / SOBRE / DESK TOP

Mélamine / Melamina / Melamine: 25 mm
Verre / Vidrio / Glass: 10 mm

Chant en ABS / Canto ABS / ABS edges

STRUCTURE / ESTRUCTURA / FRAME

Acier
Acero
Steel 60 x 60 x 2 mm

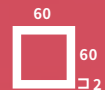

FINITION STRUCTURE / ACABADO ESTRUCTURA / FRAME FINISH

Peinture époxy
Pintura epoxi
Epoxy paint

HAUTEUR / ALTURA / HEIGHT

73 mm

OPTION / OPCIÓN / OPTION

Voile de fond / Faldón / Modesty panel

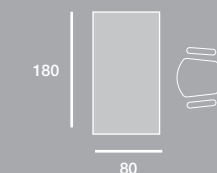

POSTES
COMPACTS
EN VIS À VIS

PUESTOS
COMPACTOS
ENFRENTADOS

FACE TO FACE
L-SHAPE
DESKS



BENCH EN
VIS À VIS

MESAS
ENFRENTADAS

FACE TO FACE
DESKS

Combinable avec caissons et crédences OH-SYSTEMS.
Combinable con cajoneras y credencias OH-SYSTEMS.
Combine with OH-SYSTEMS pedestals and credenzas.

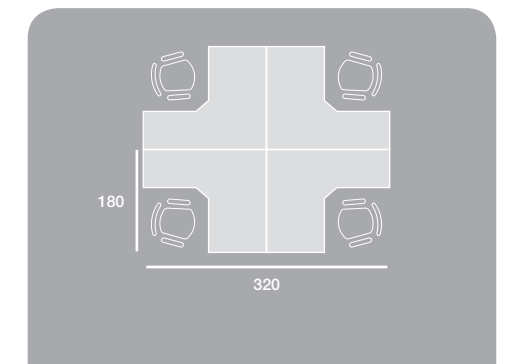
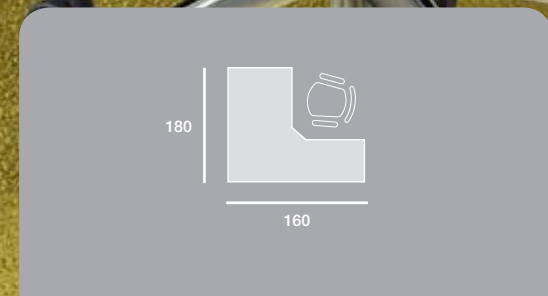

BUREAUX
EN VIS À VIS

MESAS
ENFRENTADAS

FACE TO FACE
DESK





Les plateaux se fixent à la structure sans besoin d'outillage, simplifiant ainsi le montage.
El anclaje rápido permite montar el sobre con la estructura sin necesidad de herramientas.
Tops are fixed to the structure of the desk with fast-fixing system (no tools needed) that makes easier the assembly process.

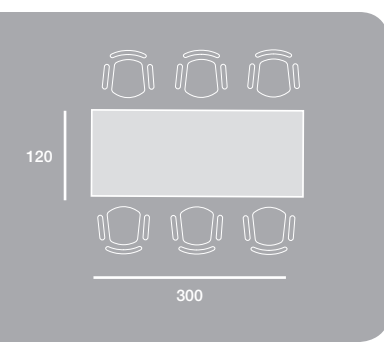
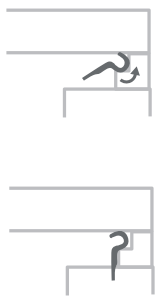







| TABLES DE
| RÉUNION

| MESAS DE
| REUNIÓN

| MEETING
| TABLES



MODÈLES | VARIANTES | VERSIONS



MODÈLE / VARIANTES / VERSIONS	TYPE / TIPO / TYPE	DIMENSIONS / MEDIDAS / MEASUREMENTS	RÉFÉRENCE / REFERENCIA / CODE
	Bureau individuel Mesa individual Individual desks	220 x 100 cm 200 x 100 cm	441.131.-.- * 441.132.-.- *
		180 x 80 cm 160 x 80 cm 140 x 80 cm 120 x 80 cm 80 x 80 cm	441.711.-.- * 441.712.-.- * 441.713.-.- 441.714.-.- 441.716.-.-
	Poste compact VII Compacto VII L-shaped desks VII	180 x 120 cm	441.146.-.- Droit / Derecha / Right 441.147.-.- Gauche / Izquierda / Left
		160 x 120 cm	441.160.-.- Droit / Derecha / Right 441.161.-.- Gauche / Izquierda / Left
	Poste compact VII pour caisson hauteur bureau Compacto VII con cajonera adosada L-shaped desks VII with fixed pedestal	180 x 120 cm	441.162.-.- Droit / Derecha / Right 441.163.-.- Gauche / Izquierda / Left
		160 x 120 cm	441.164.-.- Droit / Derecha / Right 441.165.-.- Gauche / Izquierda / Left
	2 bureaux / mesas / tables Bureaux en vis à vis Mesas enfrentadas Face to face desks	180 x 160 cm 160 x 160 cm 140 x 160 cm 120 x 160 cm 80 x 160 cm	441.727.-.- * 441.728.-.- * 441.729.-.- 441.730.-.- 441.732.-.-
		180 x 120 cm 160 x 120 cm 140 x 120 cm 120 x 120 cm 80 x 120 cm	441.759.-.- 441.760.-.- 441.761.-.- 441.762.-.- * 441.764.-.-
	4 bureaux / mesas / tables 2 bureaux / mesas / tables Postes compacts en vis à vis Compactos enfrentados Face to face L-shaped desks	360 x 240 cm 320 x 240 cm	441.777.-.- 441.778.-.-
		180 x 240 cm 160 x 240 cm	441.774.-.- 441.775.-.-
	4 bureaux / mesas / tables 2 bureaux / mesas / tables Postes compacts en vis à vis pour caisson porteur Compactos VIII enfrentados con cajonera soportante Face to face L-shaped desks with fixed pedestals	360 x 240 cm + 44 cm caisson / cajonera / pedestal 320 x 240 cm + 44 cm caisson / cajonera / pedestal	441.783.-.- 441.784.-.-
		180 x 240 cm + 44 cm caisson / cajonera / pedestal 160 x 240 cm + 44 cm caisson / cajonera / pedestal	441.780.-.- 441.781.-.-

MODÈLE / VARIANTES / VERSIONS	DIMENSIONS / MEDIDAS / MEASUREMENTS	RÉFÉRENCE / REFERENCIA / CODE
	300 x 120 cm	444.125.-.-
	150 x 120 cm	444.124.-.-

Tables de réunion
Mesas de reunión
Meeting tables

FINITIONS | ACABADOS | FINISHES

STRUCTURE / ESTRUCTURA / FRAME | PLATEAUX / SOBRE / DESK TOP

	060 Blanc Blanco White	064 Gris Gris Grey	065 Hêtre Haya Beech	066 Chêne Moyen Roble Maple	067 Poirier Peral Pear
	068 Wengué Wengue Wengue	706 Acacia Clair Acacia Clara Light Acacia	707 Acacia Foncé Acacia Oscura Dark Acacia	708 Zebrano Zebrano Zebrano	
Verre / Vidrio / Glass *					
310 Blanc Blanco White	312 Cuivre Cobre Cooper	311 Noir Negro Black			
	096 Blanc Blanco White	097 Gris Gris Grey	098 Hêtre Haya Beech	099 Chêne Moyen Roble Maple	100 Poirier Peral Pear
	101 Wengué Wengue Wengue	709 Acacia Clair Acacia Clara Light Acacia	710 Acacia Foncé Acacia Oscura Dark Acacia	711 Zebrano Zebrano Zebrano	

| COMPLÉMENTS | COMPLEMENTOS | COMPLEMENTS

MODÈLE / VARIANTES / VERSIONS	DIMENSIONS / MEDIDAS / MEASUREMENTS	RÉFÉRENCE / REFERENCIA / CODE	
 <p>Retour secrétaire Ala taquígrafa Return</p>	98 x 60 cm	Droite / Derecha / Right 441.115.---	Gauche / Izquierda / Left 441.116.---
 <p>Demi-rond Semicircular Semicircular</p>	160 x 70 cm	441.119.---	
 <p>Semi-elliptique Semielliptic Semielliptic</p>	160 x 40 cm	441.122.---	
 <p>Angle concave 90° Ángulo cóncavo 90° 90° Concave angle</p>	80 X 80 cm	441.017.---	

FINITIONS ACABADOS FINISHES

053 Blanc Blanco White	054 Gris Gris Grey	055 Hêtre Haya Beech
061 Chêne Moyen Roble Maple	062 Poirier Peral Pear	063 Wengué Wengue Wengue
103 Acacia Clair Acacia Clara Light Acacia	104 Acacia Foncé Acacia Oscura Dark Acacia	105 Zebrano Zebrano Zebrano

| FINITIONS | ACABADOS | FINISHES

STRUCTURE / ESTRUCTURA / FRAME | PLATEAUX / SOBRE / DESK TOP

060 Blanc Blanco White	064 Gris Gris Grey	065 Hêtre Haya Beech	066 Chêne Moyen Roble Maple	067 Poirier Peral Pear	068 Wengué Wengue Wengue	706 Acacia Clair Acacia Clara Light Acacia	707 Acacia Foncé Acacia Oscura Dark Acacia	708 Zebrano Zebrano Zebrano
096 Blanc Blanco White	097 Gris Gris Grey	098 Hêtre Haya Beech	099 Chêne Moyen Roble Maple	100 Poirier Peral Pear	101 Wengué Wengue Wengue	709 Acacia Clair Acacia Clara Light Acacia	710 Acacia Foncé Acacia Oscura Dark Acacia	711 Zebrano Zebrano Zebrano

| COMPLÉMENTS | COMPLEMENTOS | COMPLEMENTS

MODÈLE / VARIANTES / VERSIONS	DIMENSIONS / MEDIDAS / MEASUREMENTS	RÉFÉRENCE / REFERENCIA / CODE	
 <p>Voiles de fond Faldones Modesty panels</p>	Pour bureaux / para mesas / for desks: 220 cm 200 cm 180 cm 160 cm 140 cm Angle 90° / Ángulo 90° / 90° angle 120 cm 80 cm	Mélamine / Melamina / Melamine 441.600.--- 441.601.--- 441.602.--- 441.603.--- 441.604.--- 441.605.--- 441.618.--- 441.606.---	
	Pour bureaux / para mesas / for desks: 220 cm 200 cm 180 cm 160 cm 140 cm 80 cm	Métal / Metal / Metal 441.700.--- 441.701.--- 441.702.--- 441.703.--- 441.704.--- 441.705.--- 441.706.---	

FINITIONS ACABADOS FINISHES

Mélamine Melamina Melamine	051 Argent Plata Silver	053 Blanc Blanco White
Métal Metal Metal	111 Argent Plata Silver	108 Blanc Blanco White

| CLOISONNETTES FRONTALES | PLAFONES | FRONT SCREENS

1 NIVEAU / 1 NIVEL / 1 LEVEL

MODÈLE / VARIANTES / VERSIONS	L.	RÉFÉRENCE / REFERENCIA / CODE	MODÈLE / VARIANTES / VERSIONS	L.	RÉFÉRENCE / REFERENCIA / CODE
 <p>Mélamine Melamina Melamine</p>	Indiv. 180 cm 160 cm 140 cm 120 cm 80 cm	406.004.--- 406.006.--- 406.008.--- 406.010.--- 406.014.---	 <p>Mélamine avec rail Melamina con guía Melamine with guide</p>	Indiv. 180 cm 160 cm 140 cm 120 cm 80 cm	406.034.--- 406.036.--- 406.038.--- 406.040.--- 406.044.---

FINITIONS ACABADOS FINISHES

051 Argent Plata Silver	053 Blanc Blanco White	054 Gris Gris Grey	055 Hêtre Haya Beech	061 Chêne Moyen Roble Maple
062 Poirier Peral Pear	063 Wengué Wengue Wengue	103 Acacia Clair Acacia Clara Light Acacia	104 Acacia Foncé Acacia Oscura Dark Acacia	105 Zebrano Zebrano Zebrano

sigma

SIGMA améliore votre poste de travail grâce à ses nouveaux concepts ergonomiques et esthétiques.

SIGMA mejora los puestos de trabajo aportándoles nuevos conceptos ergonómicos y estéticos.

SIGMA improves workplaces by its ergonomics features and design concepts.

BUREAU
INDIVIDUEL

MESA
INDIVIDUAL

INDIVIDUAL
DESK



PLATEAUX / SOBRE / DESK TOP

Mélamine / Melamina / Melamine: 25 mm
Chant en ABS / Canto ABS / ABS edges

STRUCTURE / ESTRUCTURA / FRAME

Acier: 65 x 74 x 1,5 mm
Acero: 65 x 74 x 1,5 mm
Steel: 65 x 74 x 1,5 mm



* Montée de câbles intégrée / Subida de cables integrada / Cable management built-in frame

FINITION STRUCTURE / ACABADO ESTRUCTURA / FRAME FINISH

Peinture époxy
Pintura epoxi
Epoxy paint

HAUTEUR / ALTURA / HEIGHT

Fixe: 73 mm
Fija: 73 mm
Fixed: 73 mm
Réglable: 811 > 635 mm
Regulable: 811 > 635 mm
Adjustable: 811 > 635 mm

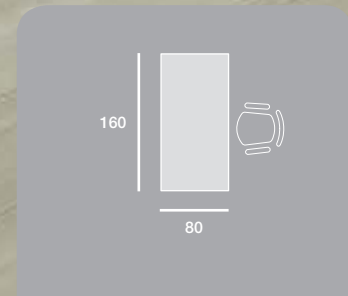

POSTE
COMPACT
SYMÉTRIQUE

PUESTO
COMPACTO
SIMÉTRICO

SYMMETRIC
L-SHAPED
DESK



Piédement métallique à dégagement latéral avec passage de câbles intégré.
Lateral en forma de "L" con pasa cables integrado.
L-shape frame with cable management cover.

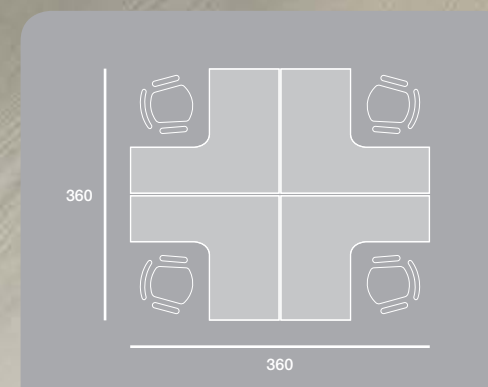

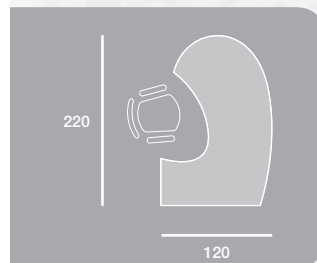

POSTE
COMPACT
ÉXÉCUTIF

PUESTO
COMPACTO
EJECUTIVO

EXECUTIVE
DESK

TABLE DE
RÉUNION

MESA DE
REUNIÓN

MEETING
TABLE



Ronde ou ovale.
Redonda o ovaladas.
Round or oval shape.

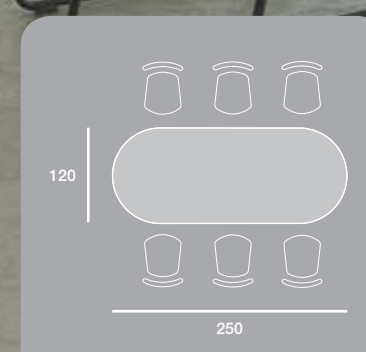



Rehausse d'accueil optionnelle.
 Una opción fácil para resolver un puesto de atención al cliente.
 An easy way to solve a customer service corner.

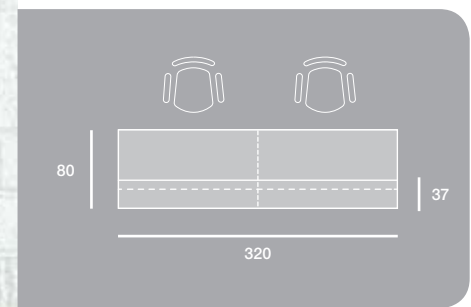



BANQUES
D'ACCUEIL

MOSTRADORES

COUNTERS FOR
TABLE TOPS



MODÈLES | VARIANTES | VERSIONS

MODÈLE / VARIANTES / VERSIONS	TYPE / TIPO / TYPE	DIMENSIONS / MEDIDAS / MEASUREMENTS	RÉFÉRENCE / REFERENCIA / CODE	
 Bureau individuel Mesa individual Rectangular desks	Coins droits / Cantos rectos / Square edges	180 x 80 cm	231.102.-..	
		160 x 80 cm	231.103.-..	
	Coins arrondis / Cantos redondos / Round edges	140 x 80cm	231.104.-..	
		120 x 80cm	231.105.-..	
		80 x 80cm	231.107.-..	
		180 x 80 cm	231.402.-..	
		160 x 80 cm	231.403.-..	
		140 x 80cm	231.404.-..	
		120 x 80cm	231.405.-..	
		80 x 80cm	231.407.-..	
			Droit / Derecha / Right	Gauche / Izquierda / Left
 Bureau onde Mesa ola Wave shape desks	Coins droits / Cantos rectos / Square edges	180 x 100 - 80 cm	231.132.-..	
		160 x 100 - 80 cm	231.133.-..	
	Coins arrondis / Cantos redondos / Round edges	140 x 100 - 80 cm	231.134.-..	
			231.135.-..	
			231.136.-..	
			231.137.-..	
		180 x 100 - 80 cm	231.422.-..	
		160 x 100 - 80 cm	231.423.-..	
		140 x 100 - 80 cm	231.424.-..	
			231.425.-..	
			231.426.-..	
			231.427.-..	
			Droit / Derecha / Right	Gauche / Izquierda / Left
 Poste compact exécutif Compacto ejecutivo Executive desks	Coins droits / Cantos rectos / Square edges	220 x 120 cm	231.690.-..	
		200 x 120 cm	231.692.-..	
			231.691.-..	
			231.693.-..	
			Droit / Derecha / Right	Gauche / Izquierda / Left
 Poste compact VII Compacto VII L-shaped desks VII	Coins droits / Cantos rectos / Square edges	L. 180 cm	231.730.-..	
		180 x 160 cm	231.731.-..	
		180 x 140 cm	231.732.-..	
		180 x 120 cm	231.733.-..	
			231.734.-..	
			231.735.-..	
		L. 160 cm	231.750.-..	
		160 x 160 cm	231.751.-..	
		160 x 140 cm	231.752.-..	
		160 x 120 cm	231.753.-..	
			231.754.-..	
			231.755.-..	
	Coins arrondis / Cantos redondos / Round edges	L. 180 cm	231.842.-..	
		180 x 160 cm	231.843.-..	
		L. 160 cm	231.844.-..	
		160 x 160 cm	231.845.-..	
			Droit / Derecha / Right	Gauche / Izquierda / Left
 Poste compact VIII Compacto VIII L-shaped desks VIII	Coins droits / Cantos rectos / Square edges	160 x 160 cm	231.712.-..	
		140 x 140 cm	231.714.-..	
	Coins arrondis / Cantos redondos / Round edges	160 x 160 cm	231.904.-..	
		140 x 140 cm	231.906.-..	
			Droit / Derecha / Right	Gauche / Izquierda / Left
 Poste compact symétrique Compacto simétrico L-shaped symmetrical desks	Coins droits / Cantos rectos / Square edges	180 x 180 cm	231.670.-..	
		160 x 160 cm	231.671.-..	
	Coins arrondis / Cantos redondos / Round edges	140 x 140 cm	231.672.-..	
			231.880.-..	
			231.882.-..	
			231.884.-..	







MODÈLE / VARIANTES / VERSIONS	DIMENSIONS / MEDIDAS / MEASUREMENTS	RÉFÉRENCE / REFERENCIA / CODE
	500 x 120 cm	234.104.-..
	450 x 120 cm	234.106.-..
	400 x 120 cm	234.108.-..
	350 x 120 cm	234.110.-..
	300 x 120 cm	234.112.-..
	250 x 120 cm	234.114.-..
	200 x 120 cm	234.116.-..
	Ø 130 cm	234.118.-..
	Ø 116 cm	234.120.-..

FINITIONS | ACABADOS | FINISHES

STRUCTURE / ESTRUCTURA / FRAME | PLATEAUX / SOBRE / DESK TOP



	Argent Plata Silver	060	Blanc Blanco White	064	Gris Gris Grey	065	Hêtre Haya Beech	066	Chêne Moyen Roble Maple	067	Poirier Peral Pear
		Blanc Blanco White	068	Wengué Wengue Wengue	706	Acacia Clair Acacia Clara Light Acacia	707	Acacia Foncé Acacia Oscura Dark Acacia	708	Zebrano Zebrano Zebrano	100
		Graphite Grafito Graphite	096	Blanc Blanco White	097	Gris Gris Grey	098	Hêtre Haya Beech	099	Chêne Moyen Roble Maple	101
		163	Blanc Blanco White	180	Gris Gris Grey	181	Hêtre Haya Beech	182	Chêne Moyen Roble Maple	183	Poirier Peral Pear
	184	Wengué Wengue Wengue	715	Acacia Clair Acacia Clara Light Acacia	716	Acacia Foncé Acacia Oscura Dark Acacia	717	Zebrano Zebrano Zebrano			

COMPLÉMENTS | COMPLEMENTOS | COMPLEMENTS

MODÈLE / VARIANTES / VERSIONS	DIMENSIONS / MEDIDAS / MEASUREMENTS	RÉFÉRENCE / REFERENCIA / CODE
 <p>Retour secrétaire Ala taquígrafa Return</p>	Coins droits / Cantos rectos / Square edges	98 X 60 cm
	Coins arrondis / Cantos redondos / Round edges	98 X 60 cm
	- Pour bureaux onde / Para mesas ola / For wave desks:	
	Coins droits / Cantos rectos / Square edges	82,8 X 60 cm
	Coins arrondis / Cantos redondos / Round edges	82,8 X 60 cm
		<p>À droite / Derecha / Right À gauche / Izquierda / Left</p> <p>231.305.-.- 231.306.-.-</p> <p>231.309.-.- 231.310.-.-</p> <p>231.307.-.- 231.308.-.-</p> <p>231.311.-.- 231.312.-.-</p>
 <p>Convivialité Gota ejecutiva Teardrop</p>	118 x 158 cm	231.325.-.-
 <p>Demi-rond Semicircular Semicircular</p>	80 x 40 cm	231.324.-.-
 <p>Demi-rond entre 2 bureaux Semicircular para 2 mesas Semicircular for two desks</p>	161 x 70 cm	231.326.-.-
 <p>Semi-elliptique Semielliptic</p>	161 x 40 cm	231.327.-.-
 <p>Angle concave 90° Ángulo cóncavo 90° 90° Concave angle</p>	80 x 80 cm	421.016.-.-

FINITIONS ACABADOS FINISHES

053	Blanc Blanco White	054	Gris Gris Grey	055	Hêtre Haya Beech
061	Chêne Moyen Roble Maple	062	Poirier Peral Pear	116	Wengué Wengue Wengue
103	Acacia Clair Acacia Clara Light Acacia	104	Acacia Foncé Acacia Oscura Dark Acacia	105	Zebrano Zebrano Zebrano



MODÈLE / VARIANTES / VERSIONS	DIMENSIONS / MEDIDAS / MEASUREMENTS	RÉFÉRENCE / REFERENCIA / CODE
 <p>Bureau secrétaire Mesa taquígrafa Shorthand desk</p>	110 x 60 cm	231.304.-.-
 <p>Banques d'accueil Mostradores Counters for table top</p>	180 x 37 cm	1.233.004.-.-
	160 x 37 cm	1.233.006.-.-
	140 x 37 cm	1.233.008.-.-
	120 x 37 cm	1.233.010.-.-
	80 x 37 cm	1.233.012.-.-
	117 x 47,3 cm (angle 90° / ángulo 90° / 90° angle)	1.233.020.-.-

FINITIONS ACABADOS FINISHES

053	Blanc Blanco White	054	Gris Gris Grey	055	Hêtre Haya Beech
061	Chêne Moyen Roble Maple	062	Poirier Peral Pear	116	Wengué Wengue Wengue
103	Acacia Clair Acacia Clara Light Acacia	104	Acacia Foncé Acacia Oscura Dark Acacia	105	Zebrano Zebrano Zebrano

FINITIONS | ACABADOS | FINISHES

STRUCTURE / ESTRUCTURA / FRAME | PLATEAUX / SOBRE / DESK TOP

 <p>Argent Plata Silver RAL 9006</p>	060	Blanc Blanco White	064	Gris Gris Grey	065	Hêtre Haya Beech	066	Chêne Moyen Roble Maple	067	Poirier Peral Pear
	068	Wengué Wengue Wengue	706	Acacia Clair Acacia Clara Light Acacia	707	Acacia Foncé Acacia Oscura Dark Acacia	708	Zebrano Zebrano Zebrano		
 <p>Blanc Blanco White RAL 9016</p>	096	Blanc Blanco White	097	Gris Gris Grey	098	Hêtre Haya Beech	099	Chêne Moyen Roble Maple	100	Poirier Peral Pear
	101	Wengué Wengue Wengue	709	Acacia Clair Acacia Clara Light Acacia	710	Acacia Foncé Acacia Oscura Dark Acacia	711	Zebrano Zebrano Zebrano		
 <p>Graphite Grafito Graphite RAL 7022</p>	163	Blanc Blanco White	180	Gris Gris Grey	181	Hêtre Haya Beech	182	Chêne Moyen Roble Maple	183	Poirier Peral Pear
	184	Wengué Wengue Wengue	715	Acacia Clair Acacia Clara Light Acacia	716	Acacia Foncé Acacia Oscura Dark Acacia	717	Zebrano Zebrano Zebrano		

CLOISONNETTES FRONTALES | PLAFONES | FRONT SCREENS

1 NIVEAU / 1 NIVEL / 1 LEVEL

2 NIVEAUX / 2 NIVELES / 2 LEVELS

MODÈLE / VARIANTES / VERSIONS	L.	RÉFÉRENCE / REFERENCIA / CODE			MODÈLE / VARIANTES / VERSIONS	L.	RÉFÉRENCE / REFERENCIA / CODE		
									
Indiv. Vis à vis / Enfrentadas / Face to face					Indiv. Vis à vis / Enfrentadas / Face to face				
180 cm		386.008.-	386.108.-	386.208.-	180 cm		386.021.-	386.121.-	386.221.-
160 cm		386.009.-	386.109.-	386.209.-	160 cm		386.022.-	386.122.-	386.222.-
140 cm		386.010.-	386.110.-	386.210.-	140 cm		386.023.-	386.123.-	386.223.-
120 cm		386.011.-	386.111.-	386.211.-	120 cm		386.024.-	386.124.-	386.224.-
100 cm		386.012.-	386.112.-	386.212.-	100 cm		386.025.-	386.125.-	386.225.-
80 cm		386.013.-	386.113.-	386.213.-	80 cm		386.026.-	386.126.-	386.226.-

Mélangine
Melamina
Melamine

Mélangine
Melamina
Melamine

FINITIONS ACABADOS FINISHES		007		051	
	Graphite Grafito Graphite		Argent Plata Silver		
053	Blanc Blanco White	054	Gris Gris Grey	055	Hêtre Haya Beech
061	Chêne Moyen Roble Maple	062	Poirier Peral Pear	116	Wengué Wengue Wengue
103	Acacia Clair Acacia Clara Light Acacia	104	Acacia Foncé Acacia Oscura Dark Acacia	105	Zebrano Zebrano Zebrano

FINITIONS ACABADOS FINISHES		204		088	
	Graphite Grafito Graphite		Argent Plata Silver		
081	Blanc Blanco White	197	Gris Gris Grey	198	Hêtre Haya Beech
199	Chêne Moyen Roble Maple	200	Poirier Peral Pear	202	Wengué Wengue Wengue
103	Acacia Clair Acacia Clara Light Acacia	104	Acacia Foncé Acacia Oscura Dark Acacia	105	Zebrano Zebrano Zebrano

FINITIONS ACABADOS FINISHES		007		051	
	Graphite Grafito Graphite		Argent Plata Silver		
053	Blanc Blanco White	054	Gris Gris Grey	055	Hêtre Haya Beech
061	Chêne Moyen Roble Maple	062	Poirier Peral Pear	116	Wengué Wengue Wengue
103	Acacia Clair Acacia Clara Light Acacia	104	Acacia Foncé Acacia Oscura Dark Acacia	105	Zebrano Zebrano Zebrano

Tissu
Tapizado
Upholstered

FINITIONS ACABADOS FINISHES		204		088	
	Graphite Grafito Graphite		Argent Plata Silver		
081	Blanc Blanco White	197	Gris Gris Grey	198	Hêtre Haya Beech
199	Chêne Moyen Roble Maple	200	Poirier Peral Pear	202	Wengué Wengue Wengue
103	Acacia Clair Acacia Clara Light Acacia	104	Acacia Foncé Acacia Oscura Dark Acacia	105	Zebrano Zebrano Zebrano

Tissu
Tapizado
Upholstered

Cf. page 574
Ver pagina 574
See page 574

Cf. page 574
Ver pagina 574
See page 574

FINITIONS ACABADOS FINISHES		007		051	
	Graphite Grafito Graphite		Argent Plata Silver		
053	Blanc Blanco White	054	Gris Gris Grey	055	Hêtre Haya Beech
061	Chêne Moyen Roble Maple	062	Poirier Peral Pear	116	Wengué Wengue Wengue
103	Acacia Clair Acacia Clara Light Acacia	104	Acacia Foncé Acacia Oscura Dark Acacia	105	Zebrano Zebrano Zebrano

Méthacrylate
Metacrilato
Methacrylate

FINITIONS ACABADOS FINISHES		204		088	
	Graphite Grafito Graphite		Argent Plata Silver		
081	Blanc Blanco White	197	Gris Gris Grey	198	Hêtre Haya Beech
199	Chêne Moyen Roble Maple	200	Poirier Peral Pear	202	Wengué Wengue Wengue
103	Acacia Clair Acacia Clara Light Acacia	104	Acacia Foncé Acacia Oscura Dark Acacia	105	Zebrano Zebrano Zebrano

Avec méthacrylate et tapissée
Con metacrilato y tapizado
With methacrylate and upholstered

411 Transparent
Transparente
Clear

412 Blanc opaque
Translúcido
Translucent

406 Transparent
Transparente
Clear

427 Blanc opaque
Translúcido
Translucent



Large éventail de styles et compositions avec un minimum de références.

Con esta serie se obtiene una gran versatilidad de estilos y composiciones con un número reducido de referencias.

Great variety of styles and compositions within the same range and easy to order.

BUREAU
INDIVIDUEL

MESA
INDIVIDUAL



INDIVIDUAL
DESK

PLATEAUX / SOBRE / DESK TOP

Mélamine / Melamina / Melamine: 25 mm

Chant en ABS / Canto ABS / ABS edges

STRUCTURE / ESTRUCTURA / FRAME

Acier Acero Steel	6,5 cm  75 cm	Mélamine Melamina Melamine	2,5 cm  67,5 cm
-------------------------	--	----------------------------------	--

* Montée de câbles intégrée uniquement pour T2 / Subida de cables integrada para T2 / Cable management built-in frame for T2

STRUCTURE EN ACIER / ESTRUCTURA ACERO / STEEL FRAME

Peinture époxy
Pintura epoxi
Epoxy paint

HAUTEUR / ALTURA / HEIGHT

73 mm

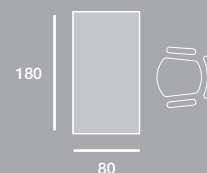



POSTE COMPACT
ÉXÉCUTIF

COMPACTO
EJECUTIVO

EXECUTIVE
DESK

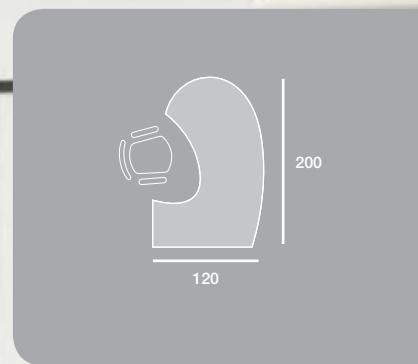

POSTE
COMPACT

PUESTO
COMPACTO

L-SHAPED
DESKS



Passe-câbles extractible.
Perfil de subida de cables.
Cable beam.

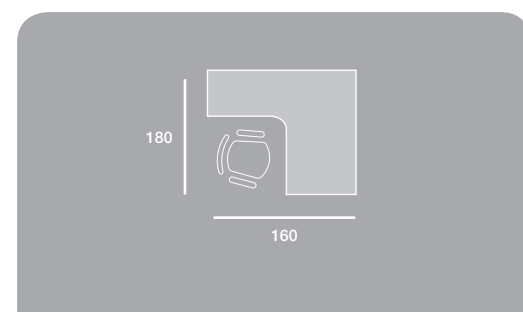

| BUREAU IV

| FORMA IV

| IV SHAPE

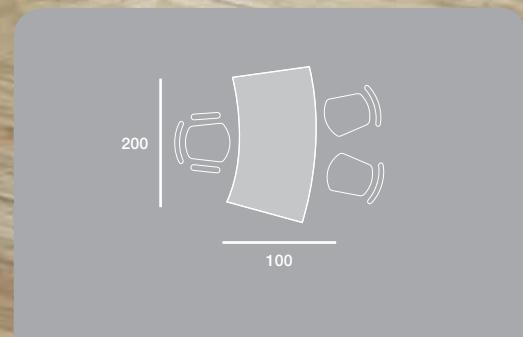

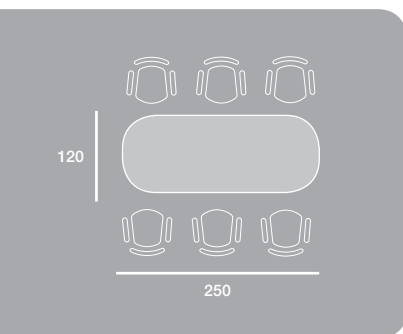







TABLES DE
RÉUNION

MESAS DE
REUNIÓN

MEETING
TABLES

MODÈLES | VARIANTES | VERSIONS

T3

MODÈLE / VARIANTES / VERSIONS	DIMENSIONS / MEDIDAS / MEASUREMENTS	RÉFÉRENCE / REFERENCIA / CODE									
 <p>Bureau individuel IV Forma IV Shaped desk (IV)</p>	200 x 100 cm	601.107.---									
<p>FINITIONS ACABADOS FINISHES</p> <table border="0"> <tr> <td>053 Blanc Blanco White</td> <td>197 Gris Gris Grey</td> <td>198 Hêtre Haya Beech</td> </tr> <tr> <td>199 Chêne Moyen Roble Maple</td> <td>200 Poirier Peral Pear</td> <td>202 Wengué Wengue</td> </tr> <tr> <td>103 Acacia Clair Acacia Clara Light Acacia</td> <td>104 Acacia Foncé Acacia Oscura Dark Acacia</td> <td>105 Zebrano Zebrano Zebrano</td> </tr> </table>			053 Blanc Blanco White	197 Gris Gris Grey	198 Hêtre Haya Beech	199 Chêne Moyen Roble Maple	200 Poirier Peral Pear	202 Wengué Wengue	103 Acacia Clair Acacia Clara Light Acacia	104 Acacia Foncé Acacia Oscura Dark Acacia	105 Zebrano Zebrano Zebrano
053 Blanc Blanco White	197 Gris Gris Grey	198 Hêtre Haya Beech									
199 Chêne Moyen Roble Maple	200 Poirier Peral Pear	202 Wengué Wengue									
103 Acacia Clair Acacia Clara Light Acacia	104 Acacia Foncé Acacia Oscura Dark Acacia	105 Zebrano Zebrano Zebrano									
 <p>Bureau individuel Mesa individual Rectangular desks</p>	180 x 80 cm 160 x 80 cm 140 x 80 cm 120 x 80 cm 100 x 80 cm 80 x 80 cm	601.101.--- 601.102.--- 601.103.--- 601.104.--- 601.105.--- 601.106.---									
 <p>Poste compact B Compacto B L-shaped desk B</p>	180 x 120 cm 160 x 120 cm	<table border="0"> <tr> <td>Droit / Derecha / Right</td> <td>Gauche / Izquierda / Left</td> </tr> <tr> <td>601.320.---</td> <td>601.321.---</td> </tr> <tr> <td>601.322.---</td> <td>601.323.---</td> </tr> </table>	Droit / Derecha / Right	Gauche / Izquierda / Left	601.320.---	601.321.---	601.322.---	601.323.---			
Droit / Derecha / Right	Gauche / Izquierda / Left										
601.320.---	601.321.---										
601.322.---	601.323.---										
 <p>Poste compact C Compacto C L-shaped desk C</p>	180 x 160 cm 160 x 160 cm	<table border="0"> <tr> <td>Droit / Derecha / Right</td> <td>Gauche / Izquierda / Left</td> </tr> <tr> <td>601.130.---</td> <td>601.131.---</td> </tr> <tr> <td>601.132.---</td> <td>601.133.---</td> </tr> </table>	Droit / Derecha / Right	Gauche / Izquierda / Left	601.130.---	601.131.---	601.132.---	601.133.---			
Droit / Derecha / Right	Gauche / Izquierda / Left										
601.130.---	601.131.---										
601.132.---	601.133.---										
 <p>Poste compact exécutif Compacto ejecutivo Executive desks</p>	200 x 120 cm	<table border="0"> <tr> <td>Droit / Derecha / Right</td> <td>Gauche / Izquierda / Left</td> </tr> <tr> <td>601.342.---</td> <td>601.343.---</td> </tr> </table>	Droit / Derecha / Right	Gauche / Izquierda / Left	601.342.---	601.343.---					
Droit / Derecha / Right	Gauche / Izquierda / Left										
601.342.---	601.343.---										
 <p>Table de réunion rectangulaire Mesa de reunión rectangular Rectangular meeting table</p>	250 x 120 cm 200 x 120 cm	604.001.--- 604.002.---									
 <p>Table de réunion ovale Mesa de reunión ovalada Oval meeting table</p>	250 x 120 cm 200 x 120 cm	604.003.--- 604.004.---									

FINITIONS | ACABADOS | FINISHES

STRUCTURE / ESTRUCTURA / FRAME | PLATEAUX / SOBRE / DESK TOP

T3 Piétements mélamine Lateral melamina Panel legs	075 Blanc Blanco White	054 Gris Gris Grey	055 Hêtre Haya Beech	061 Chêne Moyen Roble Maple	062 Poirier Peral Pear
	116 Wengué Wengue	694 Acacia Clair Acacia Clara Light Acacia	695 Acacia Foncé Acacia Oscura Dark Acacia	696 Zebrano Zebrano Zebrano	

MODÈLES | VARIANTES | VERSIONS

T2

MODÈLE / VARIANTES / VERSIONS	DIMENSIONS / MEDIDAS / MEASUREMENTS	RÉFÉRENCE / REFERENCIA / CODE						
 <p>Bureau individuel Mesa individual Rectangular desks</p>	180 x 80 cm 160 x 80 cm 140 x 80 cm 120 x 80 cm 100 x 80 cm 80 x 80 cm	601.201.--- 601.202.--- 601.203.--- 601.204.--- 601.205.--- 601.206.---						
 <p>Poste compact B Compacto B L-shaped desk B</p>	180 x 120 cm 160 x 120 cm	<table border="0"> <tr> <td>Droit / Derecha / Right</td> <td>Gauche / Izquierda / Left</td> </tr> <tr> <td>601.420.---</td> <td>601.421.---</td> </tr> <tr> <td>601.422.---</td> <td>601.423.---</td> </tr> </table>	Droit / Derecha / Right	Gauche / Izquierda / Left	601.420.---	601.421.---	601.422.---	601.423.---
Droit / Derecha / Right	Gauche / Izquierda / Left							
601.420.---	601.421.---							
601.422.---	601.423.---							
 <p>Poste compact exécutif Compacto ejecutivo Executive desks</p>	200 x 120 cm	<table border="0"> <tr> <td>Droit / Derecha / Right</td> <td>Gauche / Izquierda / Left</td> </tr> <tr> <td>601.442.---</td> <td>601.443.---</td> </tr> </table>	Droit / Derecha / Right	Gauche / Izquierda / Left	601.442.---	601.443.---		
Droit / Derecha / Right	Gauche / Izquierda / Left							
601.442.---	601.443.---							







FINITIONS | ACABADOS | FINISHES





STRUCTURE / ESTRUCTURA / FRAME | PLATEAUX / SOBRE / DESK TOP

T2 Piétements en métal Lateral metálico T-shape frame	060 Blanc Blanco White	064 Gris Gris Grey	065 Hêtre Haya Beech	066 Chêne Moyen Roble Maple	067 Poirier Peral Pear
	068 Wengué Wengue	706 Acacia Clair Acacia Clara Light Acacia	707 Acacia Foncé Acacia Oscura Dark Acacia	708 Zebrano Zebrano Zebrano	

| COMPLÉMENTS | COMPLEMENTOS | COMPLEMENTS

T3 / T2

MODÈLE / VARIANTES / VERSIONS	DIMENSIONS / MEDIDAS / MEASUREMENTS	RÉFÉRENCE / REFERENCIA / CODE	
 Retour secrétaire Ala taquígrafa rectangular Return	100 x 60 cm 80 x 60 cm	601.251.-.- 601.252.-.-	
 Retour secrétaire avec forme Ala taquígrafa con forma Return with shape	100 x 60 cm 80 x 60 cm	À droite / Derecha / Right 601.260.-.- 601.262.-.-	À gauche / Izquierda / Left 601.261.-.- 601.263.-.-
 Retour secrétaire avec caisson Ala taquígrafa con cajonera Return with fixed pedestal	3 Tiroirs / Cajones / Drawers 1 Tiroir / Cajón / Drawer + 1 DS / Archivo / File	100 x 60 cm 80 x 60 cm	601.253.-.- 601.254.-.- 601.255.-.- 601.256.-.-
 Retour secrétaire avec forme et caisson Ala taquígrafa con forma y cajonera Shape return with fixed pedestal	3 Tiroirs / Cajones / Drawers 1 Tiroir / Cajón / Drawer + 1 DS / Archivo / File	100 x 60 cm 80 x 60 cm	601.264.-.- 601.268.-.- 601.266.-.- 601.270.-.- 601.265.-.- 601.269.-.- 601.267.-.- 601.271.-.-
 Retour secrétaire pour bureau IV Ala taquígrafa para mesa IV Return for desk IV	152 x 51,5 cm	À droite / Derecha / Right 601.280.-.-	À gauche / Izquierda / Left 601.281.-.-
 Retour secrétaire pour bureau IV avec caisson Ala taquígrafa para mesa IV con cajonera Return for desk IV with fixed pedestal	3 Tiroirs / Cajones / Drawers 1 Tiroir / Cajón / Drawer + 1 DS / Archivo / File	152 x 51,5 cm	601.282.-.- 601.284.-.- 601.283.-.- 601.285.-.-
 Demi-rond Semicircular	80 x 40 cm	601.334.-.-	

MODÈLE / VARIANTES / VERSIONS	DIMENSIONS / MEDIDAS / MEASUREMENTS	RÉFÉRENCE / REFERENCIA / CODE	
 Demi-rond Semicircular	161 x 40 cm	601.332.-.-	
 Semi-elliptique Semielliptic	50,4 x 43,4 cm	601.333.-.-	
 Angle concave 90° Ángulo cóncavo 90° 90° Concave angle	80 x 80 cm	1.601.030.-.-	
 Banques d'accueil Mostradores Counters for table top	180 x 37 cm 160 x 37 cm 140 x 37 cm 120 x 37 cm 100 x 37 cm 80 x 37 cm Angle concave / Ángulo cóncavo / Concave angle 107 x 37 cm	1.233.004.-.- 1.233.006.-.- 1.233.008.-.- 1.233.010.-.- 1.233.011.-.- 1.233.012.-.- 1.233.021.-.-	

FINITIONS ACABADOS FINISHES

053 Blanc Blanco White	054 Gris Gris Grey	055 Hêtre Haya Beech
061 Chêne Moyen Roble Maple	062 Poirier Peral Pear	116 Wengué Wengue
103 Acacia Clair Acacia Clara Light Acacia	104 Acacia Foncé Acacia Oscura Dark Acacia	105 Zebrano Zebrano

| FINITIONS | ACABADOS | FINISHES







STRUCTURE / ESTRUCTURA / FRAME | PLATEAUX / SOBRE / DESK TOP

Piétements en métal Lateral metálico T-shape frame	060 Blanc Blanco White	064 Gris Gris Grey	065 Hêtre Haya Beech	066 Chêne Moyen Roble Maple	067 Poirier Peral Pear
	068 Wengué Wengue	706 Acacia Clair Acacia Clara Light Acacia	707 Acacia Foncé Acacia Oscura Dark Acacia	708 Zebrano Zebrano	

| CLOISONNETTES FRONTALES | PLAFONES | FRONT SCREENS

1 NIVEAU / 1 NIVEL / 1 LEVEL

2 NIVEAUX / 2 NIVELES / 2 LEVELS

MODÈLE / VARIANTES / VERSIONS		L.	RÉFÉRENCE / REFERENCIA / CODE		MODÈLE / VARIANTES / VERSIONS		L.	RÉFÉRENCE / REFERENCIA / CODE	
<p>PINCES / PINZAS / BRACKET</p> <p>RAL 9006</p>  <p>Indiv. Vis à vis / Enfrentadas / Face to face</p> <p>180 cm 386.008.-.- 160 cm 386.009.-.- 140 cm 386.010.-.- 120 cm 386.011.-.- 80 cm 386.013.-.-</p> <p>Mélamine Melamina Melamine</p>					<p>PINCES / PINZAS / BRACKET</p> <p>RAL 9006</p>  <p>Indiv. Vis à vis / Enfrentadas / Face to face</p> <p>180 cm 386.021.-.- 160 cm 386.022.-.- 140 cm 386.023.-.- 120 cm 386.024.-.- 80 cm 386.026.-.-</p> <p>Mélamine Melamina Melamine</p>				
<p>FINITIONS ACABADOS FINISHES</p> <p>007 Graphite Grafito Graphite 051 Argent Plata Silver</p> <p>053 Blanc Blanco White 054 Gris Gris Grey 055 Hêtre Haya Beech</p> <p>061 Chêne Moyen Roble Maple 062 Poirier Peral Pear 116 Wengué Wengue Wengue</p> <p>103 Acacia Clair Acacia Clara Light Acacia 104 Acacia Foncé Acacia Oscura Dark Acacia 105 Zebrano Zebrano Zebrano</p>					<p>FINITIONS ACABADOS FINISHES</p> <p>204 Graphite Grafito Graphite 088 Argent Plata Silver</p> <p>081 Blanc Blanco White 197 Gris Gris Grey 198 Hêtre Haya Beech</p> <p>199 Chêne Moyen Roble Maple 200 Poirier Peral Pear 202 Wengué Wengue Wengue</p> <p>103 Acacia Clair Acacia Clara Light Acacia 104 Acacia Foncé Acacia Oscura Dark Acacia 105 Zebrano Zebrano Zebrano</p>				
 <p>Indiv. Vis à vis / Enfrentadas / Face to face</p> <p>180 cm 386.008.000 160 cm 386.009.000 140 cm 386.010.000 120 cm 386.011.000 80 cm 386.013.000</p> <p>Tissu Tapizado Upholstered</p> <p>FINITIONS ACABADOS FINISHES Cf. page 574 Ver pagina 574 See page 574</p>					 <p>Indiv. Vis à vis / Enfrentadas / Face to face</p> <p>180 cm 386.021.000 160 cm 386.022.000 140 cm 386.023.000 120 cm 386.024.000 80 cm 386.026.000</p> <p>Tissu Tapizado Upholstered</p> <p>FINITIONS ACABADOS FINISHES Cf. page 574 Ver pagina 574 See page 574</p>				
 <p>Indiv. Vis à vis / Enfrentadas / Face to face</p> <p>180 cm 386.008.-.- 160 cm 386.009.-.- 140 cm 386.010.-.- 120 cm 386.011.-.- 80 cm 386.013.-.-</p> <p>Méthacrylate Metacrilato Methacrylate</p> <p>FINITIONS ACABADOS FINISHES 411 Transparent Transparente Clear 412 Blanc opaque Translúcido Transparent</p>					 <p>Indiv. Vis à vis / Enfrentadas / Face to face</p> <p>180 cm 386.021.-.- 160 cm 386.022.-.- 140 cm 386.023.-.- 120 cm 386.024.-.- 80 cm 386.026.-.-</p> <p>Avec méthacrylate et tapissée Con metacrilato y tapizado With methacrylate and upholstered</p> <p>FINITIONS ACABADOS FINISHES 406 Transparent Transparente Clear 427 Blanc opaque Translúcido Transparent</p>				



ROCK K3

La série ROCK 3 se caractérise par son pied panneau mélaminé. Elle vous permet de meubler votre bureau au meilleur prix possible, avec une grande gamme de finitions.

ROCK 3 se caracteriza por un lateral tipo panel. Permite amueblar las oficinas al mejor precio, con gran variedad de acabados.

ROCK 3 melamine panel legs range is an affordable, high quality and stylish furniture, enabling customers to furnish their office space within a specific budget,

BUREAU INDIVIDUEL
AVEC RETOUR

MESA INDIVIDUAL
CON ALA

INDIVIDUAL DESK
WITH RETURN



PLATEAUX / SOBRE / DESK TOP

Mélamine / Melamina / Melamine: 25 mm

Chant en ABS / Canto ABS / ABS edges

STRUCTURE / ESTRUCTURA / FRAME

Mélamine / Melamina / Melamine

25

HAUTEUR / ALTURA / HEIGHT

73 mm





Entretoise en PVC.
Distanciador de plástico.
Plastic top spacers.

POSTES
COMPACTS
EN VIS À VIS

PUESTOS
COMPACTOS
ENFRENTADOS

L-SHAPE
FACE TO FACE
DESKS

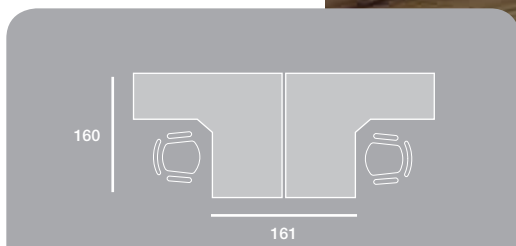

POSTE
COMPACT
ÉXÉCUTIF

PUESTO
COMPACTO
EJECUTIVO

EXECUTIVE
DESK

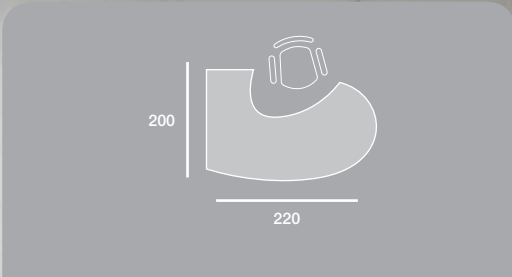
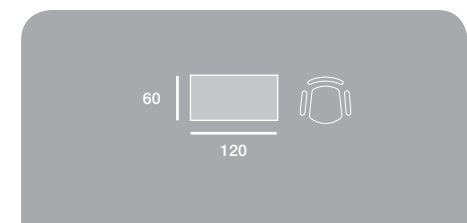

TABLE
BASSE

MESA DE
CENTRO

COFFEE
TABLE

Design simple et élégant.
Un diseño simple y elegante.
A simple and smart design.



| TABLES DE
| RÉUNION

| MESAS DE
| REUNIÓN

| MEETING
| TABLES

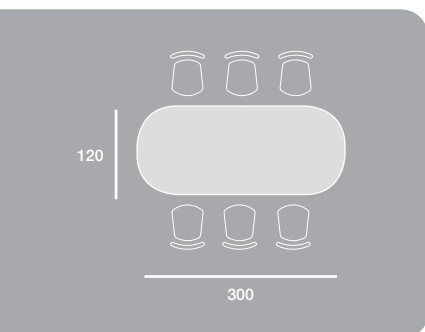



MODÈLES | VARIANTES | VERSIONS

MODÈLE / VARIANTES / VERSIONS	DIMENSIONS / MEDIDAS / MEASUREMENTS	RÉFÉRENCE / REFERENCIA / CODE
 Bureau rectangulaire Mesa individual Rectangular desks	180 x 80 cm 160 x 80 cm 140 x 80 cm 120 x 80 cm 80 x 80 cm	431.101.-... 431.102.-... 431.103.-... 431.104.-... 431.105.-...

FINITIONS | ACABADOS | FINISHES

053	Blanc Blanco White	054	Gris Gris Grey	055	Hêtre Haya Beech	061	Chêne Moyen Roble Maple	062	Poirier Peral Pear
116	Wengué Wengue Wengue	103	Acacia Clair Acacia Clara Light Acacia	104	Acacia Foncé Acacia Oscura Dark Acacia	105	Zebrano Zebrano Zebrano		



MODÈLES | VARIANTES | VERSIONS

MODÈLE / VARIANTES / VERSIONS	DIMENSIONS / MEDIDAS / MEASUREMENTS	RÉFÉRENCE / REFERENCIA / CODE	
 Poste compact VII Compacto VII L-shaped desks VII	180 x 120 cm 160 x 120 cm	Droit / Derecha / Right 431.146.-... 431.160.-...	Gauche / Izquierda / Left 431.147.-... 431.161.-...
 Poste compact exécutif Compacto ejecutivo Executive desks	220 x 138 cm 200 x 138 cm	Droit / Derecha / Right 431.126.-... 431.128.-...	Gauche / Izquierda / Left 431.127.-... 431.129.-...

FINITIONS | ACABADOS | FINISHES

060	Blanc Blanco White	064	Gris Gris Grey	065	Hêtre Haya Beech	066	Chêne Moyen Roble Maple	067	Poirier Peral Pear
068	Wengué Wengue Wengue	706	Acacia Clair Acacia Clara Light Acacia	707	Acacia Foncé Acacia Oscura Dark Acacia	708	Zebrano Zebrano Zebrano		

COMPLÉMENTS | COMPLEMENTOS | COMPLEMENTS

MODÈLE / VARIANTES / VERSIONS	DIMENSIONS / MEDIDAS / MEASUREMENTS	RÉFÉRENCE / REFERENCIA / CODE
 Bureau secrétaire Mesa taquígrafa Shorthand desk	110 x 60 cm	431.114.-...
 Retour secrétaire Ala taquígrafa Return	98 x 60 cm	431.115.-...
 Angle concave 90° Ángulo cóncavo 90° 90° Concave angle	123 X 78,3 cm	431.017.-...
 Table basse Mesa centro Coffee table	120 x 60 cm 95 x 95 cm 60 x 60 cm	431.315.-... 431.316.-... 431.317.-...



FINITIONS ACABADOS FINISHES

053	Blanc Blanco White	054	Gris Gris Grey	055	Hêtre Haya Beech
061	Chêne Moyen Roble Maple	062	Poirier Peral Pear	116	Wengué Wengue Wengue
103	Acacia Clair Acacia Clara Light Acacia	104	Acacia Foncé Acacia Oscura Dark Acacia	105	Zebrano Zebrano Zebrano

FINITIONS | ACABADOS | FINISHES

053	Blanc Blanco White	054	Gris Gris Grey	055	Hêtre Haya Beech	061	Chêne Moyen Roble Maple	062	Poirier Peral Pear
063	Wengué Wengue Wengue	103	Acacia Clair Acacia Clara Light Acacia	104	Acacia Foncé Acacia Oscura Dark Acacia	105	Zebrano Zebrano Zebrano		

| COMPLÉMENTS | COMPLEMENTOS | COMPLEMENTS

MODÈLE / VARIANTES / VERSIONS	DIMENSIONS / MEDIDAS / MEASUREMENTS	RÉFÉRENCE / REFERENCIA / CODE
 <p>Demi-rond Semicircular Semicircular</p>	160 x 70 cm	431.119.-..
 <p>Semi-elliptique Semielliptico Semielliptic</p>	160 x 40 cm	431.122.-..

| FINITIONS | ACABADOS | FINISHES

060	Blanc Blanco White	064	Gris Gris Grey	065	Hêtre Haya Beech	066	Chêne Moyen Roble Maple	067	Poirier Peral Pear
068	Wengué Wengue Wengue	706	Acacia Clair Acacia Clara Light Acacia	707	Acacia Foncé Acacia Oscura Dark Acacia	708	Zebrano Zebrano Zebrano		

| CLOISONNETTES FRONTALES | PLAFONES | FRONT SCREENS

1 NIVEAU / 1 NIVEL / 1 LEVEL

MODÈLE / VARIANTES / VERSIONS	L.	RÉFÉRENCE / REFERENCIA / CODE	MODÈLE / VARIANTES / VERSIONS	L.	RÉFÉRENCE / REFERENCIA / CODE
 <p>Mélamine Melamina Melamine</p>	Indiv. 180 cm 160 cm 140 cm 120 cm 80 cm	406.004.-.. 406.006.-.. 406.008.-.. 406.010.-.. 406.014.-..	 <p>Mélamine avec rail Melamina con guía Melamine with guide</p>	Indiv. 180 cm 160 cm 140 cm 120 cm 80 cm	406.034.-.. 406.036.-.. 406.038.-.. 406.040.-.. 406.044.-..

FINITIONS
ACABADOS
FINISHES

051	Argent Plata Silver	053	Blanc Blanco White	054	Gris Gris Grey	055	Hêtre Haya Beech	061	Chêne Moyen Roble Maple
062	Poirier Peral Pear	063	Wengué Wengue Wengue	103	Acacia Clair Acacia Clara Light Acacia	104	Acacia Foncé Acacia Oscura Dark Acacia	105	Zebrano Zebrano Zebrano



TAK

C'est une série de direction aux lignes droites et élégantes qui s'éloigne de tout ce qui est prétentieux.

Es una serie direccional que se armoniza para crear un sitio de trabajo funcional y práctico, de líneas rectas y puras en todo su conjunto.

TAK is a solid, straight lined and at the same time elegant looking executive range.

PLATEAUX / SOBRE / DESK TOP

Mélamine / Melamina / Melamine: 40 mm

Chant en ABS / Canto ABS / ABS edges

STRUCTURE / ESTRUCTURA / FRAME

Mélamine / Melamina / Melamine:



FINITION STRUCTURE / ACABADO ESTRUCTURA / FRAME FINISH

Mélamine ou bois vernis Noyer américain
Melamina o madera barnizada de Nogal americano
Melamine or American walnut wood veneer

HAUTEUR / ALTURA / HEIGHT

73 mm

BUREAU DE
DIRECTION
AVEC CRÉDENCE

MESA DE
DIRECCIÓN
CON CREDENCIA

EXECUTIVE
DESK WITH
SIDE CREDENZA

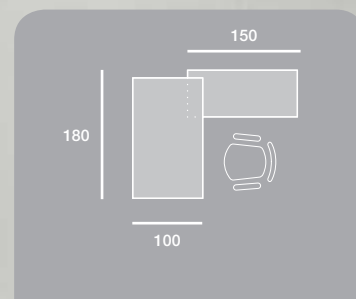

BUREAU DE
DIRECTION
AVEC RETOUR

MESA DE
DIRECCIÓN
CON ALA

EXECUTIVE
DESK WITH
RETURN



Entretoises et patins, finition chromée.
Distanciadores acabados en cromado.
Chrome top spacers.

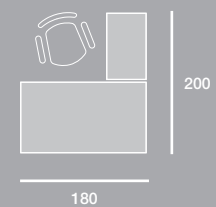

BUREAU DE
DIRECTION

MESA DE
DIRECCIÓN

EXECUTIVE
DESK

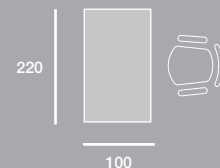
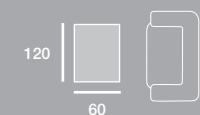

TABLE
BASSE

MESA DE
CENTRO

COFFEE
TABLE

Bureaux de direction disponibles en plusieurs dimensions et finitions.
Mesas de dirección con varias medidas y acabados.
Executive desks with a wide range of measurements and finishes.





| TABLES DE
| RÉUNION

| MESAS DE
| REUNIÓN

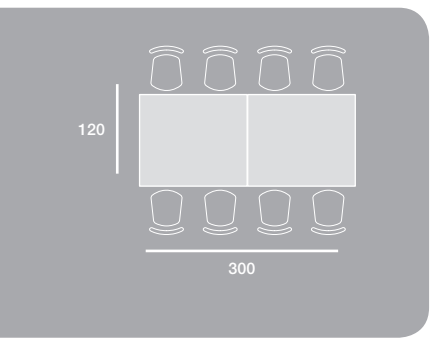
| MEETING
| TABLES



MODÈLES | VARIANTES | VERSIONS

MODÈLE / VARIANTES / VERSIONS	DIMENSIONS / MEDIDAS / MEASUREMENTS	RÉFÉRENCE / REFERENCIA / CODE
 <p>Bureau de direction Mesa de dirección Executive desk</p>	220 x 100 cm 200 x 100 cm 180 x 100 cm 160 x 100 cm	Noyer Américain Nogal Americano American Walnut 561.100.-... 561.400.365 561.101.-... 561.401.365 561.102.-... 561.402.365 561.103.-... 561.403.365
 <p>Bureau de direction pour crédence fixe Mesa de dirección con credencia Executive desk with side credenza</p>	À droite / Derecha / Right 220 x 100 cm 200 x 100 cm 180 x 100 cm 160 x 100 cm À gauche / Izquierda / Left 220 x 100 cm 200 x 100 cm 180 x 100 cm 160 x 100 cm	Noyer Américain Nogal Americano American Walnut 561.150.-... 561.450.365 561.152.-... 561.452.365 561.154.-... 561.454.365 561.156.-... 561.456.365 561.151.-... 561.451.365 561.153.-... 561.453.365 561.155.-... 561.455.365 561.157.-... 561.457.365
 <p>Table de réunion rectangulaire Mesa de reunión rectangular Rectangular meeting table</p>	600 x 120 cm 400 x 120 cm 300 x 120 cm	Noyer Américain Nogal Americano American Walnut 564.202.-... 564.702.365 564.208.-... 564.708.365 564.212.-... 564.712.365
 <p>Table de réunion rectangulaire Mesa de reunión rectangular Rectangular meeting table</p>	250 x 120 cm 200 x 120 cm 120 x 120 cm	564.214.-... 564.714.365 564.216.-... 564.716.365 564.218.-... 564.718.365
 <p>Table de réunion ovale Mesa de reunión ovalada Oval meeting table</p>	600 x 120 cm 400 x 120 cm 300 x 120 cm	Noyer Américain Nogal Americano American Walnut 564.102.-... 564.402.365 564.108.-... 564.408.365 564.112.-... 564.412.365
 <p>Table de réunion ovale Mesa de reunión ovalada Oval meeting table</p>	250 x 120 cm 200 x 120 cm	564.114.-... 564.414.365 564.116.-... 564.416.365
 <p>Table de réunion ovale Mesa de reunión ovalada Oval meeting table</p>	Ø 130 cm	564.118.-... 564.418.365

FINITIONS | ACABADOS | FINISHES

Monochrome
Monocolor
Single-colour

053

Blanc
Blanco
White

103

Acacia Clair
Acacia Clara
Light Acacia

104

Acacia Foncé
Acacia Oscura
Dark Acacia

105

Zebrano
Zebrano
Zebrano

COMPLÉMENTS | COMPLEMENTOS | COMPLEMENTS

MODÈLE / VARIANTES / VERSIONS	TYPE / TIPO / TYPE	DIMENSIONS / MEDIDAS / MEASUREMENTS	RÉFÉRENCE / REFERENCIA / CODE
 <p>Retour secrétaire Ala taquigrafa Return</p>		100 x 60 cm 80 x 60 cm	Noyer Américain Nogal Americano American Walnut 561.110.-... 561.410.365 561.111.-... 561.411.365
 <p>Table basse Mesa centro Coffee table</p>		120 x 60 cm 95 x 95 cm 60 x 60 cm	Noyer Américain Nogal Americano American Walnut 561.115.-... 561.415.365 561.117.-... 561.417.365 561.116.-... 561.416.365
 <p>Crédence à roulettes Credencia con ruedas Side credenza with wheels</p>	À droite / Derecha / Right À gauche / Izquierda / Left	Prof./ Depth. 57 cm Prof./ Depth. 57 cm	Noyer Américain Nogal Americano American Walnut 342.410.-... 342.810.365 342.414.-... 342.814.365 342.418.-... 342.818.365 342.412.-... 342.812.365 342.416.-... 342.816.365 342.420.-... 342.820.365 342.411.-... 342.811.365 342.415.-... 342.815.365 342.419.-... 342.819.365 342.413.-... 342.813.365 342.417.-... 342.817.365 342.421.-... 342.821.365
 <p>Crédence fixe avec portes coulissantes Credencia con puertas correderas Side credenza with sliding doors</p>	À droite / Derecha / Right À gauche / Izquierda / Left	Prof./ Depth. 54,2 cm L. 200 H. 56,2 cm L. 150 H. 56,2 cm L. 200 H. 56,2 cm L. 150 H. 56,2 cm	Noyer Américain Nogal Americano American Walnut 1 porte coulissante / 1 puerta corredera / Sliding door 562.101.-... 562.401.365 562.105.-... 562.405.365 562.102.-... 562.402.365 562.106.-... 562.406.365 2 portes coulissantes / 2 puertas correderas / Sliding doors 562.103.-... 562.403.365 562.107.-... 562.407.365 562.104.-... 562.404.365 562.108.-... 562.408.365
 <p>Caisson à roulettes Cajonera con ruedas Mobile pedestal</p>	3 Tiroirs / Cajones / Drawers 1 Tiroir / Cajón / Drawer + 1 DS / Archivo / File	57 x 44 H. 55,5 cm 57 x 44 H. 55,5 cm	Noyer Américain Nogal Americano American Walnut 342.400.-... 342.800.365 342.401.-... 342.801.365

FINITIONS | ACABADOS | FINISHES

Monochrome
Monocolor
Single-colour

053

Blanc
Blanco
White

103

Acacia Clair
Acacia Clara
Light Acacia

104

Acacia Foncé
Acacia Oscura
Dark Acacia

105

Zebrano
Zebrano
Zebrano

| COMPLÉMENTS | COMPLEMENTOS | COMPLEMENTS

MODÈLE / VARIANTES / VERSIONS	RÉFÉRENCE / REFERENCIA / CODE
 <p>Sous-main Vade Leather pad</p>	561.001.000

| MODÈLES | VARIANTES | VERSIONS

ARMOIRES / ARMARIOS / CABINETS



MODÈLE / VARIANTES / VERSIONS	TYPE / TIPO / TYPE	DIMENSIONS / MEDIDAS / MEASUREMENTS	RÉFÉRENCE / REFERENCIA / CODE
 <p>Armoire ouverte avec étagères Armario con estantes Cabinet shelves</p>	Prof./ Depth. 42 cm	L. 100 H. 201,4 cm L. 100 H. 147 cm L. 100 H. 76,6 cm	Noyer Américain Nogal Americano American Walnut 345.504.-.- 345.704.365 345.502.-.- 345.702.365 345.506.-.- 345.706.365
 <p>Armoire portes en mélamine Armario con puertas de melamina Cabinet with doors</p>	Prof./ Depth. 42 cm	L. 100 H. 201,4 cm L. 100 H. 147 cm L. 100 H. 76,6 cm	345.505.-.- 345.705.365 345.503.-.- 345.703.365 345.507.-.- 345.707.365
 <p>Armoire avec DS Armario con archivos Files cabinet</p>	Prof./ Depth. 42 cm	L. 100 H. 76,6 cm	345.512.-.- 345.712.365

| FINITIONS | ACABADOS | FINISHES

Monochrome Monocolor Single-colour	053 Blanc Blanco White	103 Acacia Clair Acacia Clara Light Acacia	104 Acacia Foncé Acacia Oscura Dark Acacia	105 Zebrano Zebrano Zebrano
--	------------------------------	--	--	-----------------------------------

| MODÈLES | VARIANTES | VERSIONS

ARMOIRES PORTES EN VERRE / ARMARIOS PUERTAS VIDRIO / GLASS DOORS CABINETS

MODÈLE / VARIANTES / VERSIONS	TYPE / TIPO / TYPE	DIMENSIONS / MEDIDAS / MEASUREMENTS	RÉFÉRENCE / REFERENCIA / CODE
 <p>Armoire portes en verre Armario con puertas de vidrio Cabinet with glass doors</p>	Prof./ Depth. 42 cm	L.100 H.201,4 cm L.100 H.147 cm L.100 H.76,6 cm	Noyer Américain Nogal Americano American Walnut 345.505.-.- 345.705.-.- 345.503.-.- 345.703.-.- 345.507.-.- 345.707.-.-
 <p>Armoire portes en verre - portes en mélamine Puertas vidrio - puertas Upper glass doors with low doors</p>	Prof./ Depth. 42 cm	L.100 H.201,4 cm L.100 H.147 cm	345.508.-.- 345.708.-.- 345.509.-.- 345.709.-.-
 <p>Armoire portes en verre - DS Puertas vidrio - archivo Upper glass doors with low files</p>	Prof./ Depth. 42 cm	L.100 H.201,4 cm L.100 H.147 cm	345.510.-.- 345.710.-.- 345.511.-.- 345.711.-.-

| FINITIONS | ACABADOS | FINISHES

VERRE / VIDRIO / GLASS | STRUCTURE / ESTRUCTURA / FRAME

Blanc Blanco White	436 Blanc Blanco White	439 Acacia Clair Acacia Clara Light Acacia	442 Acacia Foncé Acacia Oscura Dark Acacia	445 Zebrano Zebrano Zebrano	497 Noyer Américain Nogal Americano American Walnut
Noir Negro Black	437 Blanc Blanco White	440 Acacia Clair Acacia Clara Light Acacia	443 Acacia Foncé Acacia Oscura Dark Acacia	446 Zebrano Zebrano Zebrano	498 Noyer Américain Nogal Americano American Walnut
Cuivre Cobre Copper	438 Blanc Blanco White	441 Acacia Clair Acacia Clara Light Acacia	444 Acacia Foncé Acacia Oscura Dark Acacia	447 Zebrano Zebrano Zebrano	499 Noyer Américain Nogal Americano American Walnut

Bois vernis
Madera Barnizada
Wood veneer

open

Les besoins actuels de nos centres de travail ont évolué techniquement afin de satisfaire et de s'adapter à notre époque.

Las necesidades actuales en los centros de trabajo han evolucionado técnicamente para satisfacer y adaptarse a estos tiempos.

Current needs at work places have technically developed in order to satisfy us and to adjust to our present time.

PLATEAUX / SOBRE / DESK TOP

Stratiñés / Estratificado / Stratified: 40 mm

STRUCTURE / ESTRUCTURA / FRAME

Aluminium anodisé: 110 x 30 mm 

FINITION STRUCTURE / ACABADO ESTRUCTURA / FRAME FINISH

Peinture époxy / Baño de chrome
Pintura epoxi / Baño cromado
Epoxy paint / Chrome

HAUTEUR / ALTURA / HEIGHT

73 mm

OPTION / OPCIÓN / OPTION

Voile de fond / Faldón / Modesty panel

BUREAU
DIRECTION

MESA DE
DIRECCIÓN

EXECUTIVE
DESK





Sous-mains en cuir.
Vade de piel.
Leather pad.

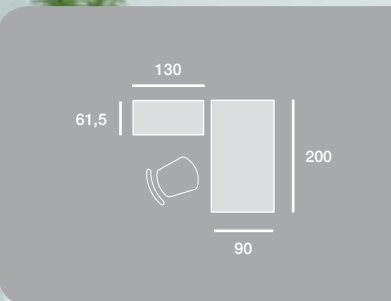

BUREAU
INDIVIDUEL
AVEC CRÉDENCE

MESA
INDIVIDUAL
CON CREDENCIA

EXECUTIVE
DESK WITH
SIDE CREDENZA

TABLE DE
RÉUNION
RONDE

MESA DE
REUNIÓN
REDONDA

ROUND
MEETING
TABLE

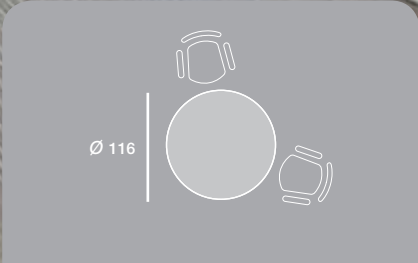

BUREAU DE
DIRECTION
AVEC RETOUR

MESA DE
DIRECCIÓN
CON ALA

EXECUTIVE
DESK WITH
RETURN

Vous pouvez compléter la composition avec un caisson à roulettes non visibles.
Se puede completar el conjunto con una cajonera con ruedas ocultas.
Executive mobile pedestal with hidden wheels is also available.

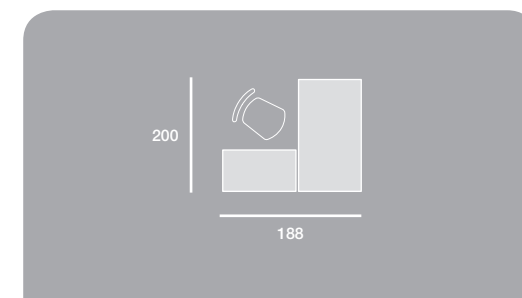

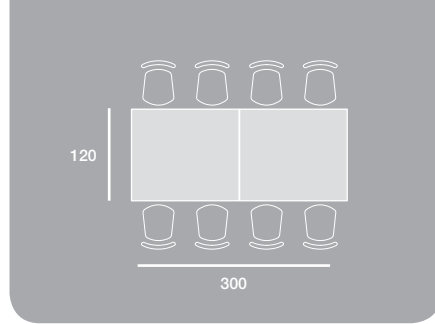





TABLE DE
RÉUNION
RECTANGULAIRE

MESA DE
REUNIÓN
RECTANGULAR

RECTANGULAR
MEETING
TABLE



MODÈLES | VARIANTES | VERSIONS

MODÈLE / VARIANTES / VERSIONS	DIMENSIONS / MEDIDAS / MEASUREMENTS	RÉFÉRENCE / REFERENCIA / CODE
	220 x 100 cm 200 x 100 cm 180 x 100 cm	341.100.-... 341.101.-... 341.102.-...
Bureau de direction Mesa de dirección Executive desk		
	514 x 120 cm 436 x 120 cm 400 x 120 cm 350 x 120 cm 300 x 120 cm	344.104.-... 344.106.-... 344.108.-... 344.110.-... 344.112.-...
	240 x 120 cm 200 x 120 cm	344.114.-... 344.116.-...
	Ø 116 cm Ø 130 cm	344.194.-... 344.192.-...
Tables de réunion Mesas de reunión Meeting tables		

FINITIONS | ACABADOS | FINISHES

STRUCTURE / ESTRUCTURA / FRAME | PLATEAUX / SOBRE / DESK TOP

	Blanc Blanco White	144	Blanc Blanco White	145	Acacia Clair Acacia Clara Light Acacia	146	Acacia Foncé Acacia Oscura Dark Acacia	147	Zebrano Zebrano Zebrano
	Chromée Cromado Chrome	148	Blanc Blanco White	149	Acacia Clair Acacia Clara Light Acacia	150	Acacia Foncé Acacia Oscura Dark Acacia	152	Zebrano Zebrano Zebrano

COMPLÉMENTS | COMPLEMENTOS | COMPLEMENTS



MODÈLE / VARIANTES / VERSIONS	TYPE / TIPO / TYPE	DIMENSIONS / MEDIDAS / MEASUREMENTS	RÉFÉRENCE / REFERENCIA / CODE
	Prof./ Depth. 57 cm	L.158 H.61,5 cm L.130 H.61,5 cm L.115 H.61,5 cm	342.510.-... 342.511.-... 342.512.-...
Crédence à roulettes Credencia con ruedas y sobre de vidrio Side credenza with wheels and glass top			

FINITIONS | ACABADOS | FINISHES

VERRE / VIDRIO / GLASS | STRUCTURE / ESTRUCTURA / FRAME

	Blanc Blanco White	436	Blanc Blanco White	439	Acacia Clair Acacia Clara Light Acacia	442	Acacia Foncé Acacia Oscura Dark Acacia	445	Zebrano Zebrano Zebrano
	Noir Negro Black	437	Blanc Blanco White	440	Acacia Clair Acacia Clara Light Acacia	443	Acacia Foncé Acacia Oscura Dark Acacia	446	Zebrano Zebrano Zebrano
	Cuirre Cobre Copper	438	Blanc Blanco White	441	Acacia Clair Acacia Clara Light Acacia	444	Acacia Foncé Acacia Oscura Dark Acacia	447	Zebrano Zebrano Zebrano

COMPLÉMENTS | COMPLEMENTOS | COMPLEMENTS

MODÈLE / VARIANTES / VERSIONS	TYPE / TIPO / TYPE	DIMENSIONS / MEDIDAS / MEASUREMENTS	RÉFÉRENCE / REFERENCIA / CODE
	Prof./ Depth. 57 cm	L.115 H.61,5 cm L.87 H.61,5 cm L.72 H.61,5 cm	342.513.-... 342.514.-... 342.515.-...
Crédence à roulettes Credencia con ruedas Side credenza with wheels			
	3 Tiroirs / Cajones / Drawers	57 x 44 H.55,5 cm	Gamme basique Gama básica Basic range
Caisson à roulettes Cajonera con ruedas Mobile pedestal	1 Tiroir / Cajón / Drawer + 1 DS / Archivo / File	57 x 44 H.55,5 cm	Haut de gamme Gama alta Top range
			342.500.-... 342.501.-...



Sous-main en cuir
Vade
Leather pad

341.800.000



Cf. page 574 - Série 7
Ver pagina 574 - Serie 7
See page 574 - Serie 7

FINITIONS | ACABADOS | FINISHES



FAÇADES OU PORTES / DELANTERAS O PUERTAS / DOORS OR FRONTS | STRUCTURE / ESTRUCTURA / FRAME

	Blanc Blanco White	053	Blanc Blanco White	171	Acacia Clair Acacia Clara Light Acacia	174	Acacia Foncé Acacia Oscura Dark Acacia	177	Zebrano Zebrano Zebrano
	Acacia Clair Acacia Clara Light Acacia	168	Blanc Blanco White	103	Acacia Clair Acacia Clara Light Acacia	175	Acacia Foncé Acacia Oscura Dark Acacia	178	Zebrano Zebrano Zebrano
	Acacia Foncé Acacia Oscura Dark Acacia	169	Blanc Blanco White	172	Acacia Clair Acacia Clara Light Acacia	104	Acacia Foncé Acacia Oscura Dark Acacia	179	Zebrano Zebrano Zebrano
	Zebrano Zebrano Zebrano	170	Blanc Blanco White	173	Acacia Clair Acacia Clara Light Acacia	176	Acacia Foncé Acacia Oscura Dark Acacia	105	Zebrano Zebrano Zebrano

MODÈLES | VARIANTES | VERSIONS

















ARMOIRES / ARMARIOS / CABINETS

ÉTAGÈRES INCLUSES / ESTANTES INCLUIDOS / INCLUDED SHELVES

MODÈLE / VARIANTES / VERSIONS	TYPE / TIPO / TYPE	DIMENSIONS / MEDIDAS / MEASUREMENTS	RÉFÉRENCE / REFERENCIA / CODE
	Prof./ Depth. 42 cm	L.100 H.201,4 cm L.100 H.147 cm L.100 H.76,6 cm	345.504.-.- 345.502.-.- 345.506.-.-
Armoire ouverte avec étagères Armario con estantes Cabinet shelves			
	Prof./ Depth. 42 cm	L.100 H.201,4 cm L.100 H.147 cm L.100 H.76,6 cm	345.505.-.- 345.503.-.- 345.507.-.-
Armoire portes en mélamine Armario con puertas de melamina Cabinet with doors			
	Prof./ Depth. 42 cm	L.100 H.76,6 cm	345.512.-.-
Armoire avec DS Armario con archivos Files cabinet			

FINITIONS | ACABADOS | FINISHES

PORTES / PUERTAS / DOORS | STRUCTURE / ESTRUCTURA / FRAME

	053 Blanc Blanco White		171 Acacia Clair Acacia Clara Light Acacia		174 Acacia Foncé Acacia Oscura Dark Acacia		177 Zebrano Zebrano Zebrano
	168 Blanc Blanco White		103 Acacia Clair Acacia Clara Light Acacia		175 Acacia Foncé Acacia Oscura Dark Acacia		178 Zebrano Zebrano Zebrano
	169 Blanc Blanco White		172 Acacia Clair Acacia Clara Light Acacia		104 Acacia Foncé Acacia Oscura Dark Acacia		179 Zebrano Zebrano Zebrano
	170 Blanc Blanco White		173 Acacia Clair Acacia Clara Light Acacia		176 Acacia Foncé Acacia Oscura Dark Acacia		105 Zebrano Zebrano Zebrano

MODÈLES | VARIANTES | VERSIONS

ARMOIRES PORTES EN VERRE / ARMARIOS PUERTAS VIDRIO / GLASS DOORS CABINETS

ÉTAGÈRES INCLUSES / ESTANTES INCLUIDOS / INCLUDED SHELVES

MODÈLE / VARIANTES / VERSIONS	TYPE / TIPO / TYPE	DIMENSIONS / MEDIDAS / MEASUREMENTS	RÉFÉRENCE / REFERENCIA / CODE
	Prof./ Depth. 42 cm	L.100 H.198 cm L.100 H.160 cm L.100 H.73 cm	345.505.-.- 345.503.-.- 345.507.-.-
Armoire portes en verre Armario con puertas de vidrio Cabinet with glass doors			
	Prof./ Depth. 42 cm	L.100 H.198 cm L.100 H.160 cm	345.508.-.- 345.509.-.-
Armoire portes en verre - portes en mélamine Puertas vidrio - puertas Upper glass doors with low doors			
	Prof./ Depth. 42 cm	L.100 H.198 cm L.100 H.160 cm	345.510.-.- 345.511.-.-
Armoire portes en verre - DS Puertas vidrio - archivo Upper glass doors with low files			

FINITIONS | ACABADOS | FINISHES

VERRE / VIDRIO / GLASS | STRUCTURE / ESTRUCTURA / FRAME

	436 Blanc Blanco White		439 Acacia Clair Acacia Clara Light Acacia		442 Acacia Foncé Acacia Oscura Dark Acacia		445 Zebrano Zebrano Zebrano
	437 Blanc Blanco White		440 Acacia Clair Acacia Clara Light Acacia		443 Acacia Foncé Acacia Oscura Dark Acacia		446 Zebrano Zebrano Zebrano
	438 Blanc Blanco White		441 Acacia Clair Acacia Clara Light Acacia		444 Acacia Foncé Acacia Oscura Dark Acacia		447 Zebrano Zebrano Zebrano

call

Cette série, très adaptée pour l'aménagement des centres d'appels, est très fonctionnelle et optimise l'espace de travail au maximum en apportant confort et commodité à l'utilisateur.

Representa la optimización del espacio de trabajo. Con unos conceptos de funcionalidad que permiten al usuario gestionar de forma eficaz su confort en su puesto de trabajo.

It represents the optimization in working spaces. Thanks to its functionality concept, users will be able to manage more efficiently their working places.

PLATEAUX / SOBRE / DESK TOP

Mélamine / Melamina / Melamine: 25 mm

FINITION CLOISONS / ACABADOS MAMPARA / SCREEN FINISHES

Mélamine / Melamina / Melamine
Tissu / Tapizado / Upholstered
Acoustique / Acústico / Acoustic
Mét. Transparent / Met. Transparente / Clear methacrylate

HAUTEUR / ALTURA / HEIGHT

Table: Mesa: 73 mm	Cloisons: Paneles: 121 - 140 mm
Desk:	Screens:

INDIVIDUEL
OU ALIGNÉ

INDIVIDUAL
O EN LÍNEA

SINGLE OR
SIDE BY SIDE

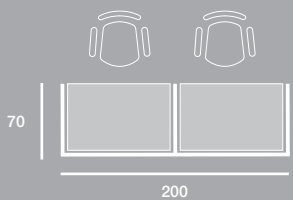

| MARGUERITES

| MARGARITAS

| CLUSTERS

Acoustique
Acústico
Acoustic



| DOUBLE

| DOBLE

| FACE TO FACE

Les cloisonnettes acoustiques vous aideront à contrôler le bruit excessif.
Con los plafones separadores acústicos se reduce el nivel de ruido.
Acoustic panels help to reduce the noise of the room.

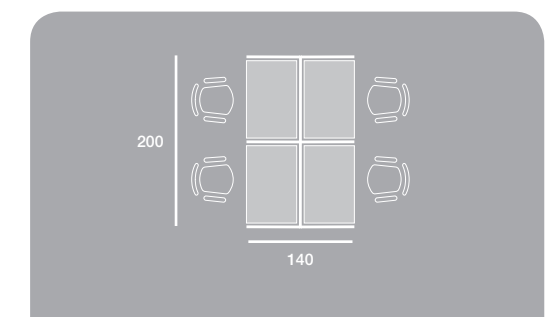
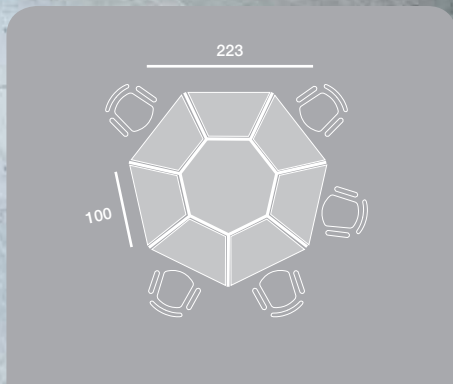



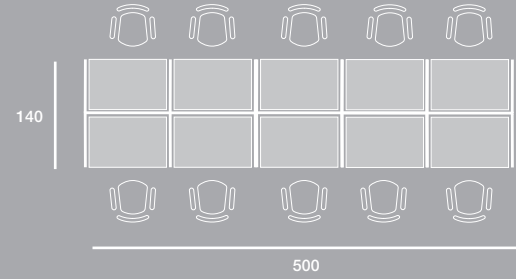

| DOUBLE

| DOBLE

| FACE TO FACE



MODÈLES | VARIANTES | VERSIONS

MODÈLE / VARIANTES / VERSIONS	TYPE / TIPO / TYPE	DIMENSIONS / MEDIDAS / MEASUREMENTS	RÉFÉRENCE / REFERENCIA / CODE
	Modules: / Módulos de: / Moduls of:		19mm 25mm
	H.120 cm	100 x 70 cm 80 x 70 cm	807.314... 807.214... 807.315... 807.215...
Individual terminal Individual terminal Single start unit	H.140 cm	100 x 70 cm 80 x 70 cm	807.304... 807.204... 807.305... 807.205...
	H.120 cm	100 x 70 cm 80 x 70 cm	807.334... 807.234... 807.335... 807.235...
	H.140 cm	100 x 70 cm 80 x 70 cm	807.324... 807.224... 807.325... 807.225...
	H.120 cm	100 x 140 cm 80 x 140 cm	807.364... 807.264... 807.365... 807.265...
Individual central Individual central Single add-on unit	H.140 cm	100 x 140 cm 80 x 140 cm	807.354... 807.254... 807.355... 807.255...
	H.120 cm	100 x 140 cm 80 x 140 cm	807.384... 807.284... 807.385... 807.285...
	H.140 cm	100 x 140 cm 80 x 140 cm	807.374... 807.274... 807.375... 807.275...
	H.120 cm	100 x 140 cm 80 x 140 cm	807.384... 807.284... 807.385... 807.285...
En vis à vis terminal Enfrentados terminal Face to face start unit	H.140 cm	1400 x 70 + 100 cm 1400 x 70 + 80 cm	807.366... 807.266... 807.367... 807.267...
	H.120 cm	1400 x 70 + 100 cm 1400 x 70 + 80 cm	807.356... 807.256... 807.357... 807.257...
	H.140 cm	1400 x 70 + 100 cm 1400 x 70 + 80 cm	807.366... 807.266... 807.367... 807.267...
	H.120 cm	1400 x 70 + 100 cm 1400 x 70 + 80 cm	807.356... 807.256... 807.357... 807.257...
En vis à vis central Enfrentados central Face to face add-on unit	H.120 cm	100 X 157 cm	807.408... 807.408...
	H.140 cm	100 X 157 cm	807.407... 807.407...
	H.120 cm	100 X 157 cm	807.404... 807.404...
	H.140 cm	100 X 157 cm	807.403... 807.403...
Marguerite Margarita Cluster	5P:	Cloisons arrondies / Cantos redondos / Round edges	100 X 157 cm
	7P:	Cloisons arrondies / Cantos redondos / Round edges	100 X 157 cm

FINITIONS ACABADOS FINISHES





096 Blanc Blanco White	064 Gris Gris Grey	065 Hêtre Haya Beech	113 Graphite Grafito Graphite
066 Chêne Moyen Roble Maple	067 Poirier Peral Pear	068 Wengué Wengue Wengue	095 Argent Plata Silver
706 Acacia Clair Acacia Clara Light Acacia	707 Acacia Foncé Acacia Oscura Dark Acacia	708 Zebrano Zebrano Zebrano	

FINITIONS | ACABADOS | FINISHES

CLOISONS / MAMPARA / SCREEN | PLATEAUX / SOBRE / DESK TOP

Mélangine Melamina Melamine	053 Blanc Blanco White	054 Gris Gris Grey	055 Hêtre Haya Beech	061 Chêne Moyen Roble Maple	062 Poirier Peral Pear	116 Wengué Wengue Wengue
	103 Acacia Clair Acacia Clara Light Acacia	104 Acacia Foncé Acacia Oscura Dark Acacia	105 Zebrano Zebrano Zebrano	007 Graphite Grafito Graphite	051 Argent Plata Silver	

MODÈLES | VARIANTES | VERSIONS

MODÈLE / VARIANTES / VERSIONS	TYPE / TIPO / TYPE	DIMENSIONS / MEDIDAS / MEASUREMENTS	RÉFÉRENCE / REFERENCIA / CODE
	Modules: / Módulos de: / Moduls of:		19mm 25mm
	H.120 cm	100 x 70 cm 80 x 70 cm	807.214... 807.214... 807.215... 807.215...
Individual terminal Individual terminal Single start unit	H.140 cm	100 x 70 cm 80 x 70 cm	807.204... 807.204... 807.205... 807.205...
	H.120 cm	100 x 70 cm 80 x 70 cm	807.234... 807.234... 807.235... 807.235...
	H.140 cm	100 x 70 cm 80 x 70 cm	807.224... 807.224... 807.225... 807.225...
	H.120 cm	100 x 140 cm 80 x 140 cm	807.264... 807.264... 807.265... 807.265...
Individual central Individual central Single add-on unit	H.140 cm	100 x 140 cm 80 x 140 cm	807.254... 807.254... 807.255... 807.255...
	H.120 cm	100 x 140 cm 80 x 140 cm	807.284... 807.284... 807.285... 807.285...
	H.140 cm	100 x 140 cm 80 x 140 cm	807.274... 807.274... 807.275... 807.275...
	H.120 cm	100 x 140 cm 80 x 140 cm	807.284... 807.284... 807.285... 807.285...
En vis à vis terminal Enfrentados terminal Face to face start unit	H.140 cm	1400 x 70 + 100 cm 1400 x 70 + 80 cm	807.266... 807.266... 807.267... 807.267...
	H.120 cm	1400 x 70 + 100 cm 1400 x 70 + 80 cm	807.256... 807.256... 807.257... 807.257...
	H.140 cm	1400 x 70 + 100 cm 1400 x 70 + 80 cm	807.266... 807.266... 807.267... 807.267...
	H.120 cm	1400 x 70 + 100 cm 1400 x 70 + 80 cm	807.256... 807.256... 807.257... 807.257...
En vis à vis central Enfrentados central Face to face add-on unit	H.120 cm	100 X 157 cm	807.408... 807.408...
	H.140 cm	100 X 157 cm	807.407... 807.407...
	H.120 cm	100 X 157 cm	807.404... 807.404...
	H.140 cm	100 X 157 cm	807.403... 807.403...
Marguerite Margarita Cluster	5P:	Cloisons arrondies / Cantos redondos / Round edges	100 X 157 cm
	7P:	Cloisons arrondies / Cantos redondos / Round edges	100 X 157 cm

FINITIONS ACABADOS FINISHES

818 Blanc Blanco White	819 Gris Gris Grey	820 Hêtre Haya Beech	816 Graphite Grafito Graphite
821 Chêne Moyen Roble Maple	822 Poirier Peral Pear	823 Wengué Wengue Wengue	817 Argent Plata Silver
824 Acacia Clair Acacia Clara Light Acacia	825 Acacia Foncé Acacia Oscura Dark Acacia	826 Zebrano Zebrano Zebrano	





FINITIONS | ACABADOS | FINISHES

CLOISONS / MAMPARA / SCREEN | PLATEAUX / SOBRE / DESK TOP

Acoustique / Mélangine Acústico / Melamina Acoustic / Melamine	792 Blanc Blanco White	799 Gris Gris Grey	802 Hêtre Haya Beech	803 Chêne Moyen Roble Maple	811 Poirier Peral Pear	812 Wengué Wengue Wengue
	813 Acacia Clair Acacia Clara Light Acacia	814 Acacia Foncé Acacia Oscura Dark Acacia	815 Zebrano Zebrano Zebrano	790 Graphite Grafito Graphite	791 Argent Plata Silver	

Tapizados
Cf. page 574
Ver pagina 574
See page 574

MODÈLES | VARIANTES | VERSIONS

MODÈLE / VARIANTES / VERSIONS	TYPE / TIPO / TYPE	DIMENSIONS / MEDIDAS / MEASUREMENTS	RÉFÉRENCE / REFERENCIA / CODE
	Modules / Módulos de / Moduls of:		19mm 25mm
	H.120 cm	100 x 70 cm 80 x 70 cm	807.214.--- 807.215.---
Individual terminal Individual terminal Single start unit	H.140 cm	100 x 70 cm 80 x 70 cm	807.204.--- 807.205.---
	H.120 cm	100 x 70 cm 80 x 70 cm	807.234.--- 807.235.---
	H.140 cm	100 x 70 cm 80 x 70 cm	807.224.--- 807.225.---
	H.120 cm	100 x 140 cm 80 x 140 cm	807.264.--- 807.265.---
Individual central Individual central Single add-on unit	H.140 cm	100 x 140 cm 80 x 140 cm	807.254.--- 807.255.---
	H.120 cm	100 x 140 cm 80 x 140 cm	807.284.--- 807.285.---
	H.140 cm	100 x 140 cm 80 x 140 cm	807.274.--- 807.275.---
	H.120 cm	100 x 140 cm 80 x 140 cm	807.284.--- 807.285.---
En vis à vis terminal Enfrentados terminal Face to face start unit	H.140 cm	100 x 140 cm 80 x 140 cm	807.274.--- 807.275.---
	H.120 cm	100 x 140 cm 80 x 140 cm	807.284.--- 807.285.---
	H.140 cm	100 x 140 cm 80 x 140 cm	807.274.--- 807.275.---
	H.120 cm	100 x 140 cm 80 x 140 cm	807.284.--- 807.285.---
En vis à vis central Enfrentados central Face to face add-on unit	H.140 cm	1400 x 70 + 100 cm 1400 x 70 + 80 cm	807.266.--- 807.267.---
	H.120 cm	1400 x 70 + 100 cm 1400 x 70 + 80 cm	807.256.--- 807.257.---
	H.140 cm	100 X 157 cm	807.408.--- 807.407.---
	H.120 cm	100 X 157 cm	807.404.--- 807.403.---
En vis à vis avec superviseur Enfrentados con supervisor Face to face with supervisor	H.140 cm	100 X 157 cm	807.408.--- 807.407.---
	H.120 cm	100 X 157 cm	807.404.--- 807.403.---

Marguerite
Margarita
Cluster

FINITIONS ACABADOS FINISHES

450	Blanc Blanco White	456	Gris Gris Grey	457	Hêtre Haya Beech	448	Graphite Grafito Graphite
458	Chêne Moyen Roble Maple	459	Poirier Peral Pear	492	Wengué Wengue Wengue	449	Argent Plata Silver
493	Acacia Clair Acacia Clara Light Acacia	494	Acacia Foncé Acacia Oscura Dark Acacia	495	Zebrano Zebrano Zebrano		



Cf. page 574
Ver pagina 574
See page 574

FINITIONS | ACABADOS | FINISHES

CLOISONS / MAMPARA / SCREEN | PLATEAUX / SOBRE / DESK TOP

002	Blanc Blanco White	010	Gris Gris Grey	011	Hêtre Haya Beech	012	Chêne Moyen Roble Maple	013	Poirier Peral Pear	019	Wengué Wengue Wengue
703	Acacia Clair Acacia Clara Light Acacia	704	Acacia Foncé Acacia Oscura Dark Acacia	705	Zebrano Zebrano Zebrano	004	Graphite Grafito Graphite	006	Argent Plata Silver		

Mélamine/ Tissu
Melamina / Tapizado
Melamine / Upholstered

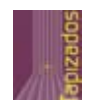

Cf. page 574
Ver pagina 574
See page 574

MODÈLES | VARIANTES | VERSIONS

MODÈLE / VARIANTES / VERSIONS	TYPE / TIPO / TYPE	DIMENSIONS / MEDIDAS / MEASUREMENTS	RÉFÉRENCE / REFERENCIA / CODE
	Modules / Módulos de / Moduls of:		25mm
	H.120 cm	100 x 70 cm 80 x 70 cm	807.214.--- 807.215.---
Individual terminal Individual terminal Single start unit	H.140 cm	100 x 70 cm 80 x 70 cm	807.204.--- 807.205.---
	H.120 cm	100 x 70 cm 80 x 70 cm	807.234.--- 807.235.---
	H.140 cm	100 x 70 cm 80 x 70 cm	807.224.--- 807.225.---
	H.120 cm	100 x 140 cm 80 x 140 cm	807.264.--- 807.265.---
Individual central Individual central Single add-on unit	H.140 cm	100 x 140 cm 80 x 140 cm	807.254.--- 807.255.---
	H.120 cm	100 x 140 cm 80 x 140 cm	807.284.--- 807.285.---
	H.140 cm	100 x 140 cm 80 x 140 cm	807.274.--- 807.275.---
	H.120 cm	100 x 140 cm 80 x 140 cm	807.284.--- 807.285.---
En vis à vis terminal Enfrentados terminal Face to face start unit	H.140 cm	100 x 140 cm 80 x 140 cm	807.274.--- 807.275.---
	H.120 cm	100 x 140 cm 80 x 140 cm	807.284.--- 807.285.---
	H.140 cm	100 x 140 cm 80 x 140 cm	807.274.--- 807.275.---
	H.120 cm	100 x 140 cm 80 x 140 cm	807.284.--- 807.285.---
En vis à vis central Enfrentados central Face to face add-on unit	H.140 cm	1400 x 70 + 100 cm 1400 x 70 + 80 cm	807.266.--- 807.267.---
	H.120 cm	1400 x 70 + 100 cm 1400 x 70 + 80 cm	807.256.--- 807.257.---
	H.140 cm	100 X 157 cm	807.408.--- 807.407.---
	H.120 cm	100 X 157 cm	807.404.--- 807.403.---
En vis à vis avec superviseur Enfrentados con supervisor Face to face with supervisor	H.140 cm	100 X 157 cm	807.408.--- 807.407.---
	H.120 cm	100 X 157 cm	807.404.--- 807.403.---

FINITIONS | ACABADOS | FINISHES

CLOISONS / MAMPARA / SCREEN | PLATEAUX / SOBRE / DESK TOP

Mét. Transparent / Mélamine Met. Transparente / Melamina Clear methacrylate / Melamine	413	Blanc Blanco White	414	Gris Gris Grey	415	Hêtre Haya Beech	416	Chêne Moyen Roble Maple	417	Poirier Peral Pear	418	Wengué Wengue Wengue
	626	Acacia Clair Acacia Clara Light Acacia	627	Acacia Foncé Acacia Oscura Dark Acacia	628	Zebrano Zebrano Zebrano	408	Graphite Grafito Graphite	409	Argent Plata Silver		

ROCK SYSTEMS

ROCK SYSTEMS est une gamme de cloisons modulaires qui permet de créer des espaces de travail dynamiques et confortables.

ROCK SYSTEMS es una serie de mamparas diseñadas para crear espacios de trabajo dinámicos. Con distintas formas y acabados se podrá aislar cualquier espacio manteniendo el estilo de las oficinas.

ROCK SYSTEMS is a furniture screen range. Designed with modular elements that can be combined to create an optimum, comfortable and visually appealing space.

ENSEMBLE
DE CLOISONS
DROITES

CONJUNTO
DE MAMPARAS
RECTAS

STRAIGHT
SCREENS
SET



CLOISONS
MONOPANNEAU

MAMPARAS RECTAS
MONO PANEL

SINGLE PANEL
STRAIGHT SCREENS

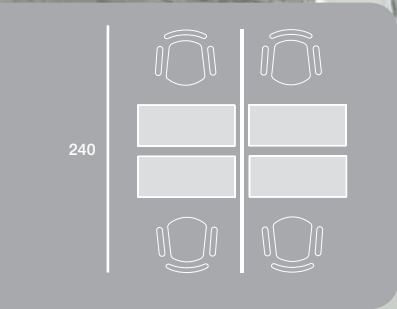

UNION CIRCULAIRE
ENTRE 3
CLOISONS

UNIÓN CIRCULAR
ENTRE 3
MAMPARAS

3 SCREENS
SET



CLOISONS
MULTI-PANNEAUX

MAMPARAS RECTAS
MULTIPANEL

MULTIPANEL
STRAIGHT SCREENS



Unions entre 2, 3 ou 4 cloisons.
Uniones de 2, 3 o 4 mamparas.
Joining fittings of 2, 3 or 4 screens.

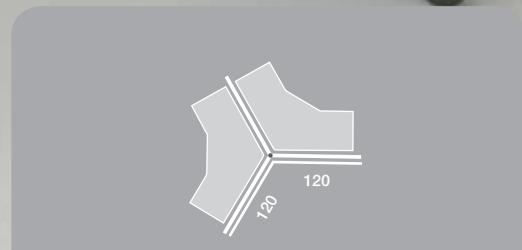
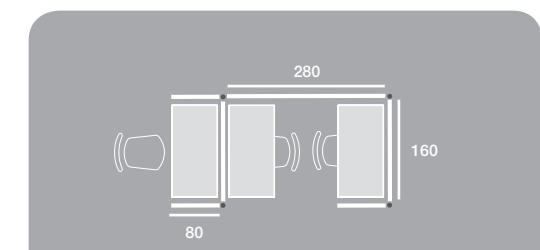

CLOISONS QUART
DE CERCLE

MAMPARAS
CURVADAS 90°

CURVED
SCREENS

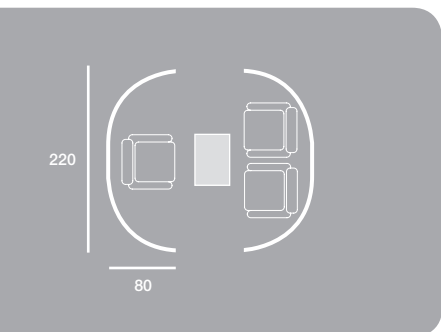

Cadí

En combinant les dimensions disponibles, vous pouvez toujours meubler votre local pour petit qu'il soit.

Combinando las medidas disponibles siempre se puede encontrar un modelo que se adapte a un local, por pequeño que sea.

By combining different measurements, customized furniture ensembles can be created to suit rooms of any size.

TABLE
RECTANGULAIRE

MESA
RECTANGULAR

RECTANGULAR
DESK



PLATEAUX / SOBRE / DESK TOP

Mélamine / Melamina / Melamine
Stratifié / Estratificado / Stratified 19 mm

Chant en ABS / Canto ABS / ABS edges

STRUCTURE / ESTRUCTURA / FRAME

Acier: 30 x 30 x 1,5 mm 
Acero:
Steel:

Périmétrale / Perimetral / Perimeter

FINITION STRUCTURE / ACABADO ESTRUCTURA / FRAME FINISH

Peinture époxy
Pintura epoxi
Epoxy paint

HAUTEUR / ALTURA / HEIGHT

72 mm

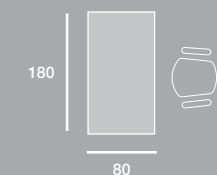

TABLE
TRAPÉZOÏDALE

MESA
TRAPEZOIDAL

TRAPEZOIDAL
DESK

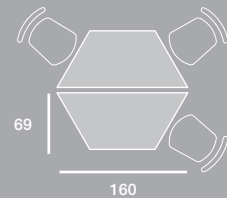
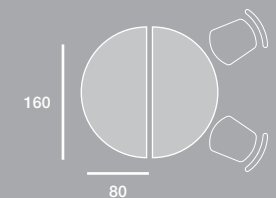

TABLE
DEMI-RONDE

MESA
SEMICIRCULAR



SEMICIRCULAR
DESK

La table trapézoïdale permet plusieurs compositions.
La mesa trapezoidal permite hacer múltiples composiciones.
With the trapezoidal desk many shapes are available.



MODÈLES | VARIANTES | VERSIONS

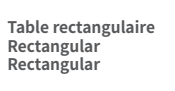

MODÈLE / VARIANTES / VERSIONS	DIMENSIONS / MEDIDAS / MEASUREMENTS	RÉFÉRENCE / REFERENCIA / CODE			
		■	■	■	■
 Table rectangulaire Rectangular	180 x 80 cm	48.001.-..	48.011.-..	48.021.-..	48.031.-..
	160 x 80 cm	48.002.-..	48.012.-..	48.022.-..	48.032.-..
	140 x 80 cm	48.003.-..	48.013.-..	48.023.-..	48.033.-..
	120 x 80 cm	48.004.-..	48.014.-..	48.024.-..	48.034.-..
	80 x 80 cm	48.005.-..	48.015.-..	48.025.-..	48.035.-..
 Table rectangulaire Rectangular	160 x 70 cm	48.007.-..	48.017.-..	48.027.-..	48.037.-..
	140 x 70 cm	48.008.-..	48.018.-..	48.028.-..	48.038.-..
	120 x 70 cm	48.009.-..	48.019.-..	48.029.-..	48.039.-..
	70 x 70 cm	48.006.-..	48.016.-..	48.026.-..	48.036.-..
	120 x 60 cm	48.104.-..	48.114.-..	48.124.-..	48.134.-..
 Table demi-ronde Semicircular	160 x 80 cm	48.040.-..	48.041.-..	48.042.-..	48.043.-..
	140 x 70 cm	48.044.-..	48.045.-..	48.046.-..	48.047.-..
 Table trapézoïdale Trapezoidal	160 x 69 cm	48.050.-..	48.051.-..	48.052.-..	48.053.-..
	140 x 61 cm	48.054.-..	48.055.-..	48.056.-..	48.057.-..
	120 x 52 cm	48.150.-..	48.151.-..	48.152.-..	48.153.-..

FINITIONS | ACABADOS | FINISHES

PLATEAUX / SOBRE / DESK TOP

053	Blanc Blanco White	054	Gris Gris Grey	055	Hêtre Haya Beech	061	Chêne Moyen Roble Maple	062	Poirier Peral Pear
116	Wengué Wengue Wengue	103	Acacia Clair Acacia Clara Light Acacia	104	Acacia Foncé Acacia Oscura Dark Acacia	105	Zebrano Zebrano Zebrano		



espace

Espace s'adapte à toutes les ambiances de travail, recherchant l'élégance des formes et la simplicité des finitions.

Son caractère polyvalent permet de créer différents espaces. Un programme pour collectivités et bureaux sous un même nom.

Espace se adapta a los espacios de trabajo actuales buscando la simplicidad de formas y acabados. Programa de colectividades y oficina bajo un mismo nombre.

ESPACE fits in every office style. Simple looking with a round pole leg. Its versatility will allow to provide different environments. Useful for any kind of corner or room.

PLATEAUX / SOBRES / DESK TOP

Mélamine / Melamina / Melamine
Stratifié / Estratificado / Stratified 25 mm

Chant en ABS / Canto ABS / ABS edges

STRUCTURE / ESTRUCTURA / FRAME

Acier: Ø 55 x 1,5 mm
Acero: Ø 55 x 1,5 mm
Steel: Ø 55 x 1,5 mm

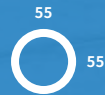

FINITION STRUCTURE / ACABADO ESTRUCTURA / FRAME FINISH

Peinture époxy
Pintura epoxi
Epoxy paint

HAUTEUR / ALTURA / HEIGHT

Fixe: 73 mm
Fija: 73 mm
Fixed: 73 mm
Réglable: 68 < 76 mm
Regulable: 68 < 76 mm
Adjustable: 68 < 76 mm

OPTION / OPCIÓN / OPTION

Voile de fond / Faldón / Modesty panel

TABLE
RECTANGULAIRE

MESA
RECTANGULAR

RECTANGULAR
DESK

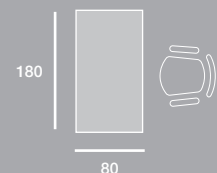

TABLE
RECTANGULAIRE
AVEC COINS
ARRONDIS

MESA
RECTANGULAR
CON CANTOS
REDONDEADOS

RECTANGULAR
DESK WITH
ROUNDED
EDGES



TABLE
DEMI-RONDE

MESA SEMI-
CIRCULAR CON
MESA RECTA

SEMICIRCULAR
DESK



TABLE
TRAPÉZOÏDALE +
DEMI-RONDE

MESA
TRAPEZOIDAL
CON MESA
SEMI-CIRCULAR

TRAPEZOIDAL
DESK

La table trapézoïdale permet plusieurs compositions.
La mesa trapezoidal permite hacer múltiples composiciones.
With the trapezoidal desk many shapes are available.

160

80

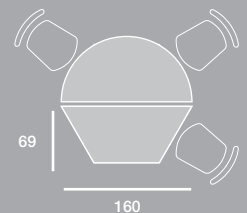
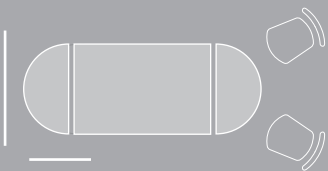

160

MODÈLES | VARIANTES | VERSIONS

HAUTEUR FIXE / FIJAS / FIXED HEIGHT

MODÈLE / VARIANTES / VERSIONS	DIMENSIONS / MEDIDAS / MEASUREMENTS	RÉFÉRENCE / REFERENCIA / CODE				
	180 x 80 cm 160 x 80 cm 140 x 80 cm 120 x 80 cm 80 x 80 cm	Coins droits Cantos rectos Square edges	Coins arrondis Cantos redondeados Round edges			
		371.301...-	371.501...-			
		371.302...-	371.502...-			
		371.303...-	371.503...-			
		371.304...- 371.305...-	371.504...- 371.505...-			
	180 x 70 cm 160 x 70 cm 140 x 70 cm 120 x 70 cm 80 x 70 cm	371.331...- 371.332...- 371.333...- 371.334...- 371.335...-	371.531...- 371.532...- 371.533...- 371.534...- 371.535...-			
		180 x 60 cm 160 x 60 cm 140 x 60 cm 120 x 60 cm 80 x 60 cm	371.371...- 371.372...- 371.373...- 371.374...- 371.375...-	371.571...- 371.572...- 371.573...- 371.574...- 371.575...-		
			160 x 80 cm 140 x 70 cm 120 x 60 cm	371.314...- 371.344...- 371.384...-	371.514...- 371.544...- 371.584...-	
				160 x 69,3 cm 140 x 60,6 cm 120 x 52 cm	371.310...- 371.340...- 371.380...-	371.510...- 371.540...- 371.580...-

RÉGLABLE EN HAUTEUR / REGULABLE EN ALTURA / ADJUSTABLE HEIGHT

MODÈLE / VARIANTES / VERSIONS	DIMENSIONS / MEDIDAS / MEASUREMENTS	RÉFÉRENCE / REFERENCIA / CODE				
	180 x 80 cm 160 x 80 cm 140 x 80 cm 120 x 80 cm 80 x 80 cm	Coins droits Cantos rectos Square edges	Coins arrondis Cantos redondeados Round edges			
		371.401...- 371.402...- 371.403...- 371.404...- 371.405...-	371.601...- 371.602...- 371.603...- 371.604...- 371.605...-			
		180 x 70 cm 160 x 70 cm 140 x 70 cm 120 x 70 cm 80 x 70 cm	371.431...- 371.432...- 371.433...- 371.434...- 371.435...-	371.631...- 371.632...- 371.633...- 371.634...- 371.635...-		
			180 x 60 cm 160 x 60 cm 140 x 60 cm 120 x 60 cm 80 x 60 cm	371.471...- 371.472...- 371.473...- 371.474...- 371.475...-	371.671...- 371.672...- 371.673...- 371.674...- 371.675...-	
				160 x 80 cm 140 x 70 cm 120 x 60 cm	371.414...- 371.444...- 371.484...-	371.614...- 371.644...- 371.684...-
	160 x 69,3 cm 140 x 60,6 cm 120 x 52 cm				371.410...- 371.440...- 371.480...-	371.610...- 371.640...- 371.680...-

FINITIONS | ACABADOS | FINISHES

STRUCTURE / ESTRUCTURA / FRAME | PLATEAUX / SOBRES / DESK TOP

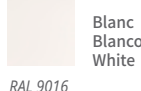
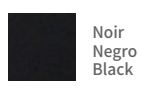
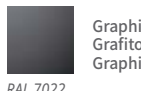
	060 Blanc Blanco White	064 Gris Gris Grey	065 Hêtre Haya Beech	066 Chêne Moyen Roble Maple	067 Poirier Peral Pear
	068 Wengué Wengue Wengue	706 Acacia Clair Acacia Clara Light Acacia	707 Acacia Foncé Acacia Oscura Dark Acacia	708 Zebrano Zebrano Zebrano	
	096 Blanc Blanco White	097 Gris Gris Grey	098 Hêtre Haya Beech	099 Chêne Moyen Roble Maple	100 Poirier Peral Pear
	101 Wengué Wengue Wengue	709 Acacia Clair Acacia Clara Light Acacia	710 Acacia Foncé Acacia Oscura Dark Acacia	711 Zebrano Zebrano Zebrano	
	102 Blanc Blanco White	153 Gris Gris Grey	154 Hêtre Haya Beech	155 Chêne Moyen Roble Maple	156 Poirier Peral Pear
	158 Wengué Wengue Wengue	712 Acacia Clair Acacia Clara Light Acacia	713 Acacia Foncé Acacia Oscura Dark Acacia	714 Zebrano Zebrano Zebrano	
	163 Blanc Blanco White	180 Gris Gris Grey	181 Hêtre Haya Beech	182 Chêne Moyen Roble Maple	183 Poirier Peral Pear
	184 Wengué Wengue Wengue	715 Acacia Clair Acacia Clara Light Acacia	716 Acacia Foncé Acacia Oscura Dark Acacia	717 Zebrano Zebrano Zebrano	

Net

Table polyvalente qui grâce à ses formes et à sa mobilité permet la création de multiples combinaisons.

Mesa polivalente de múltiples posibilidades, gracias a su movilidad y variedad de formas.

Multipurpose table thanks to its great variety of shapes.

TABLE
RECTANGULAIRE

MESA
RECTANGULAR

RECTANGULAR
DESK

PLATEAUX / SOBRE / DESK TOP

Mélamine / Melamina / Melamine: 25 mm / 30 mm
Stratifié / Estratificado / Stratified:

Chant en ABS / Canto ABS / ABS edges

STRUCTURE / ESTRUCTURA / FRAME

Aluminium
Aluminio
Aluminium



FINITION STRUCTURE / ACABADO ESTRUCTURA / FRAME FINISH

Peinture époxy
Pintura epoxi
Epoxy paint

HAUTEUR / ALTURA / HEIGHT

74 mm

OPTION / OPCIÓN / OPTION

Voile de fond / Faldón / Modesty panel

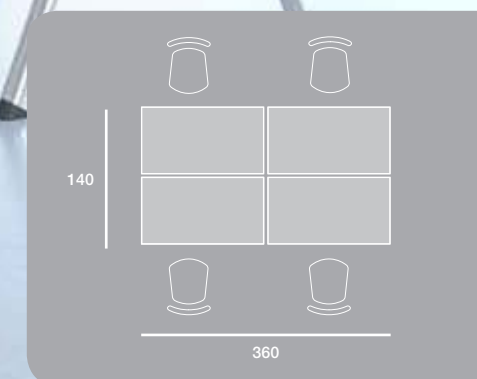



Elle peut facilement se ranger grâce à son plateau rabattable.
Se puede almacenar sin ocupar mucho espacio gracias a su sobre abatible.
Can be stored in a corner thanks to its foldable top.

La table avec quart de rond intégré nous permet créer plusieurs compositions.
La mesa con ángulo permite hacer varias composiciones.
Desk with angle allow multiple configurations.

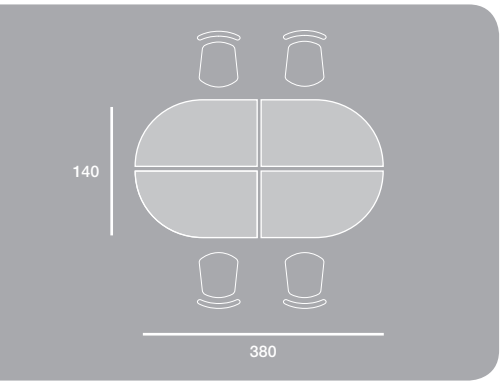

PLATEAU
AVEC ANGLE

MESA
CON ÁNGULO

DESK
WITH ANGLE

TABLE
DEMI-RONDE

MESA
SEMICIRCULAR

SEMICIRCULAR
DESK

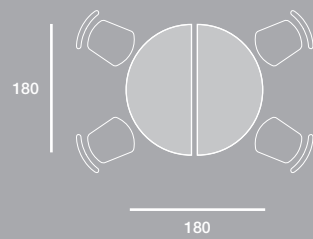



Roulettes équipées avec freins.
Las mesas disponen de ruedas con freno.
Wheels have brakes.

MODÈLES | VARIANTES | VERSIONS

MODÈLE / VARIANTES / VERSIONS	TYPE / TIPO / TYPE	DIMENSIONS / MEDIDAS / MEASUREMENTS	RÉFÉRENCE / REFERENCIA / CODE
	Démontées / Desmontadas / Disassembled	180 x 70 cm 150 x 70 cm 120 x 70 cm	551.002.--- 551.005.--- 551.008.---
Table rectangulaire Rectangular Rectangular	Semi montées / Semi montadas / Semi-assembled	180 x 70 cm 150 x 70 cm 120 x 70 cm	551.202.--- 551.205.--- 551.208.---
			À droite / Derecha / Right À gauche / Izquierda / Left
	Démontées / Desmontadas / Disassembled	190 x 70 cm	551.020.--- 551.021.---
Table avec angle Mesa con ángulo Desk with angle	Semi montées / Semi montadas / Semi-assembled	190 x 70 cm	551.220.--- 551.221.---
	Démontées / Desmontadas / Disassembled	180 x 90 cm	551.030.---
Table demi-ronde Semicircular Semicircular	Semi montées / Semi montadas / Semi-assembled	180 x 90 cm	551.230.---

FINITIONS | ACABADOS | FINISHES

STRUCTURE / ESTRUCTURA / FRAME | PLATEAUX / SOBRE / DESK TOP

	074	Blanc Blanco White	069	Gris Gris Grey	020	Graphite Grafito Graphite	070	Hêtre Haya Beech	071	Chêne Moyen Roble Maple
	072	Poirier Peral Pear	073	Wengué Wengue Wengue	730	Acacia Clair Acacia Clara Light Acacia	731	Acacia Foncé Acacia Oscura Dark Acacia	732	Zebrano Zebrano Zebrano
	082	Blanc Blanco White	083	Gris Gris Grey	321	Graphite Grafito Graphite	084	Hêtre Haya Beech	085	Chêne Moyen Roble Maple
	086	Poirier Peral Pear	087	Wengué Wengue Wengue	733	Acacia Clair Acacia Clara Light Acacia	734	Acacia Foncé Acacia Oscura Dark Acacia	735	Zebrano Zebrano Zebrano



Delta

Le banque d'accueil DELTA se démarque par ses lignes droites, de design atemporel. Elle propose 2 gammes: La Basique, plus simple et uniquement modulable en horizontal; et la gamme PLUS, avec illumination LED, formes variées et rehausse optionnelle.

El mostrador DELTA destaca por sus líneas rectas, un minimalismo que lo convierte en un diseño atemporal. Ofrece dos gamas: Basic, más sencilla y con crecimiento horizontal; y la gama Plus, con iluminación LED y altillo opcional.

DELTA counter has a timeless design thanks to its straight lines. Basic range is simple and with horizontal expansion. Plus range has LED lights and an optional upper counter top.

| DELTA PLUS

| DELTA PLUS

| DELTA PLUS

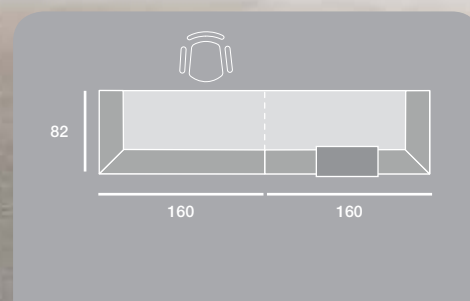

DELTA PLUS
AVEC MODULE
PMR

DELTA PLUS
CON ATENCIÓN
AL CLIENTE

DELTA PLUS
WITH DESK
HEIGHT COUNTER

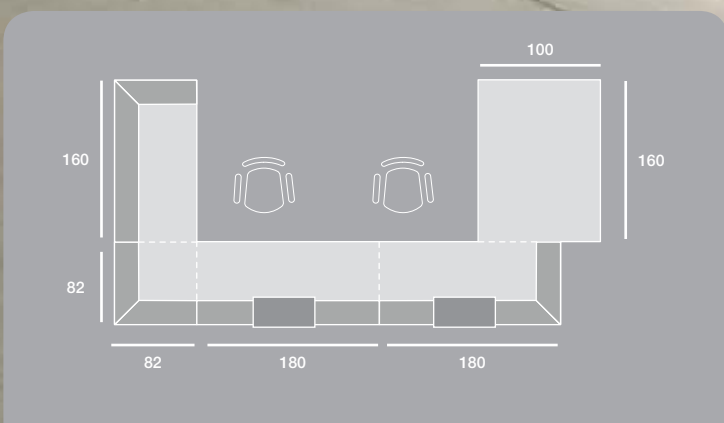

DELTA PLUS
AVEC SUPPORT
ÉCRAN

DELTA PLUS
CON SOPORTE
PARA PANTALLAS

DELTA PLUS
WITH MONITOR
HOLDER

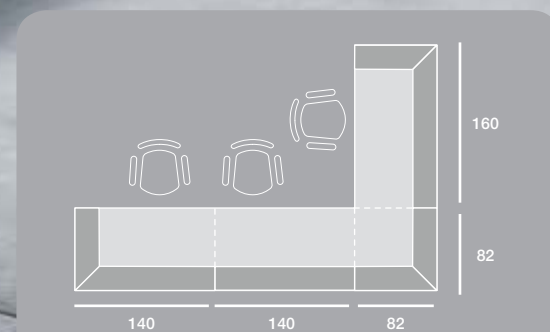

Deux options pour mettre en place l'écran.
Dos opciones distintas para colocar el monitor.
Two different ways to fix the computer screen.



DELTA
BASIC

DELTA
BASIC

DELTA
BASIC

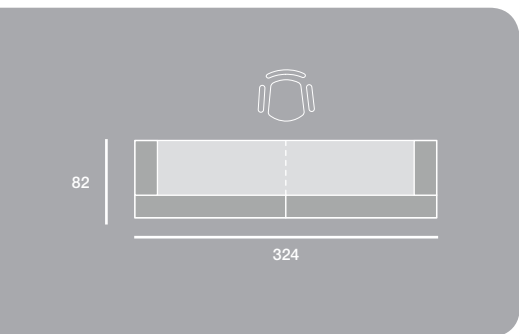

MODÈLES | VARIANTES | VERSIONS

DELTA PLUS - OPTION ÉCLAIRAGE / CON LUZ / WITH LIGHT

MODÈLE / VARIANTES / VERSIONS	TYPE / TIPO / TYPE	DIMENSIONS / MEDIDAS / MEASUREMENTS	RÉFÉRENCE / REFERENCIA / CODE	Option écran Opción pantalla PC screen option
	H. 110 cm	Droite / Derecha / Right 182,2 x 82,1 cm 162,2 x 82,1 cm 142,2 x 82,1 cm 102,2 x 82,1 cm 82,2 x 82,1 cm (90°)	622.212... 622.216... 622.220... 622.227... 622.224...	622.412... 622.416... 622.420... 622.427...
Terminal Terminal Individual	H. 110 cm	Gauche / Izquierda / Left 182,2 x 82,1 cm 162,2 x 82,1 cm 142,2 x 82,1 cm 102,2 x 82,1 cm 82,2 x 82,1 cm (90°)	622.214... 622.218... 622.222... 622.228... 622.226...	622.414... 622.418... 622.422... 622.428... 622.426...
	H. 110 cm	B 180 x 82,1 cm 160 x 82,1 cm 140 x 82,1 cm	622.230... 622.232... 622.234...	622.430... 622.432... 622.434...
Central Central Add-on	H. 110 cm	B2 Droite / Derecha / Right 82,2 x 82,1 cm	622.236...	
	H. 110 cm	B1 Gauche / Izquierda / Left 82,2 x 82,1 cm	622.237...	

DELTA PLUS - SANS ÉCLAIRAGE / SIN LUZ / WITHOUT LIGHT

MODÈLE / VARIANTES / VERSIONS	TYPE / TIPO / TYPE	DIMENSIONS / MEDIDAS / MEASUREMENTS	RÉFÉRENCE / REFERENCIA / CODE	Option écran Opción pantalla PC screen option
	H. 110 cm	Droite / Derecha / Right 182,2 x 82,1 cm 162,2 x 82,1 cm 142,2 x 82,1 cm 102,2 x 82,1 cm 82,2 x 82,1 cm (90°)	622.112... 622.116... 622.120... 622.127... 622.124...	622.312... 622.316... 622.320... 622.327... 622.327...
Terminal Terminal Individual	H. 110 cm	Gauche / Izquierda / Left 182,2 x 82,1 cm 162,2 x 82,1 cm 142,2 x 82,1 cm 102,2 x 82,1 cm 82,2 x 82,1 cm (90°)	622.114... 622.118... 622.122... 622.128... 622.126...	622.314... 622.318... 622.322... 622.328... 622.328...
	H. 110 cm	B 180 x 82,1 cm 160 x 82,1 cm 140 x 82,1 cm	622.130... 622.132... 622.134...	622.330... 622.332... 622.334...
Central Central Add-on	H. 110 cm	B2 Droite / Derecha / Right 82,2 x 82,1 cm (90°)	622.136...	
	H. 110 cm	B1 Gauche / Izquierda / Left 82,2 x 82,1 cm (90°)	622.137...	

EXEMPLE | EJEMPLOS | EXAMPLES

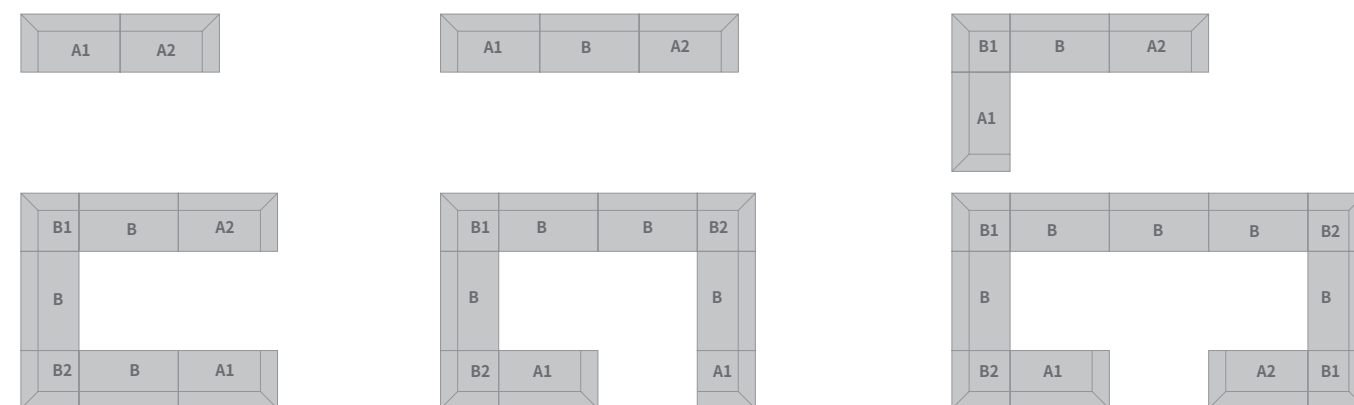

MODÈLES | VARIANTES | VERSIONS

DELTA PLUS - OPTION ÉCLAIRAGE / CON LUZ / WITH LIGHT

MODÈLE / VARIANTES / VERSIONS	TYPE / TIPO / TYPE	DIMENSIONS / MEDIDAS / MEASUREMENTS	RÉFÉRENCE / REFERENCIA / CODE	Option écran Opción pantalla PC screen option
	H. 110 cm	184,4 x 82,1 cm 164,4 x 82,1 cm 144,4 x 82,1 cm	622.202... 622.204... 622.206...	622.402... 622.404... 622.406...
Individuel Individuel Individuel	H. 110 cm	184,4 x 82,1 cm 164,4 x 82,1 cm 144,4 x 82,1 cm	622.102... 622.104... 622.106...	622.302... 622.304... 622.306...

DELTA PLUS - SANS ÉCLAIRAGE / SIN LUZ / WITHOUT LIGHT

MODÈLE / VARIANTES / VERSIONS	TYPE / TIPO / TYPE	DIMENSIONS / MEDIDAS / MEASUREMENTS	RÉFÉRENCE / REFERENCIA / CODE	Option écran Opción pantalla PC screen option
	H. 110 cm	184,4 x 82,1 cm 164,4 x 82,1 cm 144,4 x 82,1 cm	622.102... 622.104... 622.106...	622.302... 622.304... 622.306...

COMPLÉMENTS | COMPLEMENTOS | COMPLEMENTS

MODÈLE / VARIANTES / VERSIONS	DIMENSIONS / MEDIDAS / MEASUREMENTS	RÉFÉRENCE / REFERENCIA / CODE	Option éclairage Con luz With light
	80 x 36 cm	622.170... *	624.170... *
Rehausse Attilio Upper counter top	120 x 36 cm	622.172... *	624.172... *

ES	DE	FR	US	UK
446.991.000	446.992.000	446.995.000		

Éclairage
Latiguillo para mostrador con luz o attilio con luz
Light

FINITIONS | ACABADOS | FINISHES

204	Graphite Grafito Graphite	051	Argent Plata Silver	053	Blanc Blanco White	197	Gris Gris Grey	198	Hêtre Haya Beech	199	Chêne Moyen Roble Maple
200	Poirier Peral Pear	202	Wengué Wengue Wengue	103	Acacia Clair Acacia Clara Light Acacia	104	Acacia Foncé Acacia Oscura Dark Acacia	105	Zebrano Zebrano Zebrano		

* Cf. page 574
Ver pagina 574
See page 574

MODÈLES | VARIANTES | VERSIONS

DELTA BASIC

MODÈLE / VARIANTES / VERSIONS	TYPE / TIPO / TYPE	DIMENSIONS / MEDIDAS / MEASUREMENTS	RÉFÉRENCE / REFERENCIA / CODE
	H. 110 cm	184,4 x 82,1 cm 164,4 x 82,1 cm 144,4 x 82,1 cm	621.102--- 621.104--- 621.106---
Terminal Terminal Individual			
	H. 110 cm	364,4 x 82,1 cm 324,4 x 82,1 cm 284,4 x 82,1 cm	621.112--- 621.114--- 621.116---
Double Doble Double			
	H. 110 cm	C 180 x 82,1 cm 160 x 82,1 cm 140 x 82,1 cm	621.122--- 621.124--- 621.126---
Central Central Add-on			

EXEMPLE | EJEMPLOS | EXAMPLES



FINITIONS | ACABADOS | FINISHES

204 Graphite Grafito Graphite	051 Argent Plata Silver	053 Blanc Blanco White	197 Gris Gris Grey	198 Hêtre Haya Beech	199 Chêne Moyen Roble Maple
200 Poirier Peral Pear	202 Wengué Wengue Wengue	103 Acacia Clair Acacia Clara Light Acacia	104 Acacia Foncé Acacia Oscura Dark Acacia	105 Zebrano Zebrano Zebrano	



ROCK RECEPTION

ROCK RECEPTION est une série de banques d'accueil modulaires qui offre de multiples combinaisons pour obtenir un ensemble visuellement attrayant. Vous pouvez créer des banques d'accueil sur mesure, pour refléter la personnalité de votre entreprise.

ROCK RECEPTION es un completo programa de mostradores modulares que se combinan a voluntad para diseñar un conjunto optimizado, estético y comfortable. Se pueden crear recepciones a medida.

ROCK RECEPTION is a complete range of modular reception counters designed with elements that can be combined to create an optimum, comfortable and visually appealing reception. It is important to customize a reception area to reflect the unique personality of a company or organisation.

BANQUES
D'ACCUEIL
MULTIPANNEAUX

MOSTRADORES
MULTIPANEL

MULTI PANEL
COUNTER

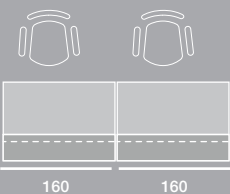

BUREAU D'ACCUEIL
POUR PERSONNES À
MOBILITÉ RÉDUITE

MESA ATENCIÓN
AL CLIENTE

HANDICAPPED
DESK



Disponibile en angle 45° ou droit.
Disponibile en ángulo o mesa recta.
Straight or curved shape available.

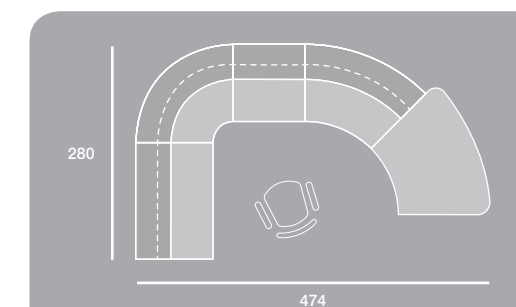
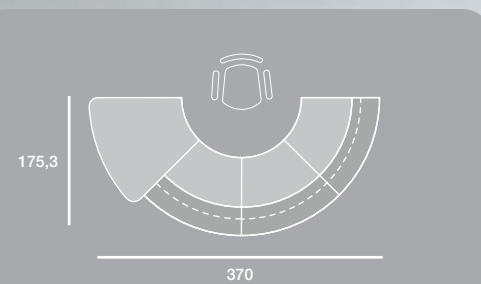



REHAUSSE FIXE
OU RÉGLABLE
EN HAUTEUR

MOSTRADOR FIJO
O REGULABLE
EN ALTURA

FIXED OR HEIGHT
ADJUSTABLE
COUNTER

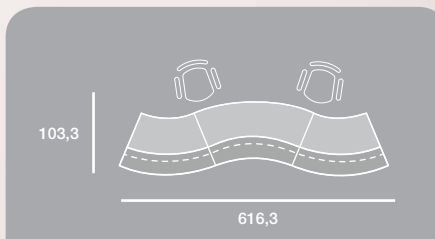

BANQUES D'ACCUEIL
UN SEUL PANNEAU

MOSTRADORES
UNIPANEL

SINGLE
PANEL COUNTER

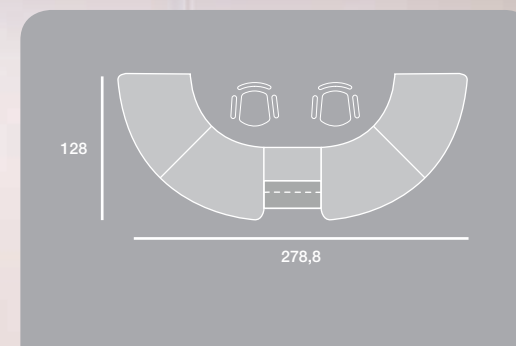

MODÈLES | VARIANTES | VERSIONS

UN SEUL PANNEAU - ROCK 3 / UNIPANEL - ROCK 3 / SINGLE PANEL - ROCK 3

MODÈLE / VARIANTES / VERSIONS	TYPE / TIPO / TYPE	DIMENSIONS / MEDIDAS / MEASUREMENTS	RÉFÉRENCE / REFERENCIA / CODE
	Prof./Depth 60 cm	200,6 x 100 x 106,9 cm	433.144.-.-
	Prof./Depth 60 cm	318,8 x 99,4 x 106,9 cm	433.145.-.-
	Prof./Depth 60 cm	278,8 x 120 x 106,9 cm	433.146.-.-
	Prof./Depth 60 cm	299,4 x 194,7 x 106,9 cm	433.147.-.-
	Prof./Depth 60 cm	299,4 x 175,5 x 106,9 cm	433.148.-.-
	Prof./Depth 60 cm	296,4 x 175,5 x 106,9 cm	433.149.-.-
	Prof./Depth 60 cm	296,4 x 195,2 x 106,9 cm	433.150.-.-
	Prof./Depth 60 cm	350,7 x 175,5 x 106,9 cm	433.151.-.-

MODÈLE / VARIANTES / VERSIONS	TYPE / TIPO / TYPE	DIMENSIONS / MEDIDAS / MEASUREMENTS	RÉFÉRENCE / REFERENCIA / CODE
	Prof./Depth 60 cm	375,4 x 103,3 x 106,9 cm	433.154.-.-
	Prof./Depth 60 cm	198,8 x 99,4 x 106,9 cm	433.141.-.-
	Prof./Depth 60 cm	198,8 x 169,6 x 106,9 cm	433.140.-.-
	Prof./Depth 60 cm	616,3 x 103,3 x 106,9 cm	433.155.-.-

FINITIONS | ACABADOS | FINISHES

Rehausse en mélamine
Sobre mostrador en melamina
Melamine counter top









053	Blanc Blanco White	054	Gris Gris Grey	055	Hêtre Haya Beech	061	Chêne Moyen Roble Maple	062	Poirier Peral Pear	063	Wengué Wengue Wengue
103	Acacia Clair Acacia Clara Light Acacia	104	Acacia Foncé Acacia Oscura Dark Acacia	105	Zebrano Zebrano Zebrano						

Rehausse en verre
Sobre mostrador en vidrio
Glass counter top

453	Blanc Blanco White	454	Gris Gris Grey	455	Hêtre Haya Beech	461	Chêne Moyen Roble Maple	462	Poirier Peral Pear	463	Wengué Wengue Wengue
793	Acacia Clair Acacia Clara Light Acacia	794	Acacia Foncé Acacia Oscura Dark Acacia	795	Zebrano Zebrano Zebrano						

MODÈLES | VARIANTES | VERSIONS

MULTI PANNEAUX - ROCK 3 / MULTIPANEL - ROCK 3 / MULTI PANEL - ROCK 3

MODÈLE / VARIANTES / VERSIONS	TYPE / TIPO / TYPE	DIMENSIONS / MEDIDAS / MEASUREMENTS	RÉFÉRENCE / REFERENCIA / CODE
	Prof./Depth 60 cm	200,6 x 100 x 106,9 cm	433.344.-.-
	Prof./Depth 60 cm	318,8 x 99,4 x 106,9 cm	433.345.-.-
	Prof./Depth 60 cm	278,8 x 120 x 106,9 cm	433.346.-.-
	Prof./Depth 60 cm	299,4 x 194,7 x 106,9 cm	433.347.-.-
	Prof./Depth 60 cm	299,4 x 175,5 x 106,9 cm	433.348.-.-
	Prof./Depth 60 cm	296,4 x 175,5 x 106,9 cm	433.349.-.-
	Prof./Depth 60 cm	296,4 x 195,2 x 106,9 cm	433.350.-.-
	Prof./Depth 60 cm	350,7 x 175,5 x 106,9 cm	433.351.-.-

MODÈLE / VARIANTES / VERSIONS	TYPE / TIPO / TYPE	DIMENSIONS / MEDIDAS / MEASUREMENTS	RÉFÉRENCE / REFERENCIA / CODE
	Prof./Depth 60 cm	375,4 x 103,3 x 106,9 cm	433.354.-.-
	Prof./Depth 60 cm	198,8 x 99,4 x 106,9 cm	433.341.-.-
	Prof./Depth 60 cm	198,8 x 169,6 x 106,9 cm	433.340.-.-
	Prof./Depth 60 cm	616,3 x 103,3 x 106,9 cm	433.355.-.-

FINITIONS | ACABADOS | FINISHES

Rehausse en mélamine Sobre mostrador en melamina Melamine counter top	053	Blanc Blanco White	054	Gris Gris Grey	055	Hêtre Haya Beech	061	Chêne Moyen Roble Maple	062	Poirier Peral Pear	063	Wengué Wengue
	103	Acacia Clair Acacia Clara Light Acacia	104	Acacia Foncé Acacia Oscura Dark Acacia	105	Zebrano Zebrano Zebrano						
Rehausse en verre Sobre mostrador en vidrio Glass counter top	453	Blanc Blanco White	454	Gris Gris Grey	455	Hêtre Haya Beech	461	Chêne Moyen Roble Maple	462	Poirier Peral Pear	463	Wengué Wengue
	793	Acacia Clair Acacia Clara Light Acacia	794	Acacia Foncé Acacia Oscura Dark Acacia	795	Zebrano Zebrano Zebrano						

MODÈLES | VARIANTES | VERSIONS

UN SEUL PANNEAU - ROCK 4 / UNIPANEL - ROCK 4 / SINGLE PANEL - ROCK 4

MODÈLE / VARIANTES / VERSIONS	TYPE / TIPO / TYPE	DIMENSIONS / MEDIDAS / MEASUREMENTS	RÉFÉRENCE / REFERENCIA / CODE
	Prof./Depth 60 cm	200,6 x 100 x 106,9 cm	443.144.-.-
	Prof./Depth 60 cm	318,8 x 99,4 x 106,9 cm	443.145.-.-
	Prof./Depth 60 cm	278,8 x 120 x 106,9 cm	443.146.-.-
	Prof./Depth 60 cm	299,4 x 194,7 x 106,9 cm	443.147.-.-
	Prof./Depth 60 cm	299,4 x 175,5 x 106,9 cm	443.148.-.-
	Prof./Depth 60 cm	296,4 x 175,5 x 106,9 cm	443.149.-.-
	Prof./Depth 60 cm	296,4 x 195,2 x 106,9 cm	443.150.-.-
	Prof./Depth 60 cm	350,7 x 175,5 x 106,9 cm	443.151.-.-

MODÈLE / VARIANTES / VERSIONS	TYPE / TIPO / TYPE	DIMENSIONS / MEDIDAS / MEASUREMENTS	RÉFÉRENCE / REFERENCIA / CODE
	Prof./Depth 60 cm	375,4 x 103,3 x 106,9 cm	443.154.-.-
	Prof./Depth 60 cm	616,3 x 103,3 x 106,9 cm	443.155.-.-

FINITIONS | ACABADOS | FINISHES



LATÉRAL / LATERAL / FRAME

Rehausse en mélamine Sobre mostrador en melamina Melamine counter top		Argent / Argent Plata / Plata Silver / Silver	060 Blanc Blanco White	064 Gris Gris Grey	065 Hêtre Haya Beech	066 Chêne Moyen Roble Maple	
		Blanc / Blanc Blanco / Blanco White / White	067 Poirier Peral Pear	068 Wengué Wengue Wengue	706 Acacia Clair Acacia Clara Light Acacia	707 Acacia Foncé Acacia Oscura Dark Acacia	708 Zebano Zebano Zebano
		Blanc / Blanc Blanco / Blanco White / White	096 Blanc Blanco White				
Rehausse en verre Sobre mostrador en vidrio Glass counter top		Argent / Argent Plata / Plata Silver / Silver	460 Blanc Blanco White	464 Gris Gris Grey	465 Hêtre Haya Beech	466 Chêne Moyen Roble Maple	
		Blanc / Blanc Blanco / Blanco White / White	467 Poirier Peral Pear	468 Wengué Wengue Wengue	805 Acacia Clair Acacia Clara Light Acacia	806 Acacia Foncé Acacia Oscura Dark Acacia	807 Zebano Zebano Zebano
		Blanc / Blanc Blanco / Blanco White / White	496 Blanc Blanco White				

MODÈLES | VARIANTES | VERSIONS

MULTI PANNEAUX - ROCK 4 / MULTIPANEL - ROCK 4 / MULTI PANEL - ROCK 4

MODÈLE / VARIANTES / VERSIONS	TYPE / TIPO / TYPE	DIMENSIONS / MEDIDAS / MEASUREMENTS	RÉFÉRENCE / REFERENCIA / CODE
	Prof./Depth 60 cm	200,6 x 100 x 106,9 cm	443.344.-.-
	Prof./Depth 60 cm	318,8 x 99,4 x 106,9 cm	443.345.-.-
	Prof./Depth 60 cm	278,8 x 120 x 106,9 cm	443.346.-.-
	Prof./Depth 60 cm	299,4 x 194,7 x 106,9 cm	443.347.-.-
	Prof./Depth 60 cm	299,4 x 175,5 x 106,9 cm	443.348.-.-
	Prof./Depth 60 cm	296,4 x 175,5 x 106,9 cm	443.349.-.-
	Prof./Depth 60 cm	296,4 x 195,2 x 106,9 cm	443.350.-.-
	Prof./Depth 60 cm	350,7 x 175,5 x 106,9 cm	443.351.-.-

MODÈLE / VARIANTES / VERSIONS	TYPE / TIPO / TYPE	DIMENSIONS / MEDIDAS / MEASUREMENTS	RÉFÉRENCE / REFERENCIA / CODE
	Prof./Depth 60 cm	375,4 x 103,3 x 106,9 cm	443.354.-.-
	Prof./Depth 60 cm	616,3 x 103,3 x 106,9 cm	443.355.-.-

FINITIONS | ACABADOS | FINISHES

LATÉRAL / LATERAL / FRAME

Rehausse en mélamine Sobre mostrador en melamina Melamine counter top	Rehausse en verre Sobre mostrador en vidrio Glass counter top
<p>Argent / Argent Plata / Plata Silver / Silver</p> <p>Blanc / Blanc Blanco / Blanco White / White</p>	<p>Argent / Argent Plata / Plata Silver / Silver</p> <p>Blanc / Blanc Blanco / Blanco White / White</p>
<p>060 Blanc Blanco White</p> <p>067 Poirier Peral Pear</p> <p>096 Blanc Blanco White</p>	<p>060 Blanc Blanco White</p> <p>067 Poirier Peral Pear</p> <p>096 Blanc Blanco White</p>
<p>064 Gris Gris Grey</p> <p>068 Wengué Wengue</p>	<p>064 Gris Gris Grey</p> <p>068 Wengué Wengue</p>
<p>065 Hêtre Haya Beech</p> <p>076 Acacia Clair Acacia Clara Light Acacia</p>	<p>065 Hêtre Haya Beech</p> <p>076 Acacia Clair Acacia Clara Light Acacia</p>
<p>066 Chêne Moyen Roble Maple</p> <p>070 Acacia Foncé Acacia Oscura Dark Acacia</p> <p>077 Acacia Foncé Acacia Oscura Dark Acacia</p> <p>078 Zebrano Zebrano</p>	<p>066 Chêne Moyen Roble Maple</p> <p>070 Acacia Foncé Acacia Oscura Dark Acacia</p> <p>077 Acacia Foncé Acacia Oscura Dark Acacia</p> <p>078 Zebrano Zebrano</p>
<p>460 Blanc Blanco White</p> <p>467 Poirier Peral Pear</p> <p>496 Blanc Blanco White</p>	<p>460 Blanc Blanco White</p> <p>467 Poirier Peral Pear</p> <p>496 Blanc Blanco White</p>
<p>464 Gris Gris Grey</p> <p>468 Wengué Wengue</p>	<p>464 Gris Gris Grey</p> <p>468 Wengué Wengue</p>
<p>465 Hêtre Haya Beech</p> <p>805 Acacia Clair Acacia Clara Light Acacia</p>	<p>465 Hêtre Haya Beech</p> <p>805 Acacia Clair Acacia Clara Light Acacia</p>
<p>466 Chêne Moyen Roble Maple</p> <p>806 Acacia Foncé Acacia Oscura Dark Acacia</p> <p>807 Zebrano Zebrano</p>	<p>466 Chêne Moyen Roble Maple</p> <p>806 Acacia Foncé Acacia Oscura Dark Acacia</p> <p>807 Zebrano Zebrano</p>

OH Systems

Ordre et rangement définiront votre nouvel espace de travail. Grâce à sa grande variété de modèles et à ses multiples combinaisons OH Systems trouve sa place dans tous les bureaux.

Sistema modular de armarios. Orden y archivo definen el nuevo espacio de trabajo. OH Systems se adapta a cualquier oficina gracias a la gran variedad de modelos y a las múltiples combinaciones.

Tidiness and a good filing organization will improve the working space. A huge variety of functional types with Oh Systems drillings can match in any office.

ARMOIRES
PUSH OPEN

ARMARIOS
PUSH OPEN

PUSH OPEN
CABINETS

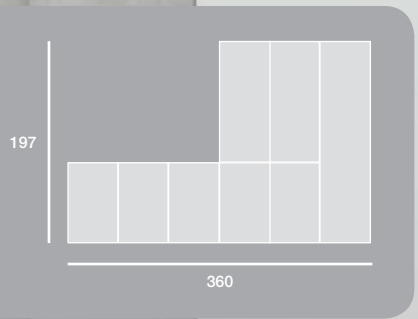



ARMOIRES
OUVERTES

ARMARIOS
HUECO

SHELVES
CABINETS

La cremallère des armoires OH Systems permet de placer les étagères et d'autres accessoires tout les 32 mm.

El sistema OH Systems permite colocar estantes y otros complementos cada 32 mm.

OH Systems drilling pattern permit to hang shelves every 32 mm.

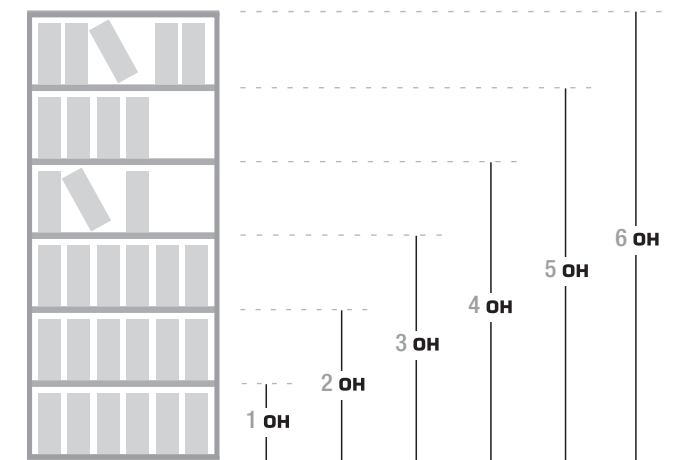
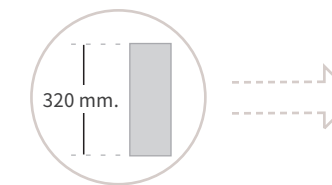

Option étagère fixe.
Opción estante fijo.
Fixed shelf.



Option étagère normale.
Opción estante móvil.
Normal shelf.

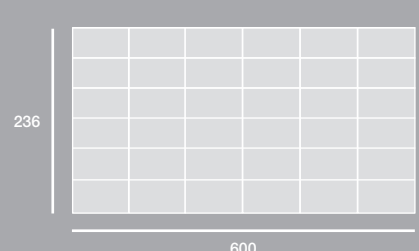

ARMOIRES
OUVERTES - PORTES

ARMARIOS
HUECO - PUERTAS

CABINET WITH
SHELVES AND DOORS

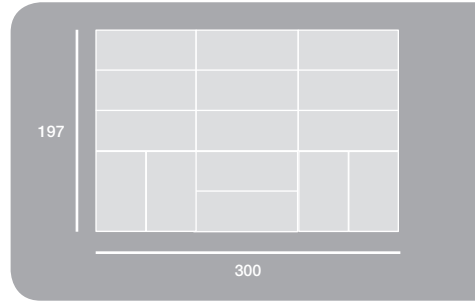



PORTES
EN VERRE

PUERTAS
DE VIDRIO

GLASS
DOORS



Détail poignées
Detalle tiradores
Handles detail



Portes push open
Puertas push open
Push open doors

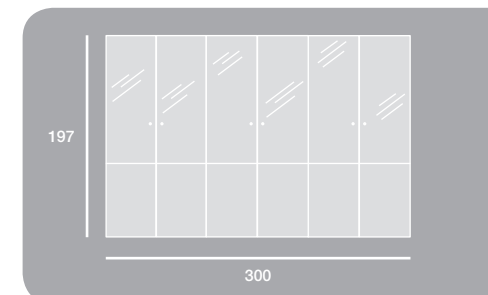



ARMOIRES
PORTES
BATTANTES

ARMARIOS
CON
PUERTAS

CABINETS
WITH
DOORS

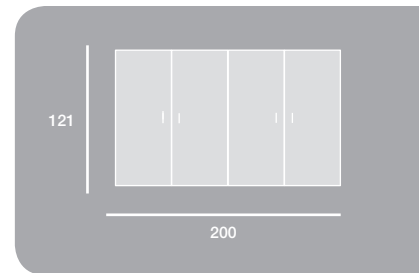

DOSSIERS
SUSPENDUS

ARCHIVOS

FILES

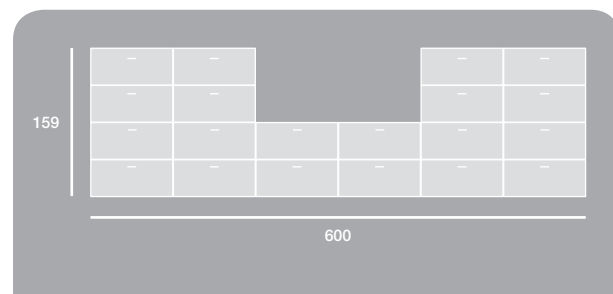

| CAISSON
| MÉLAMINE

| CAJONERA
| MELAMINA

| MELAMINE
| PEDESTAL



Deux types de poignées disponibles.
Tirador disponible en dos modelos.
Two types of handles available.

| CAISSON PORTEUR
| CAJONERA SOPORTANTE
| FIXED PEDESTAL

L'intérieur du tiroir peut être en mélamine ou en métal.
Pueden ser con cajón interior de melamina o de metal.
Melamine or metal slide for drawers.



| CAISSON À ROULETTES
| CAJONERA CON RUEDAS
| MOBILE PEDESTALS

Roulettes visibles ou non visibles.
Las ruedas puedan ser vistas u ocultas.
Available with hidden wheels.



| CRÉDENCE MÉLAMINÉE
| CREDENCIA MELAMINA
| MELAMINE CREDENZA

Espace pour UC + porte coulissante + tiroirs.
Con hueco para CPU + puerta corredera + cajones.
With CPU gap + sliding door + drawers.









| ACCESSOIRES CAISSONS
| ACCESORIOS PARA CUBETAS
| PEDESTAL ACCESSORIES





MODÈLES | VARIANTES | VERSIONS

ARMOIRES / ARMARIOS / CABINETS

ÉTAGÈRES INCLUSES / ESTANTES INCLUIDOS / INCLUDED SHELVES

MODÈLE / VARIANTES / VERSIONS	TYPE / TIPO / TYPE	H.		RÉFÉRENCE / REFERENCIA / CODE	
 <p>Armoire ouverte avec étagères Armario hueco Shelves cabinet</p>	Prof./ Depth. 45 cm	236 cm	236 cm	L. 100 cm	L. 80 cm
		197 cm	197 cm	364.021.-..	364.037.-..
		159 cm	159 cm	364.023.-..	364.039.-..
		121 cm	121 cm	364.025.-..	364.041.-..
		82,5 cm	82,5 cm	364.027.-..	364.043.-..
		73 cm	73 cm	364.029.-..	364.045.-..
		43,5 cm	43,5 cm	365.749.-..	365.751.-..
365.031.-..	365.047.-..				
 <p>Armoire portes battantes Armario con puertas batientes Hinged doors cabinet</p>	Prof./ Depth. 45 cm	236 cm	236 cm	364.103.-..	364.133.-..
		197 cm	197 cm	364.107.-..	364.137.-..
		159 cm	159 cm	364.111.-..	364.141.-..
		121 cm	121 cm	364.115.-..	364.145.-..
		82,5 cm	82,5 cm	364.119.-..	364.149.-..
		73 cm	73 cm	365.761.-..	365.765.-..
		43,5 cm	43,5 cm	365.123.-..	365.153.-..
 <p>Armoire portes push-open Armario push open Push open door cabinet</p>	Prof./ Depth. 45 cm	236 cm	236 cm	363.103.-..	363.133.-..
		197 cm	197 cm	363.107.-..	363.137.-..
		159 cm	159 cm	363.111.-..	363.141.-..
		121 cm	121 cm	363.115.-..	363.145.-..
		82,5 cm	82,5 cm	363.119.-..	363.149.-..
		73 cm	73 cm	367.761.-..	367.765.-..
		43,5 cm	43,5 cm	367.123.-..	367.153.-..
 <p>Armoire portes coulissantes Puertas correderas Sliding doors cabinet</p>	Prof./ Depth. 45 cm	121 cm		364.259.-..	
		82,5 cm		364.261.-..	
		43,5 cm		365.263.-..	
 <p>Armoire à rideaux Puertas persiana Tambour doors cabinet</p>	Prof./ Depth. 45 cm	197 cm		364.687.-..	
		159 cm		364.689.-..	
		121 cm		364.691.-..	
		82,5 cm		364.693.-..	
		73 cm		365.773.-..	
365.695.-..					
 <p>Penderie Ropero Wardrobe</p>	Prof./ Depth. 45 cm	197 cm		365.729.-..	
		159 cm		365.731.-..	

MODÈLE / VARIANTES / VERSIONS	TYPE / TIPO / TYPE	H.	RÉFÉRENCE / REFERENCIA / CODE	
 <p>Armoire DS Archivo File cabinet</p>	Prof./ Depth. 45 cm	159 cm	L. 100 cm	L. 80 cm
		121 cm	365.283.-..	365.291.-..
		82,5 cm	365.285.-..	365.293.-..
365.287.-..	365.295.-..			
 <p>Armoire ouverte - portes Hueco - puertas Shelves with low doors</p>	Prof./ Depth. 45 cm	236 cm	364.519.-..	364.541.-..
		197 cm	364.523.-..	364.545.-..
		159 cm	364.527.-..	364.549.-..
 <p>Armoire ouverte - DS Hueco - archivo Shelves with low files</p>	Prof./ Depth. 45 cm	197 cm	364.643.-..	364.655.-..
		159 cm	364.645.-..	364.657.-..
 <p>Armoire ouverte - portes push open Hueco - puertas push open Shelves with low push open doors</p>	Prof./ Depth. 45 cm	236 cm	363.519.-..	363.541.-..
		197 cm	363.523.-..	363.545.-..
		159 cm	363.527.-..	363.549.-..

FINITIONS | ACABADOS | FINISHES

DESSOUS, JOUES ET FOND
BAJO, LATERALES Y TRASERA
BOTTOM, SIDE AND BACK PANELS



TOP ET ÉTAGÈRES
TAPA Y ESTANTE
TOP AND DIVIDER SHELF

Argent Plata Silver	051	Argent Plata Silver	075	Blanc Blanco White	054	Gris Gris Grey	055	Hêtre Haya Beech	061	Chêne Moyen Roble Maple	062	Poirier Peral Pear
	116	Wengué Wengue Wengue	694	Acacia Clair Acacia Clara Light Acacia	695	Acacia Foncé Acacia Oscura Dark Acacia	696	Zebrano Zebrano Zebrano	125	Graphite 25 Grafito 25 Graphite 25		
Monochrome Monocolor Single-colour	053	Blanc Blanco White	197	Gris Gris Grey	198	Hêtre Haya Beech	199	Chêne Moyen Roble Maple	200	Poirier Peral Pear		
	202	Wengué Wengue Wengue	103	Acacia Clair Acacia Clara Light Acacia	104	Acacia Foncé Acacia Oscura Dark Acacia	105	Zebrano Zebrano Zebrano	204	Graphite 25 Grafito 25 Graphite 25		

MODÈLES | VARIANTES | VERSIONS

ARMOIRES VERRE / ARMARIOS VIDRIO / GLASS DOORS

ÉTAGÈRES INCLUSES / ESTANTES INCLUIDOS / INCLUDED SHELVES



MODÈLE / VARIANTES / VERSIONS	TYPE / TIPO / TYPE	H.	RÉFÉRENCE / REFERENCIA / CODE
	Prof./ Depth. 45 cm	197 cm 159 cm 121 cm 82,5 cm	L.100 cm 364.207.--- 364.209.--- 364.211.--- 364.213.---
Armoire portes en verre Armario con puertas vidrio Glass doors cabinet			
	Prof./ Depth. 45 cm	236 cm 197 cm 159 cm	364.595.--- 364.597.--- 364.599.---
Armoire ouverte - portes en verre Hueco - puertas vidrio Shelves with low glass doors			

FINITIONS | ACABADOS | FINISHES

PORTES EN VERRE | CORPS ARMOIRE

PUERTAS EN VIDRIO | ARMazón LIBRERÍA

GLASS DOORS | FRAME

	TYPE / TIPO / TYPE A						TYPE / TIPO / TYPE B					
	601 Blanc Blanco White	602 Gris Gris Grey	603 Hêtre Haya Beech	604 Chêne Moyen Roble Maple	605 Poirier Peral Pear	600 Argent Plata Silver	606 Wengué Wengue	439 Acacia Clair Acacia Clara Light Acacia	442 Acacia Foncé Acacia Oscura Dark Acacia	445 Zebrano Zebrano Zebrano	607 Graphite 25 Grafito 25 Graphite 25	
	613 Blanc Blanco White	614 Gris Gris Grey	615 Hêtre Haya Beech	616 Chêne Moyen Roble Maple	617 Poirier Peral Pear	612 Argent Plata Silver	618 Wengué Wengue	440 Acacia Clair Acacia Clara Light Acacia	443 Acacia Foncé Acacia Oscura Dark Acacia	446 Zebrano Zebrano Zebrano	619 Graphite 25 Grafito 25 Graphite 25	
	637 Blanc Blanco White	638 Gris Gris Grey	639 Hêtre Haya Beech	640 Chêne Moyen Roble Maple	641 Poirier Peral Pear	636 Argent Plata Silver	642 Wengué Wengue	793 Acacia Clair Acacia Clara Light Acacia	794 Acacia Foncé Acacia Oscura Dark Acacia	795 Zebrano Zebrano Zebrano	643 Graphite 25 Grafito 25 Graphite 25	
	453 Blanc Blanco White	454 Gris Gris Grey	455 Hêtre Haya Beech	461 Chêne Moyen Roble Maple	462 Poirier Peral Pear	451 Argent Plata Silver	486 Wengué Wengue	796 Acacia Clair Acacia Clara Light Acacia	797 Acacia Foncé Acacia Oscura Dark Acacia	798 Zebrano Zebrano Zebrano	487 Graphite 25 Grafito 25 Graphite 25	





MODÈLES | VARIANTES | VERSIONS

CAISSONS / CAJONERAS / PEDESTALS

MODÈLE / VARIANTES / VERSIONS	TYPE / TIPO / TYPE	DIMENSIONS / MEDIDAS / MEASUREMENTS	RÉFÉRENCE / REFERENCIA / CODE	
	Haut de gamme / Gama alta / Top range Gamme basique / Gama básica / Basic range Gamme mélamine / Gama madera / Melamine drawer	Prof./ Depth. 80 cm 44 x 73 cm 44 x 73 cm 44 x 73 cm	4 Tiroirs / Cajones / Drawers	2 Tiroirs / Cajones / Drawers + 1 DS / Archivo / File
Caisson HB top rectangulaire Cajonera adosada Fixed pedestal with top			402.400.--- 402.402.--- 402.404.---	402.401.--- 402.403.--- 402.405.---
	Haut de gamme / Gama alta / Top range Gamme basique / Gama básica / Basic range Gamme mélamine / Gama madera / Melamine drawer	Prof./ Depth. 60 cm 44 x 73 cm 44 x 73 cm 44 x 73 cm	402.342.--- 402.352.--- 402.363.---	402.343.--- 402.353.--- 402.364.---
Caisson porteur Cajonera soportante Fixed pedestal (under desk top)				
	Haut de gamme / Gama alta / Top range Gamme basique / Gama básica / Basic range Gamme mélamine / Gama madera / Melamine drawer	Prof./ Depth. 80 cm 43 x 70,5 cm 43 x 70,5 cm 43 x 70,5 cm	3 Tiroirs / Cajones / Drawers	1 Tiroir / Cajón / Drawer + 1 DS / Archivo / File
Caisson à roulettes Cajonera con ruedas Mobile pedestal			402.300.--- 402.310.--- 402.320.---	402.301.--- 402.311.--- 402.321.---
	Haut de gamme / Gama alta / Top range Gamme basique / Gama básica / Basic range Gamme mélamine / Gama madera / Melamine drawer	Type / Tipo / Type 1 43,4 x 52,5 x 57,8 cm 43,4 x 52,5 x 57,8 cm 43,4 x 52,5 x 57,8 cm	3 Tiroirs / Cajones / Drawers	1 Tiroir / Cajón / Drawer + 1 DS / Archivo / File
Caisson à roulettes Cajonera con ruedas Mobile pedestal			402.304.--- 402.314.--- 402.326.---	402.305.--- 402.315.--- 402.327.---
	Haut de gamme / Gama alta / Top range Gamme basique / Gama básica / Basic range Gamme mélamine / Gama madera / Melamine drawer	Type / Tipo / Type 2 43,6 x 52,5 x 57,6 cm 43,6 x 52,5 x 57,6 cm 43,6 x 52,5 x 57,6 cm	3 Tiroirs / Cajones / Drawers	1 Tiroir / Cajón / Drawer + 1 DS / Archivo / File
Caisson à roulettes Cajonera con ruedas Mobile pedestal			402.306.--- 402.316.--- 402.328.---	402.307.--- 402.317.--- 402.329.---

FINITIONS | ACABADOS | FINISHES

CORPS / ESTRUCTURA / FRAME | FAÇADES ET TOP / DELANTERAS Y SOBRE / FRONTS AND TOP

	051 Argent Plata Silver	053 Blanc Blanco White	054 Gris Gris Grey	055 Hêtre Haya Beech	061 Chêne Moyen Roble Maple	062 Poirier Peral Pear
	116 Wengué Wengue	694 Acacia Clair Acacia Clara Light Acacia	695 Acacia Foncé Acacia Oscura Dark Acacia	696 Zebrano Zebrano Zebrano	125 Graphite 25 Grafito 25 Graphite 25	
	081 Blanc Blanco White	197 Gris Gris Grey	198 Hêtre Haya Beech	199 Chêne Moyen Roble Maple	200 Poirier Peral Pear	
	202 Wengué Wengue	103 Acacia Clair Acacia Clara Light Acacia	104 Acacia Foncé Acacia Oscura Dark Acacia	105 Zebrano Zebrano Zebrano	204 Graphite 25 Grafito 25 Graphite 25	

MODÈLES | VARIANTES | VERSIONS

CRÉDENCE / CREDENCIA / CREDENZA

MODÈLE / VARIANTES / VERSIONS	TYPE / TIPO / TYPE	DIMENSIONS / MEDIDAS / MEASUREMENTS	RÉFÉRENCE / REFERENCIA / CODE	
 <p>Crédenca en mélamine "TYPE A" Credencia de melamina "TIPO A" Melamine credenza "TYPE A"</p>	Haut de gamme / Gama alta / Top range Gamme basique / Gama básica / Basic range Gamme mélamine / Gama madera / Melamine drawer	Gauche / Izquierda / Left	3 Tiroirs / Cajones / Drawers	1 Tiroir / Cajón / Drawer + 1 DS / Archivo / File
		125,6 x 54,2 x 57,5 cm	362.405. - - -	362.407. - - -
		125,6 x 54,2 x 57,5 cm	362.425. - - -	362.427. - - -
	Haut de gamme / Gama alta / Top range Gamme basique / Gama básica / Basic range Gamme mélamine / Gama madera / Melamine drawer	Droite / Derecha / Right	3 Tiroirs / Cajones / Drawers	1 Tiroir / Cajón / Drawer + 1 DS / Archivo / File
		125,6 x 54,2 x 57,5 cm	362.404. - - -	362.406. - - -
		125,6 x 54,2 x 57,5 cm	362.445. - - -	362.447. - - -

FINITIONS | ACABADOS | FINISHES

CORPS / ESTRUCTURA / FRAME

FAÇADES ET TOP / DELANTERAS Y SOBRE / FRONTS AND TOP

Argent Plata Silver	053 Blanc Blanco White	054 Gris Grey	055 Hêtre Haya Beech	061 Chêne Moyen Roble Maple	062 Poirier Peral Pear
	116 Wengué Wengue	694 Acacia Clair Acacia Clara Light Acacia	695 Acacia Foncé Acacia Oscura Dark Acacia	696 Zebrano Zebrano	
Monochrome Monocolor Single-colour	081 Blanc Blanco White	197 Gris Grey	198 Hêtre Haya Beech	199 Chêne Moyen Roble Maple	200 Poirier Peral Pear
	202 Wengué Wengue	103 Acacia Clair Acacia Clara Light Acacia	104 Acacia Foncé Acacia Oscura Dark Acacia	105 Zebrano Zebrano	



metálica

| ARMOIRES
| À RIDEAUX

| ARMARIOS
| PERSIANA

| TAMBOUR DOORS

METÁLICA est une série d'armoires métalliques pouvant être montées ou démontées. Elle dispose d'une grande variété de modèles et de finitions.

METÁLICA es una serie de armarios metálicos que se pueden adquirir montados o desmontados. Dispone de una amplia gama de tipos y acabados.

METÁLICA is a range of metal cabinets that can be ordered assembled or disassembled. It has a wide range of types and finishes.

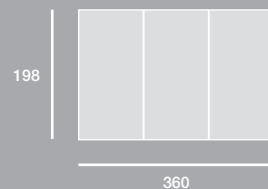

Poignée métallique
(finition structure)
Tirador metálico
(acabado estructura)
Metal handle
(frame finish)

BASIC



Poignée PVC
(Fermeture magnétique)
Tirador PVC
(Cierre magnético)
PVC handle
(Magnetic closing)

PLUS

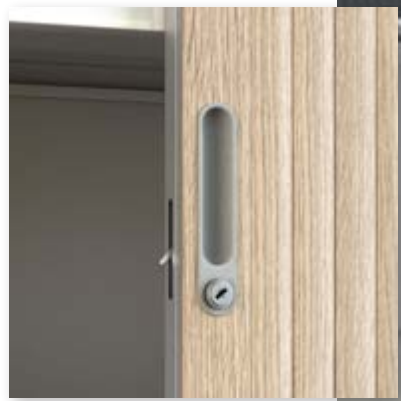

Tops d'union
individuels et multiples
Tapas individuales
y múltiples
Individual
and multiple tops

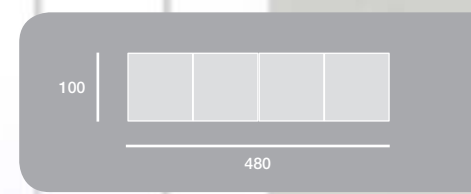



ARMOIRES
DÉMONTÉES
(RIDEAU)

ARMARIO
DESMONTADO
(PERSIANA)

DISASSEMBLED
TAMBOUR DOORS
CABINET

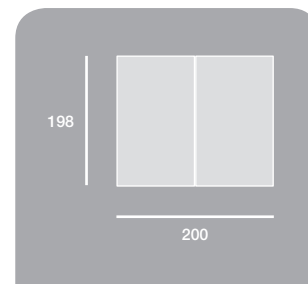

|PENDERIE

|ROPERO

|WARDROBE

La distribution des étagères est idéale pour tous les besoins.

La disposición interior de los estantes del armario ropero es ideal para cualquier necesidad.

Shelves are ready to arrange any kind of clothing need.

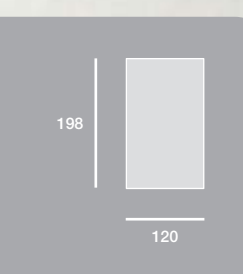

ARMOIRES
OUVERTES -
PORTES

ARMARIOS
HUECO -
PUERTAS

CABINET WITH
SHELVES AND
LOW DOORS

198

360

PORTES
EN MÉLAMINE

PUERTAS
DE MELAMINA

MELAMINE
DOORS



Réglage des tablettes intérieures au pas de 25 mm.
 Laterales con cremallera cada 25 mm.
 Sides drilled every 25 mm.

ARMOIRE
 OUVERTE
 AVEC
 ÉTAGÈRES

ARMARIOS
 HUECO

SHELVES
 CABINET

ARMOIRES DS
 TÉLESCOPIQUES

ARCHIVOS
 TELESCÓPICOS

TELESCOPIC
 FILES

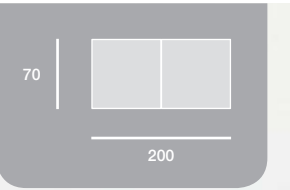

Armoires pour les dossiers suspendus.
 Ideal para colgar carpetas
 For hanging folders.

| CAISSON
| PORTEURS
| MÉTALLIQUES

| CAJONERA
| METÁLICA
| SOPORTANTE

| METAL
| FIXED
| PEDESTAL



Finitions métalliques: argent, blanc ou graphite.
Disponible en tres acabados: plata, blanco o grafito.
Available in three finishes: silver, white or graphite.

| CAISSON HAUTEUR BUREAU
| CAJONERA METÁLICA ADOSADA
| FIXED PEDESTALS

Ouverture des tiroirs sans poignée.
Sistema de apertura muy práctico sin tirador.
Opening system is without handle.



| CAISSON À ROULETTES
| CAJONERA CON RUEDAS
| MOBILE PEDESTAL

Une bonne solution pour avoir un meuble auxiliaire.
Ideal como mueble auxiliar.
It is a perfect solution as an auxiliar furniture.



| CRÉDENCE MÉTALLIQUE
| CREDENCIA METÁLICA
| METAL CREDENZA

Espace pour UC + porte coulissante + tiroirs.
Con hueco para CPU + puerta corredera + cajones.
With CPU gap + sliding door + drawers.



| ACCESSOIRES CAISSONS - PVC
| ACCESORIOS PARA CUBETAS
| PEDESTAL ACCESSORIES

MODÈLES | VARIANTES | VERSIONS

ARMOIRES / ARMARIOS / CABINETS

ÉTAGÈRES INCLUSES / ESTANTES INCLUIDOS / INCLUDED SHELVES

MODÈLE / VARIANTES / VERSIONS	TYPE / TIPO / TYPE	H.	RÉFÉRENCE / REFERENCIA / CODE		
			L. 120 cm	L. 100 cm	L. 80 cm
	Prof./ Depth. 43 cm	198 cm	BASIC	BASIC	BASIC
		160 cm	195.302.-	195.312.-	195.322.-
		135 cm	195.303.-	195.313.-	195.323.-
		100 cm	195.305.-	195.315.-	195.325.-
		70 cm	195.307.-	195.317.-	195.327.-
		50 cm	195.309.-	195.319.-	195.329.-
			195.010.-	195.020.-	195.030.-

Armoires à rideaux
Puertas persiana
Tambour doors cabinet

MODÈLE / VARIANTES / VERSIONS	TYPE / TIPO / TYPE	H.	RÉFÉRENCE / REFERENCIA / CODE		
			L. 120 cm	L. 100 cm	L. 80 cm
	Type / tipo / type A-B Prof./ Depth. 43 cm	198 cm	BASIC		
		160 cm	195.332.-	195.333.-	

Penderie à rideaux
Ropero con puertas persiana
Wardrobe with tambour doors

MODÈLES | VARIANTES | VERSIONS

ARMOIRES / ARMARIOS / CABINETS

ÉTAGÈRES INCLUSES / ESTANTES INCLUIDOS / INCLUDED SHELVES

MODÈLE / VARIANTES / VERSIONS	TYPE / TIPO / TYPE	H.	RÉFÉRENCE / REFERENCIA / CODE		
			L. 120 cm	L. 100 cm	L. 80 cm
	Prof./ Depth. 43 cm	198 cm	PLUS	PLUS	PLUS
		160 cm	195.402.-	195.412.-	195.422.-
		135 cm	195.403.-	195.413.-	195.423.-
		100 cm	195.405.-	195.415.-	195.425.-
		70 cm	195.407.-	195.417.-	195.427.-
		50 cm	195.409.-	195.419.-	195.429.-
			195.210.-	195.220.-	195.230.-

Armoires à rideaux
Puertas persiana
Tambour doors cabinet





MODÈLE / VARIANTES / VERSIONS	TYPE / TIPO / TYPE	H.	RÉFÉRENCE / REFERENCIA / CODE		
			L. 120 cm	L. 100 cm	L. 80 cm
	Type / tipo / type A-B Prof./ Depth. 43 cm	198 cm	PLUS		
		160 cm	195.432.-	195.433.-	

Penderie à rideaux
Ropero con puertas persiana
Wardrobe with tambour doors

FINITIONS | ACABADOS | FINISHES

STRUCTURE ARMOIRE MÉTALLIQUE
ESTRUCTURA LIBRERÍA EN METAL
METAL FRAME





PVC

BASIC	TYPE / TIPO / TYPE A		TYPE / TIPO / TYPE B													
	500	Gris Gris Grey	501	Blanc Blanco White	502	Argent Plata Silver	503	Hêtre Haya Beech	504	Chêne Moyen Roble Maple	505	Poirier Peral Pear	506	Wengué Wengue Wengue	754	Acacia Clair Acacia Clara Light Acacia
	507	Gris estres Gris estres Grey estres	755	Acacia Foncé Acacia Oscura Dark Acacia	756	Zebrano Zebrano Zebrano	510	Graphite Grafito Graphite								
	511	Gris Gris Grey	512	Blanc Blanco White	513	Argent Plata Silver	514	Hêtre Haya Beech	515	Chêne Moyen Roble Maple	516	Poirier Peral Pear	517	Wengué Wengue Wengue	757	Acacia Clair Acacia Clara Light Acacia
	758	Acacia Foncé Acacia Oscura Dark Acacia	759	Zebrano Zebrano Zebrano	521	Graphite Grafito Graphite										
	544	Gris Gris Grey	545	Blanc Blanco White	546	Argent Plata Silver	547	Hêtre Haya Beech	548	Chêne Moyen Roble Maple	549	Poirier Peral Pear	550	Wengué Wengue Wengue	760	Acacia Clair Acacia Clara Light Acacia
	761	Acacia Foncé Acacia Oscura Dark Acacia	762	Zebrano Zebrano Zebrano	557	Graphite Grafito Graphite										
	558	Gris Gris Grey	559	Blanc Blanco White	560	Argent Plata Silver	565	Hêtre Haya Beech	566	Chêne Moyen Roble Maple	567	Poirier Peral Pear	568	Wengué Wengue Wengue	763	Acacia Clair Acacia Clara Light Acacia
	764	Acacia Foncé Acacia Oscura Dark Acacia	765	Zebrano Zebrano Zebrano	572	Graphite Grafito Graphite										

FINITIONS | ACABADOS | FINISHES

STRUCTURE ARMOIRE MÉTALLIQUE
ESTRUCTURA LIBRERÍA EN METAL
METAL FRAME

PVC

PLUS	TYPE / TIPO / TYPE E		TYPE / TIPO / TYPE F													
	522	Gris Gris Grey	523	Blanc Blanco White	524	Argent Plata Silver	525	Hêtre Haya Beech	526	Chêne Moyen Roble Maple	527	Poirier Peral Pear	528	Wengué Wengue Wengue	769	Acacia Clair Acacia Clara Light Acacia
	529	Gris estres Gris estres Grey estres	770	Acacia Foncé Acacia Oscura Dark Acacia	771	Zebrano Zebrano Zebrano	532	Graphite Grafito Graphite								
	533	Gris Gris Grey	534	Blanc Blanco White	535	Argent Plata Silver	536	Hêtre Haya Beech	537	Chêne Moyen Roble Maple	538	Poirier Peral Pear	539	Wengué Wengue Wengue	772	Acacia Clair Acacia Clara Light Acacia
	773	Acacia Foncé Acacia Oscura Dark Acacia	774	Zebrano Zebrano Zebrano	543	Graphite Grafito Graphite										
	573	Gris Gris Grey	574	Blanc Blanco White	575	Argent Plata Silver	576	Hêtre Haya Beech	577	Chêne Moyen Roble Maple	578	Poirier Peral Pear	579	Wengué Wengue Wengue	775	Acacia Clair Acacia Clara Light Acacia
	776	Acacia Foncé Acacia Oscura Dark Acacia	777	Zebrano Zebrano Zebrano	583	Graphite Grafito Graphite										
	584	Gris Gris Grey	585	Blanc Blanco White	586	Argent Plata Silver	587	Hêtre Haya Beech	588	Chêne Moyen Roble Maple	589	Poirier Peral Pear	590	Wengué Wengue Wengue	778	Acacia Clair Acacia Clara Light Acacia
	779	Acacia Foncé Acacia Oscura Dark Acacia	780	Zebrano Zebrano Zebrano	594	Graphite Grafito Graphite										

MODÈLES | VARIANTES | VERSIONS

ARMOIRES / ARMARIOS / CABINETS





ÉTAGÈRES INCLUSES / ESTANTES INCLUIDOS / INCLUDED SHELVES

MODÈLE / VARIANTES / VERSIONS	TYPE / TIPO / TYPE	H.	RÉFÉRENCE / REFERENCIA / CODE		
	Prof./ Depth. 43 cm	198 cm 160 cm 135 cm 100 cm 70 cm 50 cm	L. 120 cm 197.002... 197.003... 197.005... 197.007... 197.009... 197.010...	L. 100 cm 197.012... 197.013... 197.015... 197.017... 197.019... 197.020...	L. 80 cm 197.022... 197.023... 197.025... 197.027... 197.029... 197.030...
Armoire ouverte avec étagères Armario hueco Shelves cabinet			FINITIONS ACABADOS FINISHES 303 RAL 7035 301 RAL 7015 111 RAL 9006 108 RAL 9016		
	Prof./ Depth. 43 cm	198 cm 160 cm 135 cm 100 cm 70 cm 50 cm	L. 120 cm 197.202... 197.203... 197.205... 197.207... 197.209... 197.210...	L. 100 cm 197.212... 197.213... 197.215... 197.217... 197.219... 197.220...	L. 80 cm 197.222... 197.223... 197.225... 197.227... 197.229... 197.230...
Armoire portes battantes Armario con puertas batientes Hinged doors cabinet					
	Prof./ Depth. 43 cm	198 cm 160 cm	197.290... 197.292...		
Penderie portes battantes Ropero con puertas Wardrobe with doors					
	Prof./ Depth. 43 cm	198 cm 160 cm 135 cm	197.240... 197.242... 197.244...	197.246... 197.248... 197.250...	197.252... 197.254... 197.256...
Armoire DS Archivo File cabinet					
	Prof./ Depth. 43 cm	198 cm 160 cm 135 cm	197.272... 197.274... 197.275...	197.276... 197.278... 197.279...	197.280... 197.282... 197.284...
Armoire ouverte - portes Hueco - puertas Shelves with low doors					
	Prof./ Depth. 43 cm	198 cm 160 cm 135 cm	197.260... 197.262... 197.263...	197.264... 197.266... 197.267...	197.268... 197.270... 197.271...
Armoire ouverte - DS Hueco - archivo Shelves with low files					

FINITIONS | ACABADOS | FINISHES

STRUCTURE ARMOIRE MÉTALLIQUE
ESTRUCTURA LIBRERÍA EN METAL
METAL FRAME

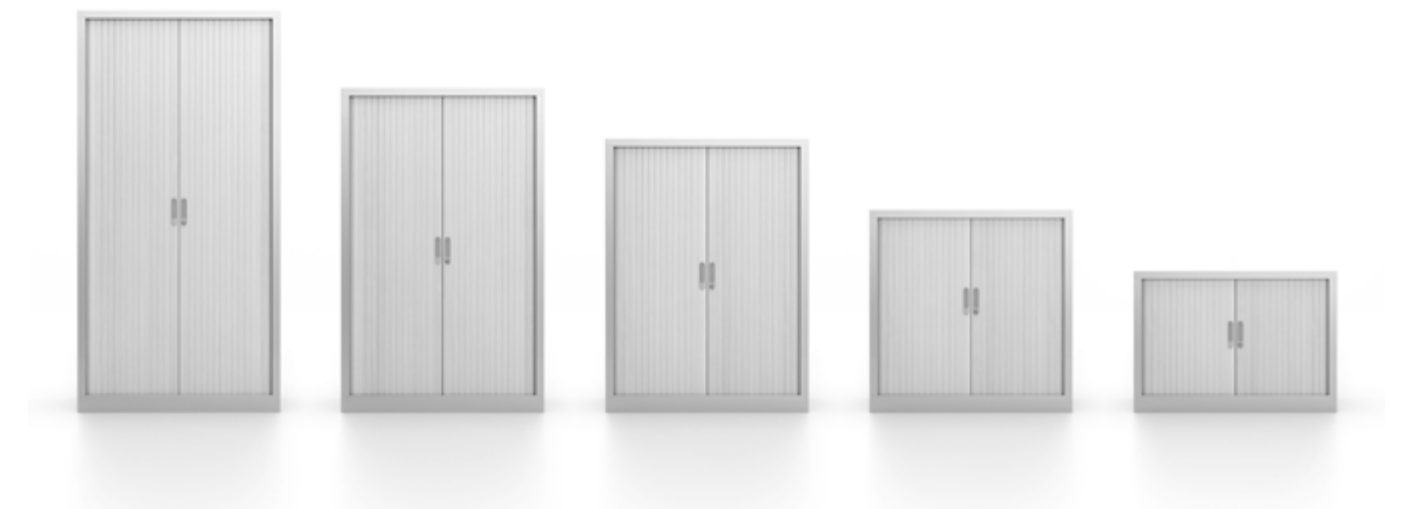

JEU DE PORTES ET FAÇADES
JUEGO DE PUERTAS Y DELANTERAS
HINGED DOORS AND FRONTS

	389 Argent Plata Silver	390 Blanc Blanco White	391 Gris Gris Grey	392 Hêtre Haya Beech	393 Chêne Moyen Roble Maple	394 Poirier Peral Pear	395 Wengué Wengue
	739 Acacia Clair Acacia Clara Light Acacia	740 Acacia Foncé Acacia Oscura Dark Acacia	741 Zebrano Zebrano	389 Graphite Grafito Graphite			
	687 Argent Plata Silver	688 Blanc Blanco White	689 Gris Gris Grey	690 Hêtre Haya Beech	691 Chêne Moyen Roble Maple	692 Poirier Peral Pear	693 Wengué Wengue
	742 Acacia Clair Acacia Clara Light Acacia	743 Acacia Foncé Acacia Oscura Dark Acacia	744 Zebrano Zebrano	687 Graphite Grafito Graphite			
	040 Argent Plata Silver	060 Blanc Blanco White	064 Gris Gris Grey	065 Hêtre Haya Beech	066 Chêne Moyen Roble Maple	067 Poirier Peral Pear	068 Wengué Wengue
	706 Acacia Clair Acacia Clara Light Acacia	707 Acacia Foncé Acacia Oscura Dark Acacia	708 Zebrano Zebrano	040 Graphite Grafito Graphite			
	095 Argent Plata Silver	096 Blanc Blanco White	097 Gris Gris Grey	098 Hêtre Haya Beech	099 Chêne Moyen Roble Maple	100 Poirier Peral Pear	101 Wengué Wengue
	709 Acacia Clair Acacia Clara Light Acacia	710 Acacia Foncé Acacia Oscura Dark Acacia	711 Zebrano Zebrano	095 Graphite 25 Grafito 25 Graphite 25			





MODÈLES | VARIANTES | VERSIONS

CAISSONS / CAJONERAS / PEDESTALS

MODÈLE / VARIANTES / VERSIONS	TYPE / TIPO / TYPE	DIMENSIONS / MEDIDAS / MEASUREMENTS	RÉFÉRENCE / REFERENCIA / CODE	
 Caisson HB top rectangulaire Cajonera adosada Fixed pedestal with top	Prof./ Depth. 55 cm	42 x 70,5 cm	4 Tiroirs / Cajones / Drawers 402.072.-.-	2 Tiroirs / Cajones / Drawers + 1 DS / Archivo / File 402.073.-.-
 Caisson HB top arc Cajonera adosada con sobre arco Fixed pedestal with bow top	Prof./ Depth. 55 cm	42 x 70,5 cm	402.074.-.-	402.075.-.-



FINITIONS | ACABADOS | FINISHES

CORPS / ESTRUCTURA / FRAME | TOP / SOBRES / TOP

Color / Code	095	060	064	065	066	067
 RAL 9006	Argent Plata Silver	Blanc Blanco White	Gris Gris Grey	Hêtre Haya Beech	Chêne Moyen Roble Maple	Poirier Peral Pear
 RAL 9016	068 Wengué Wengue	706 Acacia Clair Acacia Clara Light Acacia	707 Acacia Foncé Acacia Oscura Dark Acacia	708 Zebrano Zebrano Zebrano	020 Graphite Grafito Graphite	
 RAL 7022	126 Argent Plata Silver	096 Blanc Blanco White	097 Gris Gris Grey	098 Hêtre Haya Beech	099 Chêne Moyen Roble Maple	100 Poirier Peral Pear
	101 Wengué Wengue	709 Acacia Clair Acacia Clara Light Acacia	710 Acacia Foncé Acacia Oscura Dark Acacia	711 Zebrano Zebrano Zebrano	126 Graphite Grafito Graphite	
	160 Argent Plata Silver	163 Blanc Blanco White	180 Gris Gris Grey	181 Hêtre Haya Beech	182 Chêne Moyen Roble Maple	183 Poirier Peral Pear
	184 Wengué Wengue	715 Acacia Clair Acacia Clara Light Acacia	716 Acacia Foncé Acacia Oscura Dark Acacia	717 Zebrano Zebrano Zebrano	113 Graphite Grafito Graphite	

MODÈLES | VARIANTES | VERSIONS

CAISSONS / CAJONERAS / PEDESTALS

MODÈLE / VARIANTES / VERSIONS	TYPE / TIPO / TYPE	DIMENSIONS / MEDIDAS / MEASUREMENTS	RÉFÉRENCE / REFERENCIA / CODE	
 Caisson porteur Cajonera soportante Fixex pedestal (under desk top)	Prof./ Depth. 55 cm	42 x 70,5 cm	4 Tiroirs / Cajones / Drawers 402.032.-.-	2 Tiroirs / Cajones / Drawers + 1 DS / Archivo / File 402.033.-.-
 Caisson à roulettes Cajonera con ruedas Mobile pedestal	Prof./ Depth. 55 cm	42 x 70,5 cm	402.036.-.-	402.037.-.-

FINITIONS | ACABADOS | FINISHES

 RAL 9006	 RAL 9016	 RAL 7022
---	---	---

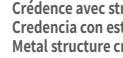

MODÈLES | VARIANTES | VERSIONS

CRÉDENCE / CREDENCIA / CREDENZA

MODÈLE / VARIANTES / VERSIONS	TYPE / TIPO / TYPE	DIMENSIONS / MEDIDAS / MEASUREMENTS	RÉFÉRENCE / REFERENCIA / CODE	
	Haut de gamme / Gama alta / Top range Gamme basique / Gama básica / Basic range Gamme mélamine / Gama madera / Melamine drawer	125,6 x 54,2 x 57,5 cm 125,6 x 54,2 x 57,5 cm 125,6 x 54,2 x 57,5 cm	Gauche / Izquierda / Left 362.415.-.- 362.435.-.- 362.455.-.-	362.417.-.- 362.437.-.- 362.457.-.-
	Haut de gamme / Gama alta / Top range Gamme basique / Gama básica / Basic range Gamme mélamine / Gama madera / Melamine drawer	125,6 x 54,2 x 57,5 cm 125,6 x 54,2 x 57,5 cm 125,6 x 54,2 x 57,5 cm	Droite / Derecha / Right 362.414.-.- 362.434.-.- 362.454.-.-	362.416.-.- 362.436.-.- 362.456.-.-

FINITIONS | ACABADOS | FINISHES

CORPS / ESTRUCTURA / FRAME | FAÇADES ET TOP / DELANTERAS Y SOBRE / FRONT AND TOP

Color / Code	096	097	098	099	100
 RAL 9016	Blanc Blanco White	Gris Gris Grey	Hêtre Haya Beech	Chêne Moyen Roble Maple	Poirier Peral Pear
 RAL 9006	060 Blanc Blanco White	064 Gris Gris Grey	065 Hêtre Haya Beech	066 Chêne Moyen Roble Maple	067 Poirier Peral Pear
	101 Wengué Wengue	709 Acacia Clair Acacia Clara Light Acacia	710 Acacia Foncé Acacia Oscura Dark Acacia	711 Zebrano Zebrano Zebrano	
	068 Wengué Wengue	706 Acacia Clair Acacia Clara Light Acacia	707 Acacia Foncé Acacia Oscura Dark Acacia	708 Zebrano Zebrano Zebrano	

INDEX

| FAMILLES SIÈGES | FAMILIAS DE SILLAS | CHAIR FAMILIES



264 | LED



276 | BROS



| OPÉRATIF | OPERATIVAS | OFFICE



292 | IITA



300 | KCLASS



310 | WHY



316 | IARO



324 | IM4



332 | IVIGO



340 | PLUS



346 | EXAGONUS



352 | COPA



358 | IM8



366 | IRIS

| DIRECTION | DIRECCIÓN | EXECUTIVE



372 | ELBA



378 | VIC



384 | CRETA



392 | EVOLE

| CONTRACT | CONTRACT | CONTRACT



400 | MORK



410 | MINDY



420 | FRILL



430 | NO-FRILL



440 | LOOLA



446 | NUT



452 | HOLE



458 | HOP



466 | LINER



472 | NEST



480 | MR. JONES

| COLLECTIVITÉS | AUXILIARES | VISITOR



488 | TOM



500 | MARCO



510 | REPLAY



518 | ONDARA



528 | VIENA



536 | RÓDANO



544 | SPLIT



550 | NAVIA



| CANAPÉS | SOFÁS | SOFAS



558 | SF1



562 | SF2



566 | SF3

POUTRES:
BANCADAS:
BEAMS:

- LED
- BROS
- TOM

Led

La famille de sièges LED est la plus complète de notre catalogue. Sièges de direction, opératifs et visiteurs disponibles en plusieurs finitions et sur différents types de structure.

La familia de sillas LED es la más completa del catálogo. Abarca des de sillas de dirección con cabezal, sillas operativas con respaldos en distintos acabados hasta sillas de visita con todo tipos de estructura.

LED chairs range is the most complete of our catalogue. Executive chairs with headrest, office chairs with different backrest finishes and visitor chairs with any kind of frame.

SIÈGE
DIRECTION

SILLA
DIRECCIÓN

EXECUTIVE
CHAIR



VISITEUR
LUGE

CONFIDENTE
BALANCÍN

CANTILEVER
CHAIR



Tête réglable
Regulación cabezal
Headrest adjustment



Réglable en hauteur
Regulación altura
Height adjustment



Support lombaire réglable
Regulación lumbar
Lumbar support adjustment

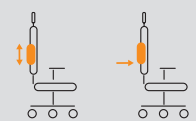

Accoudoirs réglables
Regulación brazos
Arms adjustment

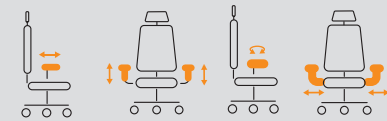

Assise réglable en profondeur et synchrone
Asiento regulable en profundidad y sincro
Seat depth adjustment and synchro mechanism

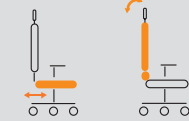

| SIÈGE OPÉRATIF

| OPERATIVA

| TASK CHAIR



Siège avec accoudoirs réglables ou sans accoudoirs.
Se puede escoger sin brazos o con brazos regulables.
With or without adjustable arms.

Réglable en hauteur
Regulación altura
Height adjustment



Support lombaire réglable
Regulación lumbar
Lumbar support adjustment

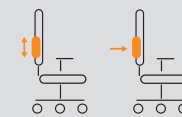

Assise réglable en profondeur et synchrone
Asiento regulable en profundidad y sincro
Seat depth adjustment and synchro mechanism

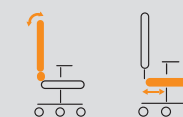

Accoudoirs réglables
Regulación brazos
Arms adjustment



GIRATOIRE
SUR PATINS

GIRATORIA
CON TOPES

SWIVEL
CHAIR



Base chromée ou noire.
La base puede ser
cromada o negra.
Black or chrome swivel
frame.

Réglable en hauteur
Regulación altura
Height adjustment



EMPILABLE / APILABLE / STACKABLE



Disponibile avec ou sans tablette écriteiro.
Puede tener la pala escribanía como complemento.
Writing tablet is available as a complement.

VISITEUR
4 PIEDS

SILLA
DE 4 PATAS

4 LEGS
CHAIR



| POUTRE

| BANCADA

| BEAM FRAME



Polypropylène
 Polipropileno
 Polypropylene



Flexpu®
 Flexpu®
 Flexpu®

Tissu
 Tapizada
 Upholstered

Résille
 Rejilla
 Mesh

La structure est également disponible en version à fixer ou sol.
 La estructura puede ser fija atornillada en el suelo o móvil.
 Beam structure can be fixed to the floor or free.

MODÈLES | VARIANTES | VERSIONS

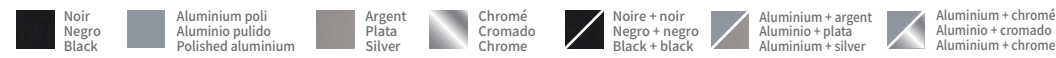

MODÈLE / VARIANTES / VERSIONS	TYPE / TIPO / TYPE	RÉFÉRENCE / REFERENCIA / CODE		
	Translation d'assise / Traslo / Seat depth adjustment Accoudoirs réglables / Brazos regulables / Adjustable arms	Base Base Base		
Direction Dirección Executiva	FINITIONS ACABADOS FINISHES	TYPE A / TIPO A / TYPE A	111	118
		TYPE G / TIPO G / TYPE G	321	328
		TYPE M / TIPO M / TYPE M	711	718

	Sans accoudoirs / Sin brazos / Without arms Accoudoirs réglables / Brazos regulables / Adjustable arms	Base Base Base		
Opératifs Operativa Task	FINITIONS ACABADOS FINISHES	TYPE A / TIPO A / TYPE A	111	118
		TYPE G / TIPO G / TYPE G	321	328
		TYPE M / TIPO M / TYPE M	711	718

	Sans accoudoirs / Sin brazos / Without arms Accoudoirs fixes / Con brazos / Fixed arms	Base + Structure Base + Estructura Base + Frame			
Giratoire Giratoria Swivel	FINITIONS ACABADOS FINISHES	TYPE A / TIPO A / TYPE A	102	103	104
		TYPE G / TIPO G / TYPE G	222	223	224
		TYPE M / TIPO M / TYPE M	612	613	614
		TYPE C / TIPO C / TYPE C	452	453	454
			442	443	444
			422	423	424
			432	433	434
			482	483	484
			472	473	474

	Accoudoirs fixes / Brazos fijos / Fixed arms	Structure Estructura Frame			
Visiteur 4 pieds Confidente 4 patas 4 legs	FINITIONS ACABADOS FINISHES	TYPE A / TIPO A / TYPE A	111	117	119
		TYPE G / TIPO G / TYPE G	321	327	329
		TYPE M / TIPO M / TYPE M	711	717	719
		TYPE C / TIPO C / TYPE C	551	655	559
			541	645	549
			521	625	529
			531	635	539
			581	685	589
			571	675	579

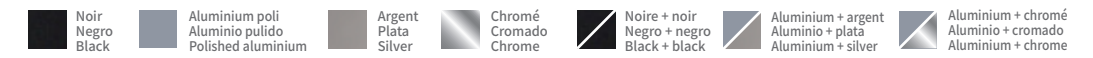

MODÈLE / VARIANTES / VERSIONS	TYPE / TIPO / TYPE	DIMENSIONS / MEDIDAS / MEASUREMENTS	RÉFÉRENCE / REFERENCIA / CODE		
	Accoudoirs fixes / Brazos fijos / Fixed arms	Structure Estructura Frame			
Luge Balancín Cantilever	FINITIONS ACABADOS FINISHES	TYPE A / TIPO A / TYPE A	111	117	119
		TYPE G / TIPO G / TYPE G	321	327	329
		TYPE M / TIPO M / TYPE M	711	717	719
		TYPE C / TIPO C / TYPE C	551	655	559
			541	645	549
			521	625	529
			531	635	539
			581	685	589
			571	675	579

	À droite / Derecha / Right hand À gauche / Izquierda / Left hand	Structure Estructura Frame			
Visiteur 4 pieds avec tablette écriiroite renforcée (noire) Confidente 4 patas con escribania reforzada (negro) 4 legs with writing tablet (black)	FINITIONS ACABADOS FINISHES	TYPE A / TIPO A / TYPE A	111	113	115
		TYPE G / TIPO G / TYPE G	321	323	325
		TYPE M / TIPO M / TYPE M	711	713	715
		TYPE C / TIPO C / TYPE C	551	553	555
			541	543	545
			521	523	525
			531	533	535
			581	583	585
			571	573	575

	Sans accoudoirs / Sin brazos / Without arms Accoudoirs fixes / Con brazos / Fixed arms	Structure Estructura Frame			
Poutres Bancadas Beams	FINITIONS ACABADOS FINISHES	TYPE A / TIPO A / TYPE A	111	117	119
		TYPE G / TIPO G / TYPE G	321	327	329
		TYPE M / TIPO M / TYPE M	711	717	719
		TYPE C / TIPO C / TYPE C	551	655	559
			541	645	549
			521	625	529
			531	635	539
			581	685	589
			571	675	579

TYPE A / TIPO A / TYPE A
TYPE G / TIPO G / TYPE G
TYPE M / TIPO M / TYPE M

Cf. page 574
Ver pagina 574
See page 574

Structure / Estructura / Beam structure

2P. 151,5 x 40 X 60 cm
3P. 201,5 x 40 X 60 cm
4P. 251,5 x 40 X 60 cm
5P. 301,5 x 40 X 60 cm

67.003.124	67.003.131
67.005.124	67.005.131
67.007.124	67.007.131
67.009.124	67.009.131

BROS

Chaise conçue pour aménager tous les espaces imaginables de bureaux, salles polyvalentes ou d'attente.

Diseñada y desarrollada para equipar todos los espacios imaginables en nuestras oficinas, zonas polivalentes y salas de espera.

Designed and created to furnish all type of spaces in the office, multipurpose zones and waiting areas.

SIÈGE
DIRECTION

SILLA
DIRECCIÓN

EXECUTIVE
CHAIR



Réglable en hauteur
Regulación altura
Height adjustment



Accoudoirs réglables
Regulación brazos
Arms adjustment

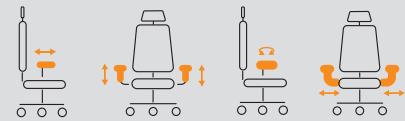

Assise réglable en profondeur et synchro
Asiento regulable en profundidad y sincro
Seat depth adjustment and synchro mechanism

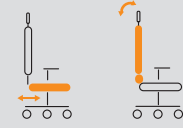

| SIÈGE OPÉRATIF

| OPERATIVA

| TASK CHAIR



Siège avec accoudoirs réglables ou sans accoudoirs.
Se puede escoger sin brazos o con brazos regulables.
With or without adjustable arms.

Réglable en hauteur
Regulación altura
Height adjustment

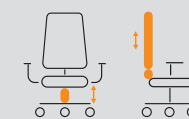

Support lombaire réglable
Regulación lumbar
Lumbar support adjustment

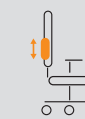

Assise réglable en profondeur et synchrone
Asiento regulable en profundidad y sincro
Seat depth adjustment and synchro mechanism

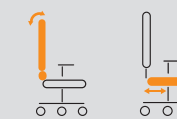

Accoudoirs réglables
Regulación brazos
Arms adjustment

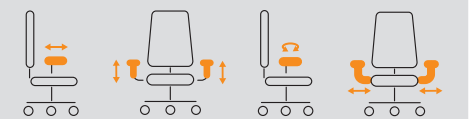



| VISITEUR
| 4 PIEDS

| SILLA
| 4 PATAS

| 4 LEGS
| CHAIR



La structure peut être en noir, argent, blanc, graphite ou chromé.

La estructura de cuatro patas puede ser en acabado: negro, plata, blanco, grafito o cromado.

Four legs structure is available in: black, silver, white, graphite or chrome finishes.

EMPILABLE / APILABLE / STACKABLE



VISITEUR
LUGE

SILLA
BALANCÍN

CANTILEVER
CHAIR

EMPILABLE / APILABLE / STACKABLE



Assise et dossier tapissé au choix.
Monocarcasa plástica tapizada.
Single upholstered shell.



Disponible avec ou sans tablette écrite.
Puede tener la pala escribanía
como complemento.
Writing tablet is available as a
complement.

CHAISE PIEDS
TRAÎNEAU

SILLA CON
ESTRUCTURA PATÍN

SLED
FRAME CHAIR



| POUTRE

| BANCADA

| BEAM FRAME



| Polypropylène
| Polipropileno
| Polypropylene

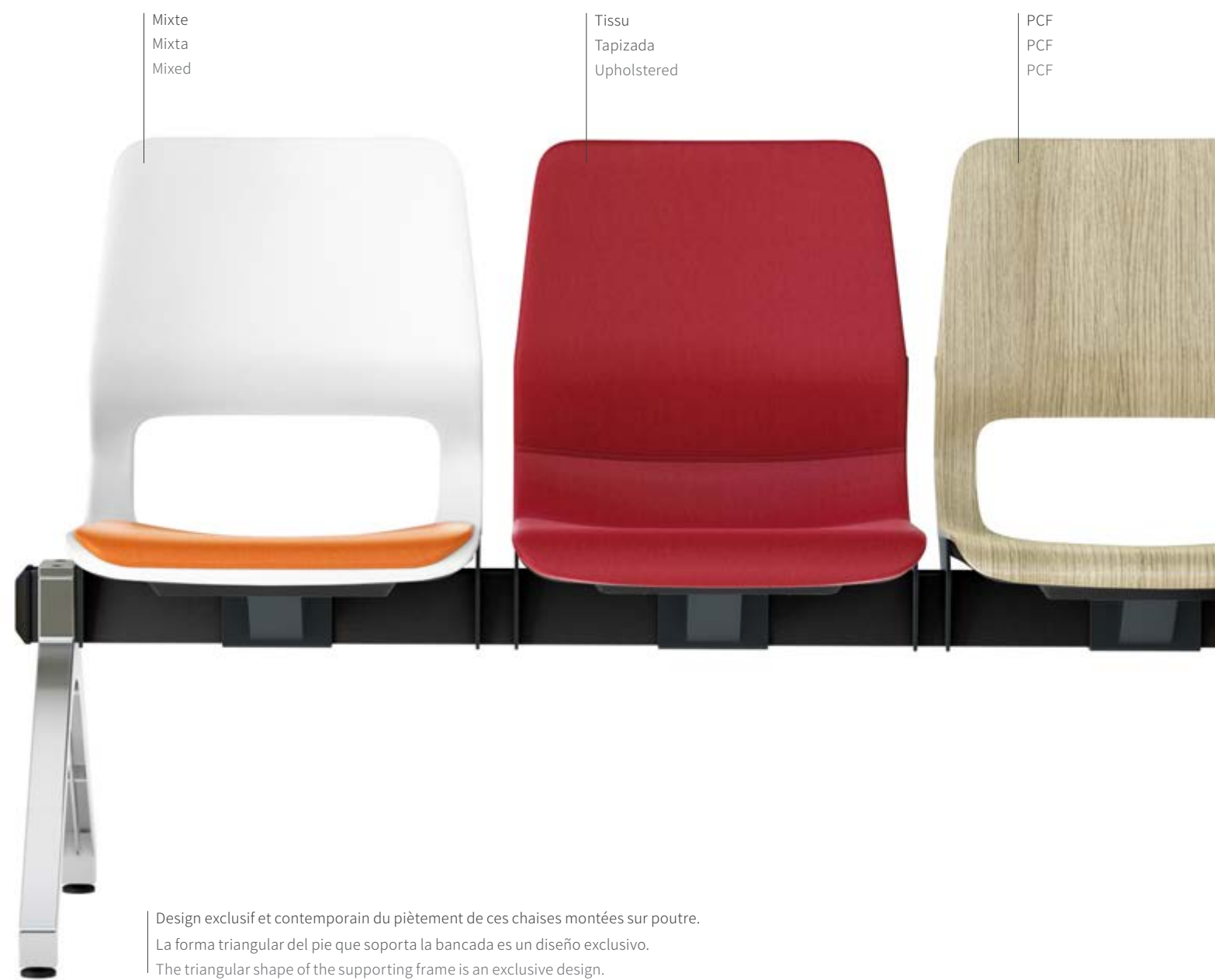

| Mixte
| Mixta
| Mixed



| Tissu
| Tapizada
| Upholstered



| PCF
| PCF
| PCF



| Design exclusif et contemporain du piètement de ces chaises montées sur poutre.
| La forma triangular del pie que soporta la bancada es un diseño exclusivo.
| The triangular shape of the supporting frame is an exclusive design.

MODÈLES | VARIANTES | VERSIONS



MODÈLE / VARIANTES / VERSIONS	TYPE / TIPO / TYPE	RÉFÉRENCE / REFERENCIA / CODE
 <p>Translation d'assise / Traslo / Seat depth adjustment</p> <p>Accoudoirs réglables / Brazos regulables / Adjustable arms</p> <p>Direction Dirección Executive</p>		 <p>57.437.--- 57.437.---</p>
<p>FINITIONS ACABADOS FINISHES</p> <p>TYPE A / TIPO A / TYPE A 120 125</p> <p>TYPE G / TIPO G / TYPE G 320 325</p>		

 <p>Translation d'assise / Traslo / Seat depth adjustment</p> <p>Sans accoudoirs / Sin brazos / Without arms</p> <p>Opératifs Operativa Task</p>		 <p>57.431.--- 57.431.---</p>
<p>Accoudoirs réglables / Brazos regulables / Adjustable arms</p> <p>57.433.--- 57.433.---</p>		
<p>FINITIONS ACABADOS FINISHES</p> <p>TYPE A / TIPO A / TYPE A 120 125</p> <p>TYPE G / TIPO G / TYPE G 320 325</p>		

 <p>Structure avec roulettes / base con ruedas / base with castors</p> <p>Giratoire avec accoudoirs Giratoria con brazos Swivel</p>		 <p>57.002.101 57.102.101 57.402.101</p>
<p>Structure avec patins / base con topes / base with glides</p> <p>57.012.101 57.112.101 57.412.101</p>		



 <p>4 Pieds avec accoudoirs 4 Patas con brazos 4 Legs with arms</p>		 <p>57.072.101 57.172.101 57.272.101 57.372.101 57.472.101</p>
--	--	--

 <p>Luge avec accoudoirs Balancín con brazos Cantilever with arms</p>		 <p>57.082.101 57.182.101 57.282.101 57.382.101 57.482.101</p>
--	--	--



MODÈLE / VARIANTES / VERSIONS	RÉFÉRENCE / REFERENCIA / CODE
 <p>Pieds traîneau avec accoudoirs Patín con brazos Sled frame with arms</p>	 <p>57.094.101 57.194.101 57.294.101 57.394.101 57.494.101</p>

 <p>Pieds traîneau sans accoudoirs Patín sin brazos Sled frame without arms</p>	 <p>57.093.101 57.193.101 57.293.101 57.393.101 57.493.101</p>
--	---

 <p>Pieds traîneau avec accoudoirs Patín con brazos Sled frame with arms</p>	 <p>57.092.--- 57.192.--- 57.292.--- 57.392.--- 57.492.---</p>
---	---

 <p>Pieds traîneau sans accoudoirs Patín sin brazos Sled frame without arms</p>	 <p>57.091.--- 57.191.--- 57.291.--- 57.391.--- 57.491.---</p>
---	---

FINITIONS | ACABADOS | FINISHES

* PCF = 75% PP + 20% calcium + 5% FG

TYPE N
TIPO N
TYPE N

ASSISE ET DOSSIER: TISSU AU CHOIX
ASIENTO Y RESPALDO: TAPIZADO A ELEGIR
UPHOLSTERED SEAT AND BACKREST

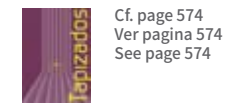

TYPE O
TIPO O
TYPE O

ASSISE ET DOSSIER EN *PCF
ASIENTO Y RESPALDO EN *PCF
*PCF SEAT AND BACKREST

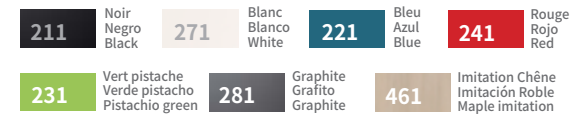

TYPE P
TIPO P
TYPE P

DOSSIER EN *PCF
RESPALDO EN *PCF
*PCF BACKREST

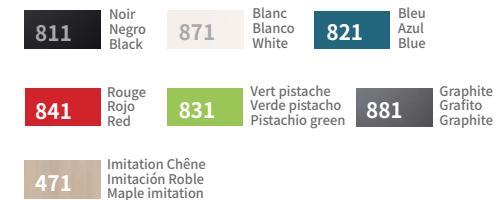

ASSISE: TISSU AU CHOIX
ASIENTO: TAPIZADO A ELEGIR
UPHOLSTERED SEAT

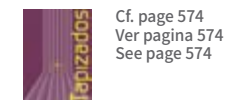



MODÈLES | VARIANTES | VERSIONS



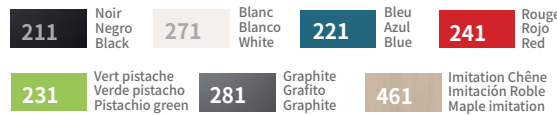
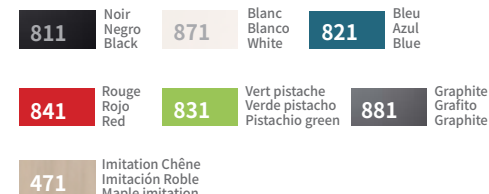

MODÈLE / VARIANTES / VERSIONS	RÉFÉRENCE / REFERENCIA / CODE
 <p>Pieds traîneau avec accoudoirs, tablette écriroire à droite (noire) Patín con brazos, escribanía mano derecha (negra) Sled frame with arms, RIGHT hand writing tablet (black)</p>	 57.097.101 57.197.101 57.297.101 57.397.101 57.497.101
 <p>Pieds traîneau avec accoudoirs, tablette écriroire à gauche (noire) Patín con brazos, escribanía mano izquierda (negra) Sled frame with arms, LEFT hand writing tablet (black)</p>	 57.098.101 57.198.101 57.298.101 57.398.101 57.498.101
 <p>Pieds traîneau avec accoudoirs, tablette écriroire à droite (noire) Patín con brazos, escribanía mano derecha (negra) Sled frame with arms, RIGHT hand writing tablet (black)</p>	 57.095.--- 57.195.--- 57.295.--- 57.395.--- 57.495.---
 <p>Pieds traîneau avec accoudoirs, tablette écriroire à gauche (noire) Patín con brazos, escribanía mano izquierda (negra) Sled frame with arms, LEFT hand writing tablet (black)</p>	 57.096.--- 57.196.--- 57.296.--- 57.396.--- 57.496.---

FINITIONS | ACABADOS | FINISHES



* PCF = 75% PP + 20% calcium + 5% FG

TYPE TIPO TYPE	N	ASSISE ET DOSSIER: TISSU AU CHOIX ASIENTO Y RESPALDO: TAPIZADO A ELEGIR UPHOLSTERED SEAT AND BACKREST	 Cf. page 574 Ver pagina 574 See page 574
TYPE TIPO TYPE	O	ASSISE ET DOSSIER EN *PCF ASIENTO Y RESPALDO EN *PCF *PCF SEAT AND BACKREST	
TYPE TIPO TYPE	P	DOSSIER EN *PCF RESPALDO EN *PCF *PCF BACKREST	
		ASSISE: TISSU AU CHOIX ASIENTO: TAPIZADO A ELEGIR UPHOLSTERED SEAT	 Cf. page 574 Ver pagina 574 See page 574

MODÈLE / VARIANTES / VERSIONS	TYPE / TIPO / TYPE	RÉFÉRENCE / REFERENCIA / CODE
 <p>Poutres Bancadas Beams</p>	TYPE / TIPO / TYPE N	57.065.101
	TYPE / TIPO / TYPE O	57.064.---
	TYPE / TIPO / TYPE P	57.064.---
	Structure / Estructura / Beam structure	 2P. 111,2 x 40,5 X 58,7 cm 3P. 161,2 x 40,5 X 58,7 cm 4P. 211,2 x 40,5 X 58,7 cm 5P. 261,2 x 40,5 X 58,7 cm
Accoudoirs pour poutres / Brazos para bancadas / Armrests	 Jeu d'accoudoirs / Juego de brazos / Arm set Accoudoir droit / Brazo derecho / Right arm Accoudoir gauche / Brazo izquierdo / Left arm	57.067.124 57.167.111 57.467.131 57.068.124 57.168.111 57.468.131 57.069.124 57.169.111 57.469.131

FINITIONS | ACABADOS | FINISHES

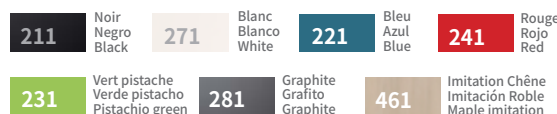
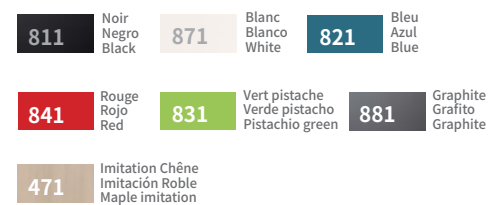
* PCF = 75% PP + 20% calcium + 5% FG

TYPE TIPO TYPE	N	ASSISE ET DOSSIER: TISSU AU CHOIX ASIENTO Y RESPALDO: TAPIZADO A ELEGIR UPHOLSTERED SEAT AND BACKREST	 Cf. page 574 Ver pagina 574 See page 574
TYPE TIPO TYPE	O	ASSISE ET DOSSIER EN *PCF ASIENTO Y RESPALDO EN *PCF *PCF SEAT AND BACKREST	
TYPE TIPO TYPE	P	DOSSIER EN *PCF RESPALDO EN *PCF *PCF BACKREST	
		ASSISE: TISSU AU CHOIX ASIENTO: TAPIZADO A ELEGIR UPHOLSTERED SEAT	 Cf. page 574 Ver pagina 574 See page 574

ita

Sièges et fauteuils opératifs disponibles dans de nombreuses versions. Une gamme de sièges design et confortable dont les éléments structurels sont de grande qualité et résistance.

Silla y sillón operativos con múltiples posibilidades. Una gama de sillería que destaca por su diseño y confort, junto con unos elementos estructurales de gran calidad y resistencia.

Executive and task chair with multiple possibilities. A range of seats that stands out for its design and comfort, along with some structural elements of high quality and durability.

| SIÈGE OPÉRATIF

| OPERATIVA

| TASK CHAIR



Réglable en hauteur
Regulación altura
Height adjustment

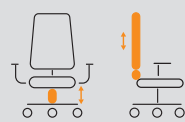

Support lombaire réglable
Regulación lumbar
Lumbar support adjustment



Assise réglable en profondeur et synchro
Asiento regulable en profundidad y sincro
Seat depth adjustment and synchro mechanism

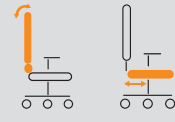

Accoudoirs réglables
Regulación brazos
Arms adjustment





SIÈGE
DIRECTION

SILLA
DIRECCIÓN

EXECUTIVE
CHAIR



Siège avec accoudoirs réglables, fixes ou sans accoudoirs.
Disponibile con braccioli regolabili, fissi o sin braccioli.
With or without adjustable or fixed arms.

<p>Tête réglable Regulación cabezal Headrest adjustment</p>	<p>Réglable en hauteur Regulación altura Height adjustment</p>	<p>Support lombaire réglable Regulación lumbar Lumbar support adjustment</p>	<p>Accoudoirs réglables Regulación brazos Arms adjustment</p>	<p>Assise réglable en profondeur et synchrone Asiento regulable en profundidad y sincro Seat depth adjustment and synchro mechanism</p>

| VISITEUR
| LUGE

| CONFIDENTE
| BALANCÍN

| CANTILEVER
| CHAIR

| Structure disponible en blanc,
noir, argent ou chromé.
Disponible con estructura en
blanco, negro, plata o cromado.
Available frame in: black, white,
silver or chrome finishes.



MODÈLES | VARIANTES | VERSIONS

MODÈLE / VARIANTES / VERSIONS	TYPE / TIPO / TYPE	RÉFÉRENCE / REFERENCIA / CODE			
	Translation d'assise / Traslo / Seat depth adjustment	Accoudoirs fixes / Con brazos / Fixed arms	151.098.327	151.598.327	
		Accoudoirs réglables / Brazos regulables / Adjustable arms	151.099.327	151.599.327	
		Accoudoirs fixes / Con brazos / Fixed arms	151.038.327	151.538.327	
		Accoudoirs réglables / Brazos regulables / Adjustable arms	151.039.327	151.539.327	
		Accoudoirs fixes / Con brazos / Fixed arms	151.038.327	151.538.327	
		Accoudoirs réglables / Brazos regulables / Adjustable arms	151.039.327	151.539.327	
	Direction Dirección Executive				

	Translation d'assise / Traslo / Seat depth adjustment	Accoudoirs fixes / Con brazos / Fixed arms	151.098.377	151.598.377	
		Accoudoirs réglables / Brazos regulables / Adjustable arms	151.099.377	151.599.377	
		Accoudoirs fixes / Con brazos / Fixed arms	151.038.377	151.538.377	
		Accoudoirs réglables / Brazos regulables / Adjustable arms	151.039.377	151.539.377	
		Accoudoirs fixes / Con brazos / Fixed arms	151.038.377	151.538.377	
		Accoudoirs réglables / Brazos regulables / Adjustable arms	151.039.377	151.539.377	
	Direction avec support lombaire Dirección lumbar ajustable Executive with lumbar support				

	Translation d'assise / Traslo / Seat depth adjustment	Sans accoudoirs / Sin brazos / Without arms	151.091.327	151.591.327
		Accoudoirs fixes / Con brazos / Fixed arms	151.092.327	151.592.327
		Accoudoirs réglables / Brazos regulables / Adjustable arms	151.093.327	151.593.327
		Sans accoudoirs / Sin brazos / Without arms	151.031.327	151.531.327
		Accoudoirs fixes / Con brazos / Fixed arms	151.032.327	151.532.327
		Accoudoirs réglables / Brazos regulables / Adjustable arms	151.033.327	151.533.327
Opératifs Operativa Task				

	Translation d'assise / Traslo / Seat depth adjustment	Sans accoudoirs / Sin brazos / Without arms	151.091.377	151.591.377
		Accoudoirs fixes / Con brazos / Fixed arms	151.092.377	151.592.377
		Accoudoirs réglables / Brazos regulables / Adjustable arms	151.093.377	151.593.377
		Sans accoudoirs / Sin brazos / Without arms	151.031.377	151.531.377
		Accoudoirs fixes / Con brazos / Fixed arms	151.032.377	151.532.377
		Accoudoirs réglables / Brazos regulables / Adjustable arms	151.033.377	151.533.377
Opératifs avec support lombaire Operativa lumbar ajustable Task with lumbar support				

FINITIONS | ACABADOS | FINISHES

BASE + COQUE
BASE + CARCASA
BASE + SHELL

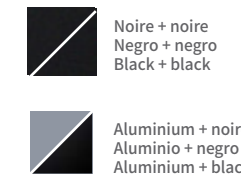



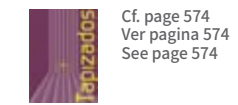

ASSISE: TISSU AU CHOIX
ASIENTO: TAPIZADO A ELEGIR
UPHOLSTERED SEAT



Cf. page 574
Ver pagina 574
See page 574

MODÈLES | VARIANTES | VERSIONS

MODÈLE / VARIANTES / VERSIONS	RÉFÉRENCE / REFERENCIA / CODE			
	 151.082.327	 151.182.327	 151.782.327	 151.482.327
Luge Balancín Cantilever				

FINITIONS | ACABADOS | FINISHES

STRUCTURE + COQUE
ESTRUCTURA + CARCASA
FRAME + SHELL



ASSISE: TISSU AU CHOIX
ASIENTO: TAPIZADO A ELEGIR
UPHOLSTERED SEAT

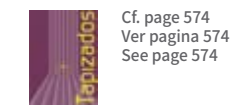

Cf. page 574
Ver pagina 574
See page 574

klass

Polyvalence et esthétique qualifient cette famille de siège au design contemporain. L'ergonomie du siège KLASS est renforcé par les formes actuelles et prononcées de ses différents modèles d'accoudoirs.

Versatilidad y estética. Modelo con un diseño ergonómico de líneas rectas y puras en el que destaca su versatilidad y variedad de posibilidades. KLASS presume de un carácter acentuado gracias a sus diferentes reposabrazos de formas muy pronunciadas.

Versatility and design. Ergonomic chair with straight and defined lines that maximize its versatility and the variety of models. The distinct armrests give this chair an outstanding character.

| SIÈGE OPÉRATIF

| OPERATIVA

| TASK CHAIR



Réglable en hauteur
Regulación altura
Height adjustment



Soutien lombaire réglable
Regulación lumbar
Lumbar support adjustment

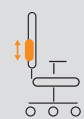

Accoudoirs réglables
Regulación brazos
Arms adjustment



Assise réglable en profondeur et synchrone
Asiento regulable en profundidad y sincro
Seat depth adjustment and synchro mechanism

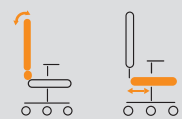

SIÈGE
DIRECTION

SILLA
DIRECCIÓN

EXECUTIVE
CHAIR



Assise et dossier en tissu avec structure chromée.
El cabezal es un elemento que se tapiza también.
Headrest can be upholstered aswell.



Tête réglable
Regulación cabezal
Headrest adjustment

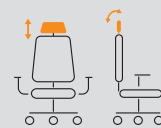

Réglable en hauteur
Regulación altura
Height adjustment

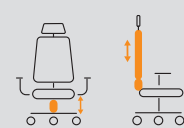

Accoudoirs réglables
Regulación brazos
Arms adjustment

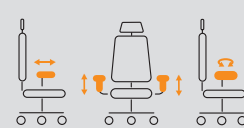

Assise réglable en profondeur et synchro
Asiento regulable en profundidad y sincro
Seat depth adjustment and synchro mechanism

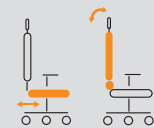

| SIÈGE OPÉRATIF

| OPERATIVA

| TASK CHAIR



Réglable en hauteur
Regulación altura
Height adjustment

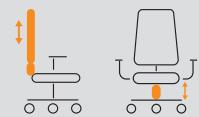

Accoudoirs réglables
Regulación brazos
Arms adjustment

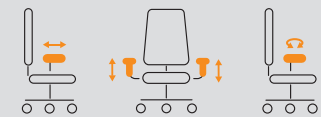

Assise réglable en profondeur et synchrone
Asiento regulable en profundidad y sincro
Seat depth adjustment and synchro mechanism

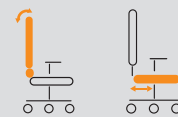

Siège opératif et luge peuvent avoir le dossier en résille ou tapissé.
La silla operativa y balancín pueden tener el respaldo tapizado o con rejilla.
Task chair and cantilever can have meshed or upholstered backrest.

| VISITEUR
| LUGE

| CONFIDENTE
| BALANCÍN

| CANTILEVER
| CHAIR



| Deux modèles d'accoudoirs fixes.
| Las brazos fijos tienen 2 diseños
| muy característicos.
| Fixed arms are available in 2
| different shapes.



MODÈLES | VARIANTES | VERSIONS

MODÈLE / VARIANTES / VERSIONS	TYPE / TIPO / TYPE	RÉFÉRENCE / REFERENCIA / CODE								
<p>Direction Dirección Executive</p>	Translation d'assise / Traslo / Seat depth adjustment	<table border="1"> <tr> <td></td> <td></td> <td></td> <td></td> </tr> <tr> <td>144.098.107</td> <td>144.298.108</td> <td>144.598.107</td> <td>144.598.108</td> </tr> </table>					144.098.107	144.298.108	144.598.107	144.598.108
144.098.107	144.298.108	144.598.107	144.598.108							
Accoudoirs fixes / Con brazos / Fixed arms	144.099.107	144.599.107								
	Accoudoirs fixes / Con brazos / Fixed arms	144.038.107	144.238.108	144.538.107	144.538.108					
	Accoudoirs réglables / Brazos regulables / Adjustable arms	144.039.107	144.539.107							
<p>Opératifs Operativa Task</p>	Sans accoudoirs / Sin brazos / Without arms	144.091.107	144.291.108	144.591.107	144.591.108					
	Translation d'assise / Traslo / Seat depth adjustment	144.092.107	144.292.108	144.592.107	144.592.108					
	Accoudoirs réglables / Brazos regulables / Adjustable arms	144.093.107	144.593.107							
<p>Opératifs Operativa Task</p>	Sans accoudoirs / Sin brazos / Without arms	144.031.107	144.231.108	144.531.107	144.531.108					
	Accoudoirs fixes / Con brazos / Fixed arms	144.032.107	144.232.108	144.532.107	144.532.108					
	Accoudoirs réglables / Brazos regulables / Adjustable arms	144.033.107	144.533.107							
<p>Luge Balancín Cantilever</p>	Sans accoudoirs / Sin brazos / Without arms	144.081.107	144.181.108	144.481.107	144.481.108					
	Accoudoirs fixes / Con brazos / Fixed arms	144.082.107	144.182.108	144.482.107	144.482.108					

FINITIONS | ACABADOS | FINISHES

BASE + COQUE
BASE + CARCASA
BASE + SHELL

- Noire + noire
Negro + negro
Black + black
- Blanche + blanche
Blanco + blanco
White + white
- Aluminium + noire
Aluminio + negro
Aluminium + black
- Aluminium + grise
Aluminio + gris
Aluminium + grey

ASSISE ET DOSSIER: TISSU AU CHOIX
ASIENTO Y RESPALDO: TAPIZADO A ELEGIR
UPHOLSTERED SEAT AND BACKREST

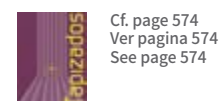

Cf. page 574
Ver pagina 574
See page 574

MODÈLES | VARIANTES | VERSIONS

MODÈLE / VARIANTES / VERSIONS	TYPE / TIPO / TYPE	RÉFÉRENCE / REFERENCIA / CODE								
<p>Opératifs Operativa Task</p>	Translation d'assise / Traslo / Seat depth adjustment	<table border="1"> <tr> <td></td> <td></td> <td></td> <td></td> </tr> <tr> <td>144.091.327</td> <td>144.791.326</td> <td>144.591.327</td> <td>144.591.326</td> </tr> </table>					144.091.327	144.791.326	144.591.327	144.591.326
	144.091.327	144.791.326	144.591.327	144.591.326						
	Sans accoudoirs / Sin brazos / Without arms	144.092.327	144.792.326	144.592.327	144.592.326					
Accoudoirs fixes 1 / Con brazos 1 / Fixed arms 1	144.090.327	144.790.326	144.590.327	144.590.326						
Accoudoirs fixes 2 / Con brazos 2 / Fixed arms 2	144.093.327	144.793.326	144.593.327	144.593.326						
<p>Opératifs Operativa Task</p>	Sans accoudoirs / Sin brazos / Without arms	144.031.327	144.731.326	144.531.327	144.531.326					
	Accoudoirs fixes 1 / Con brazos 1 / Fixed arms 1	144.032.327	144.732.326	144.532.327	144.532.326					
	Accoudoirs fixes 2 / Con brazos 2 / Fixed arms 2	144.030.327	144.730.326	144.530.327	144.530.326					
	Accoudoirs réglables / Brazos regulables / Adjustable arms	144.033.327	144.733.326	144.533.327	144.533.326					
<p>Luge Balancín Cantilever</p>	Sans accoudoirs / Sin brazos / Without arms	144.081.327	144.781.326	144.481.327	144.481.326					
	Accoudoirs fixes 1 / Con brazos 1 / Fixed arms 1	144.082.327	144.782.326	144.482.327	144.482.326					
	Accoudoirs fixes 2 / Con brazos 2 / Fixed arms 2	144.080.327	144.780.326	144.480.327	144.480.326					

FINITIONS | ACABADOS | FINISHES

BASE + COQUE
BASE + CARCASA
BASE + SHELL

- Noire + noire
Negro + negro
Black + black
- Blanche + blanche
Blanco + blanco
White + white
- Aluminium + noire
Aluminio + negro
Aluminium + black
- Aluminium + blanche
Aluminio + blanco
Aluminium + white
- Chromée + noire
Cromado + negro
Chrome + black
- Chromée + blanche
Cromado + blanco
Chrome + white

ASSISE: TISSU AU CHOIX
ASIENTO: TAPIZADO A ELEGIR
UPHOLSTERED SEAT



Cf. page 574
Ver pagina 574
See page 574

Why

| SIÈGE OPÉRATIF

| OPERATIVA

| TASK CHAIR

WHY est un siège opératif aux formes modernes et ergonomiques satisfaisant tous les besoins de l'utilisateur. Respectueux de l'environnement, 98% des composants du siège WHY sont recyclables.

WHY es una silla operativa con formas modernas y ergonómicas que cubre las necesidades básicas del trabajador. Respetuosa con el medio ambiente con un 98% de sus componentes reciclables.

Task chair that provides contemporary design and ergonomic features satisfying employees basic requirements. Environment-friendly chair with 98% recyclable components.



Réglable en hauteur
Regulación altura
Height adjustment

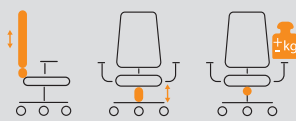

Accoudoirs réglables
Regulación brazos
Arms adjustment

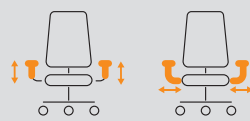

Translation d'assise et dossier réglable
Traslo e inclinación respaldo
Seat depth and backrest adjustment

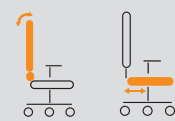

SIÈGE OPÉRATIF
TAPISSÉ

SILLA OPERATIVA
TAPIZADA

UPHOLSTERED
TASK CHAIR



Possibilité d'avoir le dossier tapissé.
El respaldo puede ser tapizado.
Backrest can be upholstered as well.

Coque dossier disponible en noir, gris ou blanc.
Respaldo disponible en color, negro, gris o blanco.
Available backrest finishes: black, grey or white.



Siège disponible avec ou sans accoudoirs.
Disponibile con o sin brazos.
With or without adjustable arms.

MODÈLES | VARIANTES | VERSIONS

MODÈLE / VARIANTES / VERSIONS	TYPE / TIPO / TYPE	RÉFÉRENCE / REFERENCIA / CODE
	Translation d'assise / Traslo / Seat depth adjustment Sans accoudoirs / Sin brazos / Without arms	145.901.2 - -
Opératifs Operativa Task	Translation d'assise / Traslo / Seat depth adjustment Accoudoirs réglables / Brazos regulables / Adjustable arms	145.903.2 - -

FINITIONS | ACABADOS | FINISHES

BASE
BASE
BASE

Noire
Negro
Black
RAL 9005

Aluminium poli
Aluminio pulido
Polished aluminium

DOSSIER
RESPALDO
BACKREST

10 Noire Negro Black 60 Gris Gris Grey 70 Blanc Blanco White

14 Noire Negro Black 64 Gris Gris Grey 74 Blanc Blanco White

ASSISE: TISSU AU CHOIX
ASIENTO: TAPIZADO A ELEGIR
UPHOLSTERED SEAT

 Cf. page 574
Ver pagina 574
See page 574

MODÈLES | VARIANTES | VERSIONS

	Translation d'assise / Traslo / Seat depth adjustment Sans accoudoirs / Sin brazos / Without arms	145.901.8 - -
Opératifs Operativa Task	Translation d'assise / Traslo / Seat depth adjustment Accoudoirs réglables / Brazos regulables / Adjustable arms	145.903.8 - -

FINITIONS | ACABADOS | FINISHES

BASE
BASE
BASE

Noire
Negro
Black
RAL 9005

Aluminium poli
Aluminio pulido
Polished aluminium

COQUE
CARCASA
SHELL

10 Noire Negro Black 60 Grise Gris Grey 70 Blanche Blanco White

14 Noire Negro Black 64 Grise Gris Grey 74 Blanche Blanco White

ASSISE ET DOSSIER: TISSU AU CHOIX
ASIENTO Y RESPALDO: TAPIZADO A ELEGIR
UPHOLSTERED SEAT AND BACKREST

 Cf. page 574
Ver pagina 574
See page 574



Aro

Siège tapissé aux multiples possibilités. Le siège ARO est agrémenté d'un enjoliveur chromé en partie basse du dossier qui lui confère une touche originale et élégante.

Esta silla tiene un respaldo con un embellecedor cromado en la parte inferior que le da un toque original muy especial.

ARO backrest has an original chrome detail that makes this chair very special.

SIÈGE OPÉRATIF
TAPISSÉ

SILLA OPERATIVA
TAPIZADA

UPHOLSTERED
TASK CHAIR



Réglable en hauteur
Regulación altura
Height adjustment

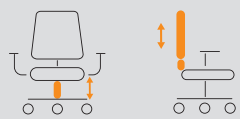

Accoudoirs réglables
Regulación brazos
Arms adjustment



Assise réglable en profondeur et synchrone
Asiento regulable en profundidad y sincro
Seat depth adjustment and synchro mechanism

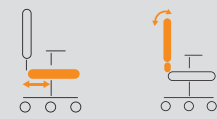



| SIÈGE DIRECTION

| SILLA DIRECCIÓN

| EXECUTIVE CHAIR



Base chromée ou noire.
La base puede ser cromada o negra.
Black or chrome base.

Tête réglable
Regulación cabecal
Headrest adjustment

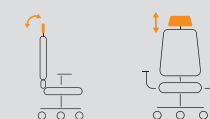

Réglable en hauteur
Regulación altura
Height adjustment

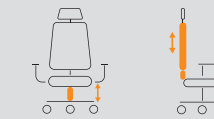

Assise réglable en profondeur et synchrone
Asiento regulable en profundidad y sincro
Seat depth adjustment and synchro mechanism

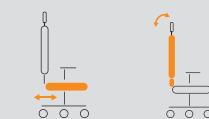

Accoudoirs réglables
Regulación brazos
Arms adjustment

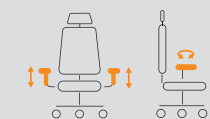

|VISITEUR
|LUGE

|CONFIDENTE
|BALANCÍN









|CANTILEVER
|CHAIR



Dossier avec un détail chromé.
Detalle cromado del respaldo.
Chrome detail of the backrest.



MODÈLES | VARIANTES | VERSIONS

MODÈLE / VARIANTES / VERSIONS	TYPE / TIPO / TYPE	RÉFÉRENCE / REFERENCIA / CODE
	Translation d'assise / Traslo / Seat depth adjustment Accoudoirs réglables / Brazos regulables / Adjustable arms	  137.329.111 137.329.118
	Accoudoirs réglables / Brazos regulables / Adjustable arms	137.029.111 137.029.118
Direction Dirección Executive		
	Translation d'assise / Traslo / Seat depth adjustment Sans accoudoirs / Sin brazos / Without arms Accoudoirs fixes / Con brazos / Fixed arms Accoudoirs réglables / Brazos regulables / Adjustable arms	137.301.111 137.301.118 137.302.111 137.302.118 137.303.111 137.303.118
	Sans accoudoirs / Sin brazos / Without arms Accoudoirs fixes / Con brazos / Fixed arms Accoudoirs réglables / Brazos regulables / Adjustable arms	137.001.111 137.001.118 137.002.111 137.002.118 137.003.111 137.003.118
Opératifs Operativa Task		
	Sans accoudoirs / Sin brazos / Without arms Accoudoirs fixes / Con brazos / Fixed arms	  137.801.111 137.801.118 137.802.111 137.802.118
Luge Balancín Cantilever		

FINITIONS | ACABADOS | FINISHES

BASE
BASE
BASE

 Noire
Negro
Black

 Aluminium
Aluminio
Aluminium

 Chromée
Cromado
Chrome

ASSISE ET DOSSIER: TISSU AU CHOIX
ASIENTO Y RESPALDO: TAPIZADO A ELEGIR
UPHOLSTERED SEAT AND BACKREST



Cf. page 574
Ver pagina 574
See page 574



M4

Siège opératif, disponible en plusieurs dimensions de dossier. Mécanisme synchrone.

Sillón operativo, en diferentes medidas de respaldo con mecanismo sincro, con un alto grado de funcionalidad y confort.

Task chair, available in different backrest sizes, synchro mechanism, high comfort and functionality.

SIÈGE OPERATIF

| SILLA OPERATIVA

| TASK CHAIR



Réglable en hauteur
Regulación altura
Height adjustment

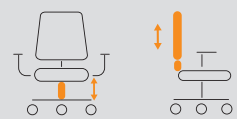

Accoudoirs réglables
Regulación brazos
Arms adjustment

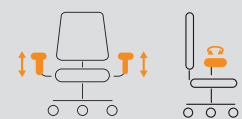

Assise réglable en profondeur et synchrone
Asiento regulable en profundidad y sincro
Seat depth adjustment and synchro mechanism

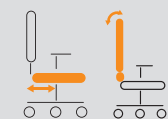



SIÈGE
DIRECTION

Dossier haut disponible.
Respaldo alto disponible.
High backrest available.

SILLA DE
DIRECCIÓN

EXECUTIVE
CHAIR



Réglable en hauteur
Regulación altura
Height adjustment

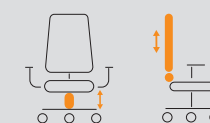

Assise réglable en profondeur et synchrone
Asiento regulable en profundidad y sincro
Seat depth adjustment and synchro mechanism



Accoudoirs réglables
Regulación brazos
Arms adjustment

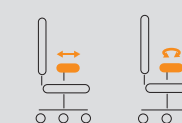

| VISITEUR
| LUGE

| CONFIDENTE
| BALANCÍN



| CANTILEVER
| CHAIR



Siège piètement luge.
Silla de visita con estructura patín.
Visitor chair with cantilever frame.



MODÈLES | VARIANTES | VERSIONS

MODÈLE / VARIANTES / VERSIONS	TYPE / TIPO / TYPE	RÉFÉRENCE / REFERENCIA / CODE
 <p>Opératifs - Dossier haut Operativa - Respaldo alto Task - High backrest</p>	<p>Translation d'assise / Traslo / Seat depth adjustment</p> <p>Sans accoudoirs / Sin brazos / Without arms</p> <p>Accoudoirs réglables / Brazos regulables / Adjustable arms</p>	<p>104.321.001</p> <p>104.323.001</p>
 <p>Opératifs - Dossier moyen Operativa - Respaldo medio Task - Medium backrest</p>	<p>Translation d'assise / Traslo / Seat depth adjustment</p> <p>Sans accoudoirs / Sin brazos / Without arms</p> <p>Accoudoirs réglables / Brazos regulables / Adjustable arms</p>	<p>104.301.001</p> <p>104.303.001</p>
 <p>Opératifs - Dossier bas Operativa Respaldo bajo Task - Low backrest</p>	<p>Translation d'assise / Traslo / Seat depth adjustment</p> <p>Sans accoudoirs / Sin brazos / Without arms</p> <p>Accoudoirs réglables / Brazos regulables / Adjustable arms</p>	<p>104.311.001</p> <p>104.313.001</p>

FINITIONS | ACABADOS | FINISHES

BASE
BASE
BASE

Noire
Negro
Black

Aluminium poli
Aluminio pulido
Polished aluminium

ASSISE ET DOSSIER: TISSU AU CHOIX
ASIENTO Y RESPALDO: TAPIZADO A ELEGIR
UPHOLSTERED SEAT AND BACKREST



Cf. page 574
Ver pagina 574
See page 574

MODÈLES | VARIANTES | VERSIONS

MODÈLE / VARIANTES / VERSIONS	TYPE / TIPO / TYPE	RÉFÉRENCE / REFERENCIA / CODE
 <p>Luge Balancín Cantilever</p>	<p>Accoudoirs fixes / Con brazos / Fixed arms</p>	<p>104.812.001</p>

FINITIONS | ACABADOS | FINISHES

STRUCTURE
ESTRUCTURA
FRAME

Chromée
Cromado
Chrome

ASSISE ET DOSSIER: TISSU AU CHOIX
ASIENTO Y RESPALDO: TAPIZADO A ELEGIR
UPHOLSTERED SEAT AND BACKREST



Cf. page 574
Ver pagina 574
See page 574



Vigo

Siège ergonomique avec mécanisme synchro de grande performance et plus de confort.

Silla ergonómica con mecanismo sincronizado de 3 posiciones y grandes prestaciones, posibilitando un mayor confort en el trabajo.

Ergonomic chair with synchro mechanism and high performance, providing a great comfort at workplaces.

| SIÈGE OPERATIF

| SILLA OPERATIVA

| TASK CHAIR



Réglable en hauteur
Regulación altura
Height adjustment

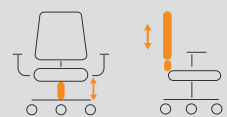

Support lombaire réglable
Regulación lumbar
Lumbar support adjustment



Assise réglable en profondeur et synchro
Asiento regulable en profundidad y sincro
Seat depth adjustment and synchro mechanism

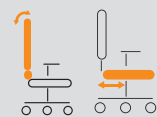

Accoudoirs réglables
Regulación brazos
Arms adjustment

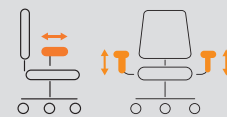



SIÈGE
DIRECTION

SILLA DE
DIRECCIÓN

EXECUTIVE
CHAIR

Dossier réssille disponible en noir, bleu ou rouge.
Rejilla disponible en negro, azul o rojo.
Backrest mesh available in black, blue or red finishes.



Réglable en hauteur
Regulación altura
Height adjustment

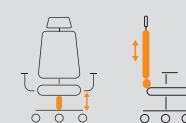

Support lombaire réglable
Regulación lumbar
Lumbar support adjustment



Accoudoirs réglables
Regulación brazos
Arms adjustment

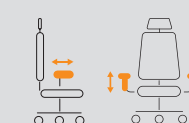

Assise réglable en profondeur et synchrone
Asiento regulable en profundidad y sincro
Seat depth adjustment and synchro
mechanism



VISITEUR
LUGE

CONFIDENTE
BALANCÍN





CANTILEVER
CHAIR











Siège visiteur avec support lombaire.
La silla de visita dispone de soporte lumbar.
Visitor chair has lumbar support.



MODÈLES | VARIANTES | VERSIONS

MODÈLE / VARIANTES / VERSIONS	TYPE / TIPO / TYPE	RÉFÉRENCE / REFERENCIA / CODE
 <p>Direction avec translation d'assise Dirección con traslo Executive with seat depth adjustment</p>	Accoudoirs réglables / Brazos regulables / Adjustable arms	135.329.-...
 <p>Direction Dirección Executive</p>	Accoudoirs réglables / Brazos regulables / Adjustable arms	135.029.-...
 <p>Opératifs avec translation d'assise Operativa con traslo Task with seat depth adjustment</p>	Sans accoudoirs / Sin brazos / Without arms Accoudoirs fixes / Brazos fijos / Fixed arms Accoudoirs réglables / Brazos regulables / Adjustable arms	135.301.-... 135.302.-... 135.303.-...
 <p>Opératifs Operativa Task</p>	Sans accoudoirs / Sin brazos / Without arms Accoudoirs fixes / Brazos fijos / Fixed arms Accoudoirs réglables / Brazos regulables / Adjustable arms	135.001.-... 135.002.-... 135.003.-...









FINITIONS | ACABADOS | FINISHES

BASE BASE BASE	DOSSIER EN RÉVILLE RESPALDO REJILLA MESH BACKREST	ASSISE: TISSU AU CHOIX ASIENTO: TAPIZADO A ELEGIR UPHOLSTERED SEAT
 Noire Negro Black	 321 Noire Negro Black  381 Rouge Rojo Red  391 Bleu Azul Blue	 Cf. page 574 Ver pagina 574 See page 574
 Aluminium poli Aluminio pulido Polished aluminium	 328 Noire Negro Black  388 Rouge Rojo Red  398 Bleu Azul Blue	

MODÈLES | VARIANTES | VERSIONS

MODÈLE / VARIANTES / VERSIONS	TYPE / TIPO / TYPE	RÉFÉRENCE / REFERENCIA / CODE
 <p>Luge Balancín Cantilever</p>	Sans accoudoirs / Sin brazos / Without arms Accoudoirs fixes / Con brazos / Fixed arms	135.801.-... 135.802.-...

FINITIONS | ACABADOS | FINISHES

STRUCTURE ESTRUCTURA FRAME	DOSSIER EN RÉVILLE RESPALDO REJILLA MESH BACKREST	ASSISE: TISSU AU CHOIX ASIENTO: TAPIZADO A ELEGIR UPHOLSTERED SEAT
 Noire Negro Black	 321 Noire Negro Black  381 Rouge Rojo Red  391 Bleu Azul Blue	 Cf. page 574 Ver pagina 574 See page 574
 Chromée Cromado Chrome	 328 Noire Negro Black  388 Rouge Rojo Red  398 Bleu Azul Blue	

Plus

Siège ergonomique pourvu d'un mécanisme synchro de grande qualité lui conférant un excellent confort.

Silla ergonómica con mecanismo synchro de grandes prestaciones, posibilitando un mayor confort en el trabajo.

Ergonomic chair with synchro mechanism and high performance, providing a great comfort at workplaces.

| SIÈGE OPERATIF

| SILLA OPERATIVA

| TASK CHAIR



Réglable en hauteur
Regulación altura
Height adjustment

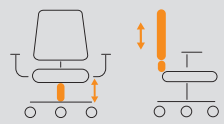

Support lombaire réglable
Regulación lumbar
Lumbar support adjustment

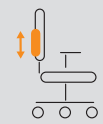

Assise réglable en profondeur et synchrone
Asiento regulable en profundidad y sincro
Seat depth adjustment and synchro mechanism

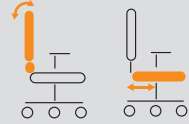

Accoudoirs réglables
Regulación brazos
Arms adjustment

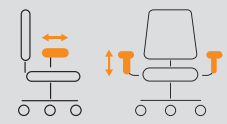



| SIÈGE OPÉRATIF AVEC
| ACCOUDOIRS FIXES

| SILLA OPERATIVA CON
| BRAZOS FIJOS

| TASK CHAIR WITH
| FIXED ARMS

| VISITEUR
| LUGE

| CONFIDENTE
| BALANCÍN

| CANTILEVER
| CHAIR



Support lombaire ajustable.
Con regulación lumbar.
With lumbar support adjustment.



MODÈLES | VARIANTES | VERSIONS

MODÈLE / VARIANTES / VERSIONS	TYPE / TIPO / TYPE	RÉFÉRENCE / REFERENCIA / CODE
	Sans accoudoirs / Sin brazos / Without arms	136.301.-..
	Accoudoirs fixes / Con brazos / Fixed arms	136.302.-..
	Accoudoirs réglables / Brazos regulables / Adjustable arms	136.303.-..



Opératifs avec translation d'assise
Operativa con traslo
Task with seat depth adjustment

	Sans accoudoirs / Sin brazos / Without arms	136.001.-..
	Accoudoirs fixes / Con brazos / Fixed arms	136.002.-..
	Accoudoirs réglables / Brazos regulables / Adjustable arms	136.003.-..





Opératifs
Operativa
Task

FINITIONS | ACABADOS | FINISHES

BASE BASE BASE

	Noire Negro Black
	Aluminium poli Aluminio pulido Polished aluminium

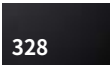
DOSSIER EN RÉVILLE RESPALDO EN REJILLA MESH BACKREST

	321	Noire Negro Black		381	Rouge Rojo Red		391	Bleu Azul Blue
	328	Noire Negro Black		388	Rouge Rojo Red		398	Bleu Azul Blue

ASSISE: TISSU AU CHOIX ASIENTO: TAPIZADO A ELEGIR UPHOLSTERED SEAT

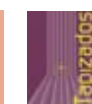

Cf. page 574
Ver pagina 574
See page 574



MODÈLES | VARIANTES | VERSIONS

MODÈLE / VARIANTES / VERSIONS	TYPE / TIPO / TYPE	RÉFÉRENCE / REFERENCIA / CODE
	Sans accoudoirs / Sin brazos / Without arms	136.801.-..
	Accoudoirs fixes / Con brazos / Fixed arms	136.802.-..





Luge
Balancín
Cantilever

FINITIONS | ACABADOS | FINISHES

STRUCTURE ESTRUCTURA FRAME

	Noire Negro Black
	Chromée Cromado Chrome

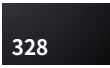
DOSSIER EN RÉVILLE RESPALDO EN REJILLA MESH BACKREST

	321	Noire Negro Black		381	Rouge Rojo Red		391	Bleu Azul Blue
	328	Noire Negro Black		388	Rouge Rojo Red		398	Bleu Azul Blue

ASSISE: TISSU AU CHOIX ASIENTO: TAPIZADO A ELEGIR UPHOLSTERED SEAT

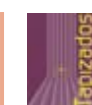

Cf. page 574
Ver pagina 574
See page 574



Exagonus

Série de sièges aux multiples possibilités et combinaisons. Une nouvelle gamme de sièges design et confortable, dont les éléments structurels sont de grande qualité et résistance.

Silla operativa con contacto permanente, en donde la calidad de sus acabados y su ergonomía, nos confieren un bienestar y confort en nuestro hábitat de trabajo.

Office chair with permanent contact, that gives well being and comfort in the workspace thanks to its quality finishes and ergonomics.

| SIÈGE OPÉRATIF

| OPERATIVA

| TASK CHAIR



Réglable en hauteur
Regulación altura
Height adjustment

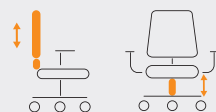

Support lombaire
Soporte lumbar
Lumbar support



Accoudoirs réglables
Regulación brazos
Arms adjustment

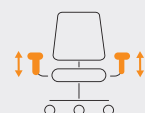

Dossier réglable
Inclinación respaldo
Backrest adjustment





| SIÈGE OPÉRATIF

| OPERATIVA

| TASK CHAIR

| Dossier en tissu ou en résille.
El respaldo puede ser tapizado o con rejilla.
Available upholstered or mesh backrest.



| Base noire ou blanche.
La base puede ser negra o blanca.
White or black 5-star base.

MODÈLES | VARIANTES | VERSIONS

MODÈLE / VARIANTES / VERSIONS	TYPE / TIPO / TYPE	RÉFÉRENCE / REFERENCIA / CODE
	Sans accoudoirs / Sin brazos / Without arms	164.021.107
Opératifs Operativa Task	Accoudoirs réglables / Brazos regulables / Adjustable arms	164.023.107

FINITIONS | ACABADOS | FINISHES

BASE
BASE
BASE

ASSISE ET DOSSIER: TISSU AU CHOIX
ASIENTO Y RESPALDO: TAPIZADO A ELEGIR
UPHOLSTERED SEAT AND BACKREST

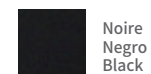

Noire
Negro
Black



Cf. page 574
Ver página 574
See page 574

MODÈLES | VARIANTES | VERSIONS

MODÈLE / VARIANTES / VERSIONS	TYPE / TIPO / TYPE	RÉFÉRENCE / REFERENCIA / CODE	RÉFÉRENCE / REFERENCIA / CODE
	Sans accoudoirs / Sin brazos / Without arms	164.021.---	164.721.---
Opératifs dossier en résille Operativa respaldo en rejilla Mesh backrest task chair	Accoudoirs réglables / Brazos regulables / Adjustable arms	164.023.---	164.723.---

FINITIONS | ACABADOS | FINISHES

BASE
BASE
BASE

DOSSIER EN RÉVILLE
RESPALDO EN REJILLA
MESH BACKREST

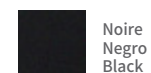

Noire
Negro
Black

327

Noire
Negro
Black

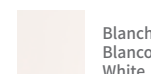

Blanche
Blanco
White

326

Blanche
Blanco
White



Cf. page 574
Ver página 574
See page 574



Copa

Siège ergonomique équipé d'un mécanisme synchrone et bénéficiant d'un rapport qualité/prix exceptionnel.

Silla ergonómica de gran calidad con mecanismo Sincro. Rejilla disponible en múltiples acabados a un precio muy competitivo.

Good quality ergonomic chair with syncro mechanism. Backrest mesh available in a wide range of finishes and with an affordable price.

| SIÈGE OPÉRATIF

| OPERATIVA

| TASK CHAIR



Réglable en hauteur
Regulación altura
Height adjustment



Support lombaire
Soporte lumbar
Lumbar support



Accoudoirs réglables
Regulación brazos
Arms adjustment

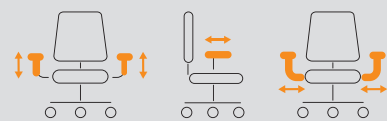

Assise réglable en profondeur et synchrone
Asiento regulable en profundidad y sincro
Seat depth adjustment and syncro mechanism

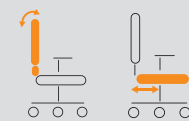

| SIÈGE OPÉRATIF

| OPERATIVA

| TASK CHAIR



Accoudoirs 2D ou 3D en option.
Brazos opcionales con
regulación 3D.
Optional 3D adjustable arms.



Roulettes pour sol dur
optionnelles.
Ruedas blandas opcionales.
Optional soft wheels.



MODÈLES | VARIANTES | VERSIONS











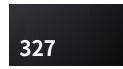



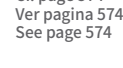

MODÈLE / VARIANTES / VERSIONS	TYPE / TIPO / TYPE	RÉFÉRENCE / REFERENCIA / CODE
 <p>Opératifs Operativa Task</p>	<p>Translation d'assise / Traslo / Seat depth adjustment</p> <p>Sans accoudoirs / Sin brazos / Without arms</p>	165.001.- - -
	<p>Translation d'assise / Traslo / Seat depth adjustment</p> <p>Accoudoirs réglables / Brazos regulables / Adjustable arms</p>	165.003.- - -
 <p>Opératifs Operativa Task</p>	<p>Sans accoudoirs / Sin brazos / Without arms</p>	165.031.- - -
	<p>Accoudoirs réglables / Brazos regulables / Adjustable arms</p>	165.033.- - -

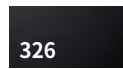
FINITIONS | ACABADOS | FINISHES

BASE + COQUE + ACCOUDOIRS
BASE + CARCASA + BRAZOS
BASE + SHELL + ARMS

DOSSIER EN RÉVILLE
RESPALDO EN REJILLA
MESH BACKREST

ASSISE: TISSU AU CHOIX
ASIENTO: TAPIZADO A ELEGIR
UPHOLSTERED SEAT

 Noir Negro Black	 327	 Noire Negro Black	 346	 Blanche Blanco White	 391	 Bleue Azul Blue	 344	 Grise Gris Grey
 Blanc Blanco White	 326	 Noire Negro Black	 366	 Blanche Blanco White	 365	 Bleue Azul Blue	 364	 Grise Gris Grey



Cf. page 574
Ver pagina 574
See page 574



M8

Les modèles de la série de siège M8, au design très actuel, existent dans de nombreuses versions. Ces composants sont de grande qualité et résistance lui assurant une longévité très importante.

Sillón operativo con diferentes alturas de respaldo con mecanismo sincro de 3 posiciones con un alto grado de funcionalidad y confort.

Executive and operative chair with multiple possibilities and configurations. A new range of seats that stands out for its design and comfort, along with some structural elements of high quality and durability.

SIÈGE OPÉRATIF
TAPISSÉ

SILLA OPERATIVA
TAPIZADA

UPHOLSTERED
TASK CHAIR

Réglable en hauteur
Regulación altura
Height adjustment

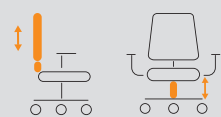

Assise réglable en profondeur et synchro
Asiento regulable en profundidad y sincro
Seat depth adjustment and synchro mechanism



Accoudoirs réglables
Regulación brazos
Arms adjustment

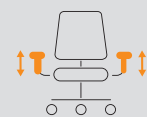



| SIÈGE DIRECTION | SILLA DIRECCIÓN | EXECUTIVE CHAIR



Tête réglable et tapissée.
El cabezal es un elemento que también se tapiza.
Headrest can be upholstered as well.

Tête réglable
Regulación cabezal
Headrest adjustment



Réglable en hauteur
Regulación altura
Height adjustment



Accoudoirs réglables
Regulación brazos
Arms adjustment



Dossier réglable
Inclinación respaldo
Backrest adjustment



|VISITEUR
|LUGE

|CONFIDENTE
|BALANCÍN

|CANTILEVER
|CHAIR



Ces sièges peuvent être tapissés en cuir, simili cuir ou en tissu.
Se puede tapizar con cualquier tejido del muestrario de telas.
Can be upholstered with leather, PU leather or fabric.



MODÈLES | VARIANTES | VERSIONS

MODÈLE / VARIANTES / VERSIONS	TYPE / TIPO / TYPE	RÉFÉRENCE / REFERENCIA / CODE
 Direction Dirección Executive	Accoudoirs réglables / Brazos regulables / Adjustable arms	108.329.001
 Opératifs Operativa Task	Sans accoudoirs / Sin brazos / Without arms Accoudoirs réglables / Brazos regulables / Adjustable arms	108.301.001 108.303.001
 Luge Balancín Cantilever	Accoudoirs fixes / Con brazos / Fixed arms	108.812.001

FINITIONS | ACABADOS | FINISHES

BASE
BASE
BASE

ASSISE ET DOSSIER: TISSU AU CHOIX
 ASIENTO Y RESPALDO: TAPIZADO A ELEGIR
 UPHOLSTERED SEAT AND BACKREST

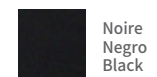

Noire
 Negro
 Black

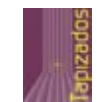

Cf. page 574
 Ver página 574
 See page 574



Iris

Le dossier en résille du siège IRIS est très confortable et disponible en coloris noir, rouge ou bleu. Cette série de sièges design est d'un grand confort.

La silla IRIS se caracteriza por su respaldo en malla muy confortable disponible en tres colores: negro, rojo o azul. Su punto fuerte es un asiento ancho realizado con una espuma que se adapta a todo tipo de usuario.

IRIS mesh backrest is very comfortable and it's available in three different finishes: black, red or blue. The seat is wide and its foam fits with any user.

| SIÈGE OPÉRATIF

| SILLA OPERATIVA

| TASK CHAIR



Réglable en hauteur
Regulación altura
Height adjustment



Dossier réglable
Inclinación respaldo
Backrest adjustment



Accoudoirs réglables
Regulación brazos
Arms adjustment

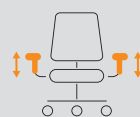



| SIÈGE OPÉRATIF

| SILLA OPERATIVA

| TASK CHAIR



| VISITEUR
| LUGE

| CONFIDENTE
| BALANCÍN

| CANTILEVER
| CHAIR















Assise uniquement en tissu noir.
Asiento tapizado exclusivamente en negro.
Only black upholstered seat.

MODÈLES | VARIANTES | VERSIONS

Base + Résille / Base + Rejilla / Base + Mesh

 Noire + noire / Negro + negro / Black + black
 Noire + rouge / Negro + roja / Black + red
 Noire + bleue / Negro + azul / Black + blue

MODÈLE / VARIANTES / VERSIONS	TYPE / TIPO / TYPE	RÉFÉRENCE / REFERENCIA / CODE			
 <p>Opératifs / Operativa / Task</p>	Sans accoudoirs / Sin brazos / Without arms				
		Siège démonté / silla desmontada / unassembled chair	122.301.329	122.301.389	122.301.399
		Siège monté / silla montada / assembled chair	122.301.321	122.301.381	122.301.391
 <p>Luge / Balancín / Cantilever</p>	Accoudoirs réglables / Brazos regulables / Adjustable arms				
		Siège démonté / silla desmontada / unassembled chair	122.303.329	122.303.389	122.303.399
		Siège monté / silla montada / assembled chair	122.303.321	122.303.381	122.303.391
 <p>Luge / Balancín / Cantilever</p>	Sans accoudoirs / Sin brazos / Without arms				
		Siège démonté / silla desmontada / unassembled chair	122.802.329	122.802.389	122.802.399
		Siège monté / silla montada / assembled chair	122.802.321	122.802.381	122.802.391



Elba

Le siège ELBA est un complément idéal de la série de direction SKYLINE. Choisissez la finition chromée ou argentée ainsi que le tissu qui s'adaptera le mieux à votre environnement de travail.

El sillón ELBA ofrece prestaciones de gama alta para adecuarse perfectamente en los despachos de dirección. Con la base en plata o cromada y la tela que mejor se integre en su entorno de trabajo.

ELBA chair is an exclusive chair for executive offices full of high quality details such as its base in chrome or silver finish or the wide range of fabrics and leather for upholster it.

| SIÈGE DE DIRECTION | SILLA DIRECCIÓN | EXECUTIVE CHAIR



Réglable en hauteur
Regulación altura
Height adjustment



Dossier réglable
Inclinación respaldo
Backrest adjustment



| VISITEUR
LUGE

| CONFIDENTE
BALANCÍN

| CANTILEVER
CHAIR

| Structure chromée ou argentée.
Estructura cromada o plata.
Chrome or silver frame.

| Accoudoirs fixes.
Con brazos fijos.
With "O-shape" upholstered fixed arms.



Réglable en hauteur
Regulación altura
Height adjustment



Dossier réglable
Inclinación respaldo
Backrest adjustment



| Siège très confortable.
Se caracteriza por su comodidad.
A very comfortable chair.







| SIÈGE OPÉRATIF

| SILLA OPERATIVA

| TASK CHAIR

MODÈLES | VARIANTES | VERSIONS

MODÈLE / VARIANTES / VERSIONS	TYPE / TIPO / TYPE	RÉFÉRENCE / REFERENCIA / CODE	
	Barre torsion avec accoudoirs fixes / Barra de torsión con brazos fijos / Knee-tilt mechanism with fixed arms	52.522.105	52.522.109
	Basculant avec accoudoirs fixes / Basculante con brazos fijos / Tilt mechanism with fixed arms	52.422.105	52.422.109
Direction Dirección Executive			
	Barre torsion avec accoudoirs fixes / Barra de torsión con brazos fijos / Knee-tilt mechanism with fixed arms	52.512.105	52.512.109
	Basculant avec accoudoirs fixes / Basculante con brazos fijos / Tilt mechanism with fixed arms	52.412.105	52.412.109
Opératifs Operativa Task			
	Luge Balancín Cantilever	52.812.105	52.812.109

FINITIONS | ACABADOS | FINISHES

BASE
BASE
BASE

Argentée
Plata
Silver
RAL 9006

Chromée
Cromado
Chrome

ASSISE ET DOSSIER: TISSU AU CHOIX
ASIENTO Y RESPALDO: TAPIZADO A ELEGIR
UPHOLSTERED SEAT AND BACKREST



Cf. page 574
Ver pagina 574
See page 574



Vic

Fauteuil de direction au design avant-gardiste.

Sillón direccional con un diseño clásico muy cómodo. Dispone de mecanismo sincro con ajuste de tensión y los brazos son fijos en acabado cromado.

Classic and comfortable executive chair with synchro mechanism with weight adjustment. Fixed arms with chrome details.



Réglable en hauteur
Regulación altura
Height adjustment

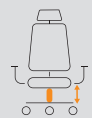

Dossier réglable
Inclinación respaldo
Backrest adjustment



| SIÈGE DE DIRECTION | SILLA DIRECCIÓN | EXECUTIVE CHAIR

| VISITEUR
| LUGE

| CONFIDENTE
| BALANCÍN

| CANTILEVER
| CHAIR

| Structure chromée.
| Con estructura balancín cromada.
| Chrome cantilever frame.



| Accoudoirs fixes et mécanisme synchrone.
| Silla con brazos fijos y mecanismo sincro.
| Synchro mechanism chair with fixed arms.

Réglable en hauteur
Regulación altura
Height adjustment



Dossier réglable
Inclinación respaldo
Backrest adjustment



| SIÈGE OPÉRATIF

| SILLA OPERATIVA

| TASK CHAIR

MODÈLES | VARIANTES | VERSIONS



Base + Tissu
Base + Tapizado
Base + Upholstered

Aluminium poli + Simili cuir noir
Aluminio pulido + PU negra
Polished aluminium + Black imitation leather

Aluminium poli + Cuir noir
Aluminio pulido + Piel negra
Polished aluminium + Black leather

Chromée + Simili cuir noir
Cromado + PU negra
Chrome + Black imitation leather

Chromée + Cuir noir
Cromado + Piel negra
Chrome + Black leather

MODÈLE / VARIANTES / VERSIONS	TYPE / TIPO / TYPE	RÉFÉRENCE / REFERENCIA / CODE						
 Direction Dirección Executive	Accoudoirs fixes / Brazos fijos / Fixed arms	<table border="0"> <tr> <td></td> <td>129.426.198</td> <td>129.426.188</td> </tr> <tr> <td>Siège démonté / silla desmontada / unassembled chair</td> <td>129.426.191</td> <td>129.426.181</td> </tr> </table>		129.426.198	129.426.188	Siège démonté / silla desmontada / unassembled chair	129.426.191	129.426.181
		129.426.198	129.426.188					
Siège démonté / silla desmontada / unassembled chair	129.426.191	129.426.181						
 Opératifs Operativa Task	Accoudoirs fixes / Brazos fijos / Fixed arms	<table border="0"> <tr> <td></td> <td>129.402.198</td> <td>129.402.188</td> </tr> <tr> <td>Siège démonté / silla desmontada / unassembled chair</td> <td>129.402.191</td> <td>129.402.181</td> </tr> </table>		129.402.198	129.402.188	Siège démonté / silla desmontada / unassembled chair	129.402.191	129.402.181
		129.402.198	129.402.188					
Siège démonté / silla desmontada / unassembled chair	129.402.191	129.402.181						
 Luge Balancín Cantilever	Accoudoirs fixes / Brazos fijos / Fixed arms	<table border="0"> <tr> <td></td> <td>129.802.191</td> <td>129.802.181</td> </tr> <tr> <td>4 Sièges démontés / 4 sillas desmontadas / 4 unassembled chairs</td> <td>129.802.194</td> <td>129.802.184</td> </tr> </table>		129.802.191	129.802.181	4 Sièges démontés / 4 sillas desmontadas / 4 unassembled chairs	129.802.194	129.802.184
		129.802.191	129.802.181					
4 Sièges démontés / 4 sillas desmontadas / 4 unassembled chairs	129.802.194	129.802.184						



Creta

Siège polyvalent disponible en modèle direction, opératif ou avec un piètement luge, très confortable.

Sillón polivalente que permite su uso direccional y operativo de altas prestaciones de confort.

CRETA chair is very comfortable and can either meet executive or office uses.

| SIÈGE DE DIRECTION | SILLA DIRECCIÓN | EXECUTIVE CHAIR



Réglable en hauteur
Regulación altura
Height adjustment



Accoudoirs réglables
Regulación brazos
Arms adjustment



Mécanisme Synchrone
Mecanismo Sincro
Synchro mechanism



| SIÈGE OPÉRATIF

| SILLA OPERATIVA

| TASK CHAIR

Accoudoirs réglables et mécanisme synchrone.
Brazos regulables y mecanismo sincro.
Synchro mechanism chair with adjustable arms.



Réglable en hauteur
Regulación altura
Height adjustment



Mécanisme Synchrone
Mecanismo Sincro
Synchro mechanism



Accoudoirs réglables
Regulación brazos
Arms adjustment

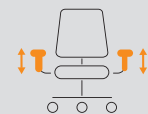

Sièges en simili cuir ou en cuir noir.
Puede estar tapizada con piel o polipiel.
Can be upholstered in leather or PU leather.

Cette série donnera une touche
élégante à votre bureau.
Ideal para ambientes elegantes.
Give and elegant touch to the office with
this chair.



VISITEUR
LUGE

CONFIDENTE
BALANCÍN

CANTILEVER
CHAIR



Visiteur luge avec structure chromée.
Con estructura balancín cromada.
Chrome cantilever frame.

MODÈLES | VARIANTES | VERSIONS

Base + Tissu
Base + Tapizado
Base + Upholstered



Aluminium poli + Simili cuir noir
Aluminio pulido + PU negra
Polished aluminium + Black imitation leather





Aluminium poli + Cuir noir
Aluminio pulido + Piel negra
Polished aluminium + Black leather



Chromée + Simili cuir noir
Cromado + PU negra
Chrome + Black imitation leather



Chromée + Cuir noir
Cromado + Piel negra
Chrome + Black leather

MODÈLE / VARIANTES / VERSIONS	TYPE / TIPO / TYPE	RÉFÉRENCE / REFERENCIA / CODE	
 Direction Dirección Executive	Accoudoirs réglables / Brazos regulables / Adjustable arms	<input checked="" type="checkbox"/>	<input checked="" type="checkbox"/>
	Siège démonté / silla desmontada / unassembled chair	128.327.198	128.327.188
	Siège monté / silla montada / assembled chair	128.327.191	128.327.181
<hr/>			
 Opératifs Operativa Task	Accoudoirs réglables / Brazos regulables / Adjustable arms	<input checked="" type="checkbox"/>	<input checked="" type="checkbox"/>
	Siège démonté / silla desmontada / unassembled chair	128.303.198	128.303.188
	Siège monté / silla montada / assembled chair	128.303.191	128.303.181
<hr/>			
 Luge Balancín Cantilever	Accoudoirs fixes / Brazos fijos / Fixed arms	<input checked="" type="checkbox"/>	<input checked="" type="checkbox"/>
	Siège monté / silla montada / assembled chair	128.802.191	128.802.181
	4 Sièges démontés / 4 sillas desmontadas / 4 unassembled chairs	128.802.194	128.802.184



Evole

Sièges polyvalents disponibles en plusieurs versions pour vos espaces de travail. Son design d'avant-garde le rend actuel mais sans renoncer pour autant à la fonctionnalité.

Sillas polivalentes que abarcan diferentes propuestas dentro de nuestro espacio de trabajo. Su diseño vanguardista le confiere una imagen actual sin renunciar por ello a su funcionalidad.

Multipurpose office chair that cover different proposals of the workspace. The avant-garde design confers an actual image without renouncing its functionality.

SIÈGE DE DIRECTION
TAPISSÉ

SILLA DIRECCIÓN
TAPIZADA

UPHOLSTERED
EXECUTIVE CHAIR

Réglable en hauteur
Regulación altura
Height adjustment

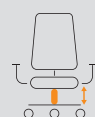

Dossier réglable
Inclinación respaldo
Backrest adjustment



SIÈGE DE
DIRECTION
AVEC RÉSILLE

DIRECCIÓN
CON REJILLA

MESH
EXECUTIVE
CHAIR

SIÈGE AVEC
RÉSILLE

SILLA CON
REJILLA

MESH SWIVEL
CHAIR



Réglable en hauteur
Regulación altura
Height adjustment



Résille blanche ou noire.
Rejilla disponible en blanco o negro.
Black or white mesh.





SIÈGE
PIVOTANT
TAPISSÉ

GIRATORIA
TAPIZADA
CON TOPES





UPHOLSTERED
SWIVEL
CHAIR

Accoudoirs chromés.
Brazos cromados fijos.
With chrome fixed arms.



MODÈLES | VARIANTES | VERSIONS

Base Chromée / Base Cromado / Chrome
 Tissu ou résille / Tapizado o rejilla / Uphostered or mesh
 Noir/ Negro / Black
 Blanc/che / Blanco / White

MODÈLE / VARIANTES / VERSIONS	TYPE / TIPO / TYPE	RÉFÉRENCE / REFERENCIA / CODE	
	Assise et dossier en tissu / Asiento y respaldo tapizados / Uphostered seat and backrest	131.422.199	131.422.099
	Assise et dossier en résille / Asiento y respaldo en rejilla / Mesh seat and backrest	131.422.329	131.422.089
Direction Dirección Executive			
	Assise et dossier en tissu / Asiento y respaldo tapizados / Uphostered seat and backrest	131.802.191	131.802.091
	Assise et dossier en résille / Asiento y respaldo en rejilla / Mesh seat and backrest	131.802.321	131.802.081
Base pyramidale plate sur patins Giratoria base plana con topes Flat crossed base with glides			



MORK

Au design universel italien, les chaises MORK appartiennent à la famille Contract. Les points forts de cette série sont une grande variété de couleurs et de structures qui permettent de répondre à vos besoins les plus exigeants. Monocoque large aux lignes droites et dossier courbe. MORK est complémentaire de MINDY.

El diseño italiano es un referente universal. Esta serie forma parte de la familia Contract en la que la variedad de colores y estructuras es el punto fuerte para poder adaptarse al máximo a todas las opciones donde se requiera un mobiliario de estas características. MORK es la pareja ideal de MINDY. Su monocarcasa es ancha y de formas lineales.

Italian design is a universal referral. This range belong to Contract chairs. A wide range of colors and frames are available to reach the most demanding expectation of the customer. MORK is MINDY fiancé. Its shell is wide and with straight lines.

EMPILABLE / APILABLE / STACKABLE



CHAISE
PIÈTEMENT
TRAÎNEAU

SILLA CON
ESTRUCTURA
PATÍN

SLED FRAME
CHAIR

Les finitions des structures 4 pieds
et traîneaux peuvent être blanches,
graphites ou chromées.

La estructura de 4 patas o patín puede ser
en acabado blanco, grafito o cromado.

Four legs or sled frame can be in white,
graphite or chrome finish.



BASE GIRATOIRE
PYRAMIDALE
SUR PATINS

GIRATORIA
PIRAMIDAL
CON TOPES

PYRAMIDAL
SWIVEL CHAIR
WITH GLIDES

CHAISE GIRATOIRE
SUR ROULETTES

GIRATORIA
CON RUEDAS

SWIVEL CHAIR
WITH WHEELS

Assise avec placet tapissé.
El asiento puede tapizarse.
Upholstered seat available.



Bases pyramidales et plates en aluminium poli. Chaise pivotante à 360° avec un système de retour automatique.

Tanto la base plana como la piramidal son de aluminio pulido con sistema autoretorno y rotación de 360°.

Polished aluminium swivel bases have 360° self-rotation system.



BASE GIRATOIRE
PLATE SUR PATINS

GIRATORIA
PLANA CON
TOPES

4-STAR SWIVEL
CHAIR WITH GLIDES



Selon la finition de la structure, le bouton décoratif du dossier sera blanc, graphite ou bleu.

El botón decorativo del respaldo puede ser blanco, grafito o azul y es muy útil para colgar objetos que así lo requieran.

The decorative bottom of the backrest is available in white, graphite or blue finishes and it's very useful for hanging objects.

Réglage en hauteur
Regulación altura
Height adjustment





| CHAISE 4 PIEDS





| SILLA CON 4 PATAS



| 4 LEGS CHAIR



| Empilable jusqu'à 6 unités.
| Apilable hasta 6 unidades.
| Stackable up to 6 chairs.

MODÈLES | VARIANTES | VERSIONS

MODÈLE / VARIANTES / VERSIONS	TYPE / TIPO / TYPE	RÉFÉRENCE / REFERENCIA / CODE		
	Assise et dossier: en polypropylène Asiento y respaldo: en polipropileno Polypropylene seat and backrest	 Blanche + blanc Blanco + blanco White + white	 Graphite + graphite Grafito + grafito Graphite + graphite	 Chromée + bleu Cromado + azul Chrome + blue
		Assise: Tissu au choix. Dossier: en polypropylène Asiento: Tapizado a elegir. Respaldo: en polipropileno Upholstered seat. Polypropylene backrest	157.271.---	157.371.---
Chaise 4 pieds Silla de 4 patas 4 legs				

	Assise et dossier: en polypropylène Asiento y respaldo: en polipropileno Polypropylene seat and backrest	157.291.---	157.391.---	157.491.---
		Assise: Tissu au choix. Dossier: en polypropylène Asiento: Tapizado a elegir. Respaldo: en polipropileno Upholstered seat. Polypropylene backrest	157.291.---	157.391.---
Siège pieds traîneau Sillas patin Sled frame				

FINITIONS | ACABADOS | FINISHES

POLYPROPYLÈNE / POLIPROPILENO / POLYPROPYLENE

241	Marron Marrón Beige	281	Graphite Grafito Graphite	251	Violet Violeta Violet	221	Bleu clair Azul claro Light blue	271	Blanc Blanco White
231	Vert clair Verde claro Light green	201	Orange Naranja Orange						



POLYPROPYLÈNE POLIPROPILENO POLYPROPYLENE



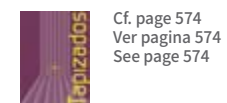

841	Marron Marrón Beige	881	Graphite Grafito Graphite	851	Violet Violeta Violet
821	Bleu clair Azul claro Light blue	871	Blanc Blanco White	831	Vert clair Verde claro Light green
801	Orange Naranja Orange				

ASSISE: TISSU AU CHOIX ASIENTO: TAPIZADO A ELEGIR UPHOLSTERED SEAT



Cf. page 574
Ver pagina 574
See page 574

MODÈLE / VARIANTES / VERSIONS	TYPE / TIPO / TYPE	RÉFÉRENCE / REFERENCIA / CODE
	Assise et dossier: en polypropylène Asiento y respaldo: en polipropileno Polypropylene seat and backrest	 Aluminium + bleu Aluminio + azul Aluminium + blue
		Assise: Tissu au choix. Dossier: en polypropylène Asiento: Tapizado a elegir. Respaldo: en polipropileno Upholstered seat. Polypropylene backrest
Giratoire sur roulettes Giratoria con ruedas Swivel base with wheels		

	Assise et dossier: en polypropylène Asiento y respaldo: en polipropileno Polypropylene seat and backrest	 Pyramidale / Piramidal / Pyramidal	 Plate / Plana / 4 Stars
		Assise: Tissu au choix. Dossier: en polypropylène Asiento: Tapizado a elegir. Respaldo: en polipropileno Upholstered seat. Polypropylene backrest	157.521.---
Siège giratoire sur patins Silla giratoria con conteras Swivel base with glides			

FINITIONS | ACABADOS | FINISHES

POLYPROPYLÈNE / POLIPROPILENO / POLYPROPYLENE

241	Marron Marrón Beige	281	Graphite Grafito Graphite	251	Violet Violeta Violet	221	Bleu clair Azul claro Light blue	271	Blanc Blanco White
231	Vert clair Verde claro Light green	201	Orange Naranja Orange						

POLYPROPYLÈNE POLIPROPILENO POLYPROPYLENE

841	Marron Marrón Beige	881	Graphite Grafito Graphite	851	Violet Violeta Violet
821	Bleu clair Azul claro Light blue	871	Blanc Blanco White	831	Vert clair Verde claro Light green
801	Orange Naranja Orange				

ASSISE: TISSU AU CHOIX ASIENTO: TAPIZADO A ELEGIR UPHOLSTERED SEAT



Cf. page 574
Ver pagina 574
See page 574

MINDY

De design universel italien, les chaises MINDY appartiennent à la famille Contract. Les points forts de cette série sont une grande variété de couleurs et de structures qui permettent de répondre à vos besoins les plus exigeants. Monocoque aux formes arrondies et munie d'un dossier étroit. MINDY est complémentaire de MORK.

El diseño italiano es un referente universal. Esta serie forma parte de la familia Contract en la que la variedad de colores y estructuras es el punto fuerte para poder adaptarse al máximo a todas las opciones donde se requiera un mobiliario de estas características. MINDY es la pareja ideal de MORK. Su monocoque tiene formas más redondeadas y el respaldo es más estrecho.

Italian design is a universal referral. This range belong to Contract chairs. A wide range of colors and frames are available to reach the most demanding expectation of the customer. MINDY is MORK'S fiancée. Its shell is more tight and round.

EMPILABLE / APILABLE / STACKABLE



CHAISE
PIÈTEMENT
TRAÎNEAU

SILLA CON
ESTRUCTURA
PATÍN

SLED FRAME
CHAIR

Empilable jusqu'à 6 unités.
Apilable hasta 6 unidades.
Stackable up to 6 chairs.



CHAISE GIRATOIRE
SUR ROULETTES

GIRATORIA
CON RUEDAS

SWIVEL CHAIR
WITH WHEELS

Réglage en hauteur
Regulación altura
Height adjustment



Selon la finition de la structure, le bouton décoratif du dossier sera blanc, graphite ou bleu. El botón decorativo del respaldo puede ser blanco, grafito o azul y es muy útil para colgar objetos que así lo requieran. The decorative bottom of the backrest is available in white, graphite or blue finishes and it's very useful for hanging objects.



Assise avec placet tapissé. El asiento puede tapizarse. Upholstered seat available.



BASE GIRATOIRE
PLATE SUR PATINS

GIRATORIA
PLANA CON
TOPES

4-STAR SWIVEL
CHAIR WITH GLIDES

BASE GIRATOIRE
PYRAMIDALE
SUR PATINS

GIRATORIA
PIRAMIDAL
CON TOPES

PYRAMIDAL
SWIVEL CHAIR
WITH GLIDES

Bases pyramidales et plates en aluminium poli. Chaise pivotante à 360° avec un système de retour automatique. Tanto la base plana como la piramidal son de aluminio pulido con sistema autoretorno y rotación de 360°. Polished aluminium swivel bases have 360° self-rotation system.

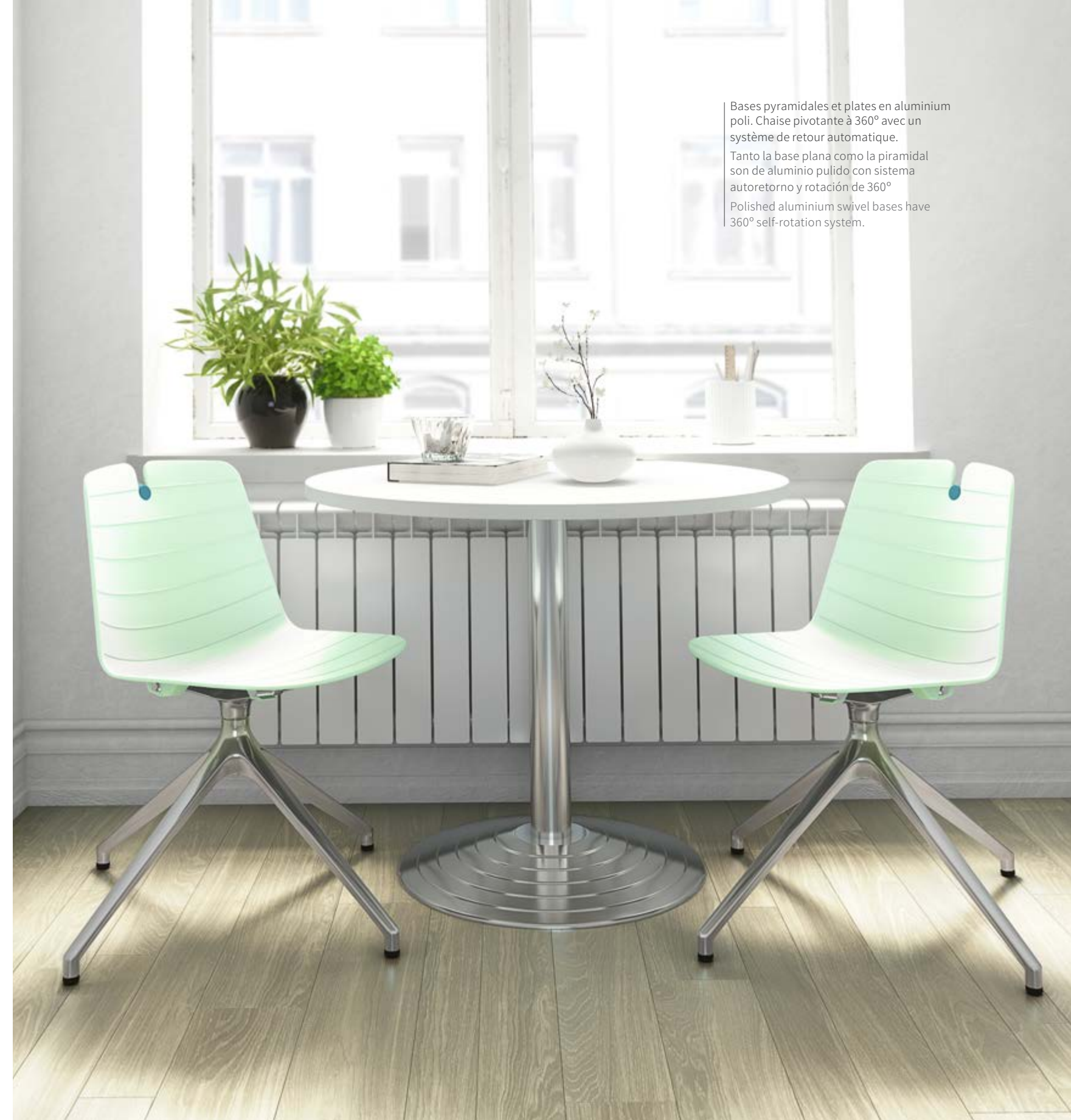



| CHAISE 4 PIEDS

| SILLA CON 4 PATAS

| 4 LEGS CHAIR



Les finitions des structures 4 pieds et traîneau peuvent être blanches, graphites ou chromées.
La estructura de 4 patas o patín puede ser en acabado blanco, grafito o cromado.
Four legs or sled frame can be in white, graphite or chrome finish.









MODÈLES | VARIANTES | VERSIONS

Structure + Bouton dossier
Estructura + Botón respaldo
Frame + Backrest button









Blanche + blanc
Blanco + blanco
White + white

Graphite + graphite
Grafito + grafito
Graphite + graphite

Chromée + bleu
Cromado + azul
Chrome + blue

MODÈLE / VARIANTES / VERSIONS	TYPE / TIPO / TYPE	RÉFÉRENCE / REFERENCIA / CODE		
	Assise et dossier: en polypropylène Asiento y respaldo: en polipropileno Polypropylene seat and backrest			
		158.271.-.-	158.371.-.-	158.471.-.-
	Assise: Tissu au choix. Dossier: en polypropylène Asiento: Tapizado a elegir. Respaldo: en polipropileno Upholstered seat. Polypropylene backrest			
		158.271.-.-	158.371.-.-	158.471.-.-

Chaise 4 pieds
Silla de 4 patas
4 legs

	Assise et dossier: en polypropylène Asiento y respaldo: en polipropileno Polypropylene seat and backrest			
		158.291.-.-	158.391.-.-	158.491.-.-
	Assise: Tissu au choix. Dossier: en polypropylène Asiento: Tapizado a elegir. Respaldo: en polipropileno Upholstered seat. Polypropylene backrest			
		158.291.-.-	158.391.-.-	158.491.-.-

Siège pieds traîneau
Sillas patin
Sled base

FINITIONS | ACABADOS | FINISHES

POLYPROPYLÈNE / POLIPROPILENO / POLYPROPYLENE





241	Marron Marrón Beige	281	Graphite Grafito Graphite	251	Violet Violeta Violet	221	Bleu clair Azul claro Light blue	271	Blanc Blanco White
231	Vert clair Verde claro Light green	201	Orange Naranja Orange						

POLYPROPYLÈNE
POLIPROPILENO
POLYPROPYLENE

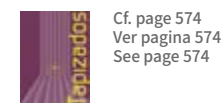





841	Marron Marrón Beige	881	Graphite Grafito Graphite	851	Violet Violeta Violet
821	Bleu clair Azul claro Light blue	871	Blanc Blanco White	831	Vert clair Verde claro Light green
801	Orange Naranja Orange				

ASSISE: TISSU AU CHOIX
ASIENTO: TAPIZADO A ELEGIR
SEAT: UPHOLSTERED



MODÈLE / VARIANTES / VERSIONS	TYPE / TIPO / TYPE	RÉFÉRENCE / REFERENCIA / CODE	
	Assise et dossier: en polypropylène Asiento y respaldo: en polipropileno Polypropylene seat and backrest		
		158.511.-.-	
	Assise: Tissu au choix. Dossier: en polypropylène Asiento: Tapizado a elegir. Respaldo: en polipropileno Upholstered seat. Polypropylene backrest		
		158.511.-.-	

Giratoire sur roulettes
Giratoria con ruedas
Swivel base with wheels

	Assise et dossier: en polypropylène Asiento y respaldo: en polipropileno Polypropylene seat and backrest		Pyramidale / Piramidal / Pyramidal		Plate / Plana / 4 Stars
		158.521.-.-		158.501.-.-	
	Assise: Tissu au choix. Dossier: en polypropylène Asiento: Tapizado a elegir. Respaldo: en polipropileno Upholstered seat. Polypropylene backrest				
		158.521.-.-		158.501.-.-	

Siège giratoire sur patins
Silla giratoria con conteras
Swivel base with glides

FINITIONS | ACABADOS | FINISHES

POLYPROPYLÈNE / POLIPROPILENO / POLYPROPYLENE

241	Marron Marrón Beige	281	Graphite Grafito Graphite	251	Violet Violeta Violet	221	Bleu clair Azul claro Light blue	271	Blanc Blanco White
231	Vert clair Verde claro Light green	201	Orange Naranja Orange						

POLYPROPYLÈNE
POLIPROPILENO
POLYPROPYLENE

841	Marron Marrón Beige	881	Graphite Grafito Graphite	851	Violet Violeta Violet
821	Bleu clair Azul claro Light blue	871	Blanc Blanco White	831	Vert clair Verde claro Light green
801	Orange Naranja Orange				

ASSISE: TISSU AU CHOIX
ASIENTO: TAPIZADO A ELEGIR
SEAT: UPHOLSTERED

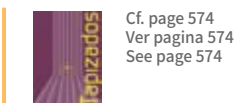

FRILL

Au design universel italien, les chaises FRILL appartiennent à la famille Contract. Les points forts de cette série sont une grande variété de couleurs et de structures qui permettent de répondre à vos besoins les plus exigeants. Monocoque avec accoudoirs intégrés, FRILL est la soeur jumelle de NO-FRILL.

El diseño italiano es un referente universal. Esta serie forma parte de la familia Contract en la que la variedad de colores y estructuras es el punto fuerte para poder adaptarse al máximo a todas las opciones donde se requiera un mobiliario de estas características.

FRILL es la melliza de NO-FRILL.

Su monocarcasa plástica se caracteriza por tener los brazos integrados.

Italian design is a universal referral. This range belong to Contract chairs. A wide range of colors and frames are available to reach the most demanding expectation of the customer.

FRILL is NO-FRILL's sister. Its plastic shell has integrated arms.

EMPILABLE / APILABLE / STACKABLE



CHAISE GIRATOIRE
SUR ROULETTES

GIRATORIA
CON RUEDAS

SWIVEL CHAIR
WITH WHEELS

Réglage en hauteur
Regulación altura
Height adjustment



Assise avec placet tapissé.
El asiento puede tapizarse.
Upholstered seat available.

CHAISE
PIÈTEMENT
TRAÎNEAU

SILLA CON
ESTRUCTURA
PATÍN

SLED FRAME
CHAIR



Les finitions des structures 4 pieds et traîneau peuvent être blanches, graphites ou chromées.
La estructura de 4 patas o patín puede ser en acabado blanco, grafito o cromado.
4 legs or sled frame can be in white, graphite or chrome finish.

CHAISE 4 PIEDS

SILLA CON 4 PATAS

4 LEGS CHAIR

Empilable jusqu'à 6 unités.
Apilable hasta 6 unidades.
Stackable up to 6 chairs.



BASE GIRATOIRE
PYRAMIDALE
SUR PATINS

GIRATORIA
PIRAMIDAL
CON TOPES

PYRAMIDAL
SWIVEL CHAIR
WITH GLIDES



Bases pyramidales ou plates en aluminium poli. Chaise pivotante à 360° avec un système de retour automatique.

Tanto la base plana como la piramidal son de aluminio pulido con sistema autoretorno y rotación de 360°.

Polished aluminium swivel bases have 360° self-rotation system.

Monocoque avec accoudoirs intégrés.
Tiene los brazos incluidos en la monocarcasa.
Arms are integrated with the shell.



BASE GIRATOIRE
PLATE SUR PATINS

GIRATORIA
PLANA CON
TOPES



4-STAR SWIVEL
CHAIR WITH
GLIDES

MODÈLES | VARIANTES | VERSIONS

MODÈLE / VARIANTES / VERSIONS	TYPE / TIPO / TYPE	RÉFÉRENCE / REFERENCIA / CODE		
	Assise et dossier: en polypropylène Asiento y respaldo: en polipropileno Polypropylene seat and backrest	 159.272.---	 159.372.---	 159.472.---
	Assise: Tissu au choix. Dossier: en polypropylène Asiento: Tapizado a elegir. Respaldo: en polipropileno Upholstered seat. Polypropylene backrest	159.272.---	159.372.---	159.472.---

Structure Estructura Frame  Blanche Blanco White  Graphite Grafito Graphite  Chromée Cromado Chrome



Chaise 4 pieds
Silla de 4 patas
4 legs

	Assise et dossier: en polypropylène Asiento y respaldo: en polipropileno Polypropylene seat and backrest	159.292.---	159.392.---	159.492.---
	Assise: Tissu au choix. Dossier: en polypropylène Asiento: Tapizado a elegir. Respaldo: en polipropileno Upholstered seat. Polypropylene backrest	159.292.---	159.392.---	159.492.---







Siège pieds traîneau
Sillas patin
Sled frame

FINITIONS | ACABADOS | FINISHES

POLYPROPYLÈNE / POLIPROPILENO / POLYPROPYLENE

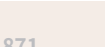
 341	Bleu clair Azul claro Light blue	 281	Graphite Grafito Graphite	 271	Blanc Blanco White	 201	Orange Naranja Orange	 291	Bleu foncé Azul claro Dark blue
 241	Marron Marrón Beige	 211	Jaune Amarillo Yellow						



POLYPROPYLÈNE POLIPROPILENO POLYPROPYLENE

 541	Bleu clair Azul claro Light blue	 881	Graphite Grafito Graphite	 871	Blanc Blanco White
 801	Orange Naranja Orange	 891	Bleu foncé Azul claro Dark blue	 841	Marron Marrón Beige
 811	Jaune Amarillo Yellow				

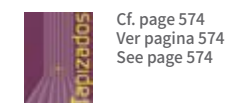
ASSISE: TISSU AU CHOIX ASIENTO: TAPIZADO A ELEGIR UPHOLSTERED SEAT







Cf. page 574
Ver pagina 574
See page 574

MODÈLE / VARIANTES / VERSIONS	TYPE / TIPO / TYPE	RÉFÉRENCE / REFERENCIA / CODE
	Assise et dossier: en polypropylène Asiento y respaldo: en polipropileno Polypropylene seat and backrest	 159.512.---
	Assise: Tissu au choix. Dossier: en polypropylène Asiento: Tapizado a elegir. Respaldo: en polipropileno Upholstered seat. Polypropylene backrest	159.512.---

Structure Estructura Frame  Aluminium Aluminio Aluminium

Giratoire sur roulettes
Giratoria con ruedas
Swivel base with wheels

	Assise et dossier: en polypropylène Asiento y respaldo: en polipropileno Polypropylene seat and backrest	 159.522.---	 159.502.---
	Assise: Tissu au choix. Dossier: en polypropylène Asiento: Tapizado a elegir. Respaldo: en polipropileno Upholstered seat. Polypropylene backrest	159.522.---	159.502.---







Siège giratoire sur patins
Silla giratoria con conteras
Swivel base with glides

FINITIONS | ACABADOS | FINISHES

POLYPROPYLÈNE / POLIPROPILENO / POLYPROPYLENE

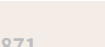
 341	Bleu clair Azul claro Light blue	 281	Graphite Grafito Graphite	 271	Blanc Blanco White	 201	Orange Naranja Orange	 291	Bleu foncé Azul claro Dark blue
 241	Marron Marrón Beige	 211	Jaune Amarillo Yellow						

POLYPROPYLÈNE POLIPROPILENO POLYPROPYLENE

 541	Bleu clair Azul claro Light blue	 881	Graphite Grafito Graphite	 871	Blanc Blanco White
 801	Orange Naranja Orange	 891	Bleu foncé Azul claro Dark blue	 841	Marron Marrón Beige
 811	Jaune Amarillo Yellow				

ASSISE: TISSU AU CHOIX ASIENTO: TAPIZADO A ELEGIR UPHOLSTERED SEAT

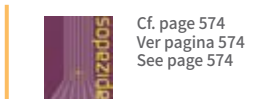

Cf. page 574
Ver pagina 574
See page 574

NO-FRILL

Au design universel italien, les chaises NO-FRILL appartiennent à la famille Contract. Les points forts de cette série sont une grande variété de couleurs et de structures qui permettent de répondre à vos besoins les plus exigeants.

Monocoque sans accoudoirs.

NO-FRILL est la soeur jumelle de FRILL.

El diseño italiano es un referente universal. Esta serie forma parte de la familia Contract en la que la variedad de colores y estructuras es el punto fuerte para poder adaptarse al máximo a todas las opciones donde se requiera un mobiliario de estas características.

Su monocarcasa plástica no tiene brazos.

Italian design is a universal referral. This range belong to Contract chairs. A wide range of colors and frames are available to reach the most demanding expectation of the costumer.

Its plastic shell doesn't have arms.

EMPILABLE / APILABLE / STACKABLE



CHAISE
PIÈTEMENT
TRAÎNEAU

SILLA CON
ESTRUCTURA
PATÍN

SLED FRAME
CHAIR



Empilable jusqu'à 6 unités.
Apilable hasta 6 unidades.
Stackable up to 6 chairs.

BASE GIRATOIRE
PLATE SUR PATINS

GIRATORIA
PLANA CON
TOPES

4-STAR SWIVEL
CHAIR WITH
GLIDES



Bases pyramidales ou plates en aluminium poli. Chaise pivotante à 360° avec un système de retour automatique.
Tanto la base plana como la piramidal son de aluminio pulido con sistema autoretorno y rotación de 360°.
Polished aluminium swivel bases have 360° self-rotation system.



Réglage en hauteur
Regulación altura
Height adjustment

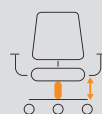

CHAISE GIRATOIRE
SUR ROULETTES

GIRATORIA
CON RUEDAS

SWIVEL CHAIR
WITH WHEELS

BASE GIRATOIRE
PYRAMIDALE
SUR PATINS

GIRATORIA
PIRAMIDAL
CON TOPES

PYRAMIDAL
SWIVEL CHAIR
WITH GLIDES

Assise avec placet tapissé.
El asiento puede tapizarse.
Upholstered seat available.





| CHAISE 4 PIEDS



| SILLA CON 4 PATAS

| 4 LEGS CHAIR





Les accoudoirs sont intégrés à la structure.
No tiene los brazos incluidos en la monocarcasa pero sí que puede tenerlos integrados en la estructura.
The shell has no arms but frame can has integrated metal fixed arms.

MODÈLES | VARIANTES | VERSIONS

MODÈLE / VARIANTES / VERSIONS	TYPE / TIPO / TYPE	RÉFÉRENCE / REFERENCIA / CODE			
	Assise et dossier: en polypropylène Asiento y respaldo: en polipropileno Polypropylene seat and backrest	Sans accoudoirs / Sin brazos / Without arms Accoudoirs fixes / Con brazos / Fixed arms	160.271... 160.272... 160.271... 160.272...	160.371... 160.372... 160.371... 160.372...	160.471... 160.472... 160.471... 160.472...
	Assise: Tissu au choix. Dossier: en polypropylène Asiento: Tapizado a elegir. Respaldo: en polipropileno Upholstered seat. Polypropylene backrest	Sans accoudoirs / Sin brazos / Without arms Accoudoirs fixes / Con brazos / Fixed arms	160.271... 160.272... 160.271... 160.272...	160.371... 160.372... 160.371... 160.372...	160.471... 160.472... 160.471... 160.472...

Structure Estructura Frame Blanche Blanco White Graphite Grafito Graphite Chromée Cromado Chrome

Chaise 4 pieds
Silla de 4 patas
4 legs

	Assise et dossier: en polypropylène Asiento y respaldo: en polipropileno Polypropylene seat and backrest		160.291... 160.291... 160.291... 160.291...	160.391... 160.391... 160.391... 160.391...	160.491... 160.491... 160.491... 160.491...
	Assise: Tissu au choix. Dossier: en polypropylène Asiento: Tapizado a elegir. Respaldo: en polipropileno Upholstered seat. Polypropylene backrest		160.291... 160.291... 160.291... 160.291...	160.391... 160.391... 160.391... 160.391...	160.491... 160.491... 160.491... 160.491...

Siège pieds traîneau
Sillas patin
Sled frame

FINITIONS | ACABADOS | FINISHES

POLYPROPYLÈNE / POLIPROPILENO / POLYPROPYLENE

341	Bleu clair Azul claro Light blue	281	Graphite Grafito Graphite	271	Blanc Blanco White	201	Orange Naranja Orange	291	Bleu foncé Azul claro Dark blue
241	Marron Marrón Beige	211	Jaune Amarillo Yellow						



POLYPROPYLÈNE POLIPROPILENO POLYPROPYLENE

541	Bleu clair Azul claro Light blue	881	Graphite Grafito Graphite	871	Blanc Blanco White	801	Orange Naranja Orange	891	Bleu foncé Azul claro Dark blue	841	Marron Marrón Beige	811	Jaune Amarillo Yellow
-----	--	-----	---------------------------------	-----	--------------------------	-----	-----------------------------	-----	---------------------------------------	-----	---------------------------	-----	-----------------------------

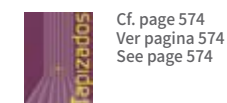
ASSISE: TISSU AU CHOIX ASIENTO: TAPIZADO A ELEGIR UPHOLSTERED SEAT





Cf. page 574
Ver página 574
See page 574

MODÈLE / VARIANTES / VERSIONS	TYPE / TIPO / TYPE	RÉFÉRENCE / REFERENCIA / CODE
	Assise et dossier: en polypropylène Asiento y respaldo: en polipropileno Polypropylene seat and backrest	160.511... 160.511... 160.511... 160.511...
	Assise: Tissu au choix. Dossier: en polypropylène Asiento: Tapizado a elegir. Respaldo: en polipropileno Upholstered seat. Polypropylene backrest	160.511... 160.511... 160.511... 160.511...

Structure Estructura Frame Aluminium Aluminio Aluminium

Giratoire sur roulettes
Giratoria con ruedas
Swivel base with wheels

	Assise et dossier: en polypropylène Asiento y respaldo: en polipropileno Polypropylene seat and backrest	Pyramidale / Piramidal / Pyramidal 160.521... 160.521... 160.521... 160.521...	Plate / Plana / 4 Stars 160.501... 160.501... 160.501... 160.501...
	Assise: Tissu au choix. Dossier: en polypropylène Asiento: Tapizado a elegir. Respaldo: en polipropileno Upholstered seat. Polypropylene backrest	160.521... 160.521... 160.521... 160.521...	160.501... 160.501... 160.501... 160.501...

Siège giratoire sur patins
Silla giratoria con conteras
Swivel base with glides

FINITIONS | ACABADOS | FINISHES

POLYPROPYLÈNE / POLIPROPILENO / POLYPROPYLENE

341	Bleu clair Azul claro Light blue	281	Graphite Grafito Graphite	271	Blanc Blanco White	201	Orange Naranja Orange	291	Bleu foncé Azul claro Dark blue
241	Marron Marrón Beige	211	Jaune Amarillo Yellow						

POLYPROPYLÈNE POLIPROPILENO POLYPROPYLENE

541	Bleu clair Azul claro Light blue	881	Graphite Grafito Graphite	871	Blanc Blanco White	801	Orange Naranja Orange	891	Bleu foncé Azul claro Dark blue	841	Marron Marrón Beige	811	Jaune Amarillo Yellow
-----	--	-----	---------------------------------	-----	--------------------------	-----	-----------------------------	-----	---------------------------------------	-----	---------------------------	-----	-----------------------------

ASSISE: TISSU AU CHOIX ASIENTO: TAPIZADO A ELEGIR UPHOLSTERED SEAT



Cf. page 574
Ver página 574
See page 574

LOOLA

Au design universel italien, les chaises LOOLA appartiennent à la famille Contract. Les points forts de cette série sont une grande variété de couleurs et de structures qui permettent de répondre à vos besoins les plus exigeants. La chaise LOOLA est polyvalente, légère et fonctionnelle.

El diseño italiano es un referente universal. Esta serie forma parte de la familia Contract en la que la variedad de colores es el punto fuerte para poder adaptarse al máximo a todas las opciones donde se requiera un mobiliario de estas características. La silla LOOLA es versátil, ligera y funcional.

Italian design is a universal referral. This range belong to Contract chairs. A wide range of colors is available to reach the most demanding expectation of the costumer. LOOLA chair is versatile, light and functional.

EMPILABLE / APILABLE / STACKABLE



CHAISE VISITEUR
4 PIEDS

SILLA CON 4 PATAS

4 LEGS CHAIR



Structure blanche ou chromée.
La estructura puede ser blanca o cromada.
White or chrome frame.



MODÈLES | VARIANTES | VERSIONS

Carter extérieur assise et dossier
Embellecedor asiento y respaldo
Outer shell

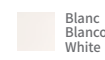

Blanc
Blanco
White

Structure
Estructura
Frame



Blanche
Blanco
White



Chromée
Cromado
Chrome

MODÈLE / VARIANTES / VERSIONS

RÉFÉRENCE / REFERENCIA / CODE



Chaise 4 pieds
Silla de 4 patas
4 legs



161.271.-.-



161.471.-.-

FINITIONS | ACABADOS | FINISHES

POLYPROPYLÈNE / POLIPROPILENO / POLYPROPYLENE

331 Turquoise Turquesa Turquoise	361 Vert clair Verde claro Light green	251 Violet Violeta Violet	281 Graphite Grafito Graphite	341 Bleu clair Azul claro Light blue
301 Pêche Melocotón Peach	511 Moutarda Mostaza Moustaard	211 Jaune Amarillo Yellow	551 Vert Verde Green	321 Bleu foncé Azul claro Dark blue



Nut

Suivant les tendances nordiques les plus actuelles, la chaise NUT se compose d'une assise monocoque et d'une structure 4 pieds en bois naturel. Cette série se complète avec des tabourets de même esprit.

Siguiendo de cerca la tendencia escandinava más actual, NUT está compuesta por una carcasa de plástico y patas de madera. La serie también cuenta con un taburete.

Following nordic trends, NUT chair has a plastic shell with wood legs. It can also match with the stool of the same range.

CHAISE 4 PIEDS
EN BOIS

SILLA DE
4 PATAS

4 LEGS
CHAIR



| TABOURET

| TABURETE

| STOOL



Le piètement traîneau du tabouret peut être en métal ou en bois naturel.
La estructura del taburete puede ser metálica o en haya natural.
Stool frame is available in metal or natural beech finishes.



MODÈLES | VARIANTES | VERSIONS

Base
Base
Base

Bois naturel
Madera natural
Natural wood

Chromée
Cromado
Chrome

MODÈLE / VARIANTES / VERSIONS	TYPE / TIPO / TYPE	RÉFÉRENCE / REFERENCIA / CODE
	4 U. / 4 U. / 4 chairs	Assise et dossier en polypropylène Asiento y respaldo en polipropileno Polypropylene seat and backrest 155.401.-.-
	4 U. / 4 U. / 4 chairs	Assise et dossier seulement en polypropylène blanc Asiento y respaldo en polipropileno blanco White polypropylene seat and backrest 155.601.274
	4 U. / 4 U. / 4 chairs	Assise et dossier en polypropylène Asiento y respaldo en polipropileno Polypropylene seat and backrest 155.671.-.-

Tabouret
Taburete
Stool

Chaise 4 pieds en bois
Silla de 4 patas
4 wood legs

FINITIONS | ACABADOS | FINISHES

POLYPROPYLÈNE / POLIPROPILENO / POLYPROPYLENE

214 Noir
Negro
Black

274 Blanc
Blanco
White

264 Gris
Gris
Grey

224 Bleu
Azul
Blue



Hole

Chaise de lignes nordiques avec un design unique où les formes arrondies de l'assise sont les protagonistes.

Sillón de estilo nórdico con un diseño particular donde resaltan las líneas del respaldo.

Nordic style seating with sinuous shapes for seat and backrest.

CHAISE TAPISSÉE
AVEC PIÈTEMENT
TRAÎNEAU

SILLA TAPIZADA
CON PATÍN

UPHOLSTERED
SLED CHAIR



CHAISE EN
POLYPROPYLÈNE
AVEC PIÈTEMENT
TRAÎNEAU

SILLA DE
POLIPROPILENO
CON PATÍN

POLYPROPYLENE
SLED CHAIR







Chaise originale sur structure traîneau chromée.
Un modelo de silla muy peculiar con estructura
patín cromada.
An original chair with chrome sled frame.



MODÈLES | VARIANTES | VERSIONS

Base
Base
Base

Chromée
Cromado
Chrome

MODÈLE / VARIANTES / VERSIONS	RÉFÉRENCE / REFERENCIA / CODE
 <p>Tissu Tapizado Upholstered</p> <p>2 U. / 2 U. / 2 chairs</p> <p>153.491.-.-</p>	
 <p>Polypropylène Polipropileno Polypropylene</p> <p>4 U. / 4 U. / 4 chairs</p> <p>153.491.-.-</p>	

Siège pieds traîneau
Sillas patin
Sled frame

FINITIONS | ACABADOS | FINISHES

ASSISE ET DOSSIER EN TISSU
ASIENTO Y RESPALDO TAPIZADOS
UPHOLSTERED SEAT AND BACKREST

142 Noir Negro Black	152 Vert Verde Green	162 Bleu Azul Blue	172 Rose Rosa Pink
-----------------------------------	-----------------------------------	---------------------------------	---------------------------------

ASSISE ET DOSSIER EN POLYPROPYLÈNE
ASIENTO Y RESPALDO POLIPROPILENO
POLYPROPYLENE SEAT AND BACKREST

214 Noir Negro Black	274 Blanc Blanco White	264 Gris Gris Grey	224 Bleu Azul Blue
-----------------------------------	-------------------------------------	---------------------------------	---------------------------------



Hop

Chaise visiteur très tendance. La structure et la coque son fabriquées avec des matériaux de grande qualité.

Un diseño moderno y actual realizado con materiales de calidad tanto para la monocarcasa como para la estructura. Sorprende el acabado de sus detalles cuidados al máximo.

A trendy chair manufactured with good quality materials for shell and frame and with amazing details.



CHAISE 4 PIEDS
EN BOIS

SILLA DE
4 PATAS

4 LEGS
CHAIR



CHAISE AVEC
PIÈTEMENT
TRAÎNEAU

SILLA DE
POLIPROPILENO
CON PATÍN

POLYPROPYLENE
SLED CHAIR



La structure peut être en 4 pieds en bois naturel ou en piètement traîneau chromé.
La estructura puede ser con 4 patas de madera o patín cromada.
Four wood legs or chrome sled frame.







MODÈLES | VARIANTES | VERSIONS

Base
Base
Base

Bois naturel
Madera natural
Natural wood

Chromée
Cromado
Chrome

MODÈLE / VARIANTES / VERSIONS	RÉFÉRENCE / REFERENCIA / CODE
 <p>Siège pieds traîneau Sillas patin Sled frame</p>	 <p>4 U. / 4 U. / 4 chairs</p> <p>154.492.-.-</p>
 <p>Chaise 4 pieds en bois Silla de 4 patas 4 wood legs</p>	 <p>4 U. / 4 U. / 4 chairs</p> <p>154.672.-.-</p>

FINITIONS | ACABADOS | FINISHES

POLYPROPYLÈNE / POLIPROPILENO / POLYPROPYLENE

214 Noir
Negro
Black

274 Blanc
Blanco
White

264 Gris
Gris
Grey

224 Bleu
Azul
Blue



Liner

Cette chaise aux formes contemporaines et aux très belles finitions, est parfaite pour l'équipement de salles d'attente, de halls, de bureaux ou de chambres d'hôtel.

Esta silla presenta muy buenos acabados y formas contemporáneas y atractivas, ideal para salas de espera, hoteles, habitaciones u oficinas.

This chair has good quality finishes and a contemporary and attractive shape. It's perfect for waiting areas, hotels, rooms or offices.

CHAISE 4 PIEDS
EN BOIS

SILLA DE
4 PATAS
DE MADERA

4 WOOD
LEGS CHAIR



CHAISE 4 PIEDS
MÉTALLIQUES

SILLA DE 4 PATAS
METÁLICAS

4 METAL
LEGS CHAIR



Structure 4 pieds disponible en bois naturel ou en métal.
La estructura de la silla está disponible en 4 patas de madera o metálicas.
Four metal or wood legs frame.



CHAISE 4 PIEDS
EN BOIS

SILLA DE
4 PATAS
DE MADERA

4 WOOD
LEGS CHAIR

MODÈLES | VARIANTES | VERSIONS

Base Base Bois naturel Madera natural Natural wood Chromée Cromado Chrome

MODÈLE / VARIANTES / VERSIONS	RÉFÉRENCE / REFERENCIA / CODE		
	Tissu Tapizado Upholstered	2 U. / 2 U. / 2 chairs	156.672.- - -
	Polypropylène Polipropileno Polypropylene	4 U. / 4 U. / 4 chairs	156.672.- - -
Chaise 4 pieds en bois Silla de 4 patas 4 wood legs			
	Polypropylène Polipropileno Polypropylene	4 U. / 4 U. / 4 chairs	156.472.- - -
Chaise 4 pieds Silla de 4 patas 4 chrome legs			

FINITIONS | ACABADOS | FINISHES

ASSISE ET DOSSIER EN TISSU
ASIENTO Y RESPALDO TAPIZADOS
UPHOLSTERED SEAT AND BACKREST

142 Noir Negro Black 152 Vert Verde Green 162 Bleu Azul Blue 172 Rose Rosa Pink

ASSISE ET DOSSIER EN POLYPROPYLÈNE
ASIENTO Y RESPALDO POLIPROPILENO
POLYPROPYLENE SEAT AND BACKREST

214 Noir Negro Black 274 Blanc Blanco White 264 Gris Gris Grey 224 Bleu Azul Blue



NEST

Au design universel italien, les fauteuils NEST appartiennent à la famille Contract. Les points forts de cette série sont une grande variété de couleurs et de structures qui permettent de répondre à vos besoins les plus exigeants. Une conception innovante et confortable sans oublier l'esthétique!

El diseño italiano es un referente universal. Esta serie forma parte de la familia Contract. El punto fuerte de NEST es la combinación de tapizados para adaptarse al máximo a las opciones que requieran un mobiliario de estas características. NEST ayuda que los ambientes sean más acogedores y es una alternativa original a las sillas comunes.

Italian design is a universal referral. NEST belongs to Contract range. The combination of different fabrics and a wide range of colors are available to reach the most demanding expectation of the customer. Create a cozy and friendly room with NEST chair.



FAUTEUIL
PIÈTEMENT
TRAÎNEAU

BUTACA CON
ESTRUCTURA
PATÍN

SLED FRAME
ARMCHAIR



| FAUTEUIL
| PLIABLE

| SILLÓN
| PLEGABLE

| FOLDING
| ARMCHAIR



Parfait pour être stocké sans perdre de place.
Ils sont équipés de deux roulettes et deux patins.
Perfecto para guardarlo sin ocupar espacio.
It can be stored in tiny corners.

NEST peut être tapissé en une ou deux teintes
différentes dans la même gamme de tissu.
Se puede tapizar con dos colores distintos
de tela.
Can be upholstered with two different colors
from the same fabric.

| FAUTEUIL FIXE

| SILLÓN FIJO

| FIXED ARMCHAIR





FAUTEUIL
GIRATOIRE





BUTACA
GIRATORIA

SWIVEL
ARMCHAIR



Bases pyramidales ou plates en aluminium poli. Fauteuil pivotant à 360° avec un système de retour automatique.
Base plana de aluminio pulido con rotación de 360°.
360° rotation polished aluminium swivel base.

MODÈLES | VARIANTES | VERSIONS

MODÈLE / VARIANTES / VERSIONS	RÉFÉRENCE / REFERENCIA / CODE				
 <p>Fauteuil fixe Sillón fijo Fixed chair</p>	162.060.108				
 <p>Fauteuil pliable Sillón plegable Folding chair</p>	162.061.108				
 <p>Fauteuil avec traîneau Butaca con patín Sled frame armchair</p>	162.062.104				
 <p>Fauteuil giratoire avec patins Butaca giratoria con conteras Swivel base armchair</p>	<table border="0"> <tr> <td>Pyramidale / Piramidal / Pyramidal</td> <td>Plate / Plana / Flat</td> </tr> <tr> <td>162.067.104</td> <td>162.068.104</td> </tr> </table>	Pyramidale / Piramidal / Pyramidal	Plate / Plana / Flat	162.067.104	162.068.104
Pyramidale / Piramidal / Pyramidal	Plate / Plana / Flat				
162.067.104	162.068.104				

FINITIONS | ACABADOS | FINISHES

TISSU AU CHOIX
TAPIZADO À ÉLEGIR
UPHOLSTERED



Cf. page 574
Ver pagina 574
See page 574

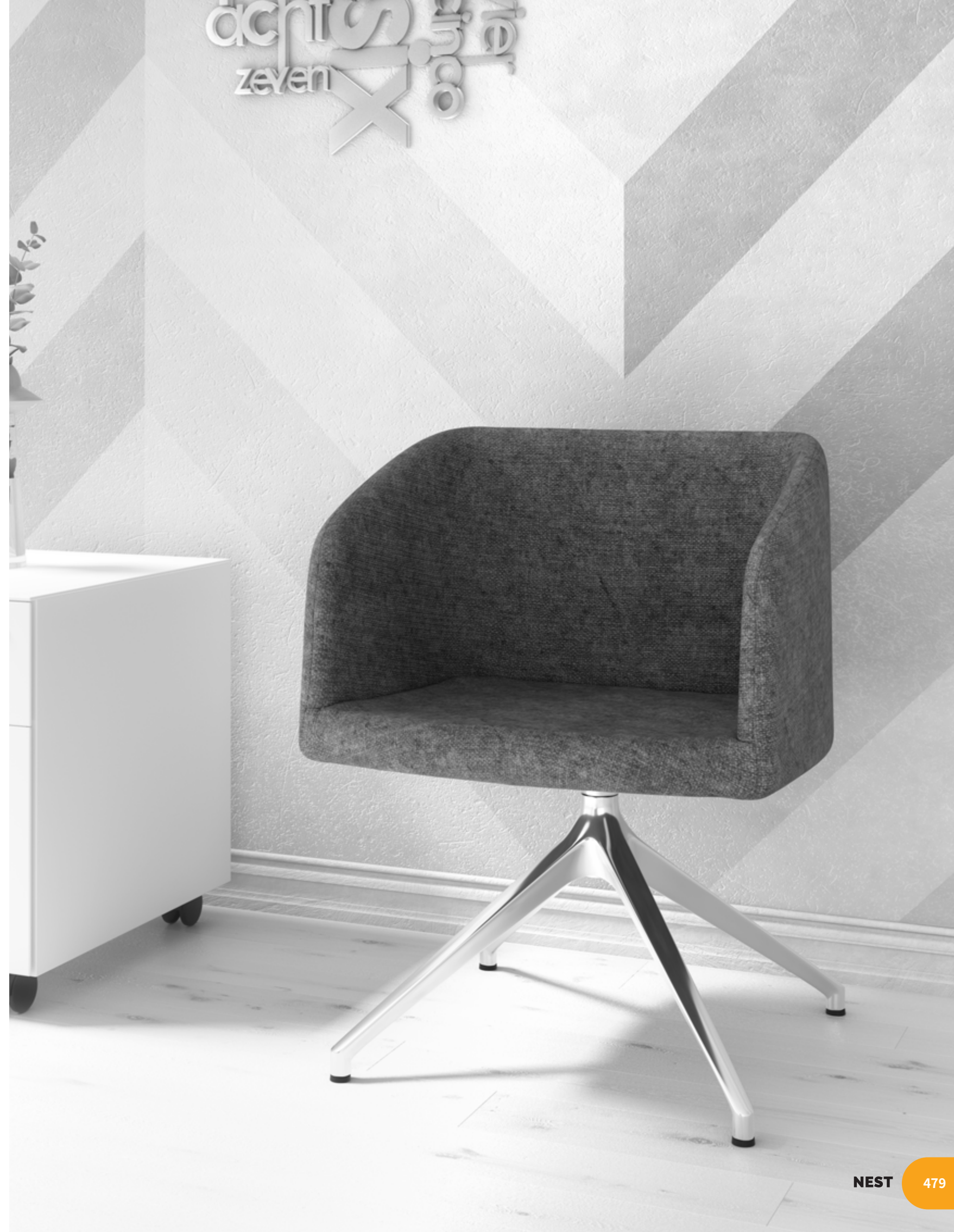

MR. JONES

Au design universel italien, les fauteuils et canapés MR.JONES appartiennent à la famille Contract. Les points forts de cette série sont une grande variété de couleurs et de structures qui permettent de répondre à vos besoins les plus exigeants. Les canapés et modules MR.JONES sont ambitieux et confortables.

El diseño italiano es un referente universal. Esta serie forma parte de la familia Contract. El punto fuerte de MR. JONES es la combinación de tapizados para adaptarse al máximo a las opciones que requieran un mobiliario de estas características. MR JONES es nuestro soft seating más atrevido. Su diseño y sistema de módulos no están reñidos con la comodidad.

Italian design is a universal referral. MR. JONES belongs to Contract range. The combination of different fabrics and a wide range of colors are available to reach the most demanding expectation of the customer. MR JONES soft seating is fresh, sassy and very comfortable.

CANAPÉS
MODULABLES

SOFÁ
MODULAR

MODULAR
SOFA



| CANAPÉ
| 1 PLACE

| SOFA
| 1 PLAZA

| 1 SEAT
| SOFA



| Conception innovante et fonctionnelle.
| Un diseño innovador maximizando el
| confort sin abandonar el buen gusto.
| Innovative design with comfort and
| great style.

| CANAPÉ 2 PLACES

| SOFA 2 PLAZAS

| 2 SEATER SOFA



| Gamme de canapés tapissables en une ou deux
| teintes différentes dans la même gamme de tissu.
| Se puede tapizar con dos colores distintos de tela.
| Can be upholstered with two different colors from
| the same fabric.



FAUTEUIL
GIRATOIRE

BUTACA
GIRATORIA







SWIVEL
ARMCHAIR





Base plate en aluminium poli. Fauteuil pivotant à 360° avec un système de retour automatique.

La base plana es de aluminio pulido con sistema autoretorno y rotación de 360°
Polished aluminium swivel base have 360° self-rotation system.

MODÈLES | VARIANTES | VERSIONS

MODÈLE / VARIANTES / VERSIONS	RÉFÉRENCE / REFERENCIA / CODE
 <p>Canapé 1 place Sofa 1 plaza Single seater sofa</p>	163.071.108
 <p>Canapé 2 places Sofa 2 plazas 2 seater sofa</p>	163.070.108
 <p>Fauteuil giratoire Butaca giratoria Swivel base armchair</p>	163.068.104
 <p>Modules 1 place Modulos 1 plaza Modular seat</p>	163.072.108
 <p>Modules 1 place Modulos 1 plaza Modular seat</p>	163.073.108
 <p>Modules angulaires 1 place Modulos angulares Modular angle seat</p>	163.074.108
 <p>Modules angulaires 1 place Modulos angulares Modular angle seat</p>	163.076.108

MODÈLE / VARIANTES / VERSIONS	RÉFÉRENCE / REFERENCIA / CODE
 <p>Module droit 1 place Modulo 1 plaza recto Modular seat (add-on)</p>	163.075.108
 <p>Pouf Pouf Pouf</p>	163.079.108

FINITIONS | ACABADOS | FINISHES

TISSU AU CHOIX
TAPIZADO A ELEGIR
UPHOLSTERED



Cf. page 574
Ver página 574
See page 574

Tom

Chaise aux lignes pures et minimalistes, la chaise TOM s'adapte à tous les espaces grâce à ces nombreuses versions.

Capaz de integrarse en cualquier espacio. La silla TOM se caracteriza por un estilo muy personal de líneas esbeltas y continuas, capaz de evolucionar en materiales, personalización y opciones.

Multipurpose chair with an elegant timeless style and shape.

EMPILABLE / APILABLE / STACKABLE





CHAISE
4 PIEDS

SILLA CON
4 PATAS

4 LEGS
CHAIR

CHAISE SANS
ACCOUDOIRS

SILLA 4 PATAS
SIN BRAZOS

4 LEGS CHAIR
WITHOUT ARMS

Coque en polypropylène disponible en
noir, blanc, bleu, rouge ou gris.
Carcasa de polipropileno disponible en
5 colores: negro, blanco, azul, rojo o gris.
Five shell colors available: black, white,
blue, red or grey.



CHAISE AVEC
ACCOUDOIRS

SILLA 4 PATAS
CON BRAZOS

4 LEGS CHAIR
WITH ARMS



CHAISE AVEC
TABLETTE ÉCRITOIRE

SILLA CON PALA
ESCRIBANÍA

CHAIR WITH
WRITING TABLET



Tablette écrite pour gauchers ou pour droitiers.
Escribanía para diestros o para zurdos.
Right or left hand writing tablet.

La structure peut être en noir, argent ou chromé.
La estructura puede ser acabada en: negro, plata o cromado.
Available frame finishes: black, silver or chrome.









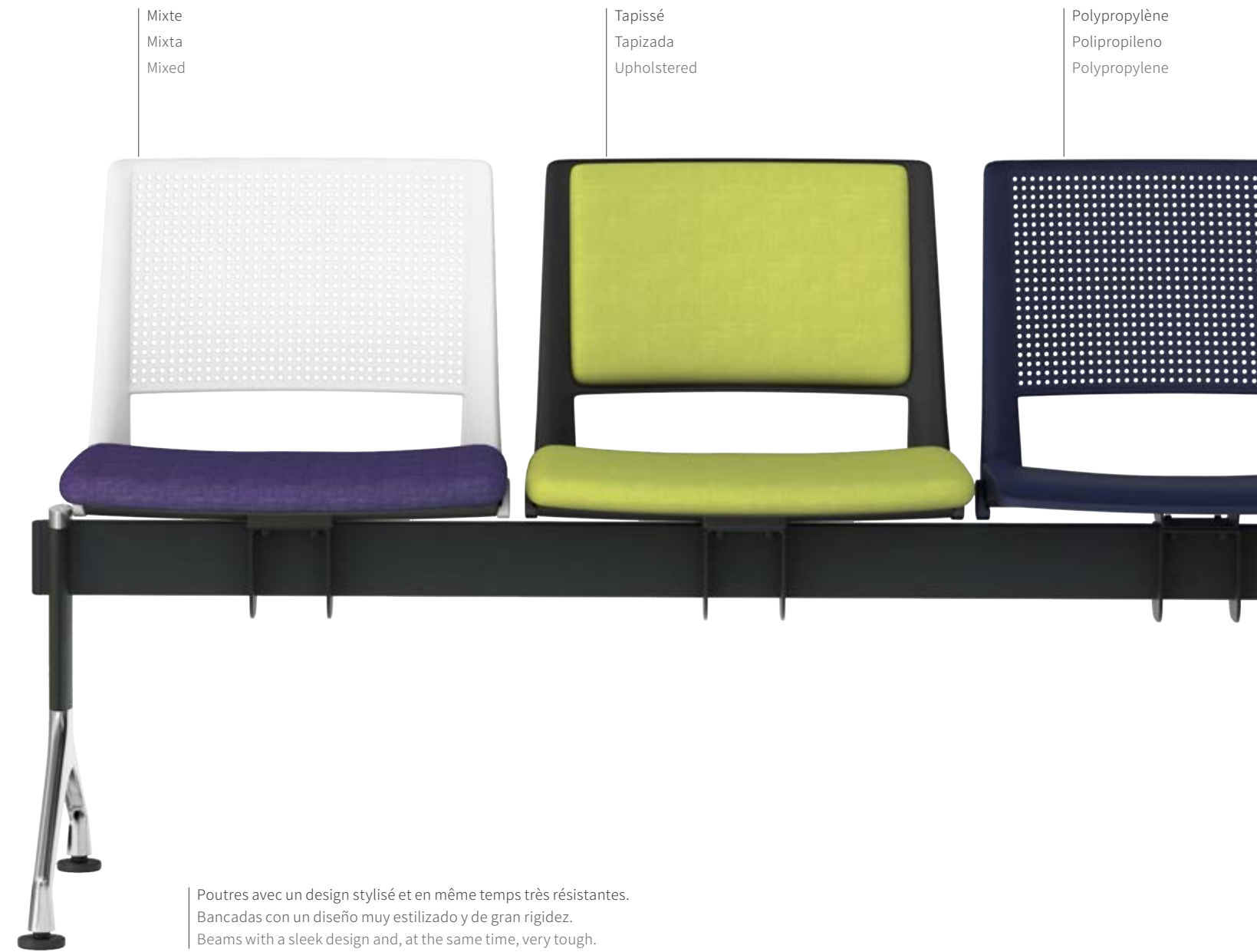





| POUTRE

| BANCADA

| BEAM FRAME



MODÈLES | VARIANTES | VERSIONS

MODÈLE / VARIANTES / VERSIONS	TYPE / TIPO / TYPE	RÉFÉRENCE / REFERENCIA / CODE										
 <p>B Assise et dossier: Tissu. Asiento y respaldo: Tapizado. Upholstered seat and backrest</p>	Sans accoudoirs / Sin brazos / Without arms	<table border="0"> <tr> <td></td> <td></td> <td></td> </tr> <tr> <td>142.071.101</td> <td>142.171.101</td> <td>142.471.101</td> </tr> <tr> <td>Avec accoudoirs / Con brazos / With arms</td> <td>142.072.101</td> <td>142.172.101</td> <td>142.472.101</td> </tr> </table>				142.071.101	142.171.101	142.471.101	Avec accoudoirs / Con brazos / With arms	142.072.101	142.172.101	142.472.101
												
142.071.101	142.171.101	142.471.101										
Avec accoudoirs / Con brazos / With arms	142.072.101	142.172.101	142.472.101									
 <p>C Assise et dossier: en polypropylène. Asiento y respaldo: en polipropileno. Polypropylene seat and backrest</p>	Sans accoudoirs / Sin brazos / Without arms	142.071.-.- 142.171.-.- 142.471.-.-										
	Avec accoudoirs / Con brazos / With arms	142.072.-.- 142.172.-.- 142.472.-.-										
 <p>E Assise: Tissu au choix. Dossier: en polypropylène. Asiento: Tapizado a elegir. Respaldo: en polipropileno. Upholstered seat. Polypropylene backrest</p>	Sans accoudoirs / Sin brazos / Without arms	142.071.-.- 142.171.-.- 142.471.-.-										
	Avec accoudoirs / Con brazos / With arms	142.072.-.- 142.172.-.- 142.472.-.-										













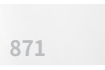

Structure Armazón Frame: Noire Negro Black (RAL 9005), Argentée Plata Silver (RAL 9006), Chromée Cromado Chrome

Chaise 4 pieds / Silla de 4 patas / 4 legs

 <p>B Assise et dossier: Tissu. Asiento y respaldo: Tapizado. Upholstered seat and backrest</p>	Tablette écriteiro à droite / Escribanía derecha / Writing tablet right	142.075.101 142.175.101 142.475.101
	Tablette écriteiro à gauche / Escribanía izquierda / Writing tablet left	142.076.101 142.176.101 142.476.101
 <p>C Assise et dossier: en polypropylène. Asiento y respaldo: en polipropileno. Polypropylene seat and backrest</p>	Tablette écriteiro à droite / Escribanía derecha / Writing tablet right	142.075.-.- 142.175.-.- 142.475.-.-
	Tablette écriteiro à gauche / Escribanía izquierda / Writing tablet left	142.076.-.- 142.176.-.- 142.476.-.-
 <p>E Assise: Tissu au choix. Dossier: en polypropylène. Asiento: Tapizado a elegir. Respaldo: en polipropileno. Upholstered seat. Polypropylene backrest</p>	Tablette écriteiro à droite / Escribanía derecha / Writing tablet right	142.075.-.- 142.175.-.- 142.475.-.-
	Tablette écriteiro à gauche / Escribanía izquierda / Writing tablet left	142.076.-.- 142.176.-.- 142.476.-.-

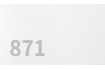
Visiteur 4 pieds, avec tablette écriteiro (noire) / Silla 4 patas con brazos y escribanía (negro) / 4 legs with writing tablet (black)













FINITIONS | ACABADOS | FINISHES

<p>B ASSISE ET DOSSIER: TISSU AU CHOIX. ASIENTO Y RESPALDO: TAPIZADO A ELEGIR. UPHOLSTERED SEAT AND BACKREST</p>  Cf. page 574 / Ver pagina 574 / See page 574	 211	Noir Negro Black	 271	Blanc Blanco White	 221	Bleu Azul Blue	 241	Rouge Rojo Red	 261	Gris Gris Grey
	<p>C POLYPROPYLÈNE POLIPROPILENO POLYPROPYLENE</p>	 811	Noir Negro Black	 871	Blanc Blanco White	 821	Bleu Azul Blue	 841	Rouge Rojo Red	 861
<p>E POLYPROPYLÈNE POLIPROPILENO POLYPROPYLENE</p>		 811	Noir Negro Black	 871	Blanc Blanco White	 821	Bleu Azul Blue	 841	Rouge Rojo Red	 861
	<p>ASSISE: TISSU AU CHOIX. ASIENTO: TAPIZADO A ELEGIR. UPHOLSTERED SEAT</p>  Cf. page 574 / Ver pagina 574 / See page 574									

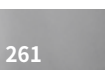
MODÈLES | VARIANTES | VERSIONS

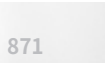
MODÈLE / VARIANTES / VERSIONS	TYPE / TIPO / TYPE	RÉFÉRENCE / REFERENCIA / CODE																			
 <p>Poutres Bancadas Beams</p>	Chaise / Sillas para bancadas / Beam chairs	142.061.-.-																			
	Structure / Estructura / Beam structure	<table border="0"> <tr> <td>Sans accoudoirs / Sin brazos / Without arms</td> <td>142.621.120</td> <td>Avec accoudoirs / Con brazos / With arms</td> <td>142.622.120</td> </tr> <tr> <td>2P. 102 x 48,2 X 43,6 cm</td> <td></td> <td>142.631.120</td> <td>142.632.120</td> </tr> <tr> <td>3P. 153 x 48,2 X 43,6 cm</td> <td></td> <td>142.641.120</td> <td>142.642.120</td> </tr> <tr> <td>4P. 204 x 48,2 X 43,6 cm</td> <td></td> <td>142.651.120</td> <td>142.652.120</td> </tr> <tr> <td>5P. 255 x 48,2 X 43,6 cm</td> <td></td> <td></td> <td></td> </tr> </table>	Sans accoudoirs / Sin brazos / Without arms	142.621.120	Avec accoudoirs / Con brazos / With arms	142.622.120	2P. 102 x 48,2 X 43,6 cm		142.631.120	142.632.120	3P. 153 x 48,2 X 43,6 cm		142.641.120	142.642.120	4P. 204 x 48,2 X 43,6 cm		142.651.120	142.652.120	5P. 255 x 48,2 X 43,6 cm		
Sans accoudoirs / Sin brazos / Without arms	142.621.120	Avec accoudoirs / Con brazos / With arms	142.622.120																		
2P. 102 x 48,2 X 43,6 cm		142.631.120	142.632.120																		
3P. 153 x 48,2 X 43,6 cm		142.641.120	142.642.120																		
4P. 204 x 48,2 X 43,6 cm		142.651.120	142.652.120																		
5P. 255 x 48,2 X 43,6 cm																					

FINITIONS | ACABADOS | FINISHES

<p>B ASSISE ET DOSSIER: TISSU AU CHOIX. ASIENTO Y RESPALDO: TAPIZADO A ELEGIR. UPHOLSTERED SEAT AND BACKREST</p>  Cf. page 574 / Ver pagina 574 / See page 574	 101									
	<p>C POLYPROPYLÈNE POLIPROPILENO POLYPROPYLENE</p>	 211	Noir Negro Black	 271	Blanc Blanco White	 221	Bleu Azul Blue	 241	Rouge Rojo Red	 261
<p>E POLYPROPYLÈNE POLIPROPILENO POLYPROPYLENE</p>		 811	Noir Negro Black	 871	Blanc Blanco White	 821	Bleu Azul Blue	 841	Rouge Rojo Red	 861
	<p>ASSISE: TISSU AU CHOIX. ASIENTO: TAPIZADO A ELEGIR. UPHOLSTERED SEAT</p>  Cf. page 574 / Ver pagina 574 / See page 574									

Marco

Dans son segment, ce modèle est le numéro un des ventes. Proposée dans de nombreuses versions, cette famille de chaises est complétée par de nombreuses options vous permettant ainsi d'adapter cette chaise à chaque utilisation.

En su segmento, es el número uno de ventas y es el modelo que más versiones ofrece. Además tiene una serie de complementos para optimizar el uso de las sillas.

MARCO chair is a best seller seating product and has largest versions available. A range of accessories can also be chosen to optimise every-day use of the chair.

EMPILABLE / APILABLE / STACKABLE



CHAISE AVEC
TABLETTE ÉCRITOIRE

SILLA CON PALA
ESCRIBANÍA

CHAIR WITH
WRITING TABLET



Tablette écrioire rabattable renforcée, à droite ou à gauche.
Escribanía derecha o izquierda y abatible.
Folding right or left hand writing tablet.



CHAISE VISITEUR 4
PIEDS POLYPROPYLENE

SILLA 4 PATAS
POLIPROPILENO

POLYPROPYLENE
4 LEGS

Chaises facilement empilables.
Se pueden apilar fácilmente.
Easily stackable.

CHAISE AVEC
ASSISE ET DOSSIER
EN BOIS

ASIENYO Y
RESPALDO EN
MADERA

WOOD SEAT
AND BACKREST

CHAISE VISITEUR
4 PIEDS TAPISSÉ

SILLA 4 PATAS
TAPIZADA

UPHOLSTERED
4 LEGS



Structure disponible en noir, argent ou graphite.
Estructura disponible en negro, plata o grafito.
Available frame finishes: black, silver or graphite.



Mixte: dossier perforé en polypropylène
noir et assise en tissu au choix.
Mixta: respaldo negro perforado
y asiento tapizado.
Mixed: black drilled backrest and
upholstered seat.

CHAISE VISITEUR
4 PIEDS MIXTE

SILLA CON
4 PATAS MIXTA

MIXED 4 LEGS
CHAIR

MODÈLES | VARIANTES | VERSIONS

MODÈLE / VARIANTES / VERSIONS	TYPE / TIPO / TYPE	RÉFÉRENCE / REFERENCIA / CODE
	Sans accoudoirs / Sin brazos / Without arms	87.711.-.-
	Avec accoudoirs / Con brazos / With arms	87.261.001
	Sans accoudoirs / Sin brazos / Without arms	87.711.-.-

Visiteur 4 pieds
Confi dente 4 patas
4 Legs

MODÈLE / VARIANTES / VERSIONS	TYPE / TIPO / TYPE	RÉFÉRENCE / REFERENCIA / CODE
	À droite / Derecha / Right hand	87.716.-.-

Visiteur 4 pieds avec tablette écriteoire (noire)
Confi dente 4 patas con escribania (negro)
4 legs chairs with writing tablet (black)

FINITIONS | ACABADOS | FINISHES

STRUCTURE ARMAZÓN FRAME

	Noire Negro Black	RAL 9005
	Argentée Plata Silver	RAL 9006
	Graphite Grafito Graphite	RAL 7022
	Chromée Cromado Chrome	

B ASSISE ET DOSSIER: TISSU AU CHOIX ASIENTO Y RESPALDO: TAPIZADO A ELEGIR UPHOLSTERED SEAT AND BACKREST

	101 Tissu Tela Fabric	Cf. page 574 Ver pagina 574 See page 574
	105 Tissu Tela Fabric	
	107 Tissu Tela Fabric	
	109 Tissu Tela Fabric	

C ASSISE ET DOSSIER EN POLYPROPYLENE ASIENTO Y RESPALDO EN POLIPROPILENO POLYPROPYLENE SEAT AND BACKREST

211	Noir Negro Black	221	Bleu Azul Blue	231	Vert Vedre Green	241	Rouge Rojo Red	251	Jaune Amarillo Yellow
215	Noir Negro Black	225	Bleu Azul Blue	235	Vert Vedre Green	245	Rouge Rojo Red	255	Jaune Amarillo Yellow
217	Noir Negro Black	227	Bleu Azul Blue	237	Vert Vedre Green	247	Rouge Rojo Red	257	Jaune Amarillo Yellow
219	Noir Negro Black	229	Bleu Azul Blue	239	Vert Vedre Green	249	Rouge Rojo Red	259	Jaune Amarillo Yellow

STRUCTURE ARMAZÓN FRAME

	Noire Negro Black	RAL 9005
	Argentée Plata Silver	RAL 9006
	Graphite Grafito Graphite	RAL 7022
	Chromée Cromado Chrome	

E ASSISE: TISSU AU CHOIX + DOSSIER EN POLYPROPYLENE ASIENTO: TAPIZADO A ELEGIR + RESPALDO POLIPROPILENO UPHOLSTERED SEAT + POLYPROPYLENE BACKREST

	301 Tissu Tela Fabric	Cf. page 574 Ver pagina 574 See page 574
	305 Tissu Tela Fabric	
	307 Tissu Tela Fabric	
	309 Tissu Tela Fabric	

I ASSISE ET DOSSIER CONTRE-PLAQUÉ ASIENTO Y RESPALDO: MADERA LAMINADA WOOD SEAT AND BACKREST

411	Hêtre Naturel Haya natural Natural beech	421	Poirier Peral Pear	431	Vert Vedre Green	441	Bleu Azul Blue
415	Hêtre Naturel Haya natural Natural beech	425	Poirier Peral Pear	435	Vert Vedre Green	445	Bleu Azul Blue
417	Hêtre Naturel Haya natural Natural beech	427	Poirier Peral Pear	437	Vert Vedre Green	447	Bleu Azul Blue
419	Hêtre Naturel Haya natural Natural beech	429	Poirier Peral Pear	439	Vert Vedre Green	449	Bleu Azul Blue

MODÈLES | VARIANTES | VERSIONS

MODÈLE / VARIANTES / VERSIONS	TYPE / TIPO / TYPE	RÉFÉRENCE / REFERENCIA / CODE
	À droite / Derecha / Right hand	87.712.-.-
	À gauche / Izquierda / Left hand	87.713.-.-

Visiteur 4 pieds avec tablette écriteoire
Confi dente 4 patas con escribania
4 legs with writing tablet (black)





FINITIONS | ACABADOS | FINISHES

STRUCTURE ARMAZÓN FRAME

	Noire Negro Black	RAL 9005
	Argentée Plata Silver	RAL 9006
	Graphite Grafito Graphite	RAL 7022

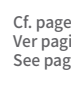
Écritoire Escribania Writing tablet

B ASSISE ET DOSSIER: TISSU AU CHOIX ASIENTO Y RESPALDO: TAPIZADO A ELEGIR UPHOLSTERED SEAT AND BACKREST

	101 Tissu Tela Fabric	Cf. page 574 Ver pagina 574 See page 574
	102 Tissu Tela Fabric	
	105 Tissu Tela Fabric	
	106 Tissu Tela Fabric	
	107 Tissu Tela Fabric	
	108 Tissu Tela Fabric	

C ASSISE ET DOSSIER EN POLYPROPYLENE ASIENTO Y RESPALDO EN POLIPROPILENO POLYPROPYLENE SEAT AND BACKREST

211	Noir Negro Black	221	Bleu Azul Blue	231	Vert Vedre Green	241	Rouge Rojo Red	251	Jaune Amarillo Yellow
212	Noir Negro Black	222	Bleu Azul Blue	232	Vert Vedre Green	242	Rouge Rojo Red	252	Jaune Amarillo Yellow
215	Noir Negro Black	225	Bleu Azul Blue	235	Vert Vedre Green	245	Rouge Rojo Red	255	Jaune Amarillo Yellow
216	Noir Negro Black	226	Bleu Azul Blue	236	Vert Vedre Green	246	Rouge Rojo Red	256	Jaune Amarillo Yellow
217	Noir Negro Black	227	Bleu Azul Blue	237	Vert Vedre Green	247	Rouge Rojo Red	257	Jaune Amarillo Yellow
218	Noir Negro Black	228	Bleu Azul Blue	238	Vert Vedre Green	248	Rouge Rojo Red	258	Jaune Amarillo Yellow

STRUCTURE ARMAZÓN FRAME

	Noire Negro Black	RAL 9005
	Argentée Plata Silver	RAL 9006
	Graphite Grafito Graphite	RAL 7022

Écritoire Escribania Writing tablet

E ASSISE: TISSU AU CHOIX + DOSSIER EN POLYPROPYLENE ASIENTO: TAPIZADO A ELEGIR + RESPALDO POLIPROPILENO UPHOLSTERED SEAT + POLYPROPYLENE BACKREST

	301 Tissu Tela Fabric	Cf. page 574 Ver pagina 574 See page 574
	302 Tissu Tela Fabric	
	305 Tissu Tela Fabric	
	306 Tissu Tela Fabric	
	307 Tissu Tela Fabric	
	308 Tissu Tela Fabric	

I ASSISE ET DOSSIER CONTRE-PLAQUÉ ASIENTO Y RESPALDO: MADERA LAMINADA WOOD SEAT AND BACKREST

411	Hêtre Naturel Haya natural Natural beech	421	Poirier Peral Pear	431	Vert Vedre Green	441	Bleu Azul Blue
412	Hêtre Naturel Haya natural Natural beech	422	Poirier Peral Pear	432	Vert Vedre Green	442	Bleu Azul Blue
415	Hêtre Naturel Haya natural Natural beech	425	Poirier Peral Pear	435	Vert Vedre Green	445	Bleu Azul Blue
416	Hêtre Naturel Haya natural Natural beech	426	Poirier Peral Pear	436	Vert Vedre Green	446	Bleu Azul Blue
417	Hêtre Naturel Haya natural Natural beech	427	Poirier Peral Pear	437	Vert Vedre Green	447	Bleu Azul Blue
418	Hêtre Naturel Haya natural Natural beech	428	Poirier Peral Pear	438	Vert Vedre Green	448	Bleu Azul Blue

MODÈLES | VARIANTES | VERSIONS

MODÈLE / VARIANTES / VERSIONS	TYPE / TIPO / TYPE	RÉFÉRENCE / REFERENCIA / CODE
	Sans accoudoirs / Sin brazos / Without arms	87.111.001
	Avec accoudoirs / Con brazos / With arms	87.211.001

Chaise giratoire
Sillas giratoria
Swivel chairs

Cf. page 574
Ver pagina 574
See page 574

Replay

Simplicité et design. La chaise REPLAY est très polyvalente et s'adapte à tout type d'ambiance.

La silla REPLAY sigue una estética atemporal indiferente a estilos y a tendencias.

Replay chair has a timeless style and matches with any trend.

EMPILABLE / APILABLE / STACKABLE



CHAISE 4 PIEDS
AVEC SYSTÈME
D'UNION

SILLA CON 4 PATAS
CON GANCHO DE
UNIÓN

4 LEGS CHAIR
WITH LINKING
BRACKET

Possibilité d'avoir un système d'union pour unir les chaises entre elles.

Con herraje de unión opcional para unir las sillas entre sí.

With joining fitting to join chairs in a row.

CHAISE
4 PIEDS AVEC
ACCOUDOIRS

SILLA CON
4 PATAS Y
BRAZOS

4 LEGS CHAIR
WITH ARMS

Disponible avec ou sans accoudoirs.
Disponible con o sin brazos.
Frame available with or without arms.



Coque en polypropylène avec le dossier micro perforé disponible en noir, blanc, bleu, rouge ou gris.
Carcasa plástica con el respaldo perforado en distintos colores: negro, blanco, azul, rojo o gris.
Plastic drilled backrest in different finishes: black, white, blue, red or grey.

CHAISE
4 PIEDS

SILLA CON
4 PATAS





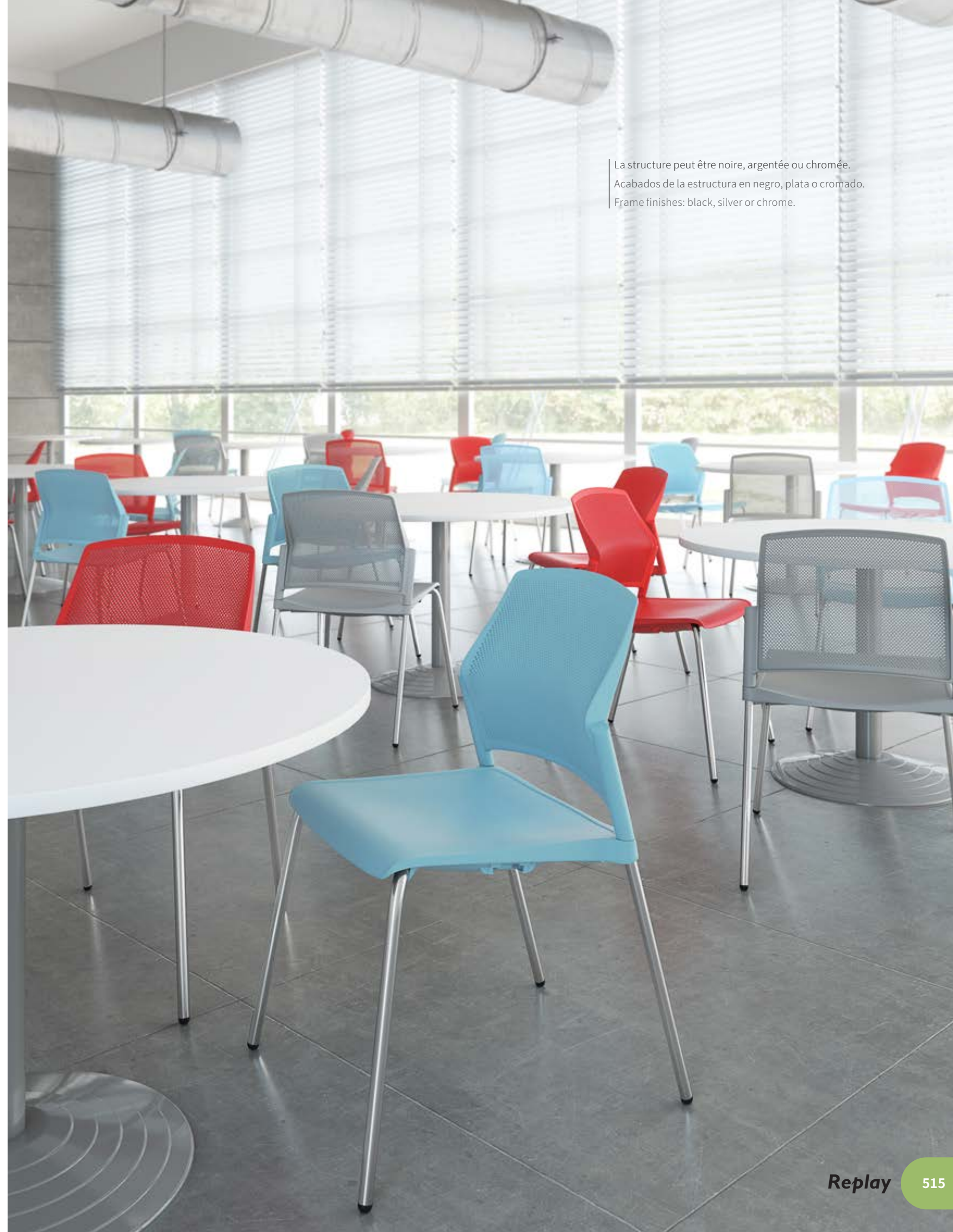





4 LEGS
CHAIR

La structure peut être noire, argentée ou chromée.
Acabados de la estructura en negro, plata o cromado.
Frame finishes: black, silver or chrome.













MODÈLES | VARIANTES | VERSIONS

Structure Armazón Frame	 Noire Negro Black RAL 9005	 Argentée Plata Silver RAL 9006	 Chromée Cromado Chrome
-------------------------------	--	---	--

MODÈLE / VARIANTES / VERSIONS	TYPE / TIPO / TYPE	RÉFÉRENCE / REFERENCIA / CODE									
	Assise et dossier: en polypropylène Asiento y respaldo: en polipropileno Polypropylene seat and backrest	<table> <tr> <td></td> <td></td> <td></td> </tr> <tr> <td>Sans accoudoirs / Sin brazos / Without arms 143.071.-.-</td> <td>143.171.-.-</td> <td>143.471.-.-</td> </tr> <tr> <td>Avec accoudoirs / Con brazos / With arms 143.072.-.-</td> <td>143.172.-.-</td> <td>143.472.-.-</td> </tr> </table>				Sans accoudoirs / Sin brazos / Without arms 143.071.-.-	143.171.-.-	143.471.-.-	Avec accoudoirs / Con brazos / With arms 143.072.-.-	143.172.-.-	143.472.-.-
											
Sans accoudoirs / Sin brazos / Without arms 143.071.-.-	143.171.-.-	143.471.-.-									
Avec accoudoirs / Con brazos / With arms 143.072.-.-	143.172.-.-	143.472.-.-									

Chaise 4 pieds
Silla de 4 patas
4 legs

	Assise et dossier: en polypropylène Asiento y respaldo: en polipropileno Polypropylene seat and backrest	<table> <tr> <td></td> <td></td> <td></td> </tr> <tr> <td>Sans accoudoirs / Sin brazos / Without arms 143.079.-.-</td> <td>143.179.-.-</td> <td>143.479.-.-</td> </tr> <tr> <td>Avec accoudoirs / Con brazos / With arms 143.074.-.-</td> <td>143.174.-.-</td> <td>143.474.-.-</td> </tr> </table>				Sans accoudoirs / Sin brazos / Without arms 143.079.-.-	143.179.-.-	143.479.-.-	Avec accoudoirs / Con brazos / With arms 143.074.-.-	143.174.-.-	143.474.-.-
											
Sans accoudoirs / Sin brazos / Without arms 143.079.-.-	143.179.-.-	143.479.-.-									
Avec accoudoirs / Con brazos / With arms 143.074.-.-	143.174.-.-	143.474.-.-									

Chaise 4 pieds, avec système d'union
Silla de 4 patas, con sistema de unión entre sillas
4 legs with linking bracket

FINITIONS | ACABADOS | FINISHES

POLYPROPYLÈNE / POLIPROPILENO / POLYPROPYLENE

 211 Noir Negro Black	 271 Blanc Blanco White	 221 Bleu Azul Blue	 241 Rouge Rojo Red	 261 Gris Gris Grey
---	---	---	---	---



Ondara

Ce siège vous offre, à un prix très compétitif, un piètement chromé et une large gamme de finitions pour la coque.

Esta silla ofrece una estructura cromada y cinco colores de acabado de carcasa a un precio inmejorable.

ONDARA has a really competitive price and a wide range of finishes for the shell and frame.

EMPILABLE / APILABLE / STACKABLE



CHAISE 4
PIEDS

SILLA CON 4
PATAS

4 LEGS
CHAIR



CHAISE
AVEC TABLETTE
ÉCRITOIRE

SILLA CON PALA
ESCRIBANÍA

CHAIR WITH
WRITING TABLET



Tablette écrite uniquement à droite optionelle.
Escribanía opcional en el brazo derecho.
Optional right hand writing tablet.

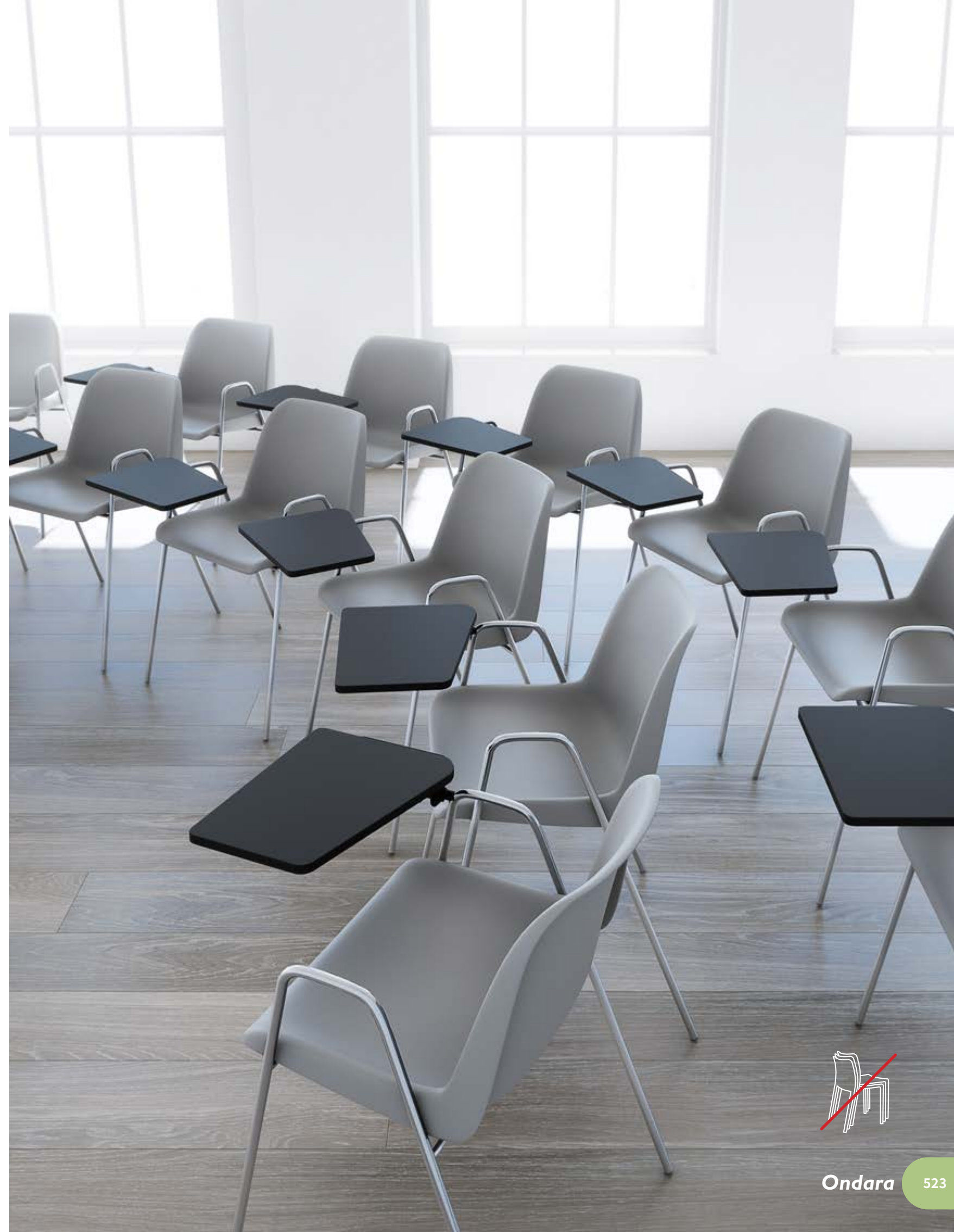

CHAISE 4 PIEDS
AVEC SYSTÈME
D'UNION

SILLA CON 4 PATAS
CON GANCHO DE
UNIÓN

4 LEGS CHAIR
WITH LINKING
BRACKET

CHAISE AVEC
ACCOUDOIRS

SILLA CON 4
PATAS Y BRAZOS

4 LEGS CHAIR
WITH ARMS



Structure avec ou sans accoudoirs.
Estructura con o sin brazos.
Frame with or without fixed arms.



Coque en polypropylène disponible en gris, noir, bleu ou rouge.
Diferentes acabados para la monocarcasa: gris, negra, azul o rojo.
Shell finishes: grey, black, blue or red.

MODÈLES | VARIANTES | VERSIONS

Structure
Armazón
Frame

Chromée
Cromado
Chrome

MODÈLE / VARIANTES / VERSIONS	TYPE / TIPO / TYPE	RÉFÉRENCE / REFERENCIA / CODE
	Sans accoudoirs / Sin brazos / Without arms	64.711.---
	Sans accoudoirs avec système d'union Sin brazos con gancho unión Without arms with linking bracket	64.714.---
	Avec accoudoirs / Con brazos / With arms	64.712.---
	Avec accoudoirs / Con brazos / With arms	64.716.---

Chaise 4 pieds
Silla de 4 patas
4 legs

Visiteur 4 pieds, avec tablette écrite
Silla 4 patas con brazos y escribanía
4 legs with writing tablet (black)

FINITIONS | ACABADOS | FINISHES

POLYPROPYLÈNE / POLIPROPILENO / POLYPROPYLENE

269	Gris Gris Grey	279	Beige Beige Beige	219	Noir Negro Black	229	Bleu Azul Blue	249	Rouge Rojo Red
-----	----------------------	-----	-------------------------	-----	------------------------	-----	----------------------	-----	----------------------



Viena

Chaises à quatre pieds avec roulettes et assise relevable, idéales pour les tables NET.
Les chaises VIENA sont parfaites pour les salles polyvalentes.

Silla con 4 patas y ruedas complementaria a la serie de mesas NET ideales para equipar salas con diferentes usos o distribuciones muy cambiantes.

Four legs chair with wheels that matches with NET desk range. These chairs are perfect for multipurpose rooms.



Assise rabattable
Asiento abatible
Foldable seat



Dossier réglable
Inclinación respaldo
Backrest adjustment



CHAISE VISITEUR
4 PIEDS SUR
ROULETTES

SILLA CON 4
PATAS Y CON
RUEDAS

4 LEGS
CHAIR WITH
CASTORS

Chaise confortable, légère et très fonctionnelle.
Una silla ligera, funcional y cómoda.
This chair is comfortable, light and very functional.

| CHAISE VISITEUR
| LUGE

| SILLA BALANCÍN

| CANTILEVER CHAIR



| Structure argentée, dossier en résille
noire et assise en tissu noir.
Respaldo en rejilla negra, balancín
acabado plata y asiento con tela
transpirable negra.
Black mesh backrest, black breathable
seat fabric and silver frame.



MODÈLES | VARIANTES | VERSIONS

MODÈLE / VARIANTES / VERSIONS	TYPE / TIPO / TYPE	RÉFÉRENCE / REFERENCIA / CODE	
	Avec accoudoirs fixes / Con brazos fijos / With fixed arms	1 U. / 1 U. / 1 chairs	4 U. / 4 U. / 4 chairs
Visiteur 4 pieds avec roulettes 4 patas con ruedas 4 legs with casters		126.102.321	126.102.325
	Avec accoudoirs fixes / Con brazos fijos / With fixed arms	1 U. / 1 U. / 1 chairs	3 U. / 3 U. / 3 chairs
Luge Balancín Cantilever		126.802.321	126.802.323



Ródano

Reconnue par le marché, la chaise RODANO vous offre un grand nombre de finitions de structure avec accoudoirs intégrés. Il vous suffira de choisir le coloris de tissu adapté à l'environnement que vous souhaitez créer.

Esta silla tiene una trayectoria muy consolidada en el mercado y una amplia gama de acabados para la estructura. Se puede escoger cualquier tela o piel del catálogo de tapizados.

This chair has a very consolidate background in the furniture market and a wide range of finishes for its structure. Any finish of the fabric and leather folder is suitable.

EMPILABLE / APILABLE / STACKABLE



CHAISE VISITEUR
4 PIEDS

SILLA CON 4
PATAS

4 LEGS
CHAIR

Structure avec accoudoirs intégrés disponible
en coloris noir, argent, graphite ou chromé.
Estructura disponible en negro, plata, grafito
o cromada.
Frame available finishes: black, silver, graphite
or chrome.



CHAISE VISITEUR
4 PIEDS

SILLA 4 PATAS

4 LEGS CHAIR



Assise et dossier en tissu.
Asiento y respaldillo tapizados.
Upholstered back and seat.

Tablette écrioire à droite en option.
Con escribanía a la derecha opcional.
Optional right writing tablet.





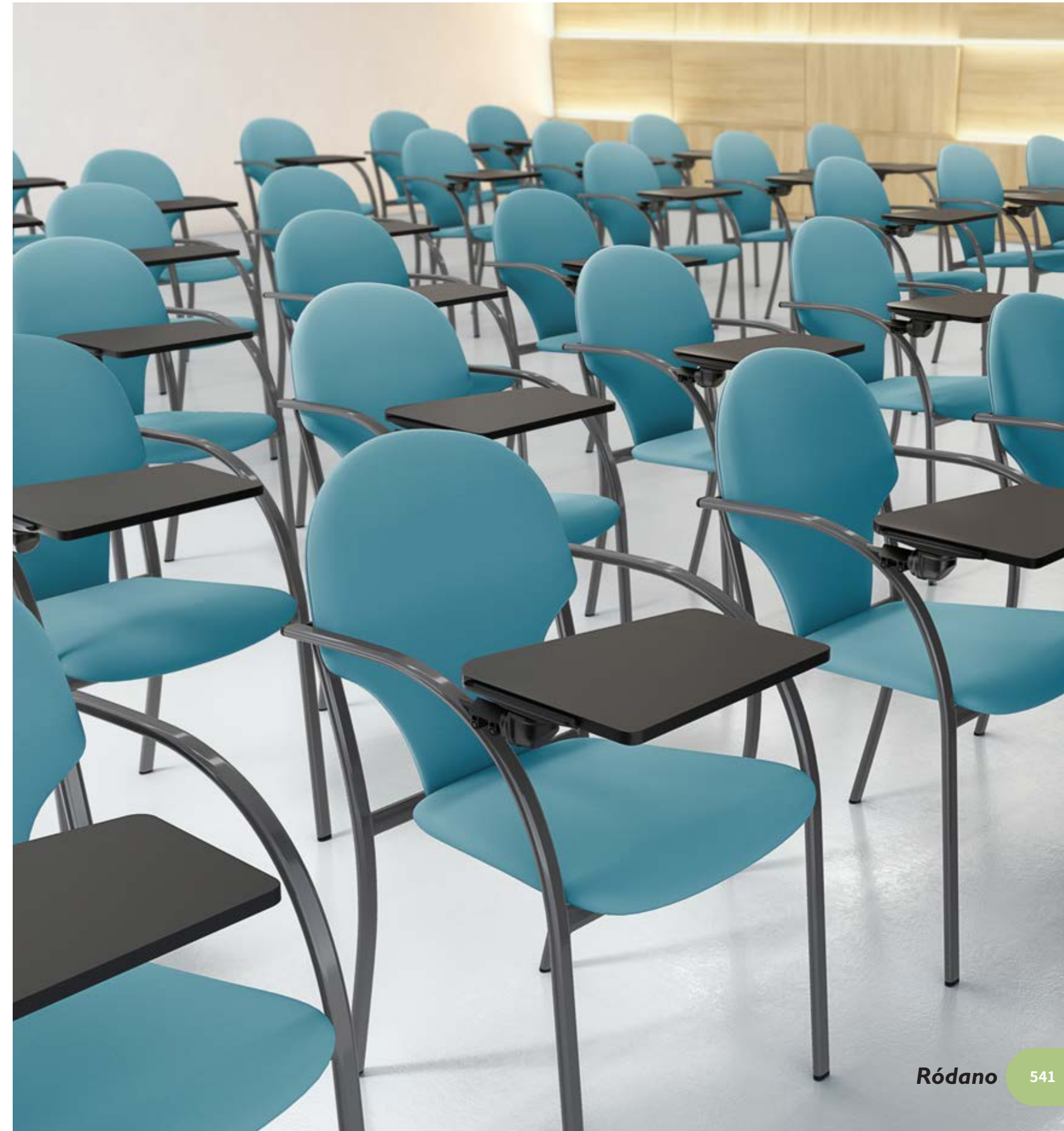

CHAISE AVEC
TABLETTE
ÉCRITOIRE

SILLA
CON PALA
ESCRIBANÍA

CHAIR WITH
WRITING TABLET



MODÈLES | VARIANTES | VERSIONS

MODÈLE / VARIANTES / VERSIONS	RÉFÉRENCE / REFERENCIA / CODE			
	 89.261.001	 89.265.001	 89.267.001	 89.269.001

Visiteur 4 pieds
Confidente 4 patas
4 Legs

	89.251.001	89.255.001	89.257.001	89.259.001
---	------------	------------	------------	------------

Visiteur 4 pieds avec tablette écrite
Confidente 4 patas con escribanía
4 legs with writing tablet (black)

FINITIONS | ACABADOS | FINISHES

STRUCTURE
ARMAZÓN
FRAME

 Noire
Negro
Black
RAL 9005

 Argentée
Plata
Silver
RAL 9006

 Graphite
Grafito
Graphite
RAL 7022

 Chromée
Cromado
Chrome

ASSISE ET DOSSIER: TISSU AU CHOIX
ASIENTO Y RESPALDO: TAPIZADO A ELEGIR
UPHOLSTERED SEAT AND BACKREST



Cf. page 574
Ver pagina 574
See page 574



Split

L'élégance de son design et le détail de ses finitions constituent une gamme de sièges qui vous donnera pleine satisfaction pendant de nombreuses années.

La elegancia de sus líneas y el detalle de los acabados constituyen un modelo que dará plena satisfacción durante muchos años.

Chair with an elegant design and high-quality finishes that guarantees user comfort for a long period of time.

EMPILABLE / APILABLE / STACKABLE



CHAISE VISITEUR
4 PIEDS

SILLA CON 4
PATAS

4 LEGS
CHAIR



CHAISE VISITEUR
AVEC ACCOUDOIRS

SILLA CON
BRAZOS





CHAIR WITH
ARMS



La structure peut être en noir, argent, graphite ou chromé.
La estructura puede ser en acabado negro, plata, grafito o cromado.
Available finishes for the frame are: black, silver, graphite or chrome.



MODÈLES | VARIANTES | VERSIONS

MODÈLE / VARIANTES / VERSIONS	RÉFÉRENCE / REFERENCIA / CODE			
	 98.712.101	 98.712.105	 98.712.107	 98.712.109

Visiteur 4 pieds
Confidente 4 patas
4 Legs

FINITIONS | ACABADOS | FINISHES

STRUCTURE
ARMAZÓN
FRAME



Noire
Negro
Black
RAL 9005

Argentée
Plata
Silver
RAL 9006

Graphite
Grafito
Graphite
RAL 7022

Chromée
Cromado
Chrome

ASSISE ET DOSSIER: TISSU AU CHOIX
ASIENTO Y RESPALDO: TAPIZADO A ELEGIR
UPHOLSTERED SEAT AND BACKREST

 Cf. page 574
Ver pagina 574
See page 574



Navia

NAVIA est une série de chaises polyvalentes, fabriquée en bois, au design moderne disponible en deux versions. Cette chaise est déclinée soit avec une structure à quatre pieds, soit avec une structure prévue pour un appui sur table, en acier ou en aluminium, recommandée pour les locaux qui ont besoin d'un nettoyage quotidien.

El encanto de la madera presentada en colores contribuye a la gran versatilidad de esta silla. Este modelo está en versión cuatro patas o balancín inverso. En los locales que requieren una manipulación diaria, por motivos de limpieza, se aconseja que se elija el modelo con armazón de aluminio.

NAVIA is a versatile product range with charming wood finishes. The product is available in two versions: Four legs frame or inverted cantilever frame. Aluminium frame version is highly recommended in case is used in rooms where is done daily maintenance or cleaning.

EMPILABLE / APILABLE / STACKABLE



CHAISE VISITEUR
4 PIEDS

SILLA CON 4
PATAS

4 LEGS
CHAIR



Finitions disponibles de la coque en bois:
hêtre naturel, poirier, vert ou bleu.
Los acabados de madera son: haya
natural, peral, verde o azul.
Wood finishes are: natural beech, pear,
green or blue.

CHAISE VISITEUR
4 PIEDS

La structure peut être noire, argentée, graphite ou chromée.
Estructura disponible en negro, plata, grafito o cromado.
Available frame finishes: black, silver, graphite or chrome.

SILLA CON 4
PATAS



4 LEGS
CHAIR



Dossier avec un design exclusif.
Respaldo con un diseño exclusivo.
Exclusive backrest design.

La structure du luge inversée peut être en acier ou en aluminium.
La estructura de balancín inverso está disponible en acero o en aluminio.
Inverse cantilever frame is available in steel or aluminium finish.





CHAISE APPUI
SUR TABLE

SILLA CON
BALANCÍN
INVERSO

INVERSE
CANTILEVER CHAIR





















MODÈLES | VARIANTES | VERSIONS

MODÈLE / VARIANTES / VERSIONS	RÉFÉRENCE / REFERENCIA / CODE
 <p>Visiteur 4 pieds Confidente 4 patas 4 Legs</p>	88.711.---

	88.811.---
 <p>Chaise appui sur table Balancín inverso Inverted cantilever</p>	88.911.---

FINITIONS | ACABADOS | FINISHES

STRUCTURE ARMAZÓN FRAME

 Noire Negro Black RAL 9005	 411 Hêtre Naturel Haya natural Natural beech	 421 Poirier Peral Pear	 431 Vert Verde Green	 441 Bleu Azul Blue
 Argentée Plata Silver RAL 9006	 415 Hêtre Naturel Haya natural Natural beech	 425 Poirier Peral Pear	 435 Vert Verde Green	 445 Bleu Azul Blue
 Graphite Grafito Graphite RAL 7022	 417 Hêtre Naturel Haya natural Natural beech	 427 Poirier Peral Pear	 437 Vert Verde Green	 447 Bleu Azul Blue
 Chromée Cromado Chrome	 419 Hêtre Naturel Haya natural Natural beech	 429 Poirier Peral Pear	 439 Vert Verde Green	 449 Bleu Azul Blue



sf

Canapé au design sobre et luxueux aux dimensions généreuses.

Líneas de sofás que abarcan un amplio abanico de posibilidades, en función de su volumen, diseño y calidad.

Sofa to fulfill a wide range of possibilities, given the size, design and quality options.

| CANAPÉS SF1

| SOFÁS SF1

| SF1 SOFAS



| CANAPÉS SF1

| SOFÁS SF1

| SF1 SOFAS



Canapé de dimensions généreuses disponible en fauteuil et canapé deux ou trois places. Il est conçu pour apporter un grand confort aux espaces de travail et de détente.
Sofá de medidas generosas que cuenta con un asiento amplio de una, dos y tres plazas. Diseñados para la comodidad y adaptación en espacios de trabajo.
Executive sofa with wide dimensions of one, two and three seaters. Designed to make more comfortable office workplaces.



| CANAPÉS SF2

| SOFÁS SF2

| SF2 SOFAS

Canapé aux lignes élégantes et fluides, disponible en fauteuil et canapé deux ou trois places.
Sofás con formas elegantes y rectas de una, dos y tres plazas.
One, two and three seater sofas with straight and elegant shapes.

| CANAPÉS SF2

| SOFÁS SF2

| SF2 SOFAS

Pieds chromés aux formes modernes.
Las patas tienen forma triangular y cromadas.
Triangular chrome legs.



| CANAPÉS SF3

| SOFÁS SF3

| SF3 SOFAS





| CANAPÉS SF3

| SOFÁS SF3



| SF3 SOFAS





Canapé avec un design austère, pratique et de lignes carrées, disponible en une ou deux places.
Sofá de una y dos plazas con un diseño austero y práctico. De forma moderna y sencilla que se adapta a cualquier ambiente.
One and two seater sofas with a stark and useful design.

MODÈLES | VARIANTES | VERSIONS

SF1

MODÈLE / VARIANTES / VERSIONS	DIMENSIONS / MEDIDAS / MEASUREMENTS	RÉFÉRENCE / REFERENCIA / CODE
	Prof./ Depth. 96 cm L.120 H.85 cm	110.612.000
1 place 1 plaza 1 seat		
	Prof./ Depth. 96 cm L.171 H.85 cm	110.632.000
2 places 2 plazas 2 seater		
	Prof./ Depth. 96 cm L.228 H.85 cm	110.642.000
3 places 3 plazas 3 seater		

SF2

MODÈLE / VARIANTES / VERSIONS	DIMENSIONS / MEDIDAS / MEASUREMENTS	RÉFÉRENCE / REFERENCIA / CODE
	Prof./ Depth. 87 cm L.106 H.73 cm	111.612.000
1 place 1 plaza 1 seat		
	Prof./ Depth. 88 cm L.157 H.73 cm	111.632.000
2 places 2 plazas 2 seater		
	Prof./ Depth. 88 cm L.210 H.73 cm	111.642.000
3 places 3 plazas 3 seater		

SF3

MODÈLE / VARIANTES / VERSIONS	DIMENSIONS / MEDIDAS / MEASUREMENTS	RÉFÉRENCE / REFERENCIA / CODE
	Prof./ Depth. 68,5 cm L.78 H.79 cm	112.612.000
1 place 1 plaza 1 seat		
	Prof./ Depth. 68,5 cm L.134 H.79 cm	112.632.000
2 places 2 plazas 2 seater		
	65 x 65 cm 122 x 65 cm	112.690.000 112.680.000
Tables basses Mesas de centro Coffee tables		

FINITIONS | ACABADOS | FINISHES

TISSU AU CHOIX
TAPIZADO A ELEGIR
UPHOLSTERED



Cf. page 574
Ver pagina 574
See page 574

MODÈLES | VARIANTES | VERSIONS

TAK

MODÈLE / VARIANTES / VERSIONS	DIMENSIONS / MEDIDAS / MEASUREMENTS	RÉFÉRENCE / REFERENCIA / CODE
	120 x 60 cm 95 x 95 cm 60 x 60 cm	Mélamine / Melamina / Melamine Bois / Madera / Wood
		561.115.-.- 561.117.-.- 561.116.-.-
		561.415.-.- 561.417.-.- 561.416.-.-
FINITIONS ACABADOS FINISHES		
Mélamine Melamina Melamine	053 Blanc Blanco White 104 Acacia Foncé Acacia Oscura Dark Acacia	103 Acacia Clair Acacia Clara Light Acacia 105 Zebano Zebano Zebano
Bois Madera Wood	365 Noyer Américain Nogal Americano American Walnut	

Tables basses
Mesas de centro
Coffee tables

ROCK 3

MODÈLE / VARIANTES / VERSIONS	DIMENSIONS / MEDIDAS / MEASUREMENTS	RÉFÉRENCE / REFERENCIA / CODE
	120 x 60 cm 95 x 95 cm 60 x 60 cm	431.315.-.- 431.316.-.- 431.317.-.-
FINITIONS ACABADOS FINISHES		
	053 Blanc Blanco White 062 Poirier Peral Pear 104 Acacia Foncé Acacia Oscura Dark Acacia	054 Gris Gris Grey 116 Wengué Wengué Wengué 105 Zebano Zebano Zebano
		055 Hêtre Haya Beech 007 Graphite Grafito Graphite 103 Acacia Clair Acacia Clara Light Acacia
		061 Chêne Moyen Roble Maple

Tables basses
Mesas de centro
Coffee tables

BROS

MODÈLE / VARIANTES / VERSIONS	DIMENSIONS / MEDIDAS / MEASUREMENTS	RÉFÉRENCE / REFERENCIA / CODE
	120 x 60 cm 95 x 95 cm 66 x 66 cm	57.040.-.- 57.042.-.- 57.041.-.-
FINITIONS ACABADOS FINISHES		
	053 Blanc Blanco White 062 Poirier Peral Pear 104 Acacia Foncé Acacia Oscura Dark Acacia	054 Gris Gris Grey 116 Wengué Wengué Wengué 105 Zebano Zebano Zebano
		055 Hêtre Haya Beech 007 Graphite Grafito Graphite 103 Acacia Clair Acacia Clara Light Acacia
		061 Chêne Moyen Roble Maple
Structure Armazón Frame	Noire Negro Black Argentée Plata Silver Blanche Blanco White Graphite Grafito Graphite Chromée Cromado Chrome	
	RAL 9005 RAL 9006 RAL 9016 RAL 7022	

Tables basses
Mesas de centro
Coffee tables

SERIE 82

MODÈLE / VARIANTES / VERSIONS	DIMENSIONS / MEDIDAS / MEASUREMENTS	RÉFÉRENCE / REFERENCIA / CODE
	120 x 60 cm 95 x 95 cm 66 x 66 cm	82.930.-.- 82.950.-.- 82.910.-.-
FINITIONS ACABADOS FINISHES		
	054 Gris Gris Grey 116 Wengué Wengué Wengué	055 Hêtre Haya Beech 103 Acacia Clair Acacia Clara Light Acacia
		061 Chêne Moyen Roble Maple 104 Acacia Foncé Acacia Oscura Dark Acacia
		062 Poirier Peral Pear 105 Zebano Zebano Zebano
Structure Armazón Frame	Noire Negro Black Chromée Cromado Chrome	
	RAL 9005	

Tables basses
Mesas de centro
Coffee tables



Tissus Tapizados Upholstery

Les procédés d'impression ne permettent pas une reproduction exacte des tonalités originales. Pour plus de fiabilité, veuillez consulter le nuancier tissu.

Los procedimientos de impresión no permiten una reproducción exacta de las tonalidades originales. Para una máxima fiabilidad consultar el catálogo de telas.

Printing procedures do not provide an exact reproduction of original colour tones. Please check the fabric sample book.

Aran



A.308 A.430 A.300 A.933 A.261



A.229 A.200 A.529 A.600 A.840

Fiji



FI300 FI308 FI312 FI305 FI311



FI301 FI313

Lava

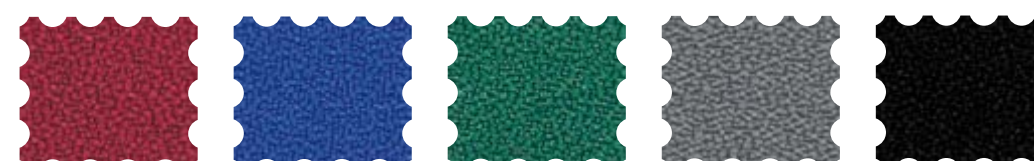

LA003 LA002 LA004 LA005 LA001

Only



ONL01 ONL02 ONL03 ONL04

Série 1
Serie 1
Serie 1

Série 1
Serie 1
Serie 1

Série 1
Serie 1
Serie 1

Série 1
Serie 1
Serie 1

Série 1
Serie 1
Serie 1



Série 1
Serie 1
Serie 1

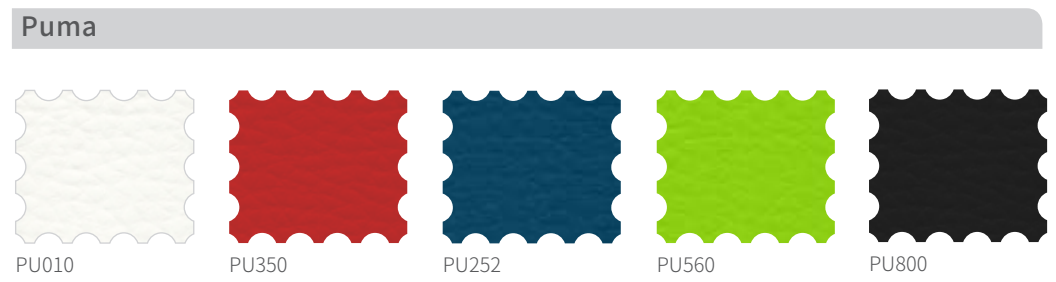

Série 1
Serie 1
Serie 1



Série 1
Serie 1
Serie 1

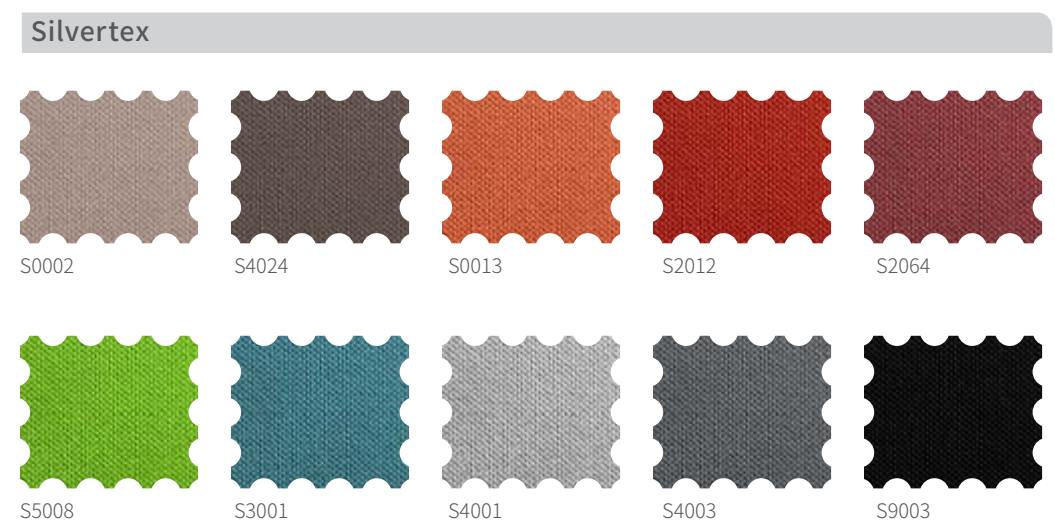
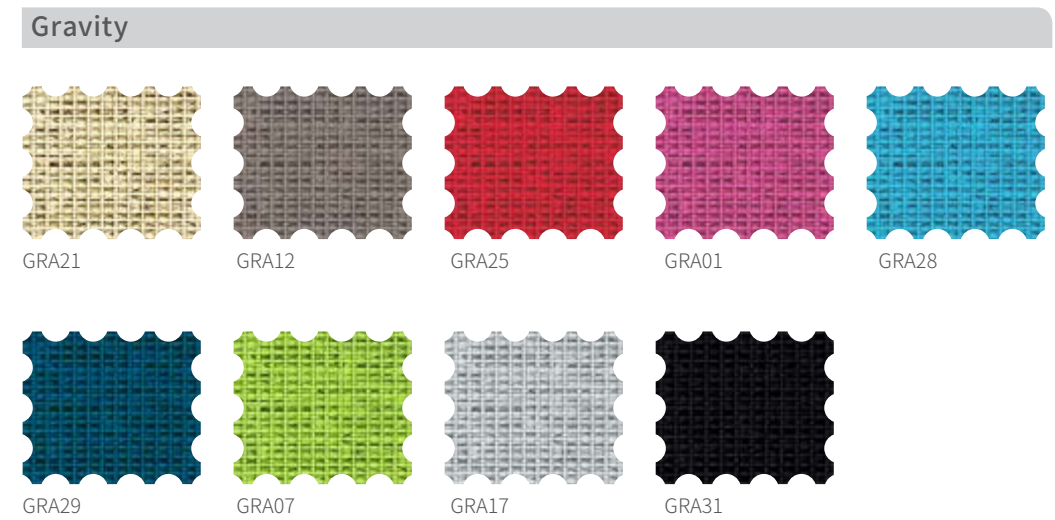
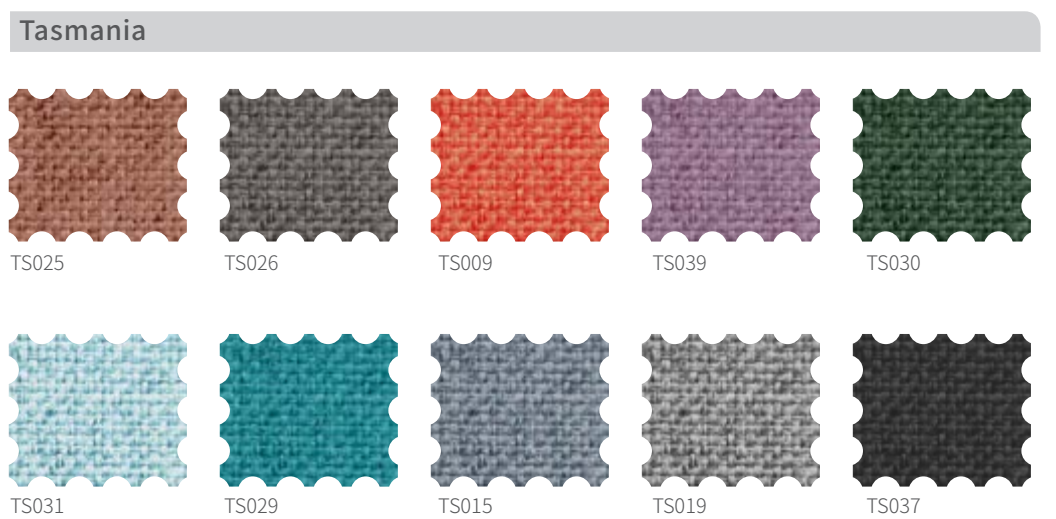

Série 4
Serie 4
Serie 4

Série 4
Serie 4
Serie 4

Série 4
Serie 4
Serie 4

Série 4
Serie 4
Serie 4

Danzica



DA054

DA008

DA063

DA034

DA041



DA046

DA048

DA042

DA064

DA023

Série 4
Serie 4
Serie 4

Vigo



VI103

VI100

VI400

VI302

VI200

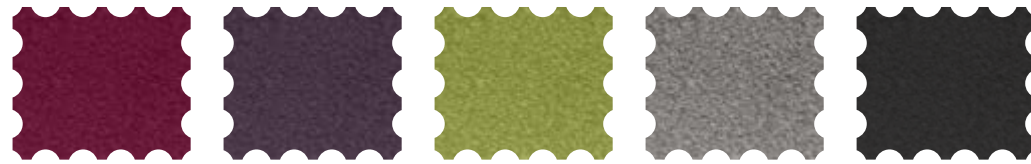

VI701

VI702

VI502

VI802

VI800

Série 4
Serie 4
Serie 4

Evolve



EVO00

EVO077

EVO021

EVO028

EVO090

Série 7
Serie 7
Serie 7

Leather



P.179

P.129

P.102

P.115

P.103



MOBEL LINEA

Ctra. de Guissona, km 1
25200 CERVERA (Lleida) SPAIN
mobel@mobellinea.es
www.mobellinea.com



Mobel Linea, S.L. se réserve le droit de modifier les caractéristiques techniques des produits sans préavis en les adaptant au progrès technique. Les procédés d'impression ne permettent pas une reproduction exacte des tonalités originales. Pour plus de fiabilité, veuillez consulter le nuancier finitions. Textes, photos et illustrations non contractuels. / Mobel Linea, S.L. se reserva el derecho a introducir en estos productos sin previo aviso, las mejoras técnicas derivadas de su constante investigación. Los procedimientos de impresión no permiten una reproducción exacta de las tonalidades originales. Para una máxima fiabilidad consultar los catálogos de acabados. / Mobel Linea, S.L. reserves all rights to make technical changes and improvements at any time resulting from his ongoing research, without previous notice. Please bear in mind the actual finish may be slightly different. Since the printing does not show 100% the real colors. To make sure please look at our catalogue finishes.

ML-2019/09