

ORT HOS

inclusive solutions
MOBILITY

MOBILITY

Robustness
Modularity
Customization



HISTORY

Orthos XXI originated from Conrado Dias Lda., a company founded in 1975 in Porto, Portugal.

In 1985, with great support from the owners Mr. Dias and Mrs. Marília, that the Mr. Ribeiro and Mrs. Zilda, decide to give continuity to the business of production and commercialization of walking aids, with the name of Ortomaia, thus concretizing an old aspiration of the Sñr. Ribeiro owning a business. This new company has the assiduous collaboration of Manuel and Luisa and with the timely help of their other children, thus naturally involving the whole family in the process. The bases that make up the current dynamic of Orthos XXI were launched, based on values of affection and proximity among all generations of collaborators.

Together with the production activity, the distribution of products from national and international companies of great importance in the Sector is included in its portfolio.

In 1989, a wheelchair production unit was acquired and integrated, giving rise to two independent and distinct production units, but with joint commercialization.

In 1996 it was necessary to expand, integrate and fully optimize the business, so it was built in Guimarães, a new warehouse with twice the area to accommodate all the aspects of the business. With a view to the expansion and evolution of the activity, in 2007 Several decisive steps are taken:

A process of professionalization of management begins by separating the shareholder structure from the management structure, thus formally creating Orthos XXI.

A production unit for Geriatric and Hospital beds was installed and the facilities for the double were expanded again.

Direct participation in the Spanish market began, creating a commercial structure, OrthosMaia XXI, in Spain.

They initiate and develop several commercial actions to expand and develop new markets and new businesses.

In 2012, a consolidation and product development department was created, which, together with the continuous improvement of the Organization, has allowed the product range to be substantially expanded.

In 2017/18 Orthos XXI, reformulates its marketing and commercial strategy, organizing its product portfolio in ten brands. We have a base with a productive DNA that allows us to continue production in Europe and a brand-oriented trade strategy to be able to face the competition of multinationals and Asian importers.

QUALITY

The quality of the ORTHOS XXI products can be confirmed in the best hospitals and institutions, where they have chosen us. Most of our products are class I medical devices and bear the CE mark, according to the Community Directives 93/42/CEE and 2007/47/CE and are registered in the competent Authority, Infarmed. They are tested by accredited and independent entities, such as the IBV (Institute of Biomechanics of Valencia, in Spain). The company is also certified according to the EN ISO 9001 standard.

The value and qualification of human resources through the implementation of activity is training and updating in different areas have been strong bets of our company. ORTHOS XXI's main concern is the continuous improvement of production processes and services, as well as the improvement of the quality of its products, which allows us to better meet the needs and requirements of customers and users.



**ORT
HOS**
XXI
european
inclusive solutions

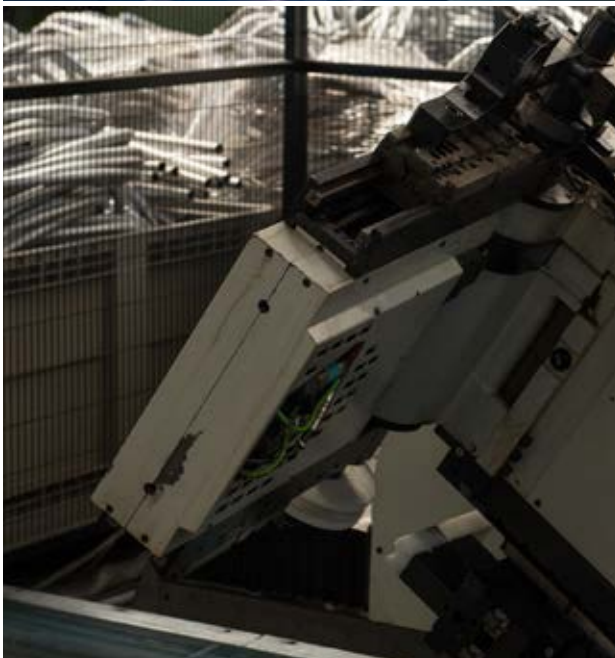

VALUE

We are driven by the conviction that, with our work, we contribute daily to improve the quality of life and to satisfy the needs of the users of our products and services. We prioritize an attitude of teamwork, flexibility and continuous improvement. We consider fundamental a constant investment in innovation and development of the products, currently counting on a team dedicated exclusively to this purpose.

These values support the presentation, in this new catalog, of some of the most recently developed novelties and, at the same time, to respond to the personalized needs of the users.



MANUAL STEEL WHEELCHAIRS

Celta Compact 3, Celta, Celta Evolution, Celta Bed, Celta Command, Celta Recoil, Peninsular, Lusa, Ibera, Accesorios & Opciones

pag 5-15

MANUAL ALUMINUM WHEELCHAIRS

Latina Compact, Latina, Latina Advance, Ativa Invictus, Ativa Sioux

pag 17-21

POSITIONING WHEELCHAIRS

Caribe, Caribe Advance

pag 23-25

POWER WHEELCHAIRS

Azteca, Inca, Inca Plus, Vicking, Vicking Advance, Vicking Suspension

pag 27-31

SCOOTERS

Liberty, Eco, Compact Deluxe, Extra, XXL

pag 33-34

OTHER SOLUTIONS

Maia, Plane, Auxiliary Motor

pag 36-37

INTERIOR WHEELCHAIRS

Commode, Comfort Light, Andalus Fix, Andalus Foldable, Andalus Recline, Comfort Plus

pag 39-42





CELTA COMPACT 3	Pag 06
CELTA	Pag 07
CELTA EVOLUTION	Pag 08
CELTA BED	Pag 09
CELTA COMMAND	Pag 10
CELTA RECOIL	Pag 10
PENINSULAR	Pag 11
LUSA	Pag 12
IBERA	Pag 13

CELTA COMPACT 3



CELTA COMPACT 3, a resistant and functional wheelchair made of steel. Structure in blue with black upholstery. Removable and reversible armrests so the user can have more freedom in movement. Removable and height adjustable footrests. Ø25mm tubes and triple cross bar for enhanced robustness. Solid back wheels with nylon rims and Ø600mm or Ø300mm (transit).



51 CD C3 2 NO 43 NM
CELTA COMPACT3 43 (600mm spokes / 200mm solid)

TECHNICAL CHARACTERISTICS



Triple cross bar



Removable footrest



Removable armrests

CELTA COMPACT 3

Colour - structure	blue
Colour - upholstery	black
Available sizes	40/43/46cm
Front wheels - solid	Ø200mm
Back wheels - solid	Ø600mm/Ø300mm
Rear rims	nylon
Weight without desmountable components	11kg/12,2kg

MEASUREMENTS

in cm/kg- tolerance +/-1

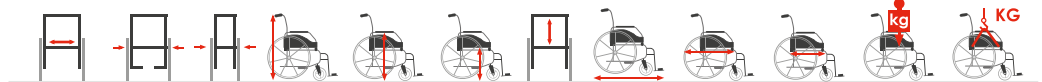

	40	61	32	92	72	51	41	101	83	42	150	14,6
CELTA COMPACT 3 40	40	61	32	92	72	51	41	101	83	42	150	14,6
CELTA COMPACT 3 43	43	64	32	92	72	51	41	101	83	42	150	14,8
CELTA COMPACT 3 46	46	67	32	92	72	51	41	101	83	42	150	15,0
CELTA COMPACT 3 TRANSIT 40	40	56	31	92	72	49	41	94	76	42	150	12,4
CELTA COMPACT 3 TRANSIT 43	43	59	31	92	72	49	41	94	76	42	150	13,6
CELTA COMPACT 3 TRANSIT 46	46	62	31	92	72	49	41	94	76	42	150	13,8



CELTA, wheelchair with attractive and flexible design, modern and robust structure. Ø25mm tubes and triple cross bar for extra robustness. Removable armrest with an attractive and flexible design. Removable and height adjustable footrest. Ø600mm rear wheels with quick release (except size 50) for easy transport. See accessories and options.



51 CD CE 2 NO 40 NM
CELTA 40 (600mm nylon solid / 200mm solid)

CELTA

- Colour - structure
grey
- Colour - upholstery
black
- Available sizes
37/40/43/46/50cm
- Front wheels - solid
Ø200mm
- Back wheels - solid/pneumatic
Ø300mm/ Ø600mm
- Rear rims
spokes/nylon
- Weight without desmountable components
8,6kg

TECHNICAL CHARACTERISTICS



Foldable



Triple cross bar



Wheels Ø300mm

MEASUREMENTS

in cm/kg- tolerance +/-1

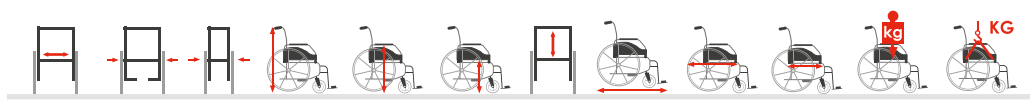

	Seat width	Seat depth	Seat height	Back height	Wheel diameter	Weight
CELTA 37	37	57	28	93	73	51
CELTA 40	40	60	28	93	73	51
CELTA 43	43	63	28	93	73	51
CELTA 46	46	66	28	93	73	51
CELTA 50	50	69	28	93	73	51
CELTA TRANSIT 37	37	54	30	93	73	51
CELTA TRANSIT 40	40	57	30	93	73	51
CELTA TRANSIT 43	43	60	30	93	73	51
CELTA TRANSIT 46	46	63	30	93	73	51
CELTA TRANSIT 50	50	66	30	93	73	51

CELTA EVOLUTION



51 CD CV 2 NO 40 EM

CELTA EVOLUTION 40 (600mm spokes solid / 200mm solid)

CELTA EVOLUTION is a manual steel wheelchair with attractive design, functionality and robustness. Suitable for users with general mobility decrease, it is a sturdy and durable chair, practical to use on a day-to-day basis. In addition, it allows various configurations and the inclusion of a wide range of accessories to better adjust to the condition of the user, over time. Reinforced structure with tubes of 25mm diameter and triple cross for greater resistance. Folding armrests support for easy transfer. Height-adjustable footrests with bilateral opening. Fire resistant upholstery in accordance with EN 1102: 1995. Rear wheels 600mm with aluminum rim, pneumatic or solid. Nylon or spoke rims. Solid 200x30mm front wheels (option: pneumatic wheels 200x50mm). Easy to carry, easy to attach and has quick release of rear wheel (exception: size 50 has no quick release). Seat width: 370, 400, 430, 460mm. Maximum user weight: 150 kg.

CELTA EVOLUTION

Colour - structure	red
Colour - upholstery	black
Available sizes	40/43/46cm
Front wheels - solid	Ø200mm
Back wheels	Ø600mm
Rear rims	spokes/nylon
Weight without desmountable components	8,6kg



MEASUREMENTS

in cm/kg- tolerance +/-1

CELTA EVOLUTION 40	40	62	28	92	71,5	51	43,5	105	81	42	150	16,5
CELTA EVOLUTION 43	43	65	28	92	71,5	51	43,5	105	81	42	150	16,5
CELTA EVOLUTION 46	46	68	28	92	71,5	51	43,5	105	81	42	150	16,5

Suitably reinforced to provide the user the comfort of a chair with bed function with smooth and safe pistons for manual recline. Nylon upholstery. Armrests removable and reversible. with reclining backrest from 93° to 150° and elevating legrests, allows the user to put up in full position, comfortably. See accessories and options.



51 CD CE 2 CM 40 EM
CELTA Bed 40 (600mm spokes solid/200mm solid)

CELTA BED

Colour - structure	grey
Colour - upholstery	black
Available sizes	37/40/43/46/50cm
Front wheels - solid	Ø200mm
Back wheels - solid/pneumatic	Ø600mm/Ø300mm
Rear rims	spokes
Weight without desmountable components	20kg

TECHNICAL CHARACTERISTICS



Reclining system



Removable headrest



Triple cross bar



Elevating footrests

MEASUREMENTS

in cm/kg- tolerance +/-1

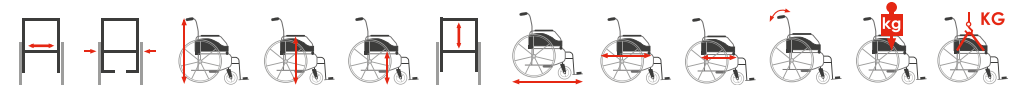

	37	40	43	46	50	51	58(+15)	125-150	90	44	93°-150°	125	23,8
CELTA BED 37	37	57	110-125	73	51	58(+15)	125-150	90	44	93°-150°	125	23,8	
CELTA BED 40	40	60	110-125	73	51	58(+15)	125-150	90	44	93°-150°	125	24,0	
CELTA BED 43	43	63	110-125	73	51	58(+15)	125-150	90	44	93°-150°	125	24,2	
CELTA BED 46	46	66	110-125	73	51	58(+15)	125-150	90	44	93°-150°	125	24,4	
CELTA BED 50	50	69	110-125	73	51	58(+15)	125-150	90	44	93°-150°	125	24,6	
CELTA BED TRANSIT 37	37	54	110-125	73	51	58(+15)	125-150	90	44	93°-150°	125	25,3	
CELTA BED TRANSIT 40	40	57	110-125	73	51	58(+15)	125-150	90	44	93°-150°	125	25,5	
CELTA BED TRANSIT 43	43	60	110-125	73	51	58(+15)	125-150	90	44	93°-150°	125	25,7	
CELTA BED TRANSIT 46	46	63	110-125	73	51	58(+15)	125-150	90	44	93°-150°	125	25,9	
CELTA BED TRANSIT 50	50	66	110-125	73	51	58(+15)	125-150	90	44	93°-150°	125	26,1	

CELTA COMMAND



With the structural characteristics of CELTA, this is the solution for driving with only one hand. Dual wheel for easy pulling and driving single handed. Suitable for hemiplegic users.

CELTA COMMAND

Colour - structure	grey
Colour - upholstery	black
Available sizes	37/40/43/46/50cm
Front wheels - solid	Ø200mm
Back wheels - pneumatic	Ø600mm
Rear rims	spokes
Weight without desmountable components	15,1kg

51 CD CE 2 CO 40 ED D

CELTA Command right 40 (600mm pneumat/200mm solid)

MEASUREMENTS

in cm/kg- tolerance +/-1

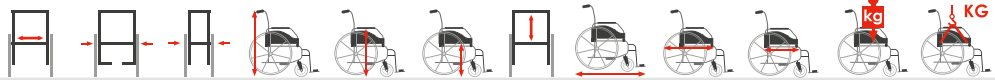

CELTA COMMAND 37	37	67	28	92	72	45	43	101	78	42	125	17,5
CELTA COMMAND 40	40	60	28	92	72	45	43	101	78	42	125	17,7
CELTA COMMAND 43	43	63	28	92	72	45	43	101	78	42	125	17,9
CELTA COMMAND 46	46	66	28	92	72	45	43	101	78	42	125	18,1
CELTA COMMAND 50	50	69	28	92	72	45	43	101	78	42	125	18,3

CELTA RECOIL



With CELTA RECOIL, the center of gravity is behind to allow proper balance, for example for an amputee. Two possible points of recoil (10 and 15cm) from the normal axle. See accessories and options.

CELTA RECOIL

Color - estructura	grey
Colour - upholstery	black
Available sizes	37/40/43/46/50cm
Front wheels - solid	Ø200mm
Back wheels - pneumatic	Ø600mm
Rear rims	spokes
Weight without desmountable components	15,5kg

51 CD CE 2 ER 40 ED

CELTA Eje Retrasado 40 (rd 600 hinchabl/200 maciz)

MEASUREMENTS

in cm/kg- tolerance +/-1

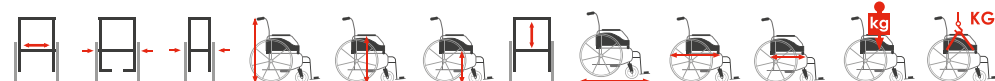

CELTA RECOIL 37	37	59	28	92	72	51	40	110/115	88/93	42	150	17,5
CELTA RECOIL 40	40	62	28	92	72	51	40	110/115	88/93	42	150	17,7
CELTA RECOIL 43	43	65	28	92	72	51	40	110/115	88/93	42	150	17,9
CELTA RECOIL 46	46	68	28	92	72	51	40	110/115	88/93	42	150	18,1
CELTA RECOIL 50	50	71	28	92	72	51	40	110/115	88/93	42	150	18,3



51 CD PN 2 NO 54 ED

PENINSULAR 54 (radios 600mm pneumatic/200mm solid)

PENINSULAR

Colour - structure	grey
Colour - upholstery	black
Available sizes	37/40/43/46/50cm
Front wheels - solid	Ø200mm
Back wheels - pneumatic	Ø600mm/ Ø300mm
Weight without desmountable components	17kg

Because not all have the same size! PENINSULAR offers the user an adaptable wheelchair to your size and even more adaptable to your needs. With reinforced triple cross bar and upholstery for robustness. Allows to apply all CELTA accessories range making it a great adaptable chair, for large sizes, large solutions. With capacity up to 160kg. We manufacture customized according to the size and weight of the user's size and weight. Check also our bariatric line (up to 250kg). See accessories and options.



Wider footrests



Detachable armrests



Reinforced triple cross bar



Foldable



Parking brake

MEASUREMENTS

in cm/kg- tolerance +/-1

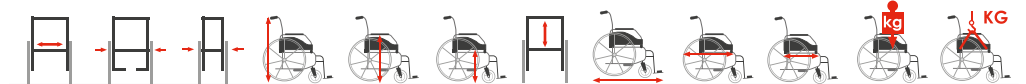

	1	2	3	4	5	6	7	8	9	10	11	12
PENINSULAR 54	54	74	28	92	72	51	41	100	78	42	160	19,0
PENINSULAR 58	58	78	28	92	72	51	41	100	78	42	160	20,0
PENINSULAR TRANSIT 54	54	71	30	92	72	51	41	94	72	42	160	17,3
PENINSULAR TRANSIT 58	58	75	30	92	72	51	41	94	72	42	160	18,3



LUSA has quick release in the rear wheels, easy for transport; with transfer castors suitable for small indoor spaces. Because you deserve to feel good wherever you are, it includes an anatomical memory foam seat.

See accessories and options.



51 CD LU W NO 40 ED

LUSA 40 (spokes 600/200mm pneumatic) Anatómic seat

TECHNICAL CHARACTERISTICS

LUSA

Colour - structure	grey
Colour - upholstery	black
Available sizes	40/43/46cm
Front wheels - solid	Ø200mm
Back wheels - pneumatic	Ø600mm
Castors	Ø75mm
Rear rims	spokes
Weight without desmountable components	10kg



Memory foam pad



Transfer wheels



Footrests



Removable armrests



Foldable

MEASUREMENTS

in cm/kg- tolerance +/-1

	40	43	46	Seat height	Seat depth	Seat width	Back height	Wheelchair height	Wheelchair width	Wheelchair depth	Weight	Weight
LUSA 40	40	51-59	29	92	72	51	42	94/100	78	42	150	17,5
LUSA 43	43	54-62	29	92	72	51	42	94/100	78	42	150	17,7
LUSA 46	46	57-65	29	92	72	51	42	94/100	78	42	150	17,9

IBERA was designed to be adaptable to the needs of each individual. Ø25mm tubes and triple cross bar for extra robustness. The partial tensioning bands at the backrest and the suspension system in the structure provide additional comfort. Ø200mm solid front wheels (Option: pneumatic) and Ø600mm or solid rear wheels with quick release, also available Ø300mm solid rear wheels. Simple, lightweight, and versatile.



51 CD IB 2 NO 39 EM
IBERA 39 (600mm spokes solid / 200mm solid)

IBERA

Colour - structure	white
Colour - upholstery	black
Available sizes	39/42/45cm
Front wheels - solid	Ø200mm
Back wheels - solid/pneumatic	Ø600mm/Ø300mm
Rear rims	spokes/nylon
Weight without desmountable components	10,2kg/11,8kg

TECHNICAL CHARACTERISTICS



Suspension system



Triple cross bar



Bag



Foldable



Detachable armrests



Tension adjustable back

MEASUREMENTS

in cm/kg- tolerance +/-1

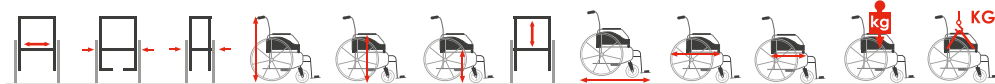

IBERA 39	39	60	31	92	72	52	39	102	78	42	150	17,2
IBERA 42	42	63	31	92	72	52	39	102	78	42	150	17,4
IBERA 45	45	65	31	92	72	52	39	102	78	42	150	17,6
IBERA TRANSIT 39	39	57	33	92	72	52	39	96	72	42	150	15,4
IBERA TRANSIT 42	42	60	33	92	72	52	39	96	72	42	150	15,6
IBERA TRANSIT 45	45	62	33	92	72	52	39	96	72	42	150	15,8

ACCESSORIES & OPTIONS

Headrest



Headrest



U shape headrest



Contoured headrest



Back stretcher

Armrests



Height adjust. armrests



Long armrests



Simple folding armrests



Complete folding armrests

Footrests



Leg rest



Elevating legrests



Aluminum footrests



One-piece footrest

Back and Seat



PU cover lateral support comfort back



3D cover lateral support comfort back



Shoulder support comfort back



Lumbar support comfort back



Lumbar support soft back



Comfort back 100mm extension



Comfort back 200mm extension



Rigid back



Adjust. total tensioning back 3D cover



Folding back



Reclining back (gas piston)



Reclining back (manual)



Adjust. partial tensioning back



Rigid seat

ACCESSORIES & OPTIONS



Anatomic sanitary seat



ABS sanitary seat



Soft seat 70mm cushion
3D cover



Soft seat 70mm cushion
PU cover



Soft seat 80mm cushion
3D cover



Soft seat 80mm cushion
PU cover

Wheels



Pneumatic front wheels



Solid front wheels



300mm pneumatic rear
wheel



300mm solid rear wheel



600mm rear pneum
spokes wheel



600mm rear pneum.
nylon wheel



600mm rear solid nylon
wheel



Rim with 8 supports



Anti-tipping wheels



Transfert kit

Others



Amputee support



Attendant's brake



Serum support



Trunk support



Abductor



Rain coat



Safety belt



Oxygen support



Acrilic board



Wood board

MANUAL ALUMINUM WHEELCHAIRS

LATINA COMPACT Pag 17

pag 17-21

LATINA Pag 18

LATINA ADVANCE Pag 19

ATIVA INVICTUS Pag 20

ATIVA SIOUX Pag 21

LATINA COMPACT



LATINA COMPACT, lightweight and compact aluminium wheelchair with triple cross bar. White or grey structure and black upholstery. Other upholstery colour options: lilac, pistachio, dark green and cream (additional cost). Folding armrest; detachable and height adjustable foot rest. In 3 sizes, 40, 43 and 46cm with quick release Ø600mm (spokes rims) and Ø300mm (transit) wheels.



51 CD LC 2 NO 40 EM

LATINA COMPACT 40 (600mm spokes solid/200mm solid)

LATINA COMPACT

Colour - structure	white, grey
Colour - upholstery	lilac, pistachio, dark green, cream
Available sizes	40/43/46cm
Front wheels - solid	Ø200mm
Back wheels - pneumatic	Ø600mm/Ø300mm
Rear rims	spokes
Weight without desmountable components	7,4kg

TECHNICAL CHARACTERISTICS



Foldable



Adjustable footrests



Folding armrests



Cream



Lilac



Pistachio



Dark green

MEASUREMENTS

in cm/kg- tolerance +/-1

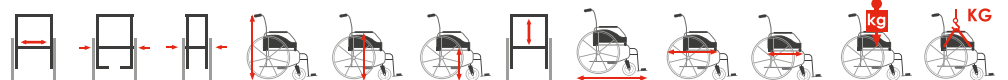

	40	58	29	92	72	51	41	106	83	42	125	12,0
LATINA COMPACT 40	40	58	29	92	72	51	41	106	83	42	125	12,0
LATINA COMPACT 43	43	60	29	92	72	51	41	106	83	42	125	12,1
LATINA COMPACT 46	46	63	29	92	72	51	41	106	83	42	125	12,2
LATINA COMPACT TRANSIT 40	40	58	29	92	72	51	41	97	76	42	125	14,0
LATINA COMPACT TRANSIT 43	43	60	29	92	72	51	41	97	76	42	125	14,1
LATINA COMPACT TRANSIT 46	46	63	29	92	72	51	41	97	76	42	125	14,2

LATINA



51 CD LA 2 NO 40 EM

LATINA 40 (600mm spokes solid / 200mm solid)

LATINA, lightweight aluminium wheelchair with triple cross bar and an attractive design. White or grey structure and black upholstery. Folding armrest (option: removable) and detachable and height adjustable foot rest, detachable. Available in 5 sizes, 37, 40, 43, 46 and 50cm with Ø600mm (spokes rims) with quick release (except size 50cm) or Ø300mm(transit) wheels. Upholstery colour options: lilac, pistachio, dark green and cream. See accessories and options.

LATINA

Colour - structure	white, grey
Colour - upholstery	black, lilac, pistachio, dark green, cream
Available sizes	37/40/43/46/50cm
Front wheels - solid	Ø200mm
Back wheels	Ø600mm/Ø300mm
Rear rims	spokes
Weight without desmountable components	7,6kg/13,1kg



Foldable



Adjustable footrests



Folding armrests



MEASUREMENTS

In cm/kg- tolerance +/-1

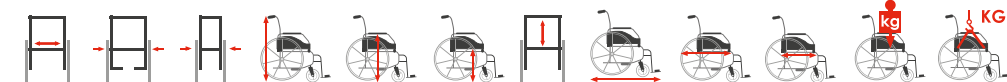

	37	40	43	46	50	37	40	43	46	50	kg	kg
LATINA 37	37	57	30	93	72	51	41	100	77	42	125	12,4
LATINA 40	40	60	30	93	72	51	41	100	77	42	125	12,5
LATINA 43	43	63	30	93	72	51	41	100	77	42	125	12,6
LATINA 46	46	66	30	93	72	51	41	100	77	42	125	12,7
LATINA 50	50	70	30	93	72	51	41	100	77	42	125	12,8
LATINA TRANSIT 37	37	54	30	93	72	51	41	96	70	42	125	13,9
LATINA TRANSIT 40	40	57	30	93	72	51	41	96	70	42	125	14,0
LATINA TRANSIT 43	43	60	30	93	72	51	41	96	70	42	125	14,1
LATINA TRANSIT 46	46	63	30	93	72	51	41	96	70	42	125	14,2
LATINA TRANSIT 50	50	67	30	93	72	51	41	96	70	42	125	14,3

LATINA ADVANCE



51 CD LD 2 NO 40 ED

LATINA ADVANCE 40 (spokes 600 pneumatic/150 solid)

LATINA ADVANCE

Colour - structure	white
Colour - upholstery	black
Available sizes	37/40/43/46/50cm
Front wheels - solid	Ø200mm
Back wheels - solid	Ø600mm/Ø300mm
Rear rims	spokes
Weight without desmountable components	9,2kg

LATINA ADVANCE, height and depth adjustable aluminium wheelchair with Ø25mm tubes and triple crossbar for robustness. White structure and black upholstery. Colour options: lilac, pistachio, cream and dark green. Height and depth adjustable armrests. Removable footrests with bilateral opening. Height adjustable backrest with tensioning bands and depth adjustable seat. Folding backrest (option) reducing the overall size of the chair when folded for easy transport and storage. Available in 5 sizes, 37, 40, 43, 46 and 50cm with Ø600mm (spokes rims) with quick release (except size 50cm) or Ø300mm(transit) wheels. See accessories and options.



Folding back (option)



Adjustable seat depth



Lower back tension bands



Seat belt (accessory)



Adjustable

MEASUREMENTS

In cm/kg- tolerance +/-1



	37	40	43	46	50	37	40	43	46	50	37	40	43	46	50	37	40	43	46	50	37	40	43	46	50
LATINA ADVANCE 37	37	57	30	92	68-76	51	41	103	82	42	125	125	125	125	125	125	125	125	125	125	125	125	125	125	125
LATINA ADVANCE 40	40	60	30	92	68-76	51	41	103	82	42	125	125	125	125	125	125	125	125	125	125	125	125	125	125	125
LATINA ADVANCE 43	43	63	30	92	68-76	51	41	103	82	42	125	125	125	125	125	125	125	125	125	125	125	125	125	125	125
LATINA ADVANCE 46	46	66	30	92	68-76	51	41	103	82	42	125	125	125	125	125	125	125	125	125	125	125	125	125	125	125
LATINA ADVANCE 50	50	70	30	92	68-76	51	41	103	82	42	125	125	125	125	125	125	125	125	125	125	125	125	125	125	125
LATINA ADVANCE TRANSIT 37	37	54	30	92	68-76	51	41	96	75	42	125	125	125	125	125	125	125	125	125	125	125	125	125	125	125
LATINA ADVANCE TRANSIT 40	40	57	30	92	68-76	51	41	96	75	42	125	125	125	125	125	125	125	125	125	125	125	125	125	125	125
LATINA ADVANCE TRANSIT 43	43	60	30	92	68-76	51	41	96	75	42	125	125	125	125	125	125	125	125	125	125	125	125	125	125	125
LATINA ADVANCE TRANSIT 46	46	63	30	92	68-76	51	41	96	75	42	125	125	125	125	125	125	125	125	125	125	125	125	125	125	125
LATINA ADVANCE TRANSIT 50	50	67	30	92	68-76	51	41	96	75	42	125	125	125	125	125	125	125	125	125	125	125	125	125	125	125

ATIVA INVICTUS



51 CD SA 2 NO 40 ED

ATIVA INVICTUS 40 (spokes 600mmpneumatic/100mmsolid)

ATIVA INVICTUS, resistant and functional Ø25mm tubes and triple cross bar wheelchair made of aluminium. Structure with height and depth adjustments. Height and tension adjustable upholstery, with memory foam and 3D cover. Height adjustable independent foot rests. Pneumatic back wheels with quick release for easy storage and transport. See accessories and options.

ATIVA INVICTUS

Colour - structure	red, blue, white
Colour - upholstery	black
Available sizes	37/40/43/46cm
Front wheels - solid	Ø150mm
Back wheels - solid	Ø600mm
Rear rims	spokes
Weight without desmountable components	9,6kg



Adjustable back



Armrests (option)



Side pannels



Adjustable depth



Easy storage

MEASUREMENTS

in cm/kg- tolerance +/-1



ATIVA INVICTUS 40	40	58	30	89-99	73	51	34-44	91	42-44	125	9,6
ATIVA INVICTUS 43	43	61	30	89-99	73	51	34-44	91	42-44	125	9,6
ATIVA INVICTUS 46	46	64	30	89-99	73	51	34-44	91	42-44	125	9,6



51 CD SI 2 NO 40 ED

ATIVA SIOUX 40 (spokes 600mmpneumatic/100mmsolid)

ATIVA SIOUX

Colour - structure	grey, black, blue, red
Colour - upholstery	black
Available sizes	40/43/46cm
Front wheels - solid	Ø100mm
Back wheels - solid	Ø600mm
Rear rims	spokes

ATIVA SIOUX, active and light wheelchair made of aluminium (weight without wheels: 7,2Kg). Rigid chassis, resistant and functional. Height and depth adjustments. Solid back and seat. Back and seat memory foam cushions for maximum comfort. Foldable backrest, angle adjustable. Height, depth and angle adjustment of the seat. One piece footrest height adjustable. Side panels. Pneumatic 600mm rear wheels with quick release and spoke rims allows easy storage and transport. 100mm solid front wheels. Seat width: 37, 40, 43, 46, 50cm. Maximum user weight: 125Kg.



Adjustable to the user



Folding backrest



Ergonomic



Easy storage

MEASUREMENTS

in cm/kg- tolerance +/-1



	1	2	3	4	5	6	7	8	9	10	11	12
ATIVA SIOUX 40	40	58	30	89-99	73	51	34-44	91	42-44	125	9,6	
ATIVA SIOUX 43	43	61	30	89-99	73	51	34-44	91	42-44	125	9,6	
ATIVA SIOUX 46	46	64	30	89-99	73	51	34-44	91	42-44	125	9,6	

POSITIONING WHEELCHAIRS

CARIBE

Pag 23

pag 23-25

CARIBE ADVANCE

Pag 24



CARIBE



CARIBE, positioning chair that provides maximum adaptability to the user needs. Made of steel, with pneumatic recline (89° to 114° or 96° to 120°) and tilt (0° a 30° or - 5° a 25°). Ensures correct positioning and user 's safety. Height adjustable rigid back with Comfort Back lateral cushion. The seat is adjustable in depth (400mm to 500mm), width (up to 5cm) and angle with Comfort Seat cushion. Height adjustable handles. Height and depth adjustable armrests, elevating footrests and anti-tipping wheels. U shape headrest adjustable in height and angle. Option: manual tilt and recline; Ø300mm or Ø600mm back wheels. Wide range of accessories and options.



51 CD PO CR 40
CARIBE 40

TECHNICAL CHARACTERISTICS



Anti tipping wheels



Headrest



Rigid backrest



Elevating footrests



Rigid seat

CARIBE

- Colour - structure
white, grey
- Colour - upholstery
black
- Available sizes
40/43/46/50cm
- Front wheels - solid
Ø200mm
- Back wheels - solid
Ø600mm/Ø300mm
- Rear rims
spokes/nylon
- Weight without desmountable components
32,5kg
- Seat's depth adjustment
40-50cm
- Recline
89° - 114° (mechanical)/96° - 120° (pneumatic)
- Pneumatic tilt
0° - 30° / -5° - 25°

MEASUREMENTS

in cm/kg - tolerance +/-1



CARIBE 40	40	58/66	110-129	66-78	47-51	55-70	104-114	90	40-45	96°-120°	0°-30°	150	40,5
CARIBE 43	43	58/66	110-129	66-78	47-51	55-70	104-114	90	40-45	96°-120°	0°-30°	150	40,5
CARIBE 46	46	61/66	110-129	66-78	47-51	55-70	104-114	90	40-45	96°-120°	0°-30°	150	40,5
CARIBE 50	50	65/67	110-129	66-78	47-51	55-70	104-114	90	40-45	96°-120°	0°-30°	150	40,5



51 CD PO CR 40 50
CARIBE ADVANCE

CARIBE ADVANCE

Colour - structure	grey, white
Colour - upholstery	black
Available sizes	40/43/46/50cm
Front wheels - solid	Ø200mm
Back wheels	Ø300mm/Ø400mm/Ø600mm
Rear rims	spokes/nylon
Weight without desmountable components	33kg
Seat's depth adjustment	40-50cm
Adjustable seat's width	40-50cm
Recline pneumatic	89° - 114°/96° - 120°
Pneumatic tilt	0° - 30°/-5° - 25°

TECHNICAL CHARACTERISTICS



Adjustable armrests



Headrest



Anti tipping wheels



Elevating footrests



Attendant's drum brake



Parking brake

CARIBE ADVANCE positioning wheelchair adjustable to the user needs, providing numerous points of attachment to the seat and backrest.

Made of steel, with pneumatic recline (0° to 30° or - 5° to 25°) and tilt (89° to 114° or 96° to 120°). Also available with mechanic tilt and recline. Fully modular seating system with adjustable and separate plates allowing extensive adjustments in width, depth and height.

Height adjustable rigid back plate with 2 tension lower back straps with lateral Comfort Back cushion. Adjustable rigid seat, in depth (from 400mm to 500mm), width (400mm to 500mm) and angle (1° to 30° or - 5° to 25°) with Comfort Seat cushion. Several options available for seat and backrest cushions. Height adjustable handles and transport kit with 4 fixation points for transport.

Equipped with Ø400mm solid rear wheels and Ø200mm front solid wheels. Parking and attendant 's brakes. T shape armrests adjustable in height and depth with Comfort pad. Elevating footrests with side opening and depth adjustment (50mm). Adjustable and removable anti-tipping wheels. U shape headrest adjustable in height, angle and depth. Wide range of accessories and options available.



Foldable



Rigid backrests with tension back straps



Adjustable rigid seat

MEASUREMENTS

in cm/kg- tolerance +/-1

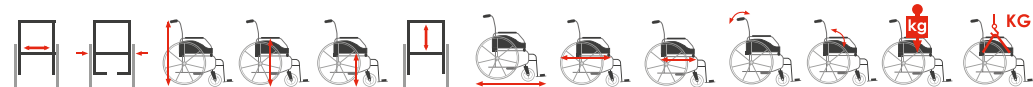

CARIBE ADVANCE 40	40-50	58/66	110-129	66-78	47-51	55-70	104-114	90	40-45	89°-114°	0°-30°	150	41
CARIBE ADVANCE 43	40-50	58/66	110-129	66-78	47-51	55-70	104-114	90	40-45	89°-114°	0°-30°	150	41
CARIBE ADVANCE 46	40-50	61/66	110-129	66-78	47-51	55-70	104-114	90	40-45	89°-114°	0°-30°	150	41
CARIBE ADVANCE 50	40-50	65/67	110-129	66-78	47-51	55-70	104-114	90	40-45	89°-114°	0°-30°	150	41

AZTECA

Pag 27

INCA

Pag 28

INCA PLUS

Pag 28

pag 27-31

VICKING

Pag 29

VICKING ADVANCE

Pag 30

VICKING SUSPENSION

Pag 31



AZTECA is plain and robust, comfortable and stable. The control commands integrate the most modern technology, with attractive and ergonomic design. The motors enable an easy and smooth drive. The tension regulating straps at the back provide additional comfort. Removable armrests and height adjustable and removable footrests. The batteries boxes are removable for ease of transport. With anti-tippers. Very compact dimensions for easy manoeuvrability. See accessories and options.



51 CD EL 2 AZ 40 AP
AZTECA (40)

AZTECA

Colour - structure	white
Colour - upholstery	black
Available sizes	40/43/46cm
Front wheels - pneumatic	Ø200mm
Back wheels - pneumatic	Ø300mm
Rear rims	nylon
Maintenance free AGM batteries	12V 42AH
Batteries charger	24V 5A
Motor	180W/200W
Autonomy	25km*
Maximum speed forward	6km/h*
Maximum speed reverse	3km/h*

TECHNICAL CHARACTERISTICS



Anti-tipping wheels



Tension adjustable backrest



Memory foam seat



Adjustable footrests



Joystick

MEASUREMENTS

in cm/kg- tolerance +/-1

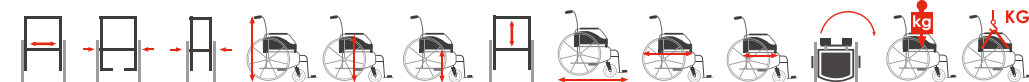

AZTECA 40	40	59	38	92	72	52	41	106	84	42	92	125	67
AZTECA 43	43	61	41	92	72	52	41	106	84	42	92	125	67
AZTECA 46	46	64	44	92	72	52	41	106	84	42	92	125	67

INCA



51 CD EL IN 49 AP
INCA 49

The new electric chair INCA offers an attractive design and state-of-the-art technology. Extremely compact and lightweight. Seat cushion and back lined with breathable 3D fabric. Lower support for placement of belongings. Motors and batteries built into the leg structure. Lithium batteries (24V/10Ah) are characterized by lightness and durability. It is suitable for use in doors and narrow sidewalks. Fully foldable for easy transport and storage, it is possible to move it with just one hand.

INCA

Colour - structure	grey
Colour - upholstery	black
Front wheels - pneumatic	Ø175mm
Back wheels - pneumatic	Ø200mm
Lithium batteries	10AH
Motor	180W
Autonomy	15km*
Maximum speed forward	6km/h*
Maximum reverse speed	3km/h*

MEASUREMENTS

in cm/kg- tolerance +/-1

INCA	66	38	86	51	41	100	42	12°	115	115	26,6
------	----	----	----	----	----	-----	----	-----	-----	-----	------



INCA PLUS



51 CD EL IP 43 AP
INCA PLUS Litium Suspension

The new electric chair INCA PLUS offers an attractive design. Extremely compact and lightweight. Seat cushion and back lined with breathable 3D fabric. Lower support for placement of belongings. Motors and batteries built into the leg structure. Lithium batteries (24V/10Ah) are characterized by lightness and durability. It is suitable for use in doors and narrow sidewalks. Fully foldable for easy transport and storage, it is possible to move it with just one hand. 300mm back wheels and front ones 175mm with suspension. Includes anti tipping wheels.

INCA PLUS

Colour - structure	grey
Colour - upholstery	black
Front wheels - pneumatic	Ø175mm
Back wheels - pneumatic	Ø300mm
Lithium batteries	12AH
Motor	250W
Autonomy	15km*
Maximum speed forward	6km/h*
Maximum reverse speed	3km/h*

MEASUREMENTS

in cm/kg- tolerance +/-1

INCA PLUS	62	48	94	52	49	110	42	12°	96	150	29,6
-----------	----	----	----	----	----	-----	----	-----	----	-----	------



Vicking, powered wheelchair made of steel, with 2 engines of 180/200W low consumption and electromagnetic brakes. Ensures the right positioning and security of the user with tension backstraps and 3D cover flexible backrest. Rigid seat, adjustable in width (50mm) through the armrest and in depth (400mm to 500mm continuously), with Comfort Seat cushion. Equipped with solid rear wheels Ø300mm and solid front wheels Ø200mm. Height and depth adjustable T shape armrests, with swing-away joystick. Footrests with bilateral opening and depth adjustment. Anti-tipping wheels. Options: manual, pneumatic or electric tilt and backrest recline.



51 CD EL VK 40
VICKING 40

VICKING

Colour - structure	white, grey
Colour - upholstery	black
Available sizes	40/43/46/50cm
Front wheels	Ø200mm
Back wheels	Ø300mm
Rear rims	nylon
Maintenance free AGM batteries	12V 42AH
Batteries charger	24V 5A
Motor	200W/24V
Autonomy	25km*
Maximum speed forward	6km/h*
Maximum reverse speed	3km/h*
Maximum recline	130° (mechanic)/120° (pneumatic/electric)
Tilt	0° - 30°/-5° - 25° (mechanic/(pneumatic/electric))

TECHNICAL CHARACTERISTICS



Joystick



Motor



Anti tipping wheels



Depth adjustable rigid seat



Tensioning backstraps



Adjustable T shape armrests

MEASUREMENTS

in cm/kg - tolerance +/-1

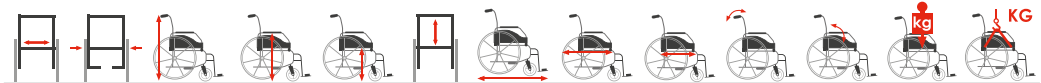

	40	43	46	50	66-80	47-51	55-70	102-107	76-81	40-45	90°-130°	0°-30°	150	77,5
VICKING 40	40	62	107-122	66-80	47-51	55-70	102-107	76-81	40-45	90°-130°	0°-30°	150	77,5	
VICKING 43	43	62	107-122	66-80	47-51	55-70	102-107	76-81	40-45	90°-130°	0°-30°	150	78,0	
VICKING 46	46	62	107-122	66-80	47-51	55-70	102-107	76-81	40-45	90°-130°	0°-30°	150	78,5	
VICKING 50	50	62	107-122	66-80	47-51	55-70	102-107	76-81	40-45	90°-130°	0°-30°	150	79,0	

VICKING ADVANCE



51 CD EL VK 40 50

VICKING ADVANCE M Tilt Electr; MODULAR seating

Vicking ADVANCE, electric wheelchair made of steel, with 2 engines of 180/200W low consumption and electromagnetic brakes. Ensures the right positioning and security of the user with tension back straps and 3D cover flexible backrest. Seating system fully modular with adjustable and separate plates allowing extensive adjustments in width, depth and height. Rigid seat, adjustable in width (400mm to 500mm continuously) and in depth (400mm to 500mm continuously), with Comfort Seat cushion. Equipped with solid rear wheels Ø300mm (option: Ø350mm and 300W engine) and pneumatic front wheels Ø200mm. Height and depth adjustable T shape armrests, with joystick. Footrests with bilateral opening and depth adjustment. Anti-tipping wheels. Height adjustable handles. Options: manual, pneumatic or electric tilt and pneumatic or electric recline.

See accessories and options.

VICKING ADVANCE

Colour - structure	white, grey
Colour - upholstery	black
Available sizes	40/43/46/50cm
Front wheels - pneumatic	Ø200mm
Back wheels - pneumatic	Ø300mm/Ø350mm
Rear rims	nylon
Maintenance free AGM batteries	12V 42AH
Batteries charger	24V 5A
Motor	200W/24V, 300W
Autonomy	25km*
Maximum speed forward	6km/h*
Maximum reverse speed	3km/h*
Maximum recline	130° (mechanic)/120° (pneumatic/electric)
Tilt	0° - 30°/-5° - 25° (mechanic/(pneumatic/electric))



Adjust. backrest with tensioning back straps



Adjustable rigid seat



Anti tipping wheels

MEASUREMENTS

in cm/kg- tolerance +/- 1

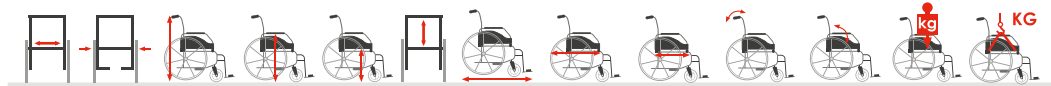

	40-50	62/64	107-122	66-80	47-51	55-70	102-107	76-81	40-45	90°-130°	0°-30°	150	78,0
VICKING ADVANCE 40	40-50	62/64	107-122	66-80	47-51	55-70	102-107	76-81	40-45	90°-130°	0°-30°	150	78,0
VICKING ADVANCE 43	40-50	62/64	107-122	66-80	47-51	55-70	102-107	76-81	40-45	90°-130°	0°-30°	150	78,5
VICKING ADVANCE 46	40-50	62/64	107-122	66-80	47-51	55-70	102-107	76-81	40-45	90°-130°	0°-30°	150	79,0
VICKING ADVANCE 50	40-50	62/64	107-122	66-80	47-51	55-70	102-107	76-81	40-45	90°-130°	0°-30°	150	79,5

VICKING SUSPENSION



51 CD EL VK SU 40 50

VICKING SUSPENSION M Tilt Electr; MODULAR seating

VICKING SUSPENSION

Colour - structure	white, grey
Colour - upholstery	black
Available sizes	40-50cm
Front wheels - pneumatic	Ø200mm
Back wheels - pneumatic	Ø350mm
Rear rims	nylon
Maintenance free AGM batteries	12V 50AH
Batteries charger	24V 5A
Motor	300W
Autonomy	25km*
Maximum speed forward	8km/h*
Maximum reverse speed	3km/h*
Maximum recline	90° - 130°/96° - 120°
Tilt	0° - 30°/-5° - 25°

VICKING SUSPENSION, powered wheelchair, fully adjustable, designed for outdoor use, with integrated suspension system. It guarantees the correct positioning and security of the user. With right hand control (standard), it can be placed on the left. With tensioning straps and 3D cover. Modular seat composed of rigid plates continuously adjustable in width (from 400 to 500mm) and in depth (from 400 to 500mm), with Comfort Seat 3D cushion. With mechanical recline and electric tilting (other options available). T-armrests adjustable in height and depth, detachable. Footrests with bilateral opening, height and depth adjustment. Pneumatic rear wheels 350mm and front 200mm. Anti-tipping wheels. Batteries AGM 12V 50Ah without maintenance. 300W motors. Maximum speed 8Km/h. Wide range of configuration options and accessories (see order form).

MEASUREMENTS

in cm/kg- tolerance +/-1



VICKING SUSPENSION 43

40-50

62/64

105

70-75

47-51

52

102-107

80

40-50

90°-130°

0°-30°

150

84

LIBERTY

Pag 33

ECO

Pag 33

COMPACT DELUXE

Pag 34

EXTRA

Pag 34

XXL

Pag 34

pag 33-34

LIBERTY

LIBERTY, the new mid-range scooter. It combines the flexibility of a detachable and practical scooter, easy for transport, with great benefits for outdoor use also on somewhat uneven floors. With swivel seat and folding armrests for easy access. Front basket in plastic. Delta shape handle anti-fatigue. 225mm wheels. With an electric motor of 250W, it reaches a top speed of 8 km/h. Autonomy for 17,5Km. Easily dismantlable in 4 parts, no tools required. Suitable for those who have some moving difficulties and / or suffer from fatigue, but still don't want to use the typical wheelchair. It promotes the autonomy of the user, for example, to go to the supermarket, to walk or visit friends.

LIBERTY

Maximum speed

8km/h

Capacity

135kg

Dimensions

112x60x87cm

Electric motor

200W

Lithium batteries

2x12V 22AH

Autonomy

17,5km*

Lightweight folding seat

46cm

Colour

blue, red



51 CD SC LI .03

Scooter LIBERTY - Elect which w/manual steering (Blue Grey)

ECO

ECO electric scooter with manual controls. With light and swivel seat with 46cm and folding armrest. 230mm wheels. Front basket. With an electric motor of 450W, it reaches a top speed of 8 km/h. Autonomy for approximately 20 km. Includes front light. Suitable for those who have some moving difficulties and / or suffer from fatigue, but still don't want to use the typical wheelchair. It promotes the autonomy of the user, for example, to go to the supermarket, to walk or visit friends.

ECO

Maximum speed

8km/h

Capacity

135kg

Dimensions

116x55x87cm

Electric motor

450W

Lithium batteries

2x12V 35AH

Autonomy

20km*

Lightweight folding seat

46cm

Colour

blue, red



51 CD SC EC .03

Scooter ECO Plus - Elect which w/manual steering (Blue Grey)

COMPACT DELUXE



51 CD SC CD .06
Scooter COMPACT DELUXE (Burgundy)

COMPACT DELUXE electric scooter with manual controls. With light and swivel luxury seat with 46cm and folding armrest. Delta shape handle anti-fatigue. 290mm wheels. Front basket . 700W motor, it reaches a top speed of 12 km/h. Autonomy for approximately 40 km. Includes front lights and mirror. Suitable for those who have some moving difficulties and / or suffer from fatigue, but still don't want to use the typical wheelchair.

COMPACT DELUXE

Maximum speed	8km/h
Capacity	160kg
Dimensions	134x62x100cm
Electric motor	500W
Lithium batteries	2x12V 45AH
Autonomy	40km*
Ajustable and reclining luxury seat	48cm
Colour	blue, red
Rear suspension coil over; Delta handle	

EXTRA



51 CD SC EX .06
Scooter EXTRA (Burgundy)

EXTRA electric scooter with manual controls. With light and swivel luxury seat with 46cm and folding armrest. Delta shape handle anti-fatigue. 320mm back wheels and 290mm front wheels. Front basket . 700W motor, it reaches a top speed of 12 km/h. Autonomy for approximately 40 km. Includes front lights and mirror. Suitable for those who have some moving difficulties and / or suffer from fatigue, but still don't want to use the typical wheelchair.

EXTRA

Maximum speed	12km/h
Capacity	180kg
Dimensions	139x67,5x102,4cm
Electric motor	700W
Lithium batteries	2x12V 45AH
Autonomy	40km*
Ajustable and reclining luxury seat	48cm
Colour	blue, red
Front and rear suspension; Anti-fatigue delta handle; Speed limiter and handbrake	

XXL



51 CD SC XXL .03
Scooter XXL (Blue grey)

XXL electric scooter with manual controls. With adjustable, reclining and swivel luxury seat with 46cm and folding armrest. 380mm wheels. Delta shape handle anti-fatigue. Front and back suspension . 800W motor, it reaches a top speed of 15 km/h. Autonomy for approximately 40 km. Includes lights and mirror. Suitable for those who have some moving difficulties and / or suffer from fatigue, but still don't want to use the typical wheelchair.

XXL

Maximum speed	15km/h
Capacity	226kg
Dimensions	163x76x103cm
Electric motor	800W 4300rpm
Lithium batteries	2x12V 80/100AH
Autonomy	50km*
Ajustable and reclining luxury seat	46cm
Colour	blue, red
Front and rear suspension; Delta handle	

MAIA

Pag 36

PLANE

Pag 36

AUXILIARY MOTOR

Pag 37

pag 36-37

MAIA



MAIA, wheelchair with innovative design, designed specifically for institutional use. Easy storage, without having to close the chair, for convenience and speed. With rigid steel frame, without detachable components and reinforced structure for users up to 180Kg. Folding armrests, with wide support surface for comfort. Seat with ergonomic inclination of 10°. Removable with a zipper, easily washable upholstery very resistant in net type. Polyester seat available in different colors. Ergonomic handles. Footrests metallic, with unique non-slip base. Rear wheels of 600mm (option: wheels 300mm). Solid 150mm front wheels, rotating 360°. Optional components: flag with institution ID, coin dispenser system, oxygen bottle holder, serum holder, seat belt and interchangeable upholstery. Recommended for use not only in hospitals and clinics, but also for use in shopping centers, airports and car parks.

MAIA

- Colour - structure
black
- Colour - upholstery
orange, green
- Front wheels - solid
Ø150mm
- Back wheels - pneumatic
Ø600mm/Ø300mm

51 CD IZ 2 NO L BX

MAIA Wheelchair

MEASUREMENTS

in cm/kg- tolerance +/-1

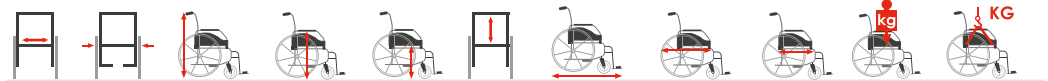

MAIA	43	68	105	72	53	45	105	84	46	180	13,9
MAIA AE	43	65	105	72	53	45	95	71	46	180	12,4

PLANE



Wheelchair for airplane cabin with steel structure epoxy coated metallic grey. Height adjustable headrest and foldable armrests. Upholstery with high density coating, washable and disinfected. Central brake and security seat belts. The top handles are foldable and the bottom are collapsible. With 4 solid Ø200mm wheels and 2 small castors. Maximum user's weight up to 180kg.

PLANE

- Colour - structure
grey
- Colour - upholstery
black
- Front wheels
Ø200mm
- Back wheels
Ø200mm

51 CD CA 2 DD

Plane cabin wheelchair grey wheels 200x30

MEASUREMENTS

in cm/kg- tolerance +/-1

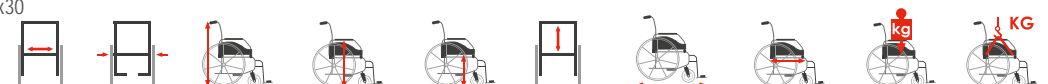

AVIÓN	31	43	94	69	43	45	80	35	180	20
-------	----	----	----	----	----	----	----	----	-----	----



51 MT AU
Auxiliary motor

AUXILIARY MOTOR

Colour - structure	grey
Colour - upholstery	black
Front wheels - solid	Ø150mm
Back wheels - pneumatic	Ø560mm
Maximum user weight	100kg
Total weight	15kg

PowerStroll kit is a motorized system designed to incorporate in manual wheelchairs and transform them into power chairs. With Powerstroll, the assistant makes no effort to push the wheelchair.

The engine is placed in the back of the chair and has a control command to place on the handle of the wheelchair to operate the engine. Allows to change the direction (forward and reverse) by a button on the battery holder and the speed control via a rotary knob on the remote. It has a battery level indicator so you know when to charge the batteries and power never fails to go beyond.

Easy installation, compatible with a wide variety of wheelchairs with rear wheels 300 mm and 600 mm. With a convenient transport bag.

Available in two models:

Auxiliar Motor - 150W

Auxiliar Motor Plus - 200W



Transport bag



Control command



PowerStroll



Battery level indicator

INTERIOR WHEELCHAIRS

COMMODE

Pag 39

COMFORT LIGHT

Pag 39

ANDALUS FIX

Pag 40

ANDALUS FOLDABLE

Pag 40

ANDALUS RECLINE

Pag 41

COMFORT PLUS

Pag 42

pag 39-42

COMMODE

COMMODE COMPACT, indoor chair with sanitary seat with lid. Padded PVC seat. Structure adjustable in height in 7 positions. With fixed arms. Specially designed to provide a comfortable seat and simultaneously assist people with reduced mobility in meeting the physiological needs, avoiding trips to the bathroom, especially at night.



51 CD IN 4 CO FX
COMMODE Fixed

COMMODE

Colour - structure

blue

Colour - upholstery

blue PVC

MEASUREMENTS

in cm/kg- tolerance +/-1

COMMODE	56	83-94,5	41	52	42,5	44	100	8
---------	----	---------	----	----	------	----	-----	---

COMFORT LIGHT

COMFORT LIGHT, indoor chair with fixed structure in champagne anodized aluminium. With anatomical sanitary seat, it guarantees the user an easy and practical way of having an indoor chair with an integrated WC functionality. The seat width 46cm standardizes almost all of the needs. Available without castors, with height adjustment; or model with castors, being 2 with brake, without adjustment in height. This chair allows to assist people with reduced mobility in the accomplishment of the physiological needs, avoiding to go to the bathroom, especially at night.



51 CD IN W AL 46 ZZ
Without castors

51 CD IN W AL 46 RR
COMFORTLIGHT Fixed champagne 4 46 150mm

COMFORT LIGHT

Colour - structure

anodized champagne

Seat

anatomic sanitary

Model

height adjustable without castors

Model

with 4 castors (2 with brake)

MEASUREMENTS

in cm/kg- tolerance +/-1

COMFORT LIGHT HEIGHT ADJUSTABLE	46	54	89/99	70/80	52-62	44	58	49	100	7
COMFORT LIGHT 4 CASTORS	46	54	93	74	56	44	59	49	100	7,8

ANDALUS FIX



ANDALUS FIX, with a steel structure and anatomic sanitary seat. ANDALUS joins 4 functions in one: the comfort of an interior chair that allows the sanitary use, directly or in the WC and maintains user's comfort. 46cm width thermomolding soft seat and detachable feet rest with side opening and height adjustable.

ANDALUS FIX

Colour - structure
grey
Weight without removable parts
8,8

51 CD IN 2 FE 46 RR FX

ANDALUS Fix 46-4 Castors

MEASUREMENTS

in cm/kg- tolerance +/-1

ANDALUS FIX

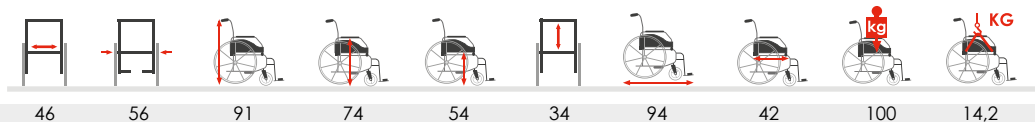

ANDALUS FOLDABLE



With a steel structure, anatomic seat and four Ø100mm castors, ANDALUS joins 4 functions in one: the comfort of an interior chair that allows the sanitary use, directly or in the WC and it is foldable to ease its transport. 46cm width thermomolding soft seat. Removable and height adjustable footrest. and detachable and height adjustable feet rest.

ANDALUS FOLDABLE

Colour - structure
grey
Weight without removable parts
9,4



51 CD IN 2 FE 46 RR

ANDALUS Foldable 46-4 Castors

MEASUREMENTS

in cm/kg- tolerance +/-1

ANDALUS FOLDABLE

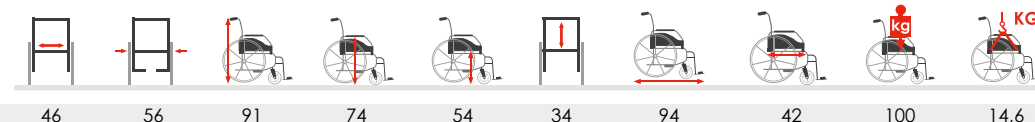

ANDALUS RECLINE

ANDALUS RECLINE, steel structure and 46cm width thermomolding soft seat. Padded rigid backrest viscoelastic foam sky cover, very comfortable and easy to clean. 120° mechanical recline. Height adjustable armrests. Side opening footrests. Ø100mm front wheels and rear casters. Also available model with Ø300mm back wheels.



51 CD IN 2 FE 46 RR AN
ANDALUS recline 46-4 castors

ANDALUS RECLINE

- Colour - structure
grey
- Castors 4
100mm
- Weight without removable parts
12,2kg

TECHNICAL CHARACTERISTICS



Armrests



Easy storage



Recline 120°



Without recline

MEASUREMENTS

in cm/kg- tolerance +/-1

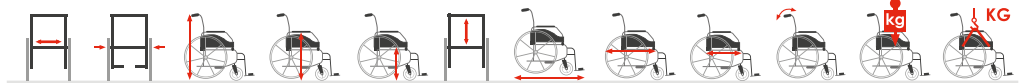

ANDALUS RECLINE 100mm	46	57	116-121	69-74	52	46	92	68	44	120°	100	19,6
ANDALUS RECLINE 300mm	46	63	116-121	69-74	52	46	92	68	44	120°	100	22,6

COMFORT PLUS



COMFORT PLUS, interior chair with steel frame and anatomical sanitary seat. It combines the advantages of a bed chair and a sanitary chair with possibility of direct use in the toilet. Provides high comfort, with anatomical sanitary seat, backrest viscoelastic foam sky cover and padded headrest adjustable in height and depth. It allows the recline backrest and the elevation of the footrests to the same level of the seat. Detachable armrests for easy transfers. With 600mm rear wheel with quick release and 125mm front wheels.



51 CD IN 2 CP 46 ED
COMFORT PLUS Recline 46

TECHNICAL CHARACTERISTICS



Adjustable armrests



Headrest



Elevating footrests



Bucket



Brake

COMFORT PLUS

Colour - structure	grey
Colour - upholstery	black
Front wheels - solid	Ø200mm
Back wheels - pneumatic	Ø600mm/Ø300mm
Castors 2	50mm
Rear rims	spokes
Weight without removable parts	9,4kg

MEASUREMENTS

in cm/kg- tolerance +/-1



COMFORT PLUS 46 300mm	46	63	116-145	61-71	52	46	109-141	82	44	120°	100	20
COMFORT PLUS 46 600mm	46	62	116-145	61-71	52	46	117-149	90	44	120°	100	18

ROBUSTNESS



MODULARITY



CUSTOMIZATION

**Orthos Mobility's
products last
a life time,
integrated solutions
and custom-made
manufacture...**

ORTHOS XXI
Rua de Santa Leocádia | 4809-012 Santa Leocádia de Briteiros
Guimarães | Portugal
Mobile +351 936 199 005
Phone: (+351) 253 470 637/276/270
E-mail: sofia.martins@orthosxxi.com
margarida.silva@orthosxxi.com
Fax: (+351) 253 470 278
info@orthosxxi.com

www.orthosxxi.com

ORTHOS
by **XXI**
e u r o p e a n
i n c l u s i v e s o l u t i o n s

ORT HOS

inclusive solutions

MOBILITY TECH

MOBILITY TECH

*Modularity
Configuration
Customization*





ORTHOS

XXI
e u r o p e a n
i n c l u s i v e s o l u t i o n s

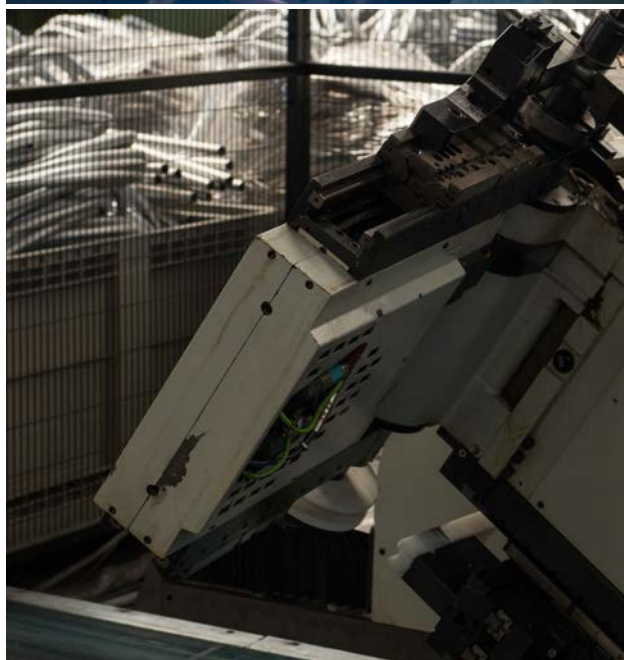

HISTORY

Orthos XXI originated from Conrado Dias Lda., a company founded in 1975 in Porto, Portugal.

In 1985, with great support from the owners Mr. Dias and Mrs. Marília, that the Mr. Ribeiro and Mrs. Zilda, decide to give continuity to the business of production and commercialization of walking aids, with the name of Ortomaia, thus concretizing an old aspiration of the Sr. Ribeiro owning a business. This new company has the assiduous collaboration of Manuel and Luisa and with the timely help of their other children, thus naturally involving the whole family in the process. The bases that make up the current dynamic of Orthos XXI were launched, based on values of affection and proximity among all generations of collaborators.

Together with the production activity, the distribution of products from national and international companies of great importance in the Sector is included in its portfolio.

In 1989, a wheelchair production unit was acquired and integrated, giving rise to two independent and distinct production units, but with joint commercialization.

In 1996 it was necessary to expand, integrate and fully optimize the business, so it was built in Guimarães, a new warehouse with twice the area to accommodate all the aspects of the business. With a view to the expansion and evolution of the activity, in 2007 Several decisive steps are taken:

A process of professionalization of management begins by separating the shareholder structure from the management structure, thus formally creating Orthos XXI.

A production unit for Geriatric and Hospital beds was installed and the facilities for the double were expanded again.

Direct participation in the Spanish market began, creating a commercial structure, OrthosMaia XXI, in Spain.

They initiate and develop several commercial actions to expand and develop new markets and new businesses.

In 2012, a consolidation and product development department was created, which, together with the continuous improvement of the Organization, has allowed the product range to be substantially expanded.

In 2017/18 Orthos XXI, reformulates its marketing and commercial strategy, organizing its product portfolio in ten brands.

We have a base with a productive DNA that allows us to continue production in Europe and a brand-oriented trade strategy to be able to face the competition of multinationals and Asian importers.

QUALITY

The quality of the ORTHOS XXI products can be confirmed in the best hospitals and institutions, where they have chosen us. Most of our products are class I medical devices and bear the CE mark, according to the Medical devices Regulation 2017/745 and are registered in the competent Authority, Informed and in the Eudamed. They are tested by accredited and independent entities, such as the IBV (Institute of Biomechanics of Valencia, in Spain). The company is also certified according to the EN ISO 9001 standard.

The value and qualification of human resources through the implementation of activity is training and updating in different areas have been strong bets of our company. ORTHOS XXI's main concern is the continuous improvement of production processes and services, as well as the improvement of the quality of its products, which allows us to better meet the needs and requirements of customers and users.

VALUES

We are driven by the conviction that, with our work, we contribute daily to improve the quality of life and to satisfy the needs of the users of our products and services. We prioritize an attitude of teamwork, flexibility and continuous improvement. We consider fundamental a constant investment in innovation and development of the products, currently counting on a team dedicated exclusively to this purpose.

These values support the presentation, in this new catalog, of some of the most recently developed novelties and, at the same time, to respond to the personalized needs of the users.



LIGHT WHEELCHAIRS

Latina Advance

06-07

ACTIVE SUPER LIGHT WHEELCHAIRS

Activa Invictus, Ativa Sioux

09-12

RELAX AND POSITIONING WHEELCHAIRS

Caribe, Caribe Advance

14-17

POWER WHEELCHAIRS

Vicking, Vicking Advance, Vicking Suspension, Vicking XL

19-27



LATINA ADVANCE

06



LATINA ADVANCE



LATINA ADVANCE, high-strength aluminum wheelchair. Triple cross bar provides the necessary strength and safety in a folding aluminum chair. Folding backrest (broken) in order to reduce the overall size of the chair when is folded for easy transport and storage. Depth adjustable seat. Height adjustable backrest, with lumbar tension straps for greater comfort. Armrest's height

and depth adjustable. Bilateral footrests (folding in and out), height adjustable and detachable. Spoked wheels with 600mm pneumatic or solid rear wheels with quick release. Option: 300mm rear wheels (transit). 200mm solid front wheels. Possibility of changing the wheel placement axels to allow seat angle and / or to change the seat height to the floor.

Features



Adjustable depth

Back Upholstery
accompanies depth
adjustment



Tension strips

Backrest with 2 tensioning
straps for added comfort



Folding backrest

Enables more compact
dimensions when closed



Adjustable armrests

Height and depth
adjustment



Bilateral footrests

With opening in and out,
adjustable in height and
detachable

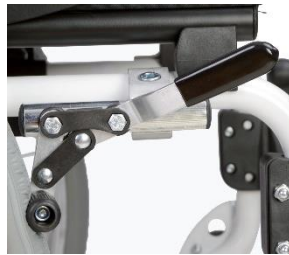

Parking breaks

Metal breaks



Wheel position

Several fulcrums for fixing
the rear wheel



Easy storage

Folding back and frame.
wheels with quick release

Technical data

Tolerance: +/-1cm

LATINA ADVANCE			
<i>Manufacturer: Orthos XXI Reference: CD LD 2 NO 37/40/43/46/50 ED</i>			
Seat width	370,400,430, 460,500mm	Chair height	920mm
Seat depth	400-500mm	Rear wheels	600mm
Seat height	510mm	Front wheels	200mm
Backrest height	410-435mm	Structure colour	White or grey
Chair width	570-700mm	Upholstery colour	Black
Chair width closed	300mm	Total chair weight	16,2kg
Chair depth	1000mm	Weight without detachable components	9,2kg
Chair depth without footrest	820mm	Maximum user weight	125kg
Armrests height	680-760mm		

ACTIVE SUPER LIGHT WHEELCHAIRS

09-12

ACTIVA INVICTUS

09

ATIVA SIOUX

12



ACTIVA INVICTUS



ACTIVA INVICTUS, resistant and functional Ø25mm tubes and triple cross bar wheelchair made of aluminium. Sideguard (option: folding armrest). Height and tension adjustable upholstery, with memory foam and 3D cover. Height adjustable

independent footrests. Height and depth adjustments of the rear wheels. Pneumatic rear wheels with quick release allows easy storage and transport. Seat width: 400, 430, 460mm. Maximum user weight: 125Kg.

Features



Rear wheel depth and height adjustment



Sideguard



Footrests



Easy storage

Technical data

ACTIVA INVICTUS			
<i>Manufacturer: Orthos XXI Reference: 51 CD SA 2 NO 40 ED</i>			
Seat width	400, 430, 460mm	Reclining backrest	-
Seat depth	420mm	Tilt	-
Seat height (without upholstery)	500mm	Rear wheels	600mm
Backrest height	325-425mm	Front wheels	150mm
Chair width	590, 620, 650mm	Structure color	Red, blue, white, black
Chair width closed	305mm	Upholstery color	Black
Chair depth	870mm	Total chair weight	12,9Kg
Chair depth without footrest	855mm	Weight without detachable components	9,6Kg
Armrests height	-	Maximum user weight	125kg
Chair height	840mm		

Tolerance: +/-1cm

ATIVA SIOUX



ATIVA SIOUX, active and light aluminum wheelchair (weight without wheels: 7.2Kg). With rigid, resistant and functional structure. Adjustable in height and depth. Rigid seat and back. Memory Foam back cushion and seat for extra comfort. Foldable backrest, adjustable in angle. Adjustable seat height,

depth and inclination. Unique footrests height-adjustable. Side panels. 600mm pneumatic rear wheels with spoke rims and quick release, solid 100mm front wheels. Compact brake system so as not to interfere with transfers. Seat width: 370, 400, 430, 460, 500mm. Maximum user weight: 125Kg.

Features



Adjustable to the user



Folding backrest



Ergonomic



Easy storage

Technical data

ATIVA SIOUX

Manufacturer: **Orthos XXI** | Reference: 51 CD SI 2 NO 37/40/43/46/50 ED

Seat width	370, 400, 430, 460, 500mm	Reclining backrest	85.5°, 88°, 90.5°, 96°, 98°, 101°
Seat depth	400-450mm	Tilt	-
Seat height	450-520mm	Rear wheels	600mm
Backrest height	295-395mm	Front wheels	100mm
Chair width	460, 490, 520, 550, 590mm	Structure color	Blue, red, white, golden
Chair width closed	-	Upholstery color	Black
Chair depth	760mm	Total chair weight	10,8Kg
Chair depth without footrest	-	Weight without detachable components	7,2kg
Armrests height	-	Maximum user weight	125Kg
Chair height	730-880mm		

Tolerance: +/-1cm

RELAX AND POSITIONING WHEELCHAIRS

CARIBE

14

CARIBE ADVANCE

17



CARIBE



CARIBE is a wheelchair adjustable to the user's needs, providing various adjustments to the seat and backrest level. Indicated for users with reduced mobility who need good postural support and frequent changes of position in order to compensate for situations of respiratory, circulatory and articular difficulties. Steel positioning chair, with pneumatic tilt (0° to 30° or -5° to 25°) and recline (89° to 114° or 96° to 120°) (mechanical reclining and tilting option). Height-adjustable rigid backrest with Comfort Back Lateral PU cushion. Rigid seat adjustable in depth (from 400mm to 500mm)

and width (50mm through the armrests) with Comfort Seat PU cushion. Various options available for seat and backrest cushions. Height adjustable handles. "T" shape armrests, adjustable in height and width (50mm) with a wide arm pad. Elevating footrests with side opening, depth and height adjustments (50mm). With solid rear wheels of 300mm or 600mm in diameter and solid front wheels of 200mm. Adjustable and removable anti-tippers wheels. For more configuration options and accessories consult the order form.

Features



Positioning

Depth adjustable rigid seat



Configuration

Rigid backrest prepared for the application of various accessories



Comfort

Pneumatic reclining and tilt; headrest (optional)



Safety

With adjustable anti-tippers wheels

Technical Data

CARIBE

Manufacturer: **Orthos XXI** | Reference: 51 CD PO CR 40/43/46/50

Seat width	40, 43, 46, 50cm	Tilt	0° a 30°/ -5° a 25°
Seat depth	40-50cm	Pneumatic reclining	96° a 120°
Seat height to floor	47-51cm	Rear wheels	300 or 600mm
Backrest height	52cm	Front wheels	200mm
Handles height	110-129cm	Structure color	White or grey
Armrests height to the floor	66-78cm	Upholstery color	Black
Total chair depth	104-114cm	Total chair weight	40,5Kg
Total chair width (300mm wheel)	68cm	Maximum user weight	150Kg
Total chair width (600mm wheel)	74cm		

Tolerance: +/-1cm

CARIBE ADVANCE



CARIBE ADVANCE is an positioning wheelchair in steel adjustable to the user's needs, providing various adjustments to the level of the seat and back. Indicated for users with reduced mobility who need good postural support and changes in position in order to compensate for situations of respiratory, circulatory and joint difficulties. With tilting (0° to 30° or -5° to 25°) and pneumatic reclining (89° to 114° or 96° to 120°) (mechanical reclining and tilting option). Fully modular seating system with rigid plates adjustable in width and depth. Height-adjustable rigid backrest, with two tension straps for the lumbar area, with lateral back comfort cushion. Rigid seat adjustable in depth (from 400mm to 500mm),

width (400mm to 500mm), height (520mm to 560mm) and angle (0° to 30° or -5° to 25°) with Comfort Seat cushion. Several options available for seat and back cushions. Height adjustable handles. With solid 300mm rear wheels (other options available) and solid 200mm front wheels. Parking and attendant brakes. "T" shape armrests, adjustable in height and depth with comfort cushion. Elevating footrests with side opening and depth adjustment (50mm). Adjustable and removable anti-tipper wheels. With 4-point transport kit. U-shaped headrest adjustable in height, depth and angle. For more configuration options and accessories, see order form.

Features



Positioning

Rigid seat base allows for various types of cushions



Customization

Various component and accessory options



Reclining and tilt

For frequent changes of position



Attendant Brake

Allows better control of the chair by the caregiver

Technical Data

CARIBE ADVANCE

Manufacturer: **Orthos XXI** | Reference: 51 CD PO CR 40 50

Seat width	400-500mm	Reclining backrest	96° until 120°
Seat depth	400-500mm	Tilt	0° until 30° or -5° until 25°
Seat height	470-510mm	Rear wheels	300, 600mm
Backrest height	550-700mm	Front wheels	200mm
Chair width	580-660mm	Structure colour	White, grey
Chair width close	-	Upholstery colour	Black
Chair depth	1040-1140mm	Total chair weight	40kg
Chair depth without Footrests	950mm	Weight without removable components	32kg
Armrest height	660-780mm	Maximum user weight	150kg
Chair height	1100-1290mm		

Standard equipment measurements | Tolerance: +/-1cm

19-27

VICKING

19

VICKING ADVANCE

21

VICKING SUSPENSION

23

VICKING XL

25



VIKING



VICKING, electric wheelchair designed for indoor and outdoor use. With robust steel structure. It guarantees the correct positioning and security of the user. With right hand control (standard), it can be placed on the left. Back with tensioning straps with cushion 3D cover. Rigid seat adjustable in width 5cm (through the armrests) and in depth (continuous from 40 to 50cm), with Comfort Seat 3D cushion. With mechanical recline and tilt (other options available).

Detachable armrest T-shape, height and with adjustable. Footrests with bilateral opening, height and depth adjustment. Pneumatic rear and front wheels. Anti-tip wheels. Batteries AGM 12V 50Ah without maintenance. 200W motors. Autonomy 25Km. Maximum speed 6Km/h, under normal floor conditions and user weight. Various configuration options and accessories (see order form). Also available in Mini and XL size.

Features



Rigid seat

Adjustable in depth from 40 to 50cm



3D Backrest

With integrated tensioning straps



Comfort

Various recline and tilt options



Security

Robust structure with anti-tip wheels

Technical data

VIKING

Manufacturer: **Orthos XXI** | Reference: 51 CD EL VK 40/43/46/50

Rear wheels	300mm	Pneumatic reclining	96°-120°
Front wheels	200mm	Maximum forward speed	6Km/h*
Seat width	400,430,460,500mm	Max reverse speed	3Km/h*
Seat depth	400-500mm	Batteries	12V 50Ah
Seat height	470-510mm	Autonomy	25Km*
Height backrest	520mm	Color structure	White or grey
Overall width	620mm	Upholstery	Black
Total depth	1020-1070mm	Total weight	77,5Kg
Tilt	0°-30° or -5°-25°	Maximum user weight	150Kg
Mechanical reclining	90°-130°		

*under normal floor conditions and user weight | Tolerance: +/-1cm

VICKING ADVANCE



VICKING ADVANCE, electric wheelchair, fully adjustable, designed for indoor and outdoor use. With robust steel structure. It guarantees the correct positioning and security of the user. With right hand control (standard), it can be placed on the left. With tensioning straps with cushion 3D cover. Modular seat composed of rigid plates continuously adjustable in width (from 400 to 500mm) and in depth (from 400 to 500mm), with Comfort Seat 3D cushion. With mechanical recline

and electric tilt (other options available). Detachable armrest T-shape, height and depth adjustable. Footrests with bilateral opening, height and depth adjustment. Pneumatic rear and front wheels. Anti-tip wheels. Batteries AGM 12V 50Ah without maintenance. 200W motors. Autonomy 25Km. Maximum speed 6Km/h, under normal floor conditions and user weight. Various configuration options and accessories (see order form). Also available in Mini and XL size.

Features



Rigid seat

Adjustable in width and depth from 400 to 500mm



3D Backrest

With integrated tensioning straps



Bilateral footrests

Independent adjustment of height and depth (eg useful in dysmetria)



Comfort

Various recline and tilt options

Technical data

VICKING ADVANCE

Manufacturer: **Orthos XXI** | Reference: 51 CD EL VK 40 50

Rear wheels	300mm	Pneumatic reclining	96°-120°
Front wheels	200mm	Maximum forward speed	6Km/h*
Seat width	400-500mm	Max reverse speed	3Km/h*
Seat depth	400-500mm	Batteries	12V 50Ah
Seat height	470-510mm	Autonomy	25Km*
Height backrest	520mm	Color structure	White or grey
Overall width	620mm	Upholstery	Black
Total depth	1020-1070mm	Total weight	77,5Kg
Tilt	0°-30° or -5°-25°	Maximum user weight	150Kg
Mechanical reclining	90°-130°	Warranty	2 years

*under normal floor conditions and user weight | Tolerance: +/-1cm

VICKING SUSPENSION



VICKING SUSPENSION, power wheelchair, fully adjustable, designed for outdoor use, with integrated suspension system. Due to its compact dimensions, it can also be used indoors. Robust steel structure. It guarantees the correct positioning and security of the user. With right hand control (standard), it can be placed on the left. Back with tensioning straps with 3D cover. Modular seat composed of rigid plates continuously adjustable in width (from 400 to 500mm) and in depth (from 400 to 500mm), with Comfort

Seat 3D cushion. Mechanical recline and electric tilt (other options available). Armrest "T" shape adjustable in height and depth, detachable, with large pad. Footrests with bilateral opening, height and depth adjustment. Pneumatic rear wheels 350mm and front 200mm. Anti-tip wheels. Batteries AGM 12V 50Ah without maintenance. 300W motors. Autonomy 30Km. Maximum speed 8Km/h, under normal floor conditions and user weight. Various configuration options and accessories (see order form).

Features



Rigid seat

Adjustable in width and depth from 400 to 500mm



3D Backrest

With tension straps



Bilateral footrests

Independent adjustment of height and depth (useful in dysmetria)



Comfort

Rear suspension for added comfort, recline and tilt options

Technical data

VICKING SUSPENSION

Manufacturer: **Orthos XXI** | Reference: 51 CD EL VK SU 40 50

Seat width	400 to 500mm	Structure color	White, grey, black, red, blue
Seat depth	400 to 500mm	Upholstery color	Black
Seat height	470-510mm	Motor	300W
Backrest height	520mm	Batteries	12V 50Ah
Chair width	620mm	Autonomy	30km*
Chair width closed	n/a	Maximum forward speed	8Km/h*
Chair depth	1020-1070mm	Maximum backward speed	3Km/h*
Chair depth without footrest	800mm	Maximum slope	6,8° (12%)*
Armrests height	700-750mm	Max. height over obstacles	50mm
Chair height	1050mm	Rotation radius	820mm
Reclining backrest mechanical/pneumatic	90-130°/96-120°	Total chair weight	103kg
Tilt	0° to 30° -5° to 25°	Weight without detachable components	100,5kg
Rear wheels	350mm	Maximum user weight	150kg
Front wheels	200mm		

*under normal floor conditions and user weight | Tolerance: +/-1cm

VIKING XL



VIKING XL, power wheelchair, designed for indoor and outdoor use. With robust steel structure. Ensures the correct positioning and safety of the user. With command on the right (standard), it is possible to place it on the left. Back with tensioning straps covered with cushion cover 3D. Rigid seat adjustable in width by 50mm (through the armrests) and in depth from 400 to 500mm (continuously), with ComfortSeat 3D cushion. With mechanical reclining and tilt (option:

pneumatic or electric). Detachable "T" armrests, adjustable in height and width. Footrests with bilateral opening, height and depth adjustment. Pneumatic rear wheels. With anti-tippers. AGM 12V 50Ah batteries without maintenance. 200W motors. Autonomy 25Km. Maximum speed 6 km / h, under normal floor conditions and user weight. Various configuration options and accessories (see order form).

Features



Rigid seat

Adjustable depth from 400 to 500mm



3D backrest

With integrated tensioning straps



Comfort

Various reclining and tilting configurations available



Safety

Robust structure with anti-tippers wheels

Technical data

VIKING XL

Manufacturer: **Orthos XXI** | Reference: 51 CD EL VK 54/58











Rear wheels	300mm	Pneumatic reclining	96°-120°
Front wheels	200mm	Maximum forward speed	6Km/h
Seat width	540,580mm	Maximum reverse speed	3Km/h
Seat depth	400-500mm	Batteries	12V 50Ah
Seat height	470-510mm	Autonomy	25Km
Backrest height	520mm	Colour structure	White or gray
Overall width	720mm	Colour upholstery	Black
Total depth	1020-1070mm	Total weight	80Kg
Tipping	0°-30° or -5°-25°	Maximum user weight	180Kg
Mechanical reclining	90°-130°		

Tolerance: +/-1cm

Optional Accessories and Components

Model VIKING XL

For all available configurations and accessories, please check order form.

<input type="checkbox"/> U head support	<input type="checkbox"/> 100% adjustable headrest with flaps	<input type="checkbox"/> Pillow Comfort Back Lateral 3D	<input type="checkbox"/> Pillow Comfort Back Lombar 3D	<input type="checkbox"/> Pillow Comfort Back Shoulder 3D
				
<input type="checkbox"/> Rigid back	<input type="checkbox"/> Rigid backs extendable up to 750mm	<input type="checkbox"/> Comfort Back Extension 100mm	<input type="checkbox"/> Pneumatic tipping	<input type="checkbox"/> Pneumatic reclining
				
<input type="checkbox"/> Supports lifting feet	<input type="checkbox"/> Amputated support	<input type="checkbox"/> Swing-away trunk support	<input type="checkbox"/> Twin support	<input type="checkbox"/> Abductor
				
<input type="checkbox"/> Seat belt	<input type="checkbox"/> Acrylic tray	<input type="checkbox"/> Wooden tray	<input type="checkbox"/> Support of serum	<input type="checkbox"/> Oxygen bottle holder
				
<input type="checkbox"/> Trunk vest woman with zip	<input type="checkbox"/> Trunk vest man with zip	<input type="checkbox"/> Trunk vest woman	<input type="checkbox"/> Trunk vest man	<input type="checkbox"/> Shoulder harness
				
<input type="checkbox"/> 2-point pelvic belt	<input type="checkbox"/> Pelvic belt 4 points	<input type="checkbox"/> Standard pelvic harness	<input type="checkbox"/> Pelvic harness in "T"	<input type="checkbox"/> Pelvic harness in "V"
				

MODULARITY



CONFIGURATION



CUSTOMIZATION

*Orthos Mobility Tech
manufacturates not
only wheelchairs **but**
“**THE**” wheelchair... for
you, because of you!*

ORTHOS XXI, Unipessoal Lda.

Rua de Santa Leocádia I 4809-012 Santa Leocádia de Briteiros
Guimarães I Portugal

Phone: (+351) 936 199 005 | (+351) 253 470 637

E-mail: margarida.silva@orthosxxi.com

export@orthosxxi.com

Fax: (+351) 253 470 278

info@orthosxxi.com

www.orthosxxi.com

by

ORTHOS
xxi
e u r o p e a n
i n c l u s i v e s o l u t i o n s

ORT HOS

inclusive solutions
PAEDIATRICS

PEDIATRIA

Color
Growth
Configuration



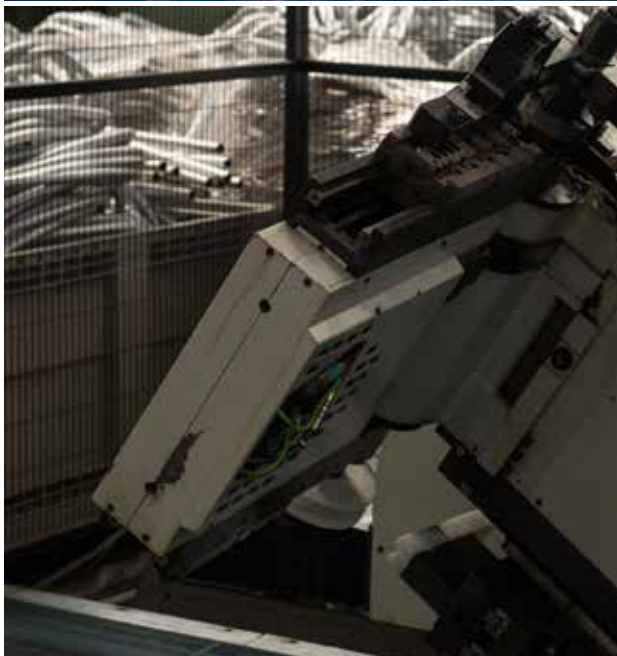

HISTORY

Orthos XXI originated from Conrado Dias Lda., a company founded in 1975 in Porto, Portugal.

In 1985, with great support from the owners Mr. Dias and Mrs. Marília, that the Mr. Ribeiro and Mrs. Zilda, decide to give continuity to the business of production and commercialization of walking aids, with the name of Ortomaiia, thus concretizing an old aspiration of the Sñr. Ribeiro owning a business. This new company has the assiduous collaboration of Manuel and Luisa and with the timely help of their other children, thus naturally involving the whole family in the process. The bases that make up the current dynamic of Orthos XXI were launched, based on values of affection and proximity among all generations of collaborators.

Together with the production activity, the distribution of products from national and international companies of great importance in the Sector is included in its portfolio.

In 1989, a wheelchair production unit was acquired and integrated, giving rise to two independent and distinct production units, but with joint commercialization.

In 1996 it was necessary to expand, integrate and fully optimize the business, so it was built in Guimarães, a new warehouse with twice the area to accommodate all the aspects of the business. With a view to the expansion and evolution of the activity, in 2007 Several decisive steps are taken:

A process of professionalization of management begins by separating the shareholder structure from the management structure, thus formally creating Orthos XXI.

A production unit for Geriatric and Hospital beds was installed and the facilities for the double were expanded again.

Direct participation in the Spanish market began, creating a commercial structure, OrthosMaia XXI, in Spain.

They initiate and develop several commercial actions to expand and develop new markets and new businesses.

In 2012, a consolidation and product development department was created, which, together with the continuous improvement of the Organization, has allowed the product range to be substantially expanded.

In 2017/18 Orthos XXI, reformulates its marketing and commercial strategy, organizing its product portfolio in ten brands.

We have a base with a productive DNA that allows us to continue production in Europe and a brand-oriented trade strategy to be able to face the competition of multinationals and Asian importers.

VALUES

We are driven by the conviction that, with our work, we contribute daily to improve the quality of life and to satisfy the needs of the users of our products and services. We prioritize an attitude of teamwork, flexibility and continuous improvement. We consider fundamental a constant investment in innovation and development of the products, currently counting on a team dedicated exclusively to this purpose.

These values support the presentation, in this new catalog, of some of the most recently developed novelties and, at the same time, to respond to the personalized needs of the users.

QUALITY

The quality of the ORTHOS XXI products can be confirmed in the best hospitals and institutions, where they have chosen us. Most of our products are class I medical devices and bear the CE mark, according to the Community Directives 93/42 / CEE and 2007/47 / CE and are registered in the competent Authority, Infarmed. They are tested by accredited and independent entities, such as the IBV (Institute of Biomechanics of Valencia, in Spain). The company is also certified according to the EN ISO 9001 standard.

The value and qualification of human resources through the implementation of activity is training and updating in different areas have been strong bets of our company. ORTHOS XXI's main concern is the continuous improvement of production processes and services, as well as the improvement of the quality of its products, which allows us to better meet the needs and requirements of customers and users.



MANUAL WHEELCHAIRS

Liliput - Liliput light - Accessories and Options

pag 6-7

ELECTRICAL WHEELCHAIRS

Vicking Advance Mini - Vicking Mini

pag 10-12

GROWING WHEELCHAIRS

Nemo

pag 14

POSITIONING WHEELCHAIRS

Caribe Mini - Caribe Advance Mini - Dory

pag 16-19

WALKING AIDS

Crutch - Walkers

pag 20

REHABILITATION WALKERS

Posterior Walker - Posterior Recovery Walker with Umbracal Support
Pelvic Walker and Trunk Stabilizer - Pelvic Walker - Pelvic and Axillary Walker

pag 22-23

REHABILITATION STANDERS

VERTICAL - Balu and Balu Posterior
SUPINE - Bat and Supine Stander
PRONE - Bob, Prone Stander and Prone Stander with Abduction
MULTIPOSITIONS - Flinstone , Ventral and Dorsal Inclined Stander

pag 25-28

ACTIVITY CHAIRS

Minnie - Tweety - Simba / Activity tables

pag 30-32

BATH CHAIRS

Baltic Mini - Melody

pag 34-35

BED

Hi-lo Mini Victory

pag 36



MANUAL WHEELCHAIRS

pag 6-7



LILIPUT

Pag 06

LILIPUT LIGHT

Pag 07

LILIPUT



LILIPUT, paediatric steel wheelchair, with modern and appealing design. Structure in blue and yellow and upholstery in red. With triple cross bar, removable armrest and height adjustable footrests, with folding pallet. Available with Ø550mm or Ø300mm (transit) rear wheels. See accessories.



53 CD 9 LI NO 31/34/37/ ED
LILIPUT 31/34/37 (550mm pneumatic spokes / solid 150mm)

TECHNICAL CHARACTERISTICS



Removable armrest



Triple crossbar



Folding



Removable footrest

LILIPUT LILIPUT TRANSIT

- Color - structure
yellow and blue
- Color - upholstery
red
- Available sizes
31/34/37cm
- Front wheels - solid
Ø150mm
- Solid / pneumatic rear wheels
Ø300mm/ Ø550mm
- Rear wheels
spokes / nylon
- Weight without removable components
11,3kg

MEASUREMENTS

in cm / kg - tolerance +/- 1

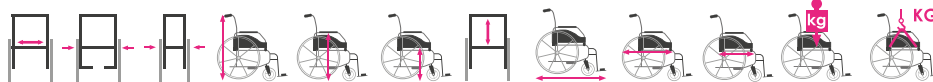

LILIPUT 31	31	52	33	90	67	49	40	95	73	34	125	12.8
LILIPUT 34	34	55	33	90	67	49	40	95	73	34	125	12.8
LILIPUT 37	37	58	33	90	67	49	40	95	73	37	125	12.8
LILIPUT TRANSIT 31	31	48	33	90	70	51	40	89	65	34	125	12.8
LILIPUT TRANSIT 34	34	51	33	90	70	51	40	89	65	34	125	12.8
LILIPUT TRANSIT 37	37	54	33	90	70	51	40	89	65	37	125	12.8

LILIPUT LIGHT, paediatric aluminum wheelchair ideal for active children, with modern and appealing design. White structure and upholstery in various options (pink, blue, pistachio or red). Removable armrest and height and lateral angle adjustable footrests, with folding footrest. Solid front wheels and Ø550mm rear wheels (pneumatic or solid). Also available with Ø300mm wheels (transit). See accessories.



Azul



53 CD 9 LI LT 31/34/37 EM
LILIPUT LIGHT 31/34/37 (150mm / 150mm solid spokes)

LILIPUT LIGHT LILIPUT LIGHT TRANSIT

Color - structure	white
Color - upholstery	blue, pistachio, red or pink
Available sizes	31/34/37cm
Front wheels - solid	Ø150mm
Solid / pneumatic rear wheels	Ø550mm/Ø300mm
Rear wheels	spokes
Weight without removable components	10kg

TECHNICAL CHARACTERISTICS



Pink



Pistachio

MEASUREMENTS

in cm / kg - tolerance +/- 1

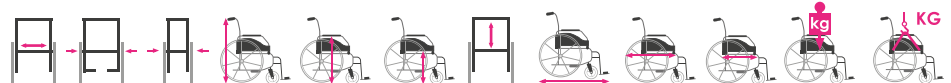

	31	34	37	Weight	Max Weight
LILIPUT LIGHT 31	31	51	26	91	74
LILIPUT LIGHT 34	34	54	26	91	74
LILIPUT LIGHT 37	37	57	26	91	74
LILIPUT LIGHT TRANSIT 31	31	48	26	91	74
LILIPUT LIGHT TRANSIT 34	34	51	26	91	74
LILIPUT LIGHT TRANSIT 37	37	54	26	91	74

ACCESSORIES AND OPTIONS

Headrest



Headrest



U-shaped headrest



100% adjustable headrest



Armrest reg. in height



Long armrest

Footrest



Footrest only



Elevating footrest

Backup and seat



Split backrest



Reclining backrest (pistons)



Reclining backrest (manual)



Backrest 3D reg voltage total



Backrest partial tension



Rigid backrest



Rigid seat



Comfort back cushion sop.in PU



Comfort back cushion sop. in 3D



Comfort back cushion sop. lumbar



Soft back pillow sop. lumbar



Comfort back cushion sop. shoulder



Comfort back extension 100mm



Comfort back extension 200mm



PU soft seat cushion 70mm



3D soft seat cushion 70mm



Cushion PU comfort seat 60mm



3D comfort seat cushion 60mm

Wheels



Anti-tipping wheels



Transfer kit



Motor hoop with 8 pins



Pneumatic front wheels



Solid front wheels



Pneumatic 300mm rear wheels



Pneumatic 300mm rear wheels



Pneumatic 550mm rear wheels

Others



Abductor



Acrylic board



Wood board



Security belt



Trunk support



Calf support

ELECTRICAL WHEELCHAIRS

pag 10-12

VICKING ADVANCE MINI

Pag 10

VICKING MINI

Pag 12

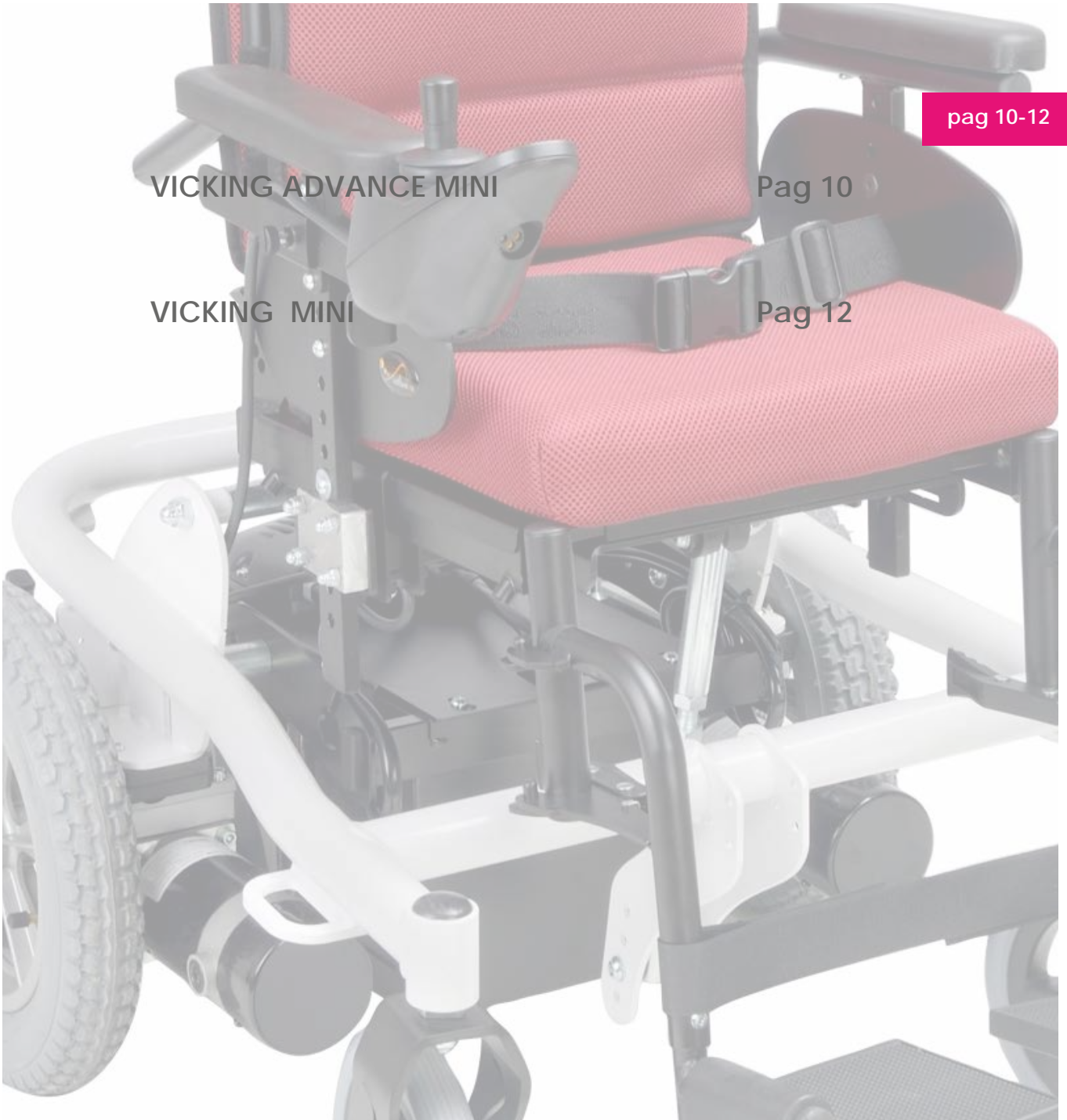

VICKING ADVANCE MINI



53 CD EL VK 30 40
VICKING ADVANCE MINI

TECHNICAL CHARACTERISTICS



Tension straps in the back



Maximum tilt and recline



Folding backrest



Adjustable armrests



Adjustable footrest

VICKING ADVANCE MINI

Max recline	90°-130°(mechanic) 96°-120°(pneumatic / electric)
Tipping	0°-30° (mechanic) -5° a 25° (pneumatic / electric)
Front wheels - pneumatic	Ø200mm
Rear wheels - pneumatic	Ø300mm
Color of the structure	white or gray
Maximum forward speed	6km/h*
Maximum speed back	3km/h*
Engine	200W
Maintenance-free AGM batteries	12V 50AH
Battery charger	24V, 5A
Autonomy	25km

(* under normal conditions of soil and user weight)



Anti-roll wheels



control

Vicking ADVANCE MINI, the electric wheelchair adjustable to growth. Made of steel, with 2 engines of 180/200W low consumption and electromagnetic brakes. With mechanic recline (91° to 132°) and electric tilt (0° to 30° or -5° to 25°). Ensures the right positioning and security of the child with height and width adjustable backrest, tension back straps and 3D Flexible Backrest cover. Rigid seat, adjustable in width (300mm to 400mm continuously) and in depth (300mm to 400mm continuously), with Comfort Seat cushion, 3D cover. Height and depth adjustable T shape detachable armrests, with joystick. Footrests with lateral opening and depth adjustment. Anti-tipping wheels. Height adjustable handles. Anti-tipping wheels. Also available with pneumatic or electric tilt and recline and adult sizes. For other configurations and accessories consult the order form. VICKING ADVANCE MINI, suitable for children with mobility problems that require a good postural support and that need frequent positioning change.



Adjustable backrest with tensioner straps



Adjustable rigid seat

VICKING ADVANCE MINI, suitable for children with mobility problems that require good postural support and frequent changes of position.

MEASUREMENTS

in cm / kg - tolerance +/- 1

VICKING ADVANCE MINI 31	30-40	62	93-105	70-75	47-51	45-52.5	123-128	90	30-35	90°-130°	0°-30°	150	77.5
VICKING ADVANCE MINI 34	30-40	62	93-105	70-75	47-51	45-52.5	123-128	90	30-35	90°-130°	0°-30°	150	77.5
VICKING ADVANCE MINI 37	30-40	62	93-105	70-75	47-51	45-52.5	123-128	90	35-40	90°-130°	0°-30°	150	77.5
VICKING ADVANCE MINI 40	30-40	62	93-105	70-75	47-51	45-52.5	123-128	90	35-40	90°-130°	0°-30°	150	77.5

GROWING WHEELCHAIRS



NEMO

Pag 14

pag 14

NEMO



53 CD 2 NE (19 25)/(25 31)/(31 37) ED

growth chair NEMO 25/28/31(R. hinch.550/150 mac)

NEMO

- Color - structure
pink, red, blue, white
- Color - upholstery
black
- Front wheels - solid
Ø150/Ø200mm
- Solid / pneumatic rear wheels
Ø550mm
- Rear wheels
with spokes
- Adjustable height and reclining backrest
15°
- Backrest position
85.5°/90.5°/96°/101°
- Footrest adjustment
-10° / 10°

NEMO, aluminum active paediatric growth wheelchair. Adjustable tension back and seat, with padded seat and backrest for maximum comfort. Seat height adjustable. Backrest height and angle adjustable. Height adjustable handles. Side panels. Unique footplate height, length and angle adjustable. 550mm pneumatic rear wheels and 100mm solid front wheels. Quick release rear wheels and foldable backrest for easy transport. See accessories.



MEASUREMENTS

in cm / kg - tolerance +/- 1



	1	2	3	4	5	6	7	8	9	10	11	12
NEMO 19 25	19-25	39-45	26	69.5	44-47	22-32	69	65	22-34	85.5°-101°	100	10.6
NEMO 25 31	25-31	45-51	26	74.5	44-47	22-32	69	65	22-34	85.5°-101°	100	10.6
NEMO 31 37	31-37	51-57	26	82	46-50	22-32	90.5	75	33-43	85.5°-101°	100	10.6

POSITIONING WHEELCHAIRS

CARIBE MINI

Pag 16

CARIBE ADVANCE MINI

Pag 18

DORY

Pag 19

pag 16-19



CARIBE MINI



CARIBE MINI, positioning wheelchair that provides maximum adaptability to user needs. Made of steel, with pneumatic recline (90°-130° or 89°-114°) and tilt (0° to 30° or -5° to 25°). Ensures correct positioning and child's safety. Height adjustable rigid back with Comfort Back lateral cushion. The seat is adjustable in width (50mm through the armrests) and depth (from 300mm to 400mm continuously), with Comfort Seat cushion 3D cover. Height adjustable handles. T shape armrests adjustable in height and width with Large cushion. Elevating footrests with side opening and depth adjustment (50mm). Adjustable and removable anti-tipping wheels. U shape headrest is adjustable in height and angle. For other configurations and accessories consult the order form.

53 CD PO CR 31/34/37/40

CARIBE MINI 31/34/37/40

TECHNICAL CHARACTERISTICS



Headrest



Rigid seat



Rigid backrest



Adjustable armrest



Elevating footrest

CARIBE MINI

Color - structure

white or gray

Manual / pneumatic recline

90°-130°/89°-114°

Tipping

0° to 35° or -5° to 25°

Front wheels - solid

Ø200mm

Solid rear wheels

Ø300mm

Available sizes

31/34/37/40cm

Seat depth adjustment

30-40cm

Weight without removable components

29,2kg

MEASUREMENTS

in cm / kg - tolerance +/- 1



	31	34	37	40	31	34	37	40	31	34	37	40	31	34	37	40	31	34	37	40	31	34	37	40
CARIBE MINI 31	31	58	106-120	70-80	47-51	45-52.5	106-116	98	30-35	90°-130°	0°-30°	125	37.5											
CARIBE MINI 34	34	58	106-120	70-80	47-51	45-52.5	106-116	98	30-35	90°-130°	0°-30°	125	37.5											
CARIBE MINI 37	37	58	106-120	70-80	47-51	45-52.5	106-116	98	35-40	90°-130°	0°-30°	125	37.5											
CARIBE MINI 40	40	58	106-120	70-80	47-51	45-52.5	106-116	98	35-40	90°-130°	0°-30°	125	37.5											



53 CD PO CR 30 40
CARIBE ADVANCE MINI (30-40)

CARIBE ADVANCE MINI

Color - structure	white or gray
Manual / pneumatic recline	90°-130°/89°-114°
Tilt	0° to 30° or -5° to 25°
Front wheels - solid	Ø200mm
Solid rear wheels	Ø300mm
Tires	nylon
Adjustable seat depth	30-40cm
Adjustable seat width	30-40cm
Weight without removable components	29,5kg

TECHNICAL CHARACTERISTICS



Headrest



Attendant brake



3D Comfort Back lateral



Comfort Seat in 3D



Elevating footrest

CARIBE ADVANCE MINI, positioning wheelchair that provides maximum adaptability to user needs. Made of steel, with pneumatic recline (90°-130° or 89°-114°) and tilt (0° to 30° or - 5° to 25°). Height adjustable rigid back plate with tension back straps with Comfort Back lateral cushion 3D cover. The seat is adjustable in width (from 300mm to 400mm continuously) and depth (from 300mm to 400mm continuously), with Comfort Seat cushion 3D cover. Several options available for seat and backrest cushions. Height adjustable handles and transport kit with 4 fixation points. Equipped with Ø300mm solid rear wheels and Ø200mm solid front wheels. Parking and attendant 's brakes. T shape armrests adjustable in height and depth with Comfort cushion. Elevating footrests with side opening and depth adjustment (50mm). Adjustable and removable anti-tipping wheels. U shape headrest is adjustable in height, angle and depth. Wide range of accessories available. For other configurations and accessories consult the order form. CARIBE ADVANCE MINI is an adjustable wheelchair to user needs, providing numerous points of attachment to the seat and backrest.



Rigid backrest with tensioner strips



Adjustable rigid seat

CARIBE ADVANCE MINI is a chair that adjusts itself to the needs of the user, providing unrestricted fixing points at the seat and backrest level.

MEASUREMENTS

in cm / kg - tolerance +/- 1

CARIBE ADVANCE MINI 31	30-40	58	93-120	70-80	47-51	45-52.5	106-116	98	30-35	89°-114°	0°-30°	150	37.5
CARIBE ADVANCE MINI 34	30-40	58	93-120	70-80	47-51	45-52.5	106-116	98	30-35	89°-114°	0°-30°	150	37.5
CARIBE ADVANCE MINI 37	30-40	58	93-120	70-80	47-51	45-52.5	106-116	98	35-40	89°-114°	0°-30°	150	37.5
CARIBE ADVANCE MINI 40	30-40	58	93-120	70-80	47-51	45-52.5	106-116	98	35-40	89°-114°	0°-30°	150	37.5



53 CD DO 31 37 ED
DORY 31/34/37 (600 Solid/ 150 solid)

DORY | DORY FIXED

Color - structure	black, blue, red
Manual / pneumatic recline	90°-130°/89°-114°
Tipping	0° to 50° or -5° to 45°
Front wheels	Ø150mm
Solid / pneumatic rear wheels	Ø300mm
Available sizes	25-31/31-37/37-40cm

DORY, pediatric growth chair, designed for children in need of positioning but also in caregivers who need a lightweight and practical chair to transport on a day-to-day basis. In aluminum, with tilting (tilt), combines the ability of positioning with easy transport. Highlight for the tilting function that helps in pressure control and maintaining the proper posture. Back and seat with rigid base, easily removable (without using keys), adjustable in width (+ 3cm through the plates + 5cm through the armrests). As standard, it includes adjustable headrest "U" shape, ComfortBack Lateral backrest cushion and ComfortSeat seat cushion, however, other types of systems can be applied. Detachable T shape armrests, height, width and depth adjustable. Height adjustable, foldable and detachable legrests. 300mm pneumatic rear wheels with quick version and 150mm solid front wheels. Adjustable and removable anti-tipping wheels. Available in 2 versions: foldable DORY (with cross bar to allow the chair to close) and fixed DORY (rigid frame). Consult the order form for other configurations and accessories.



MEASUREMENTS

in cm / kg - tolerance +/- 1

DORY 25-31	25-31	45-51	100-107,5	62-68	43.5-48	50.5	93	85	30-35	8°	4	82.5°-105°	75	18-25			
DORY 31-37	31-37	51-57	100-107,5	62-68	43.5-48	50.5	93	85	35-45	8°	4	82.5°-105°	75	18-25			
DORY 37-40	37-40	57-60	100-107,5	62-68	43.5-48	50.5	93	85	40-50	8°	4	82.5°-105°	75	18-25			

WALKING AIDS

CRUTCH C4



Lightweight open cuff crutches with soft handle. Height adjustable. With 16mm ferrules.

JUNIOR CRUTCH C4

Color - structure 53 CN 4 AF PM JU
blue and yellow

Color - structure 53 CN 8 AF PM JU
orange and gray

Color - structure 53 CN 6 AF PM JU
red and yellow

Color - structure 53 CN X AF PM JU
natural aluminum



Soft handle



Regulation



Fixed joint



Ferrules 16mm

53 CN X AF PM JU

Junior Aluminum Crutch

MEASUREMENTS

in cm / kg - tolerance +/- 1



82-102



20



62-82

CRUTCH

WALKERS A7



Walker with wheels, with aluminium and steel structure. Foldable and height adjustable. With 20mm anti-skid rubber ferrules and 120mm front wheels. Anatomical grips. Its colourful design offers the user a pleasant to use aid.



Anatomic handles



Adjustable in height

53 AN 9 RD 03

Walker Wheels A7 - Multicolor / Junior

MEASUREMENTS

in cm / kg - tolerance +/- 1



74-84



56



41



3,2

WALKERS

REHABILITATION WALKERS

POSTERIOR WALKER,
POSTERIOR RECOVERY WA-
LKER (whit umbracal su-
pport)

Pag 22

PELVIC WALKER AND TRUNK
STABILIZER,
PELVIC WALKER,
PELVIC AND AXILLARY
WALKER

Pag 23

pag 22-23

POSTERIOR WALKER



59 AN 3 PT AB XS

Walker Rehabil. Posterior Artic. Antebrachial Support XS



59 AN 3 PT XS

Walker.Rehabil.Posterior Artic. Straight grips XS

MEASUREMENTS

in cm / kg - tolerance +/- 1

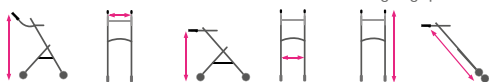

POSTERIOR WALKERS XXS	52-61	40	52-62	52	59	60
POSTERIOR WALKERS XS	55-65	45	62-72	57	66	62
POSTERIOR WALKERS S	65-78	55	72-82	67	78	73

Posterior walker with height adjustable front arc with straight handles. Reverse-roll locks at the rear wheels. Foldable. 3 sizes available

POSTERIOR WALKERS

Color - structure	blue / orange / yellow / gray / black
Color - upholstery	black
Solid wheels	Ø150mm
Maximum user weight	35/50/70kg



Vert. hand grip and forearm support

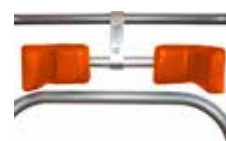

Comb. gluteal and pelvic support

POSTERIOR RECOVERY WALKER (WITH UMBRACAL SUPPORT)



59 AN 2 RC PT AU

Walker Rehabil Posterior c/Ap Umb

Posterior recovery walker with umbracal support in aluminum, height adjustable front arc and two sets of handles, one set to the child and the other to the handler to help. Suitable for children with difficulties of standing up. Brackets with security locks. Robust base, with 4 casters, all with brakes. Easy transport and storage.

Posterior recovery walker umbracal S

Color - structure	metalized ash and orange
Dimensions	50(L) x 81(P) x 103(a) 125(A)
Wheels	Ø100mm
Total weight	11kg
Maximum user weight	35kg

Posterior recovery walker umbracal M

Color - structure	metallic gray and orange
Dimensions	56(L) x 86(P) x 129(a) 154(A)
Wheels	Ø100mm
Total weight	13kg
Maximum user weight	50kg

PELVIC SUPPORT WALKER AND TRUNK STA.



Dynamic walker with pelvic support. Suitable for users with difficulties of standing up.

59 AN 2 RD SP ET

Pelvic support walker and trunk stabi.(0,8-1,2m)

WALKER WITH PELVIC SUPPORT AND TRUNK STABILIZER

Color - structure

yellow

Wheels

2+2T

PELVIC SUPPORT WALKER



Dynamic walker with pelvic support. Suitable for children with difficulties of standing up. Robust base, with 4 casters, all with brakes and foot tab (accessory).

59 AN 2 RD SP

Anterior walker with pelvic support S (0,8m-1,2m)

PELVIC SUPPORT WALKER S/M

Color - structure

Metallic gray

Wheels

Ø100mm

MEASUREMENTS

in cm / kg - tolerance +/- 1



	Height	Width	Depth	Weight
WALKER WITH SUPPORT PELVIC S	54-79	36	10	35
WALKER WITH SUPPORT PELVIC M	79-101	45	12	50
PELVIC SUPPORT AND TRUNK STABILIZER			9/9.5/10	30/35/40

PELVIC AND AXILLARY SUPPORT WALKER

Dynamic walker with arm support, hand grip and pelvic support (height adjustable and padded). Allows upright position and walking for people with low mobility (hemiplegia, cerebral palsy, postoperative, etc.). Brackets with security locks. Robust base, with 4 casters, all with brakes and foot tab (accessory). Appealing and modern design. Available in 3 sizes.

PELVIC AND AXILLARY SUPPORT WALKER/M

Color - structure

Metallic gray

Wheels

Ø100mm



Security locks



Tab (accessory)



Ergonomic handles



59 AN 2 RD SP SA S

Pelvic and axillary walker (1,1m-1,4m)

MEASUREMENTS

in cm / kg - tolerance +/- 1

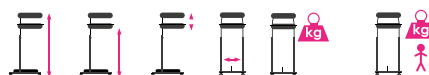

	Height	Width	Depth	Weight	Weight	
WALKER WITH SUPPORT PELVIC S	74-101	54-79	0-44	36	14	35
WALKER WITH SUPPORT PELVIC M	100-126	79-101	0-54	45	17	50

REHABILITATION STANDERS

VERTICAL

Pag 25

BALU AND BALU POSTERIOR

SUPINE

Pag 26

BAT, SUPINE STANDER

PRONE

Pag 27

BOB, PRONE STANDER, PRONE STANDER

WITH ABDUCTION

MULTIPOSITIONS

Pag 28

FLINTSTONE AND INCLINED STANDER

VENTRAL AND DORSAL

pag 25-28

BALU

This product offers a simple and easy way to enjoy a wide range of advantages that upright position promotes to the osteo-articular, metabolic, circulatory, labyrinthic systems and all the surrounding that characterizes the human being. Knee support adjustable in height, width and depth. Trunk and pelvic support height adjustable, available in 3 colors: pink, blue and yellow. Sandals width and depth adjustable. Casters with brake (option). Available in 3 sizes. Tray height adjustable (optional).

STANDING FRAME BALU

Color - upholstery
pink, blue, yellow



59 ST 0 TB (XXS/XS/S)

BALU-STANDER Vertic C/Band

MEASUREMENTS

in cm / kg - tolerance +/- 1



	50x55	65x75	71.5/101.5	33	35kg	10kg
Standing frame XXS	50x55	65x75	71.5/101.5	33	35kg	10kg
Standing frame XS	55x55	70x75	91.5/121.5	37,5	50kg	12.5kg
Standing frame S	60x60	76x80	111.5/141.5	42,5	75kg	15kg

BALU POSTERIOR

Static vertical positioner for paediatric use, with height adjustable trunk support (2 adjustable velcro bands), height and width adjustable hip support, height adjustable knee support and heels support. Available in 3 sizes depending on the child's weight and height.



59 ST 6 PT 01

Standing Frame Posterior

MEASUREMENTS

in cm / kg - tolerance +/- 1



	50x45	85	35kg	10kg
Standing frame posterior XXS	50x45	85	35kg	10kg
Standing frame posterior XS	55x50	100	45kg	12.5kg
Standing frame posterior S	60x55	115	55kg	15kg

BAT



BAT is an electric tilting stander that allows to go from the horizontal position to the vertical position through electric control, allowing to assume the supine position. With trunk and pelvis section adjustable in height and depth through central column, this stander allows several independent adjustments to the level of the knees and feet. With abduction function (optional) of each leg up to 40°, obtaining a total abduction of 80°, individually adjustable, with regulation of 5°. Headrest 100% adjustable. Tray (optional) adjustable in height and inclination. Double containment belts for safety. Possibility of placing various accessories. Possibility of changing to prone.

59 ST 0 SU EL S
BAT Elec. (S)-STANDER SUPINE Multip;

MEASUREMENTS

in cm / kg - tolerance +/- 1

			
Bat XS	58	0°-90°	50kg
Bat S	60	0°-90°	75kg

BAT XS

Base with wheels
103x58cm
User height
85-120cm

BAT S

Base with wheels
110x60cm
User height
120-150cm

SUPINE STANDER









Tilt table with casters, with 3 adjustable cushions and foot supports.

59 PI 6 PQ/MD

MEASUREMENTS

in cm / kg - tolerance +/- 1

							
Supine stander S	50	65	0°-90°	75-90	30	30kg	11kg
Supine stander M	55	75	0°-90°	90-105	32	40kg	12kg

BOB is an electric tilting stander that allows to go from the horizontal position to the vertical position through electric control, allowing to assume the prone position. With trunk and pelvis section adjustable in height and depth through the central column, this stander allows several independent adjustments at the level of the knee and foot supports. With abduction function (optional), from 0° to 40° (totaling 80°), individually adjustable, with regulations of 5°. Headrest 100% adjustable. Double containment belts for safety. Tray (optional) adjustable in height and inclination. Possibility of placing various accessories. Possibility of changing to supine.



BOB XS

Base with wheels
103x58cm
User height
85-120cm

BOB S

Base with wheels
110x60cm
User height
120-150cm

MEASUREMENTS

in cm / kg - tolerance +/- 1

Bob XS	58	0°-90°	50kg
Bob S	60	0°-90°	75kg

59 ST 0 PR EL (XS/S)

BOB Elec.(XS)-STANDER PRONE Ajust;

PRONE STANDER



59 PI 6 TB PQ/MD
PRONE STANDER-Ref 33-SMALL

Tilt table with casters, with 3 adjustable cushions and foot supports. adjustable padded bodies and supports for the feet. With tray.

PRONE STANDER WITH ABDUCTION



59 PI 6 TB AB PQ/MD
Variable angle positioner - Ref 40 SMALL

Tilt table with casters, with upper body padded support, abduction piece with back and individual feet support, all components height adjustable. With tray.

MEDIDAS

en cm/kg - tolerancia +/- 1

Prone stander S	50	65	0°-90°	75-90	30	30kg	11kg
Prone stander M	55	75	0°-90°	90-105	32	40kg	12kg
With abduction S	55	80	0°-90°	75-90	30	30kg	15kg
With abduction M	60	85	0°-90°	90-110	30	40kg	16.5kg

FLINTSTONE



Electric tilting table that allows to go from the horizontal position to the vertical position through electric control, allowing to assume the supine position. With 2 adjustable padded and adjustable cushions in viscoelastic foam. Footrest height and depth adjustable, prepared for sandals application. Fabric in several colors (option). Has the advantage of having a battery, so can be used in any space. Wide range of accessories available.

FLINTSTONE S

Base	110 x 63cm
Width	63cm
Vertical height	159 - 189cm (+20cm)
Horizontal height	60 / 65 / 70cm
Pad	150 x 60cm
Pad (thickness)	6cm
Reclining	0°-90°
Maximum user weight	125kg

FLINTSTONE M

Base	151 x 63cm
Width	63cm
Vertical height	208 - 218cm (+20cm)
Horizontal height	81 / 86 / 91cm
Pad	190 x 70cm
Pad (thickness)	7cm
Reclining	0°-90°
Maximum user weight	125kg



59 PI 3 SU EL
FLINTSTONE ELEC. (M) - Stander INCLIN SUPINE

VENTRAL AND DORSAL INCLINED STANDER



Ventral and dorsal tilt table with 4 casters (two with brakes) with multiple tilt positions. It consists of a height adjustable platform marquise and a smaller pad height adjustable. Height adjustable footrests, with two adjustable velcro bands to support the trunk and legs. Available models with or without tray.

PRONE AND SUPINE INCLINED STANDER XS

Long	36cm
Minimum height	90cm
Maximum height	100cm
Reclining	0°-90°

PRONE AND SUPINE INCLINED STANDER S

Long	41cm
Minimum height	105cm
Maximum height	115cm
Reclining	0°-90°

59 PI 6 DV PQ/MD
PRONE AND SUPINE INCLINED STANDER -Ref 35-PQ

ACTIVITY CHAIRS

MINNIE AND SIMBA

Pag 30

TWEETY

Pag 31

DORA, FIONA AND ALICE

Pag 32

pag 30-32



MINNIE



53 CD E AT MN 30
MINNIE 30

MEASUREMENTS

in cm / kg - tolerance +/- 1



MINNIE 26	26-38	26	24-28	95°-105°	38,5-43,5	0-17	50
MINNIE 30	26-38	30	28-32	95°-105°	40,5-45,5	0-17	50
MINNIE 34	26-38	34	32-36	95°-105°	43,5-48,5	0-17	50
MINNIE 38	26-38	38	36-40	95°-105°	45,5-50,5	0-17	50

MINNIE, birchwood chair for low/medium trunk support. The relatively low seat height enables the child's integration with other children seating at the same level. Birchwood and termo laminate chair with upholstery in pink, yellow or blue and interior in HD polyurethane and memory foam.

Functionalities:

- Seat recline
 - Height adjustable legs
 - Back reclination (95° - 105°)
 - Seat's depth adjustment (4cm)
 - Armrests adjustment in height and angle
- Available accessories: abductor, trunk lateral support, side pads.

MINNIE

Backrest height	42 cm
Adjustment of seat depth	4cm
Regulation of the arms rest in angle and height	
Color - structure	pink, green water, yellow

SIMBA



53 CD E AT SB
SIMBA Blüue

MEASUREMENTS

in cm / kg - tolerance +/- 1



SIMBA 28	45	30	28	28	95°- 115°	45°	25 - 35	40
SIMBA 32	60	34	32	32	95°- 115°	45°	30 - 35	40
SIMBA 34	70	40-45	34	34	95°- 115°	45°	35-40	40

Medium/high postural support. Boosted seat height to allow a better ergonomic of the caregiver in the activities. Multi-functional chair with high adaptation to the user.

SIMBA

Chair in wood to place the child	
Footrest adjustable in height	
Abductor	
Headrest (option)	

TWEETY, low or high postural support chair. The seat height enables the caregiver suitable ergonomics in the development of the activities. Multifunctional chair with high adaptation to the user. Chair in birch wood and termo laminate with yellow, pink or blue upholstery, interior in HD polyurethane and memoryfoam.

Included as standard:

- Adjustable footrests support
- 1 pelvic belt

* Accessories:

- headrest
- swing away lateral trunk support
- abductor
- casters
- sandals
- tray

TWEETY

High backrest	45cm
Low backrest	30cm
Elevating footrest and height adjustable	60°
Seat depth adjustment	-2;0:+2cm
Tilt of the seat	tilt and reverse tilt



53 CD E AT NM
TWEETY Yellow with Footrest 26

TECHNICAL CHARACTERISTICS



Adjustable head support in height, angle and depth



Adjustable armrest



Headrest with adjustable pads



Trunk support swing away



Tray in wood



Abductor



Back-angle adjustment



Backrest extension



Foot support



Legrests angle adjustable

MEASUREMENTS

in cm / kg - tolerance +/- 1

TWEETY 26	42 - 58	26	28 - 32	95° - 130°	0-17	90°-150°	20 - 40	50
TWEETY 30	42 - 58	30	32 - 36	95° - 130°	0-17	90°-150°	20 - 40	50
TWEETY 34	42 - 58	34	36 - 40	95° - 130°	0-17	90°-150°	20 - 40	70
TWEETY 38	42 - 58	38	40 - 44	95° - 130°	0-17	90°-150°	20 - 40	70

ACTIVITY TABLES - DORA AND FIONA



DORA HIGH - 56 ME E DO FX 56



DORA - 56 ME E DO FX 48

Model with fixed top and front protection. Small Dora and High Dora for better ergonomics of child and carer. FIONA - Model with angle adjustable top and storage area. Small Fiona and High Fiona for better ergonomics of child and carer.



FIONA HIGH - 56 ME E FI AR 56



FIONA - 56 ME E FI AR 48

MEASUREMENTS

in cm / kg - tolerance +/- 1



DORA	80	58	46 - 62	
DORA HIGH	80	58	56 - 73	
FIONA	80	58	46 - 62	0°- 60°
FIONA HIGH	80	58	56 - 73	0°- 60°

Model with angle adjustable top and storage area. Small Fiona and High Fiona for better ergonomics of child and carer.

ELECTRIC TABLES - ALICE



53 ME E AL GR

Modern model with height adjustable top. Possibility to combine various tops and bases. Also available control with memorised predefined heights (53 ME E AL GR).

ALICE

Board	118 x 80cm
Base	90x67cm
Height adjustment	69-113cm



BATH CHAIRS



BALTIC MINI

Pag 34

MELODY

Pag 35

pag 34-35



53 CD X ME 31/34/37
MELODY Bath Chair 31/34/37 with Shower Base

Bath chair for cerebral palsy with aluminum structure, waterproof and washable mesh, with adjustment of the backrest or legs in various positions. Available version with two or three bodies. Includes pelvic belt and adjustable headrest. Other accessories available. Also available shower and bathtub bases to lift the work area and improve the care taker's comfort.

SHOWER BASE

Melody 31	Melody 37
473x725x(500-625)mm	533x783x(500-625)mm
Melody 34	Melody 40
503x755x(500-625)mm	563x815x(500-625)mm

BASE BATH

Melody 31	Melody 37
473x725x380mm	473x725x380mm
Melody 34	Melody 40
473x725x380mm	473x725x380mm



Melody 3 Articulated Bodies

MEASUREMENTS

in cm / kg - tolerance +/- 1



MELODY 31	31	21.5	46.2	4°	37.8	82	75
MELODY 34	34	28.5	56.2	4°	40.8	100	75
MELODY 37	37	33.5	66.2	4°	43.8	118	75
MELODY 40	40	38.5	76.2	4°	46.8	136	75

BED - HI-LO MINI VICTORY



53 BE 3 MV EL

Bed Mini Victory

With the Mini victory we achieve the possibility of having a room the child's size. Electric bed with robust steel painted structure, with 4 articulated sections and electric elevator. Exterior in MDF wood in nice and pleasant colours. Also available model with legs. Availability of manufacturing beds under special measures.

MINI VICTORY WITH ELEVATOR CART

- Bed with steel slats
- 4 plans frame with 1 fixed and 3 articulated planes
- Electric elevator with H system
- With 3 electric motors
6000N
- Low voltage electrical system
(24V)
- Power
50 Watts
- Protection
Ip54
- Maximum user weight
125kg

TECHNICAL CHARACTERISTICS

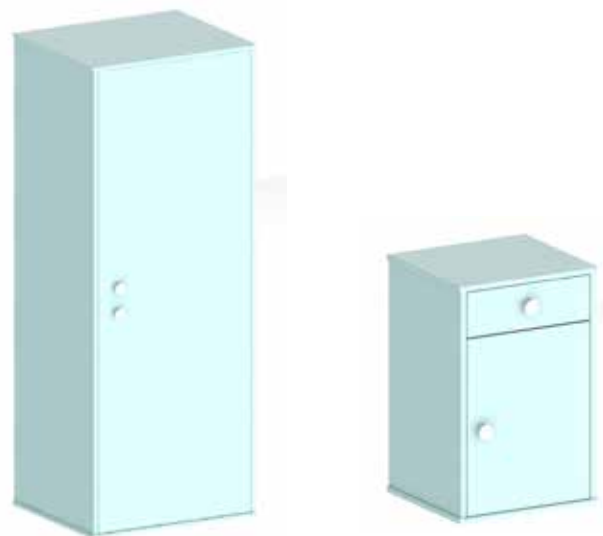

CLOSET
53 RP 9 1P

BEDSIDE TABLE
53 RP 9 1P

MEASUREMENTS

in cm / kg - tolerance +/- 1



MINI VICTORY ELECTRICAL

150

85

42-76

144

75

70°/25°/155°

COLOR



GROWTH



CONFIGURATION

Orthos Paediatrics
o f f e r s a l l
s o l u t i o n s t o
g r o w w i t h y o u . . .

ORTHOSMAIA XXI

C/ Manuel Nuñez no2 Ofic.9 Pl. 3 | 36203 Vigo | España
Tel: (+34) 886 312 806 |
Móvil: (+34) 678 994 993
E-mail: comercialespana@orthosxxi.com

ORTHOS XXI, Unipessoal Lda.

Rua de Santa Leocádia | 4809-012 Santa Leocádia de Briteiros
Guimarães | Portugal
Móvil: (+351) 253 470 276/ 77/ 70
E-mail: sofia.martins@orthosxxi.com
margarida.silva@orthosxxi.com
Fax: (+351) 253 470 278
info@orthosxxi.com

www.orthosxxi.com

by

ORTHOS
xxi
e u r o p e a n
i n c l u s i v e s o l u t i o n s

ORT HOS

inclusive solutions

WALKING AIDS

WALKING AIDS

Durability
Lightness
Color





**ORT
HOS**
XXI
e u r o p e a n
i n c l u s i v e s o l u t i o n s

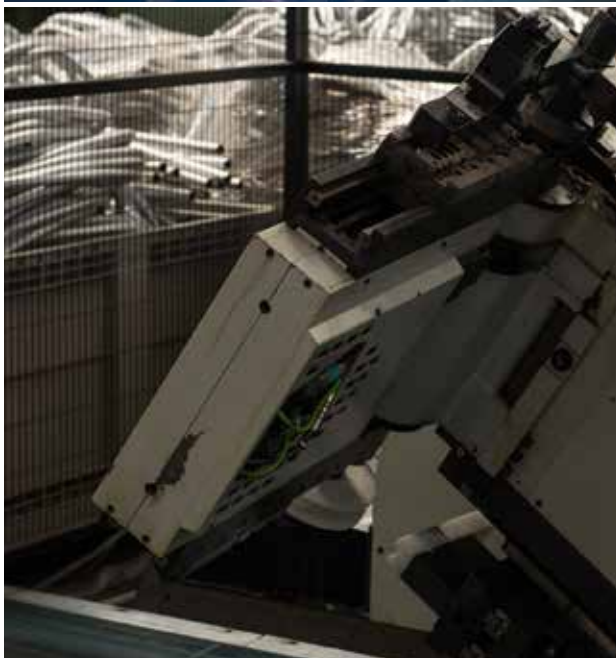

HISTORY

Orthos XXI originated from Conrado Dias Lda., a company founded in 1975 in Porto, Portugal.

In 1985, with great support from the owners Mr. Dias and Mrs. Marília, that the Mr. Ribeiro and Mrs. Zilda, decide to give continuity to the business of production and commercialization of walking aids, with the name of Ortomaia, thus concretizing an old aspiration of the Sñr. Ribeiro owning a business. This new company has the assiduous collaboration of Manuel and Luisa and with the timely help of their other children, thus naturally involving the whole family in the process. The bases that make up the current dynamic of Orthos XXI were launched, based on values of affection and proximity among all generations of collaborators.

Together with the production activity, the distribution of products from national and international companies of great importance in the Sector is included in its portfolio.

In 1989, a wheelchair production unit was acquired and integrated, giving rise to two independent and distinct production units, but with joint commercialization.

In 1996 it was necessary to expand, integrate and fully optimize the business, so it was built in Guimarães, a new warehouse with twice the area to accommodate all the aspects of the business. With a view to the expansion and evolution of the activity, in 2007 Several decisive steps are taken:

A process of professionalization of management begins by separating the shareholder structure from the management structure, thus formally creating Orthos XXI.

A production unit for Geriatric and Hospital beds was installed and the facilities for the double were expanded again.

Direct participation in the Spanish market began, creating a commercial structure, OrthosMaia XXI, in Spain.

They initiate and develop several commercial actions to expand and develop new markets and new businesses.

In 2012, a consolidation and product development department was created, which, together with the continuous improvement of the Organization, has allowed the product range to be substantially expanded.

In 2017/18 Orthos XXI, reformulates its marketing and commercial strategy, organizing its product portfolio in ten brands.

We have a base with a productive DNA that allows us to continue production in Europe and a brand-oriented trade strategy to be able to face the competition of multinationals and Asian importers.

QUALITY

The quality of the ORTHOS XXI products can be confirmed in the best hospitals and institutions, where they have chosen us. Most of our products are class I medical devices and bear the CE mark, according to the Community Directives 93/42 / CEE and 2007/47 / CE and are registered in the competent Authority, Infarmed. They are tested by accredited and independent entities, such as the IBV (Institute of Biomechanics of Valencia, in Spain). The company is also certified according to the EN ISO 9001 standard.

The value and qualification of human resources through the implementation of activity is training and updating in different areas have been strong bets of our company. ORTHOS XXI's main concern is the continuous improvement of production processes and services, as well as the improvement of the quality of its products, which allows us to better meet the needs and requirements of customers and users.

VALUE

We are driven by the conviction that, with our work, we contribute daily to improve the quality of life and to satisfy the needs of the users of our products and services. We prioritize an attitude of teamwork, flexibility and continuous improvement. We consider fundamental a constant investment in innovation and development of the products, currently counting on a team dedicated exclusively to this purpose.

These values support the presentation, in this new catalog, of some of the most recently developed novelties and, at the same time, to respond to the personalized needs of the users.



CRUTCHES AND CANES

pag 6-12

CRUTCHES

C1 Open Cuff, C8 Closed Cuff, C7 Steel, C1 Integral Open Cuff,
C8 Integral Closed Cuff

CANES

Foldable Aluminium Cane, Aluminium Cane, Blind Cane, Wood

CRUTCH

Axillary Crutch and Forearm Crutch

WALKERS

pag 14-15

WALKERS

Walkers A1/A2, Walker A3, Walker A4

WALKERS WITH WHEELS

Walker A5 y Walker A6

PYRAMIDS

pag 17-18

PYRAMIDS TRIPOD

Pyramid P1, Pyramid P3, Pyramid P5

PYRAMIDS QUADRIPOD

Pyramid P2, Pyramid P4, Pyramid P6 y Pyramid P10



C1 OPEN CUFF

Pag 06

C8 CLOSED CUFF

Pag 07

C7 STEEL

Pag 07

C1 INTEGRAL OPEN CUFF

Pag 08

C8 INTEGRAL CLOSED CUFF

Pag 09

FOLDABLE ALUMINIUM CANE

Pag 10

ALUMINIUM CANE

Pag 10

BLIND CANE

Pag 10

WOOD

Pag 11

AXILLARY CRUTCH

Pag 12

FOREARM CRUTCH

Pag 12

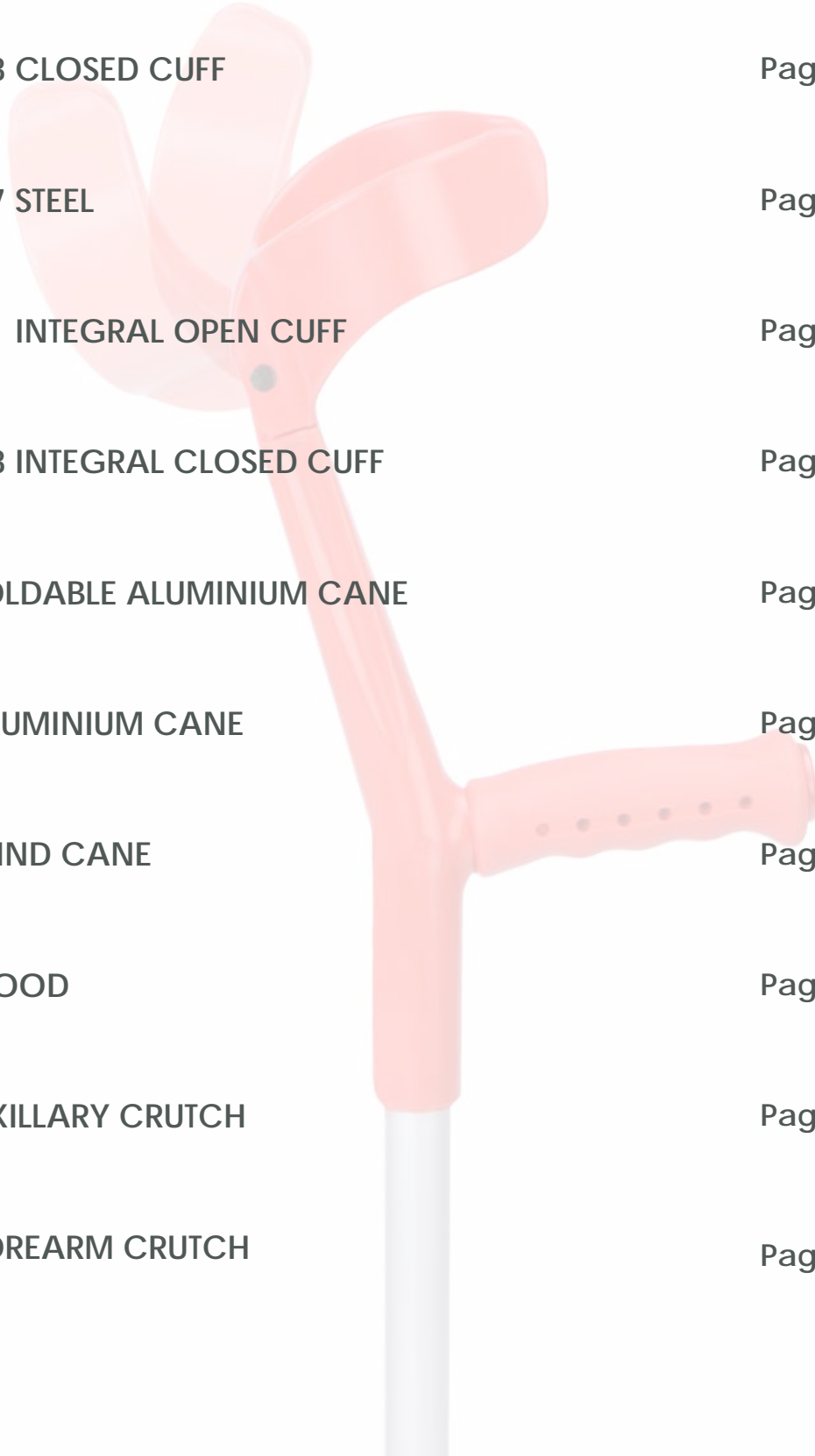

C1 OPEN CUFF



Aesthetic, durable, light, silent, are the characteristics of ORTHOS WALKING AIDS's crutches. With modern design y verifiable enduring, they are light due to components optimisation and to the aluminium's quality. Reduction of noise through an inner nylon component. Highly adaptable, with height adjusters. Adult crutches with open ring. High resistance and light aluminium structure. With 20mm anti slip rubber caps for safety. Natural or champagne tube colour. Height adjustable. Models with double adjustment for taller users. Reinforcable for users up to 125kg.



52 CN W/X AF PN ZZ
C1 Alum Crutch Open Cuff Nylon Handle Champagne

CARACTERÍSTICAS

C1 OPEN CUFF

Color - structure	natural, champagne
Regulation	standard, double



Soft handle



Handle protector (accessory)



Nylon handle



Double adjustment
52 CN X AF PN DA



Steel reinforced rubber ferrule



Open cuff



Large base rubber ferrule



Exhibitor

MEASUREMENTS

in cm/kg- tolerance +/-1

C1 NYLON HANDLE	90-115	68-93	22	100	0,4
C1 NYLON HANDLE DOUBLE ADJUSTMENT	90-125	68-93	22-32	100	0,5

C8 CLOSED CUFF

Adult crutches with articulated elbow. High resistance and light aluminium structure. With 22mm non-slip rubber tips for greater safety. Natural or champagne tube colour. Height adjustable. Models with double adjustment for taller users. Possibility of reinforcement for users up to 125kg.

C8 CLOSED CUFF

Color - structure
natural, champagne

Regulation
standard, double



Soft handle

Handle protector (accessory)

Nylon handle

MEASUREMENTS

in cm/kg- tolerance +/-1



C8 NYLON HANDLE	90-115	68-93	22	100	0,4
C8 DOBLE ADJUSTMENT	90-125	68-93	22-32	100	0,5



52 CN W/X AM PN ZZ

C8 Alum Crutch Closed Cuff Nylon Handle Champagne

C7 STEEL

Chromed steel structure, highly resistant and with soft handle. Height adjustable on the lower part. 16mm non-slip rubber tips.

C7 ACERO

Color - structure
grey



Articable cuff

Soft handle with reflector

MEASUREMENTS

in cm/kg- tolerance +/-1

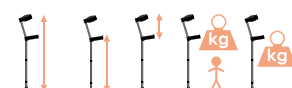

C7 SOFT HANDLE	90-115	68-93	22	140	0,7
----------------	--------	-------	----	-----	-----



52 CN Y FE PM ZZ

C7 Steel Crutch Closed Cuff Soft Handle Chromated

C1 INTEGRAL OPEN CUFF



52 CN X 2 AF PM ZZ

C1 Compl Mould Open Cuff Soft Handle Black

Light, innovative and carefully designed. The complete moulding crutches integrate new technology and materials to provide greater comfort and functionality. High resistance aluminium tube with complete moulding with soft handle with reflector. With 22mm non-slip rubber tips for greater safety. Available in various colors. Possibility to apply an extension for taller persons. Available in various colours. Models with shock absorber, very comfortable, to reduce the impact forces and help protect the joints.



Fixed cuff



Shock absorber



Clip



Steel reinforced rubber ferrule



Soft handle with reflector



Handle protector (accessory)

C1 INTEGRAL ARO FIJO

Color

black, blue, green, red, yellow



Model with shock absorber

Exhibitor

MEASUREMENTS

in cm/kg- tolerance +/-1



C1 SOFT HANDLE	90-115	68-93	22	150	0,6
C1 SHOCK ABSORBER	90-115	68-93	22	100	0,6

C8 INTEGRAL CLOSED CUFF



52 CN X 2 AM PM ZZ

C8 Compl Mould Closed Cuff Soft Handle Black

C8 INTEGRAL CLOSED CUFF

Color

black, blue, green, red, yellow

Light, innovative and carefully designed. The new complete moulding crutches integrate new technology and materials to offer added comfort and functionality. High resistance aluminium tube with complete moulding with a soft handle with reflector. With 22mm non-slip rubber tips for added safety. Height adjustable. Available in various colours. Models with shock absorber, very comfortable, to reduce the impact forces and help protect the joints.



Model with shock absorber



Articulating cuff



Shock absorber



Clip



Steel reinforced rubber ferrule



Handle protector (accessory)



Soft handle with reflector

MEASUREMENTS

in cm/kg- tolerance +/-1

	90-115	68-93	22	150	0,6
C8 SOFT HANDLE	90-115	68-93	22	150	0,6
C8 SHOCK ABSORBER	90-115	68-93	22	100	0,6

Aluminium cane, light and resistant. The height regulation enables the adaptability required for each user and the assurance that it is suitably used. With the foldable version, it becomes functional and practical when needed and imperceptible when not in use.

FOLDABLE ALUMINIUM CANE



52 BG X AD WS 00
Aluminium Foldable WS0015S

CANE

Foldable and height adjustable. T handle in wood.

Color
brown

MEASUREMENTS

in cm/kg- tolerance +/-1



FOLDABLE CANE 78-92 100



52 BG AD .04
Foldable cane (colors) B052606(Blue)

ALUMINIUM COLORS CANES

T handle. Foldable and height adjustable.

Color
yellow, green, blue, red, purple

MEASUREMENTS

in cm/kg- tolerance +/-1



CANE COLORS 85-94,5 112

ALUMINIUM CANE



52 BG X AL EX CT
B001 Aluminium Extensible - Natural

ALUMINIUM CANE

Aluminum cane with nylon handle, adjustable in height.

Color
natural, champagne, black

MEASUREMENTS

in cm/kg- tolerance +/-1



ALUMINIUM CANE B001 82-96,5 100

BLIND CANE



52 BG X IV DD
B006 Blind Cane

BLIND CANE

Highly sensitive. Very light and resistant. Folding. With noise absorption.

Color
grey

MEASUREMENTS

in cm/kg- tolerance +/-1



BLIND CANE 130 100

Canes made of beech wood, the most common walking aids. Their modern built provides durability, resistance, safety and aesthetics. Maximum user weight 100kg.

52BG1MDCCB31

B031
Brown cane with curved handle
With ring

52BG1MDCCB29

B029
Brown cane with curved handle
Without ring

52BG2MDCCB32

B032
Black cane with curved handle
With ring



B032 Wood - Curved Handle with Ring



52BG1MDCMB97

B097
Brown marble handle



52BG1MDCPB93

B093
Brown shell handle



52BG1MDSEB141

B141
Lady wood cane



52BG1MDSE95

B095
Lady wood cane



52BG1MDSEB100

B100
Brown lady handle with ring



52BG1MDCTB80

B080
Brown T handle without ring



52BG1MDCTB80

B080
Brown/black T handle
Without ring



52BG2MDCTOR

B002
Black T handle ny



52BG1MDCTOR

B005
Brown T handle nylon



52BG1MDCTB81

B081
Brown/black T handle with ring

AXILLARY CRUTCH



The axillary crutch is built in high resistance champagne anodised aluminium. With soft comfortable axillary support. Height adjustable in the base and in the handle.

AXILLARY CRUTCH

Color - structure
champagne
Rubber ferrule
22mm

52 ML W AL AP ZZ

Axillary Crutch Aluminium Champagne M1 (pair)

MEASUREMENTS

in cm/kg- tolerance +/-1

AXILARY CRUTCH	110-123	100	0.8
----------------	---------	-----	-----



FOREARM CRUTCH



The forearm crutch is made in steel and high resistance aluminium, adjustable in the lower part.

FOREARM CRUTCH

Color - structure
champagne
Rubber ferrule
22mm

52 CN W UB PM ZZ

Forearm Crutch (pair)

MEASUREMENTS

in cm/kg- tolerance +/-1

FOREARM CRUTCH	94-120	100	1,2
----------------	--------	-----	-----



WALKERS A1/A2

Pag 14

WALKER A3

Pag 14

WALKER A4

Pag 14

WALKER A5

Pag 15

WALKER A6

Pag 15

pag 14-15

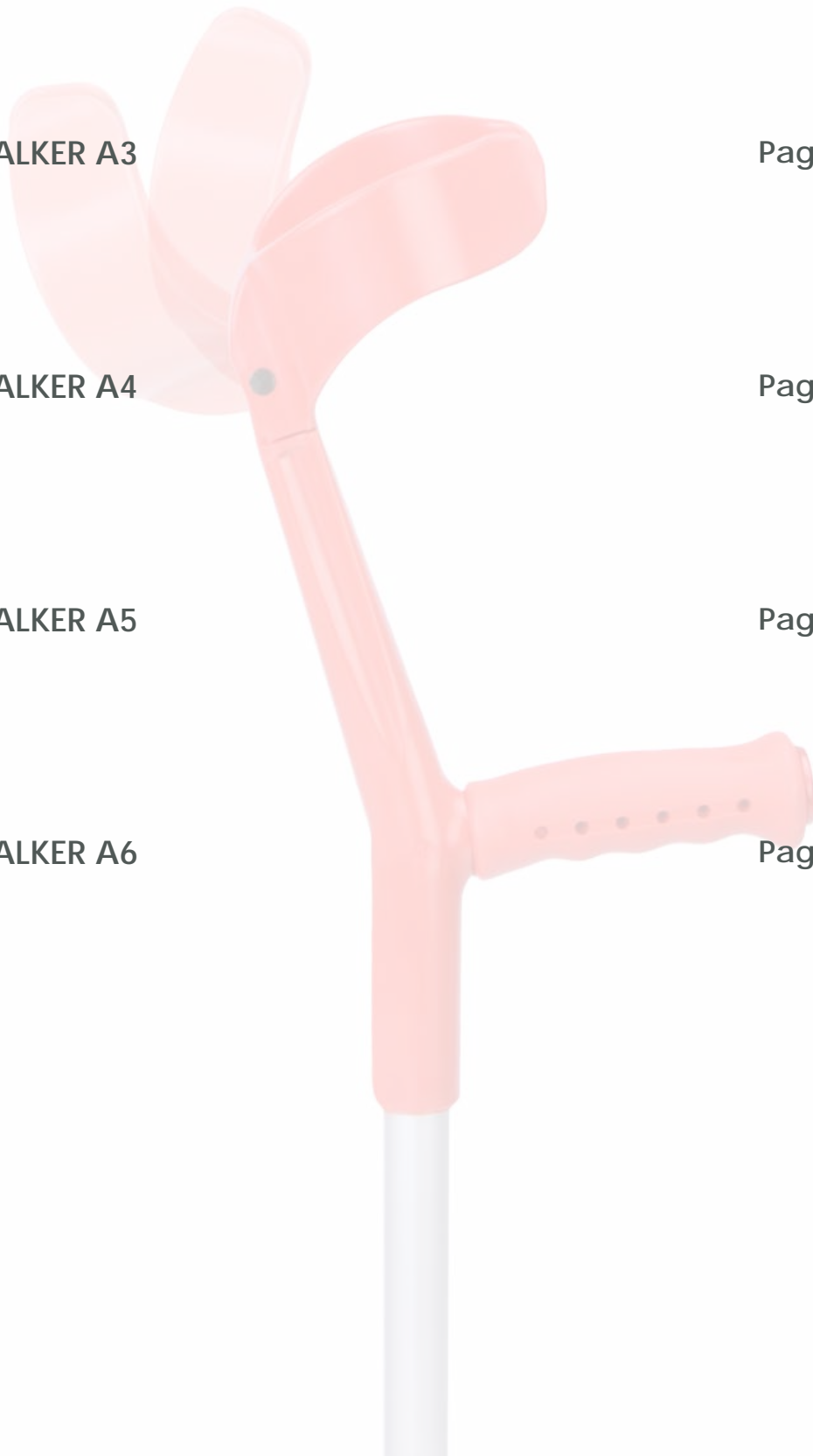

WALKERS A1/A2



52 AN W FX 01
A1 Fixed Walker G

Fix walker in aluminium. An excellent aid to safely train walking. Height adjustable allowing the proper adaptation to the user. A2 model for children and adults up to 1,50m height. Non-slip rubber tips.

A1/A2

Color
Champagne

MEASUREMENTS

in cm/kg- tolerance +/-1

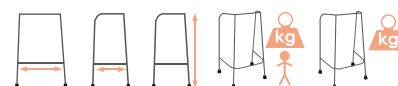

WALKER A1	54	43	88-98	100	1,8
WALKER A2	47	43	79-89	100	2

WALKER A3



52 AN X AR 01
A3 Articulated Walker (2 Levels)

Articulated 2 levels walker in aluminium. Adds to the characteristics of a fixed walker the added value of walking. Foldable and height adjustable. Non-slip rubber tips.

A3

Color
grey, champagne

MEASUREMENTS

in cm/kg- tolerance +/-1

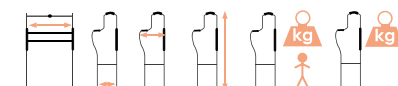

WALKER A3	58	43	56	89-99	100	2
-----------	----	----	----	-------	-----	---

WALKER A4



52 AN W AR 01
A4 Articulated Walker

Adds to the characteristics of a fix walker the added values of walking and standing help. It can change from fix to articulated through a manual device. Foldable and height adjustable. Non-slip rubber tips.

A4

Color
champagne

MEASUREMENTS

in cm/kg- tolerance +/-1



WALKER A4	58	43	82-92	100	2,8
-----------	----	----	-------	-----	-----

WALKER A5

A5 aluminium rollator with wheels, light and compact. Designed for comfort and user mobility. Its anatomical handles are height adjustable, offering complete safety. Inner wheels very suitable for narrow spaces. Non-slip rubber tips. Foldable for easy storage - still stands even when closed. A5 available in 4 colours: blue, red, green and yellow. A5 disponible en 4 colores: azul, rojo, verde y amarillo.

A5

Color - structure

grey

Color - upholstery

blue, red, green, yellow

Wheels

Ø100mm



MEASUREMENTS

in cm/kg- tolerance +/-1

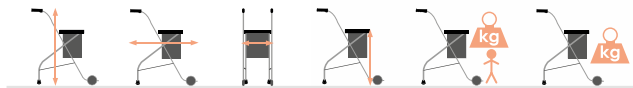

WALKER A5

79-89

68

49

58

100

3,8

52 AN X RD AS .04

A5 Walker with wheels with seat and bag (blue)

WALKER A6

A6, aluminium rollator, light and compact. Designed for comfort and user mobility. Its anatomical handles are height adjustable, offering complete safety. Inner wheels very suitable for narrow spaces. Non-slip rubber tips. Foldable for easy storage - still stands even when closed.

A6

Color - structure

grey

Color

black, blue, red, green, yellow

Wheels

Ø100mm



MEASUREMENTS

in cm/kg- tolerance +/-1

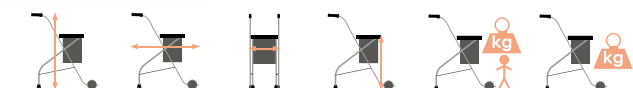

WALKER A6

79-89

68

49

58

100

3,2

52 AN X RD .02

A6 Walker with wheels (black)

PYRAMID P1

Pag 17

PYRAMID P3

Pag 17

PYRAMID P5

Pag 17

PYRAMID P2

Pag 18

pag 14-15

PYRAMID P4

Pag 18

PYRAMID P6

Pag 18

PYRAMID P10

Pag 18

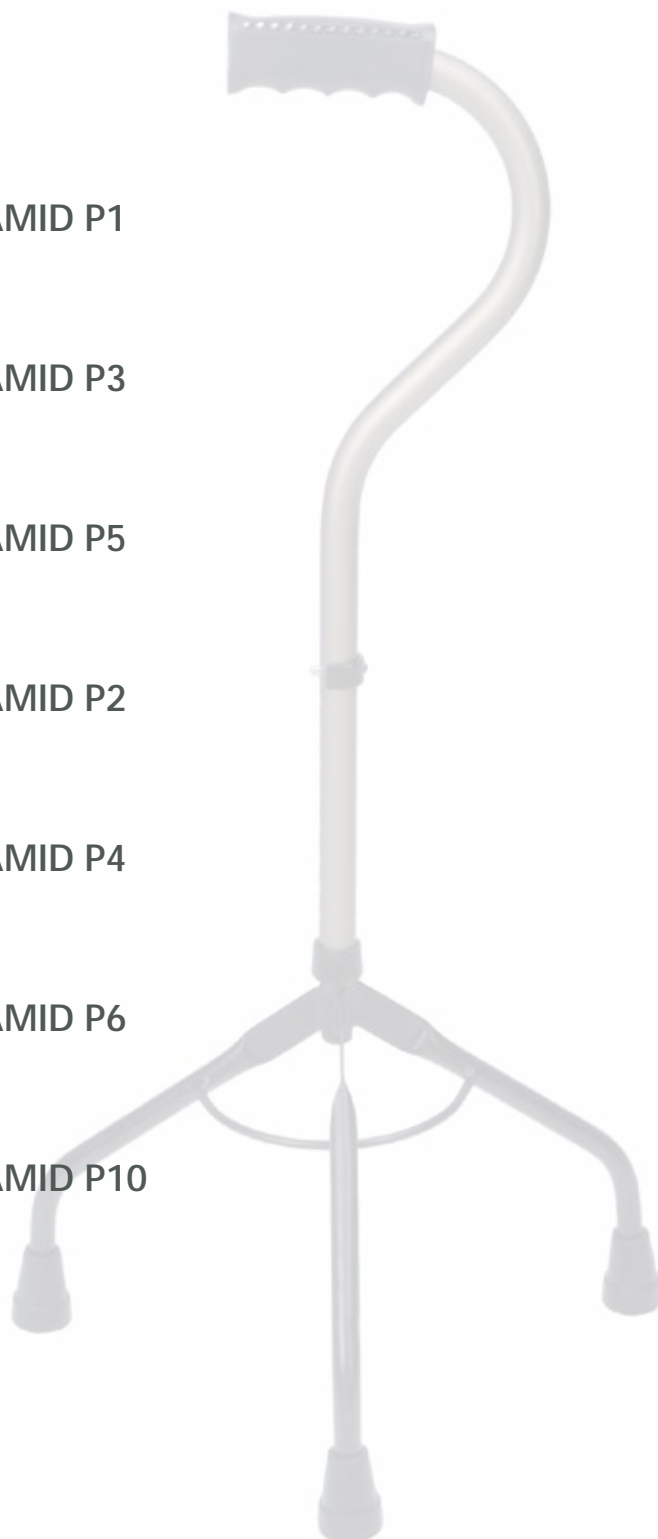

PYRAMID P1

Light anodised aluminium structure, champagne colour. With tree support points. Black steel base. Height adjustable. 14mm non-slip rubber tips for improved safety.

P1

Color
champagne

Handle
curved



52 PI W TP CC
P1 Tripod Curved Handle Champagne / Black Base

MEASUREMENTS

in cm/kg- tolerance +/-1

PYRAMID P1	80-95	100	1
------------	-------	-----	---

PYRAMID P3



52 PI W TP AF
P3 Tripod Open Cuff Champagne / Black Base

P3

Color
champagne

Handle
straight

Cuff
fixed

Light anodised aluminium structure, champagne colour. With tree support points. Black steel base. Height adjustable. 14mm non-slip rubber tips for improved safety.

MEASUREMENTS

in cm/kg- tolerance +/-1

PYRAMID P3	78-92	100	1,2
------------	-------	-----	-----

PYRAMID P5



52 PI W TP AM
P5 Tripod Closed Cuff Champagne / Black Base

P5

Color
champagne

Handle
straight

Cuff
articulable

Light anodised aluminium structure, champagne colour. With tree support points. Black steel base. Height adjustable. 14mm non-slip rubber tips for improved safety.

MEASUREMENTS

in cm/kg- tolerance +/-1

PYRAMID P5	80-95	100	1,2
------------	-------	-----	-----

PYRAMID P2



52 PI W QP CC

P2 Quadripod Curved Handle Champagne / Black Base

P2

Light anodised aluminium structure, champagne colour. With four support points. Black steel base. Height adjustable. 14mm non-slip rubber tips for improved safety.

Color	champagne
Handle	curved

MEASUREMENTS

in cm/kg- tolerance +/-1

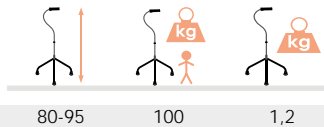

PYRAMID P2

80-95

100

1,2

PYRAMID P4



52 PI W QP AF

P4 Quadripod Open Cuff Champagne / Black Base

P4

Light anodised aluminium structure, champagne colour. With four support points. Black steel base. Height adjustable. 14mm non-slip rubber tips for improved safety.

Color	champagne
Handle	straight
Cuff	fixed

MEASUREMENTS

in cm/kg- tolerance +/-1



PYRAMID P4

78-92

100

1,4

PYRAMID P6



52 PI W QP AM

P6 Quadripod Closed Cuff Champagne / Black Base

P6

Light anodised aluminium structure, champagne colour. With four support points. Black steel base. Height adjustable. 14mm non-slip rubber tips for improved safety.

Color	champagne
Handle	straight
Cuff	articulable

MEASUREMENTS

in cm/kg- tolerance +/-1

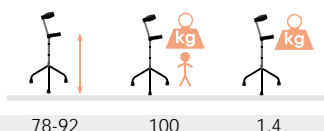

PYRAMID P6

78-92

100

1,4

PYRAMID P10



52 PI Y QP BE

P10 Quadripod Narrow Base

P10

Chromed steel structure, light y compact, with four support points. Ideal to climb stairs. Height adjustable. 14mm non-slip rubber tips for improved safety.

Color	grey
Handle	straight

MEASUREMENTS

in cm/kg- tolerance +/-1

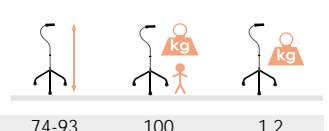

PYRAMID P10

74-93

100

1,2

DURABILITY



LIGHTNESS



COLOR

*At Orthos Walking
Aids you will
always find **life**
long crutches and
walkers, **more**
than 30 years in
our hands...*

ORTHOSMAIA XXI

C/ Manuel Nuñez no2 Ofic.9 Pl. 3 I 36203 Vigo I España
Tel: (+34) 886 312 806
Móvil: (+34) 678 994 993
E-mail: comercialespana@orthosxxi.com

ORTHOS XXI, Unipessoal Lda.

Rua de Santa Leocádia I 4809-012 Santa Leocádia de Briteiros
Guimarães I Portugal
Phone: (+351) 253 470 276/ 77/ 70
E-mail: sofia.martins@orthosxxi.com
margarida.silva@orthosxxi.com
Fax: (+351) 253 470 278
info@orthosxxi.com

www.orthosxxi.com

by

ORTHOS
xxi
e u r o p e a n
i n c l u s i v e s o l u t i o n s

ORT HOS

inclusive solutions
GERIATRICS

GERIATRICS

*Environment
Modularity
Durability*



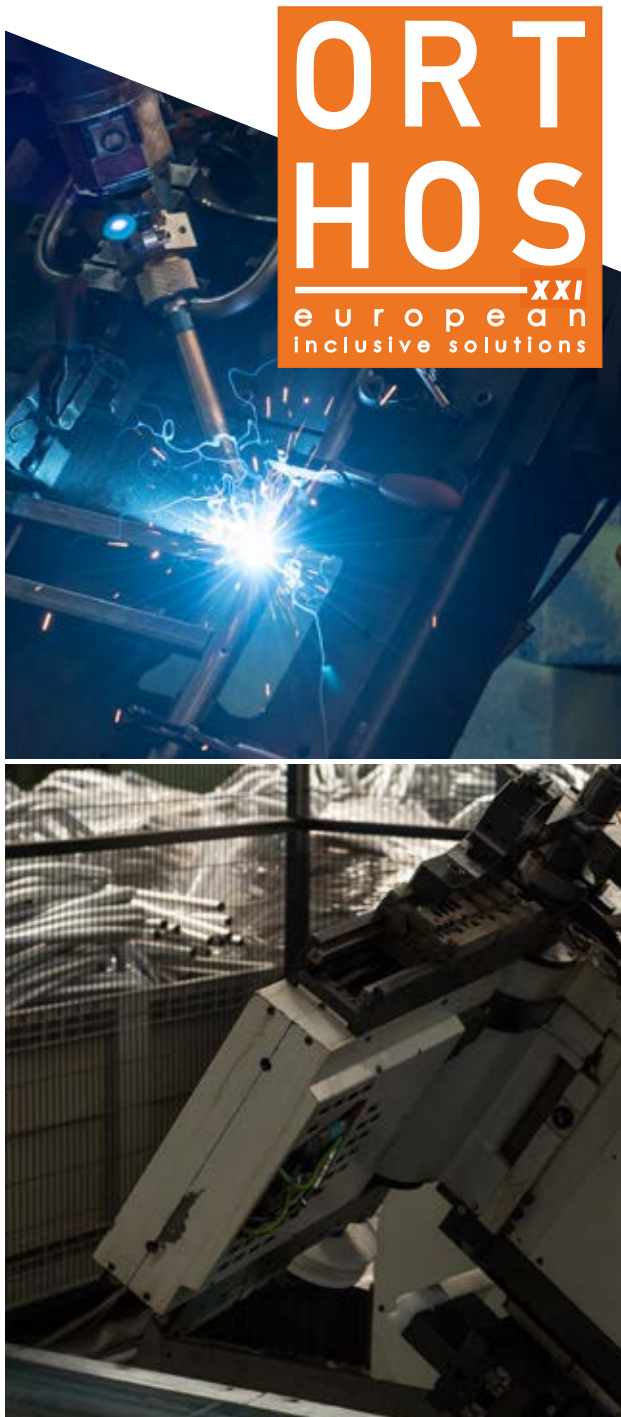

ORTHOS

XXI
european
inclusive solutions

HISTORY

Orthos XXI originated from Conrado Dias Lda., a company founded in 1975 in Porto, Portugal.

In 1985, with great support from the owners Mr. Dias and Mrs. Marília, that the Mr. Ribeiro and Mrs. Zilda, decide to give continuity to the business of production and commercialization of walking aids, with the name of Ortomaia, thus concretizing an old aspiration of the Sñr. Ribeiro owning a business.

This new company has the assiduous collaboration of Manuel and Luisa and with the timely help of their other children, thus naturally involving the whole family in the process. The bases that make up the current dynamic of Orthos XXI were launched, based on values of affection and proximity among all generations of collaborators.

Together with the production activity, the distribution of products from national and international companies of great importance in the Sector is included in its portfolio.

In 1989, a wheelchair production unit was acquired and integrated, giving rise to two independent and distinct production units, but with joint commercialization.

In 1996 it was necessary to expand, integrate and fully optimize the business, so it was built in Guimarães, a new warehouse with twice the area to accommodate all the aspects of the business. With a view to the expansion and evolution of the activity, in 2007 Several decisive steps are taken:

A process of professionalization of management begins by separating the shareholder structure from the management structure, thus formally creating Orthos XXI.

A production unit for Geriatric and Hospital beds was installed and the facilities for the double were expanded again.

Direct participation in the Spanish market began, creating a commercial structure, OrthosMaia XXI, in Spain.

They initiate and develop several commercial actions to expand and develop new markets and new businesses.

In 2012, a consolidation and product development department was created, which, together with the continuous improvement of the Organization, has allowed the product range to be substantially expanded.

In 2017/18 Orthos XXI, reformulates its marketing and commercial strategy, organizing its product portfolio in ten brands.

We have a base with a productive DNA that allows us to continue production in Europe and a brand-oriented trade strategy to be able to face the competition of multinationals and Asian importers.

QUALITY

The quality of the ORTHOS XXI products can be confirmed in the best hospitals and institutions, where they have chosen us. Most of our products are class I medical devices and bear the CE mark, according to the Community Directives 93/42/CEE and 2007/47/CE and are registered in the competent Authority, Infarmed. They are tested by accredited and independent entities, such as the IBV (Institute of Biomechanics of Valencia, in Spain). The company is also certified according to the EN ISO 9001 standard.

The value and qualification of human resources through the implementation of activity is training and updating in different areas have been strong bets of our company. ORTHOS XXI's main concern is the continuous improvement of production processes and services, as well as the improvement of the quality of its products, which allows us to better meet the needs and requirements of customers and users.

VALUE

We are driven by the conviction that, with our work, we contribute daily to improve the quality of life and to satisfy the needs of the users of our products and services. We prioritize an attitude of teamwork, flexibility and continuous improvement. We consider fundamental a constant investment in innovation and development of the products, currently counting on a team dedicated exclusively to this purpose.

These values support the presentation, in this new catalog, of some of the most recently developed novelties and, at the same time, to respond to the personalized needs of the users.



BEDROOM

pag 6-27

BEDS

ILLUSION

Illusion Electric- Daisy, Illusion Electric 2 Parts- Daisy, Illusion Hi-lo Doble H- Daisy

FANTASY

Fantasy Manual- Iris, Fantasy Electric-Iris, Fantasy Hi-lo Scissor- Iris, Fantasy Hi-lo Doble H- Iris

VICTORY

Victory Manual- Violet, Victory Electric- Violet, Victory Hi-lo Scissor- Iris, Victory Hi-lo Doble H- Violet, Victory Hi-lo Doble H- Chamelia, Victory Hi-lo Doble H- Jasmine

MISTERY

Mistery Electric- Violet, Mistery Hi-lo Doble H- Jasmine

TRIUMPH

Triumph Ill, Triumph Fant, Triumph Vict

TRIUMPH PLUS

Triumph Plus Ill, Triumph Plus Mist

DESIRE

Desire Ill, Desire Plus Vict

ALZHEIMER BED

Components and Accesories;

TABLES

Bedside Table, Bedside Table with Bed Table, Bed Table;

OTHER FURNITURE

Chest, Mirror, 1 Door Closet, 2 Doors Closet;

LIVING ROOM

pag 28-36

CHOUCHES

OPORTO

Oporto Light Electric/Manual, Oporto Light Rise and Recline;

EXOTIC

Exotic Electric/Manual, Exotic Rise and Recline;

SAVANNAH

Savannah Manual/Electric, Savannah Rise and Recline;

SAVANNAH PLUS

Savannah Plus Manual/Electric, Savannah Plus Rise and Recline;

Siamês, Angorá;

CHAIRS

Bolinês 1 Seat, Bolinês Relax, Bolinês 2 Seats, Bolinês 3 Seats;

OTHER FURNITURE

DINNING ROOM

pag 37-40

Simple Chair, Comfort Chair, Dining table, Sideboard, Finishings;

PILLS ORGANIZERS

pag 41-43

Trolley for Pills, Pills Organizers;

DAILY LIFE HELPERS

pag 44-46

Daily Life Helpers to Eat, Daily Life Helpers to Dress, Other Daily Life Helpers;



BEDS

ILLUSION ELECTRIC- DAISY	Pag 06
ILLUSION ELECTRIC 2 PARTS- DAISY	Pag 06
ILLUSION HI-LO DOUBLE H- DAISY	Pag 07
FANTASY MANUAL- IRIS	Pag 08
FANTASY ELECTRIC- IRIS	Pag 08
FANTASY HI-LO SCISSOR- IRIS	Pag 09
FANTASY HI-LO DOUBLE H- IRIS	Pag 09
VICTORY MANUAL- VIOLET	Pag 10
VICTORY ELECTRIC- VIOLET	Pag 10
VICTORY HI-LO SCISSOR- IRIS	Pag 11
VICTORY HI-LO DOUBLE H- VIOLET	Pag 11
VICTORY HI-LO DOUBLE H- CHAMELIA	Pag 12
VICTORY HI-LO DOUBLE H- JASMINE	Pag 13
MISTERY ELECTRIC- VIOLET	Pag 14
MISTERY HI-LO DOUBLE H- JASMINE	Pag 15
TRIUMPH ILL	Pag 16
TRIUMPH FANT	Pag 16
TRIUMPH VICT	Pag 17
TRIUMPH PLUS ILL	Pag 18
TRIUMPH PLUS MIST	Pag 19
DESIRE ILL	Pag 20
DESIRE PLUS VICT	Pag 20
ALZHEIMER BED	Pag 21
COMPONENTS AND ACCESSORIES	Pag 22-24

TABLES

BEDSIDE TABLE	Pag 25
BEDSIDE TABLE WITH BED TABLE	Pag 25
BED TABLE	Pag 26

OTHER FURNITURE

CHEST WITH 4 DRAWERS	Pag 26
MIRROR	Pag 27
TABLE DESK	Pag 27
1 DOOR CLOSET	Pag 27
2 DOORS CLOSET	Pag 27

ILLUSION ELECTRIC- DAISY



Electric articulated bed with an epoxy painted steel frame 50x20x2mm, conceived and recommended for environments with reduced bacteriological hazards. With 4-Section mattress support, three articulated sections and a fixed one, with wooden slats. Electric actuation of head and foot sections with a central low tension motor. Daisy Head- and foot boards in chipboard and melamine beech. Fixed legs.

58 CM 1 IL EL RA DS

ILLUSION Elect Bed 3X 4Plan - Height adjustable legs - Head Board DAISY Beech

DIMENSIONS

in cm/kg - tolerance +/-1

ILLUSION ELECTRIC

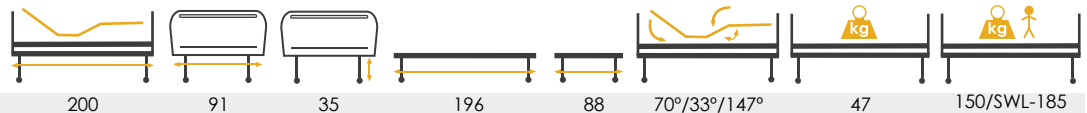

ILLUSION ELECTRIC 2 PARTS- DAISY



Electric articulated bed with an epoxy painted steel frame 50x20x2mm, conceived and recommended for environments with reduced bacteriological hazards. ILLUSION 2-Parts frame is made of 2 assembling parts, for ease of transport and storage. With 4-Section mattress support, three articulated sections and a fixed one, with wooden slats. Electric actuation of head and foot sections with a central low tension motor. Daisy Head- and foot boards in chipboard and melamine beech. Height adjustable legs.

58 CM 1 I2 EL RA DS

ILLUSION 2 Elect Bed 3X 4Plan - Height adjustable legs - Head Board

DIMENSIONS

in cm/kg - tolerance +/-1

ILLUSION ELECTRIC 2 PARTS

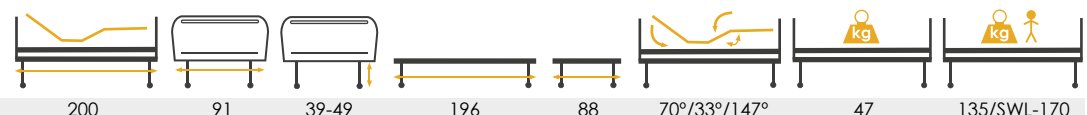

ILLUSION HI-LO DOUBLE H- DAISY



58 CM 1 IL EE 2H DS

ILLUSION Bed - Scissor lift Elect 3X 4Plan - Head Board DAISY Beech

Electric articulated bed with an epoxy painted steel frame 50x20x2mm, conceived and recommended for environments with reduced bacteriological hazards. With 4-Section mattress support, three articulated sections and a fixed one, with wooden slats. Electric actuation of head and foot sections with a central low tension motor. Robust and stable Double H model elevator, with 125mm wheels, 2 with brakes, ensures robustness and lateral stability Daisy Head and foot boards in chipboard and melamine beech.



DIMENSIONS

in cm/kg - tolerance +/-1

ILLUSION HI-LO DOUBLE H

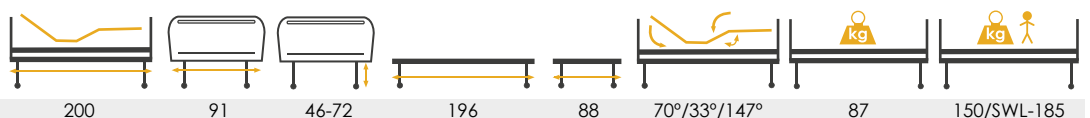

FANTASY MANUAL- IRIS



58 CM 1 FT MN RA IR

FANTASY Bed Manual 4Plan - Height adjustable legs

FANTASY, line recommended for environments with reduced bacteriological hazards. FANTASY line is simple and modern, making both the user' and the carer's movements easy. Epoxy painted steel frame 50x25x2mm. With 4-Section mattress support, three articulated sections and a fixed one, with wooden slats. Manual actuation of head and foot sections with 2 highly resistant retractile cranks Double slat in the fixed section. Iris Head- and foot boards in chipboard and melamine beech. With 2 accessories supports in the structure. With 3 legs options (fixed, height adjustable and 100mm wheels). Modular design, this model allows the bed to easily convert from manual to electric.

DIMENSIONS

in cm/kg - tolerance +/-1

FANTASY MANUAL

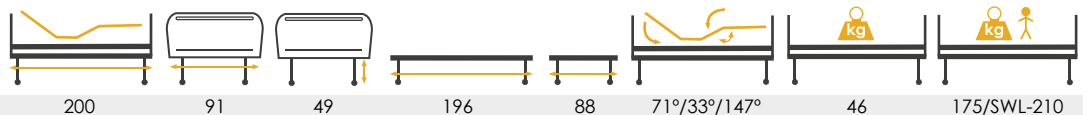

FANTASY ELECTRIC- IRIS



58 CM 1 FT EL RA IR

FANTASY Elect Bedric Height Adj legs (min 2Beds)

FANTASY, line recommended for environments with reduced bacteriological hazards. FANTASY line is simple and modern, making both the user' and the carer's movements easy. Epoxy painted steel frame 50x25x2mm. With 4-Section mattress support, three articulated sections and a fixed one, with wooden slats. Electric actuation of head and foot sections with 2 low tension electric motors. Double slat in the fixed section. Iris Head- and foot boards in chipboard and melamine beech. With 2 accessories supports in the structure. With 3 legs options (fixed, height adjustable and 100mm wheels). Modular design, this model allows the bed to easily convert from fixed height bed into a hi-low bed, adding the elevator.

DIMENSIONS

in cm/kg - tolerance +/-1

FANTASY ELECTRIC

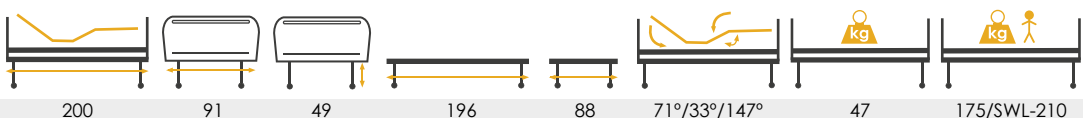

FANTASY HI-LO SCISSOR- IRIS

FANTASY, line recommended for environments with reduced bacteriological hazards. FANTASY line is simple and modern, making both the user' and the carer's movements easy. Epoxy painted steel frame 50x25x2mm. With 4-Section mattress support, three articulated sections and a fixed one, with wooden slats. Electric actuation of head and foot sections with 2 low tension electric motors. Double slat in the fixed section. Iris Head- and foot boards in chipboard and melamine beech. With 2 accessories supports in the structure. Resistant scissor model elevator, with 100mm wheels, 2 with brakes.



58 CM 1 FT EE TS IR
FANTASY Bed w/Elevation

DIMENSIONS

in cm/kg - tolerance +/-1

FANTASY HI-LO SCISSOR

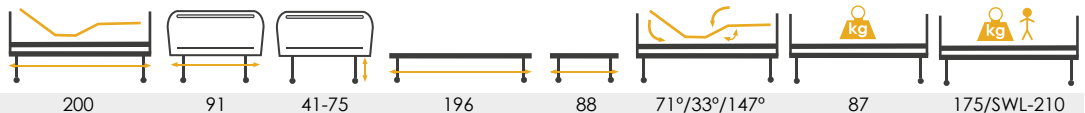

200

91

41-75

196

88

71°/33°/147°

87

175/SWL-210

FANTASY HI-LO DOUBLE H- IRIS

FANTASY, line recommended for environments with reduced bacteriological hazards. FANTASY line is simple and modern, making both the user' and the carer's movements easy. Epoxy painted steel frame 50x25x2mm. With 4-Section mattress support, three articulated sections and a fixed one, with wooden slats. Electric actuation of head and foot sections with 2 low tension electric motors. Double slat in the fixed section. Iris Head- and foot boards in chipboard and melamine beech. With 2 accessories supports in the structure. Robust and stable Double H model elevator, with 125mm wheels, 2 with brakes, ensures robustness and lateral stability.



58 CM 1 FT EE 2H IR
FANTASY Elect bed with elev 4 sections Melamina head board

DIMENSIONS

in cm/kg - tolerance +/-1

FANTASY HI-LO DOUBLE H

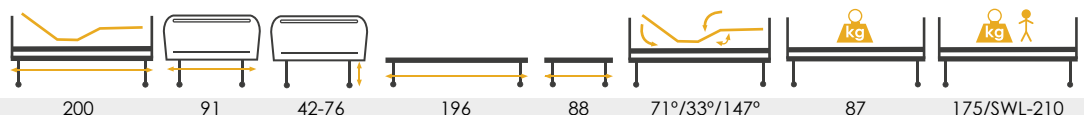

200

91

42-76

196

88

71°/33°/147°

87

175/SWL-210

VICTORY MANUAL- VIOLET



VICTORY, line recommended for environments with medium/high bacteriological hazards, such as clinics, nursing homes, continued care units. VICTORY line is very robust and enables many configuration options, thus suitable to adapt both to the user' and to the carer's specific needs. Epoxy painted steel frame 60x30x1,5mm. With 4-Section mattress support, three articulated sections and a fixed one, with polymer fibre slats. Manual actuation of head and foot sections with 2 highly resistant retractile cranks. Violet head- and foot boards in MDF (medium density fibreboard), rounded and varnished beech finishing. With 2 accessories supports in the structure. With 3 legs options (fixed, height adjustable and 100mm wheels). Modular design, this model allows the bed to easily convert from manual to electric.

58 CM 1 VT MN RA VI

VICTORY bed - Manual 3X 4Plan - height adjustable legs Violet

DIMENSIONS

in cm/kg - tolerance +/-1

VICTORY MANUAL

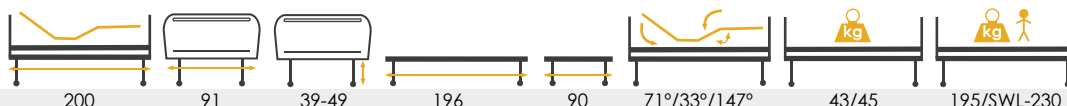

VICTORY ELECTRIC- VIOLET

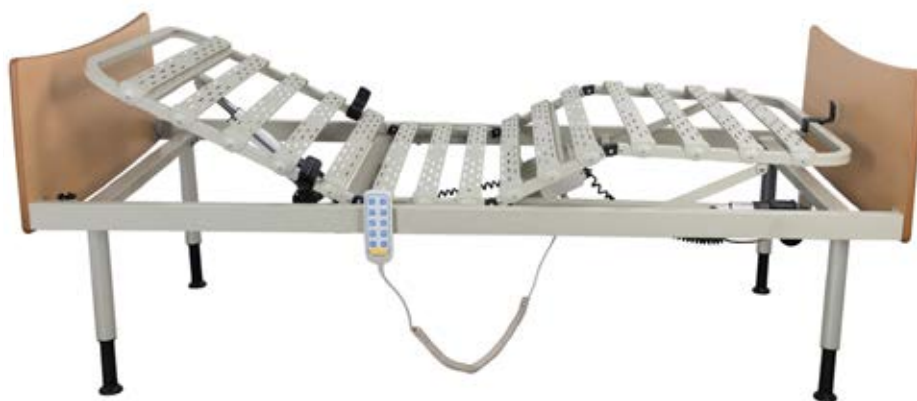

VICTORY, line recommended for environments with medium/high bacteriological hazards, such as clinics, nursing homes, continued care units. VICTORY line is very robust and enables many configuration options, thus suitable to adapt both to the user' and to the carer's specific needs. Epoxy painted steel frame 60x30x1,5mm. With 4-Section mattress support, three articulated sections and a fixed one, with polymer fibre slats. Electric actuation of head and foot sections with 2 low tension 6000N motors operated by an easy and intuitive remote control. Violet head- and foot boards in MDF (medium density fibreboard) rounded and varnished beech finishing. With 2 accessories supports in the structure. With 3 legs options (fixed, height adjustable and 100mm wheels). Modular design, this model allows the bed to easily convert from fixed height bed into a hi-low bed, adding the elevator.

58 CM 1 VT EL RA VI

VICTORY Elect Bed 3X 4Plan - height adjustable legs - Head Board VIOLET Beech

DIMENSIONS

in cm/kg - tolerance +/-1

VICTORY ELECTRIC

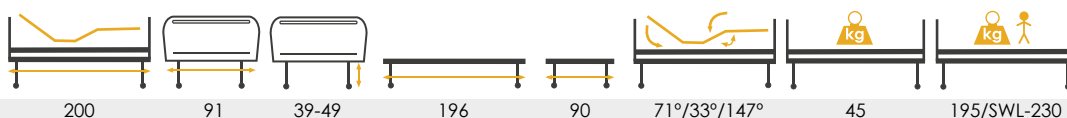

VICTORY HI-LO SCISSOR- IRIS

VICTORY, line recommended for environments with medium/high bacteriological hazards, such as clinics, nursing homes, continued care units. VICTORY line is very robust and enables many configuration options, thus suitable to adapt both to the user' and to the carer's specific needs. Epoxy painted steel frame 60x30x1,5mm. With 4-Section mattress support, three articulated sections and a fixed one, with polymer fibre slats. Electric actuation of head and foot sections with 2 low tension 6000N motors operated by an easy and intuitive remote control. Iris head- and foot boards in MDF (medium density fibre-board) rounded and varnished beech finishing. With 2 accessories supports in the structure. Resistant scissor model elevator, with 100mm wheels, 2 with brakes..



58 CM 1 VT EE TS IR

VICTORY Bed - scissor lift Elect 3X 4Plan - Head Board IRIS Beech

DIMENSIONS

in cm/kg - tolerance +/-1

VICTORY HI-LO SCISSOR

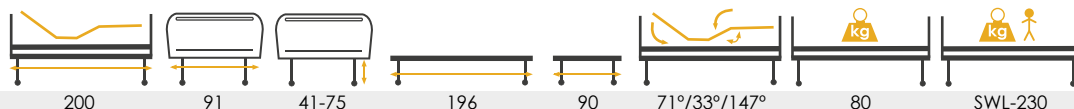

VICTORY HI-LO DOUBLE H- VIOLET

VICTORY, line recommended for environments with medium/high bacteriological hazards, such as clinics, nursing homes, continued care units. VICTORY line is very robust and enables many configuration options, thus suitable to adapt both to the user' and to the carer's specific needs. Epoxy painted steel frame 60x30x1,5mm. With 4-Section mattress support, three articulated sections and a fixed one, with polymer fibre slats. Electric actuation of head and foot sections with 2 low tension 6000N motors operated by an easy and intuitive remote control. Violet head- and foot boards in MDF (medium density fibre-board) rounded and varnished beech finishing. With 2 accessories supports in the structure. Robust and stable Double H model elevator, with 125mm wheels, 2 with brakes, ensures robustness and lateral stability.



58 CM 1 VT EE 2H VI

VICTORY Bed - 2H lift Elect 3X 4Plan - Head Board VIOLET Beech

DIMENSIONS

in cm/kg - tolerance +/-1

VICTORY HI-LO DOUBLE H

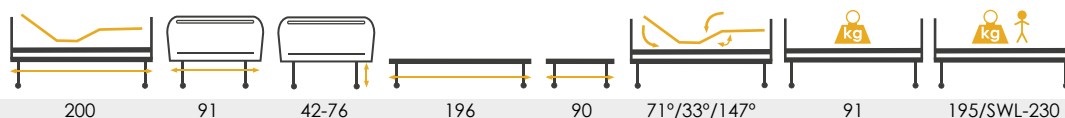

VICTORY HI-LO DOUBLE H- CHAMELIA



58 CM 1 VT EE 2H CH GM

VICTORY Elect Bed 3X 4Plan - 4 Rd w/brake - Head Board CHAMELIA Beech + Macamina

VICTORY, line recommended for environments with medium/high bacteriological hazards, such as clinics, nursing homes, continued care units. VICTORY line is very robust and enables many configuration options, thus suitable to adapt both to the user' and to the carer's specific needs. Epoxy painted steel frame 60x30x1,5mm. With 4-Section mattress support, three articulated sections and a fixed one, with polymer fibre slats. Electric actuation of head and foot sections with 2 low tension 6000N motors operated by an easy and intuitive remote control. Chamelia head- and foot boards in MDF (medium density fibreboard) rounded and varnished beech finishing. With 2 accessories supports in the structure. Solid wood side rails. Robust and stable Double H model elevator, with 125mm wheels, 2 with brakes, ensures robustness and lateral stability.



DIMENSIONS

in cm/kg - tolerance +/-1

VICTORY HI-LO DOUBLE H



VICTORY HI-LO DOUBLE H- JASMINE



58 CM 1 VT EE 2H JA GM

VICTORY Bed - 2H lift Elect 3X 4Plan - Head Board JASMINE Beech + Solid side rails

VICTORY, line recommended for environments with medium/high bacteriological hazards, such as clinics, nursing homes, continued care units. VICTORY line is very robust and enables many configuration options, thus suitable to adapt both to the user' and to the carer's specific needs. Epoxy painted steel frame 60x30x1,5mm. With 4-Section mattress support, three articulated sections and a fixed one, with polymer fibre slats. Electric actuation of head and foot sections with 2 low tension 6000N motors operated by an easy and intuitive remote control. Jasmine head- and foot boards in MDF (medium density fibreboard) rounded and varnished beech finishing. With 2 accessories supports in the structure. Solid wood side rails. Robust and stable Double H model elevator, with 125mm wheels, 2 with brakes, ensures robustness and lateral stability.



DIMENSIONS

in cm/kg - tolerance +/-1

VICTORY HI-LO DOUBLE H

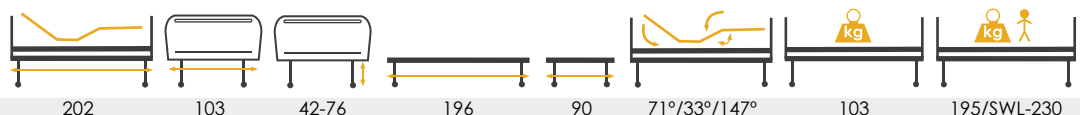

MISTERY ELECTRIC- VIOLET



58 CM 1 MY EL RA VI

Cm MISTERY Elet 4PL-Pés Rg Alt-Cb VIOLET Beech

MISTERY, line recommended for environments with medium/high bacteriological hazards, such as clinics, nursing homes, continued care units. Very robust, enables many configuration options, thus suitable to adapt both to the user' and to the carer's specific needs. Epoxy painted steel frame 60x30x1,5mm. MISTERY frame is made of 2 assembling parts, for ease of transport and storage. With 4-Section mattress support, three articulated sections and a fixed one, with polymer fibre slats. Electric actuation of head and foot sections with 2 low tension 6000N motors operated by an easy and intuitive remote control. Violet head and foot boards in MDF (medium density fibreboard) rounded and varnished beech finishing. With 2 accessories supports in the structure. With 3 legs options (fixed, height adjustable and 100mm wheels). Modular design, this model allows the bed to easily convert from fixed height bed into a hi-low bed, adding the elevator.

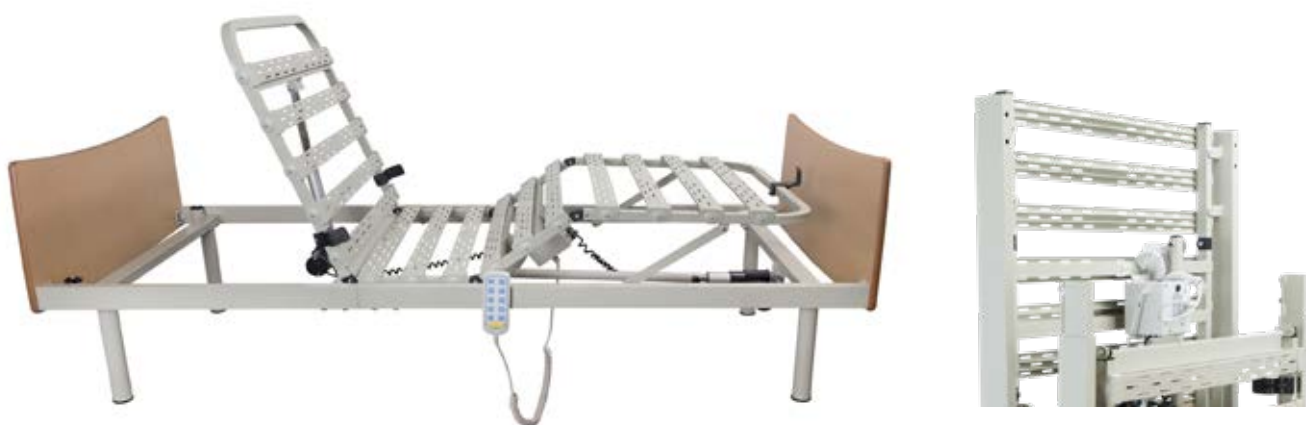

DIMENSIONS

in cm/kg - tolerance +/-1

MISTERY ELECTRIC

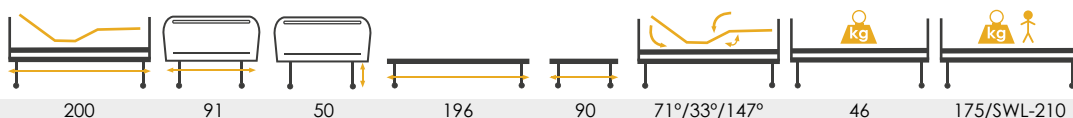

MISTERY HI-LO DOUBLE H- JASMINE



58 CM 1 MY EE 2H JA GM

MISTERY - 2H lift Elect 3X 4Plan - Head Board JASMINE Beech + Solid side rails

MISTERY, line recommended for environments with medium/high bacteriological hazards, such as clinics, nursing homes, continued care units. Very robust, enables many configuration options, thus suitable to adapt both to the user' and to the carer's specific needs. Epoxy painted steel frame 60x30x1,5mm. MISTERY frame is made of 2 assembling parts, for ease of transport and storage. With 4-Section mattress support, three articulated sections and a fixed one, with polymer fibre slats. Electric actuation of head and foot sections with 2 low tension 6000N motors operated by an easy and intuitive remote control. Jasmine head- and foot boards in MDF (medium density fibreboard) rounded and varnished beech finishing. With 2 accessories supports in the structure. Solid wood side rails. Robust and stable Double H model elevator, with 125mm wheels, 2 with brakes, ensures robustness and lateral stability.



DIMENSIONS

in cm/kg - tolerance +/-1

MISTERY HI-LO DOUBLE H

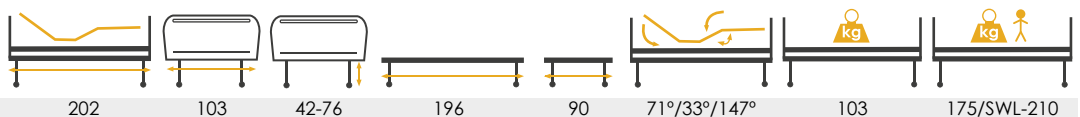

TRIUMPH ILL



Electric articulated bed with an epoxy painted steel frame 50x20x2mm, conceived and recommended for environments with reduced bacteriological hazards. With 4-Section mattress support, three articulated sections and a fixed one, with wooden slats. Electric actuation of head and foot sections with a central low tension motor. Triumph Head- and foot boards with in-built motors for hi-lo, with 4 100mm wheels, all with brakes.



Option Triumph ILL2

58 CM 1 TR EL RD IL

TRIUMPH bed - elevator ILL Beech

DIMENSIONS

in cm/kg - tolerance +/-1

TRIUMPH ILL

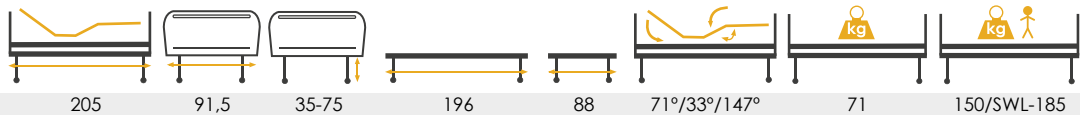

TRIUMPH FAN



Line recommended for environments with reduced bacteriological hazards. A simple and modern line, making both the user's movements and the carer's activities easy. Epoxy painted steel frame 50x20x2mm. With 4-Section mattress support, three articulated sections and a fixed one, with wooden slats. Electric actuation of head and foot sections with 2 low tension electric motors. Double slat in the fixed section. Triumph Head- and foot boards with in-built motors for hi-lo, with 4 100mm wheels, all with brakes.



Trendelenburg Lock Control

58 CM 1 TR EL RD FT

TRIUMPH bed - elevator FANT Beech

DIMENSIONS

in cm/kg - tolerance +/-1

TRIUMPH FANTASY

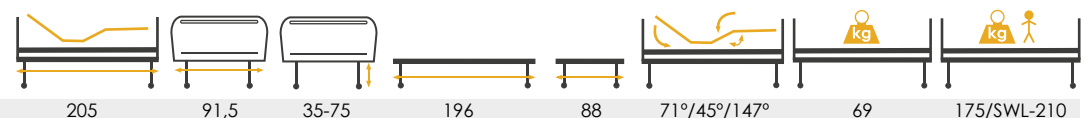



58 CM 1 TR EL RD VT
TRIUMPH bed - elevator VICT Beech

Trendelenburg Lock Control

Line recommended for environments with medium/high bacteriological hazards, such as clinics, nursing homes, continued care units. Epoxy painted steel frame 60x30x1,5mm. With 4-Section mattress support, three articulated sections and a fixed one, with polymer fibre slats, allowing easy disinfection and reduced bacteriological hazards. Electric actuation of head and foot sections with 2 low tension 6000N motors operated by an easy and intuitive remote control. With 2 accessories supports in the structure. Triumph Head- and foot boards with in-built motors for hi-lo, with 4 100mm wheels, all with brakes.



Option Triumph Mist



Option Trendelenburg and Anti trendelenburg



Option Bed Panel for Triumph
43 CP E T RP N

DIMENSIONS

in cm/kg - tolerance +/-1

TRIUMPH VICTORY

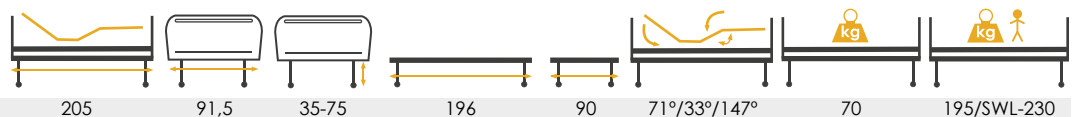

TRIUMPH PLUS ILL



58 CM 1 TP EL RD IL

TRIUMPH PLUS bed - elevator ILL Beech

Electric articulated bed with an epoxy painted steel frame 50x20x2mm, conceived and recommended for environments with reduced bacteriological hazards. With 4-Section mattress support, three articulated sections and a fixed one, with wooden slats. Electric actuation of head and foot sections with a central low tension motor. Triumph Plus Head- and foot boards with hidden in-built motors for hi-lo, with 4 100mm wheels, all with brakes.



Option Trendelenburg



Trendelenburg Lock Control



DIMENSIONS

in cm/kg - tolerance +/-1

TRIUMPH PLUS ILL

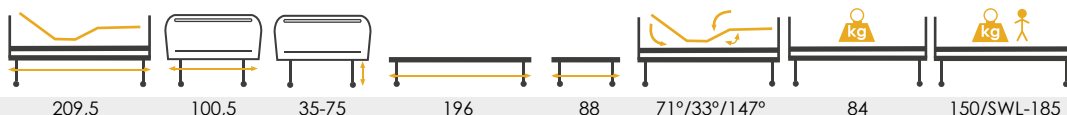

TRIUMPH PLUS MISTERY



58 CM 1 TP EL RD MY GM
TRIUMPH PLUS bed - elevator MIST Beech + Solid side rails

Line recommended for environments with medium/high bacteriological hazards, such as clinics, nursing homes, continued care units. Epoxy painted steel frame 60x30x1,5mm. The frame is made of 2 assembling parts, for ease of transport and storage. With 4-section mattress support, three articulated sections and a fixed one, with polymer fibre slats, allowing easy disinfection and reduced bacteriological hazards. Electric actuation of head and foot sections with 2 low tension 6000N motors operated by an easy and intuitive remote control. Solid wood side rails. With 2 accessories supports in the structure. Triumph Plus Head- and foot boards with hidden in-built motors for hi-lo, with 4 100mm wheels, all with brakes.



Option Trendelenburg



Trendelenburg Lock Control

DIMENSIONS

in cm/kg - tolerance +/-1

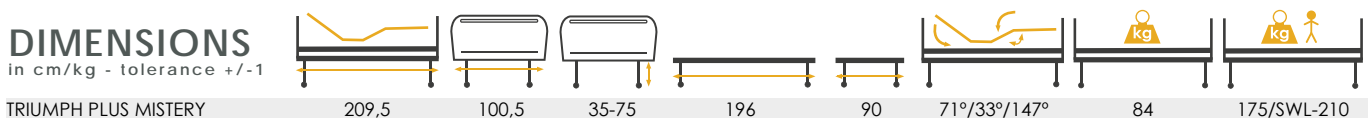

TRIUMPH PLUS MISTERY

DESIRE ILL



Electric articulated bed with an epoxy painted steel frame 50x20x2mm, conceived and recommended for environments with reduced bacteriological hazards. With 4-Section mattress support, three articulated sections and a fixed one, with wooden slats. Electric actuation of head and foot sections with a central low tension motor. Solid wood legs with chipboard and melamine beech head- and foot boards.

58 CM 1 DE EL SR IL

Bed DESIRE-ILL Elet 4PL Beech Mel

DIMENSIONS

in cm/kg - tolerance +/-1

DESIRE ILL

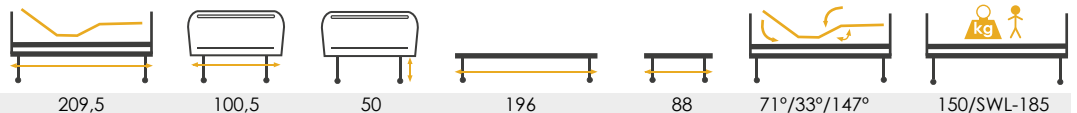

DESIRE PLUS VICT



Line recommended for environments with reduced bacteriological hazards. Epoxy painted steel frame 50x20x2mm. With 4-Section mattress support, three articulated sections and a fixed one, with wooden slats. Electric actuation of head and foot sections with 2 low tension electric motors. Double slat in the fixed section. With 2 accessories supports in the structure. Solid wood legs with chipboard and melamine beech head- and foot boards.

58 CM 1 DE EL SR VT

Bed DESIRE-VICT Elet 4PL

DIMENSIONS

in cm/kg - tolerance +/-1

DESIRE PLUS VICT





58 CM 1 VT EE TS JA AL

VICTORY ALZHEIMER Bed JASMINE

Line recommended for environments with medium/high bacteriological hazards, such as clinics, nursing homes, continued care units. Conceived for people affected with Alzheimer or other autonomy lost related pathologies, risking falling off the bed.

Alzheimer Bed has epoxy painted steel frame 60x30x1,5mm. With 4-Section mattress support, three articulated sections and a fixed one. Its polymer fiber slats enable easy disinfection and reduction of bacteriological hazards. Electric actuation of head and foot sections with 2 low tension 6000N motors operated by an easy and intuitive remote control with safety functions (self contour, retarded action, entrapment protection on head section). Robust and stable elevator, with 125mm wheels, 2 with brakes, ensures robustness and lateral stability is safer for the user as it lowers to 26cm, avoiding injuries in case of fall. Maximum height 75cm to ensure a better positioning and ergonomics for the carers, also enabling easy movement at any intermediate height. With 2 accessories supports in the structure. Jasmine head- and foot boards in MDF (medium density fiberboard) rounded and varnished, beech finishing. Beech solid wood side rails. Options available (ex. Central brakes).

DIMENSIONS

in cm/kg - tolerance +/-1

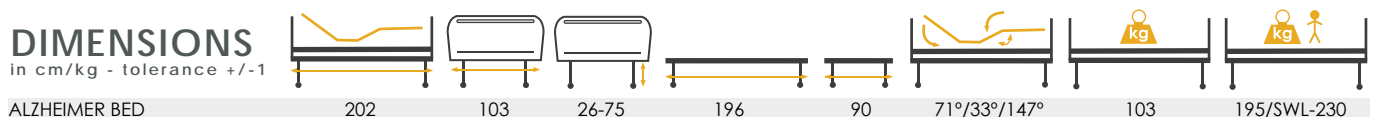

COMPONENTS AND ACCESSORIES

FRAMES



43 SM 3 IL EL

ILLUSION

ILLUSION electric frame 4 sections



43 SM 3 I2 EL

ILLUSION 2 (DETACH. FRAME)

Illusion 2- detachable electric frame 4 sections



43 SM 3 FT EL

FANTASY ELECTRIC

FANTASY electric frame 4 sections



43 SM 3 VT EL

VICTORY ELECTRIC

VICTORY electric frame 4 sections



43 SM 3 VT EL PT

MISTERY ELECTRIC (DETACHABLE FRAME)

MISTERY electric frame 4 sections



43 SM 3 VT EL 105

VICTORY ELECTRIC 105CM

VICTORY electric frame 4 sections
Steel epoxy painted slats



43 SM 3 VT EL 5P

VICTORY ELECTRIC 5 SECTIONS

VICTORY electric frame 5 sections

HI-LO



43 EL 3 GE EL TS

SCISSORS HI-LO

Electric hi-lo with scissors model (100mm casters)



43 EL 3 GE EL 2H

DOUBLE H HI-LO

Electric hi-lo with double h model (125mm casters)



43 EL 3 GE EL 2H CL

DOUBLE H HI-LO WITH CILINDERS

Electric hi-lo with double h model with cilinders



43 EL 3 GE EL TD

DOUBLE H HI-LO WITH TREND. AND REVERSE

Electric hi-lo with double h with trendelenburg and reverse model (125mm casters)

HEAD AND FOOT BOARDS



FINISHINGS

Beech, cherry and wengue



43 CP E F DA

DAISY

DAISY, Melamine Beech (9,6kg)



43 CP E F IR

IRIS

IRIS, Melamine Beech (8,4kg)



43 CP E F VI

VIOLET

VIOLET MDF Beech (10,8kg)



43 CP E F CH CL

CHAMELIA

CHAMELIA With Rails MDF Beech(20,4kg)
Option w/o Rails 43 CP E F CH



43 CP E F JA CL

JASMINE

JASMINE With Rails MDF Beech(20,8kg)
Option w/o rails 43 CP E F JA



43 CP E F OR CL

ORCHIDEA

ORCHIDEA Beech With Rails (14kg)



43 CP E F TU CL

TULIP

TULIP Beech With Rails (13,6kg)



43 CP E F TR EL

TRIUMPH

TRIUMPH Elev Beech Without Rails (35,2kg)



43 CP E F TP EL CL

TRIUMPH PLUS

TRIUMPH PLUS Elev Beech (48,8kg)



43 CP E F DE

DESIRE

DESIRE Orl Melam With or Without Calhas c/ Illarg (25kg)



43 CP 3 F RO

ROSE

ROSE Beech/Steel (10kg)

LEGS



43 PE 3 FX SR
FIXED

Fixed legs 45cm (p/somiers)



43 PE 3 RG AL SR PQ
HEIGHT ADJUSTABLE

Height adjustable legs
37,5/45/52,5cm (p/ Somiers)



43 PE 3 RD AC 100
WITH WHEELS

Legs with wheels 100- 4 castors
2 with brake



43 PE 3 RG AL CR
HEIGHT ADJUS W/WHEELS

Height adjustable legs with
wheels 100- 4 castors 2 with brake

BARANDILLAS Y OTROS ACCESORIOS



43 GR 3 GE
STEEL ORT

Painted Universal Geriatrics Railing ORT



58 GR Y AL EX
OPEN SIDE RAILS

Open side rails with external hooks (universal) 10.56



58 GR 3 AA
UNIVERSAL PAINTED SIDE RAILS

Universal painted side rails APX



43 GR E FM
SOLID BEECH SIDE RAILS

Solid beech side rails to go up and down



43 GR E FM 3B
SOLID BEECH 3 SIDE RAILS

Solid beech side rails to go up and down



58 PD W AP CM
Barra de Apoyo p/Cama

Soporte de Apoya p/ Cama



31 PT W PE
FEET PROTECTION

Feet protection



58 PD 3 PA
INCORPORADOR DE

Incorporador de Pared



58 PD 3 BA
INCORPORADOR

Trapezio con base 10.48



33 PD Y SI
INCORP. ACERO

Bipedestador en acero sencillo para cama



58 AP 9 CT
BACKREST

Backrest suport



33 PD 3 AD IL
Adaptador ILLUSION

Adaptador p/ILLUSION elevador Tijera



43 CP 2 CR
ROUND CORNERS

Round corners (if not using headboard)(4Un)



43 CP 3 FS
CLOSURE

Victory Sommier Closure (If not using headboard) (Pair)

BEDSIDE TABLE



58 ME E CB MD PQ

Mesa Noche 1 Frt+cajón s/Rd MDF Barniz

BEDSIDE TABLE

Dimensions

48x38x60cm

Bedside table with drawer and door (without wheels)

BEDSIDE TABLE



58 ME E CB MD PQ CA

Mesa Noche 1 Frt+cajón s/Rd MDF Barniz with opening

BEDSIDE TABLE

Dimensions

48x38x60cm

Bedside table with drawer, door and an opening space (without wheels)

BEDSIDE TABLE WITH BED TABLE



58 ME 3 CL CB MD RD

Bedside table w/bed table Door+Drawer (MDF)

BIG BEDSIDE TABLE WITH BED TABLE

Dimensions

62x45x103-153cm

Large bedside table with folding bed table extensible and adjustable in height and angle



58 ME 3 CL CB 2F ML

Bedside table 2 Frt Door+Drawer w/bed table - insert (Melam.)

BEDSIDE TABLE WITH TWO FRONTS AND BED TABLE

Dimensions

52x45x87-119cm

Large bedside table with two fronts, folding bed table extensible and adjustable in height and angle

BED TABLE



58 ME 3 CL SP MD
Over bed table - Reclining (Varnish MDF)

BED TABLE

Dimensions

73x43x72-122cm

Large bed table with table for bed adjustable in height and angle



58 ME 3 CL SP ML
Over bed table - Reclining (Melam.)

CHEST



58 CO E MD
Dresser with 4 Drawers 1,1x0,45x0,85m

CHEST WITH 4 DRAWERS

Dimensions

110x45x85cm

MIRROR



58 ES E

Mirror 0,6x0,7x0,02m

MIRROR

Dimensions

60x2x70cm

Mirror with wood frame

TABLE DESK



58 SE E GV

Desk with 2 Drawers 1,10x0,45x0,77m

TABLE DESK WITH 2 DRAWERS

Dimensions

110x45x77cm

Desk with 2 drawers

CLOSET



58 RP E 1P

Closet 1 Door (optional components) 0,6x0,6x1,9m

1 DOOR CLOSET

Dimensions

60x60x190cm

1 door closet with 3 drawers and 1 shelf



58 RP E 2P

Closet 2 Doors (optional components) 1,15x0,6x1,90m

2 DOORS CLOSET

Dimensions

115x60x190cm

2 doors closet with 3 drawers and 3 shelves

LIVING ROOM

COUCHES

OPORTO LIGHT ELECTRIC/MANUAL	Pag 29
OPORTO LIGHT RISE AND RECLINE	Pag 29
EXOTIC ELECTRIC/MANUAL	Pag 30
EXOTIC RISE AND RECLINE	Pag 30
SAVANNAH ELECTRIC/MANUAL	Pag 31
SAVANNAH RISE AND RECLINE	Pag 31
SAVANNAH PLUS ELECTRIC/MANUAL	Pag 32
SAVANNAH RISE AND RECLINE	Pag 32
SIAMÊS	Pag 33
ANGORÁ	Pag 33

pag 29-36

CHAIRS

BOLINÊS 1 SEAT	Pag 34
BOLINÊS RELAX	Pag 34
BOLINÊS 2 SEATS	Pag 35
BOLINÊS 3 SEATS	Pag 35
ACCESSORIES	Pag 35

OTHER FURNITURE

TABLES	Pag 36
SHELVES/SALON FURNITURE	Pag 36

FINISHINGS	Pag 40
------------	--------

ORTHOS Geriatrics' couches are functional and modern in design. They are conceived for the comfort and rest of the user requiring health cares. We display various models, from manual to electric back recline and calf elevation and also rise and recline. WE have models for various purposes, from home use to models conceived for nursing homes or clinics and hospitals. WE use robust structures for different users 'weights and finishings which are suited for the use and aesthetical options. We have standard models and are also able to customize (dimensions, colours and upholstery types, etc.) to attend special needs.

OPORTO LIGHT ELECTRIC/MANUAL

Couch with electric recline for home and nursing home use. Simple and economic line, it makes changing the position for users with motor difficulties practical and easy. OPORTO LIGHT has fix arms, lateral head support and legs support. Legs support rises simultaneously with the progressive back recline. Stable on all positions. Skin-alike upholstery in black and chocolate brown. Also available in manual recline, with or without wheels.



58 SF N OL SR AE .02

OPORTO LIGHT Couch w/wheels w/elect joint (Black) w/o dsc

DIMENSIONS

in cm/kg - tolerance +/-1

OPORTO LIGHT ELECTRIC/MANUAL

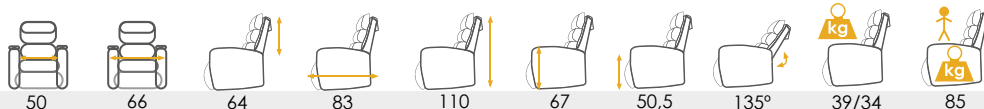

OPORTO LIGHT RISE AND RECLINE

Couch with electric recline for home and nursing home use. Simple and economic line, it makes changing the position for users with motor difficulties practical and easy. OPORTO LIGHT RISE AND RECLINE has fix arms, lateral head support and legs support. Small inner wheels to allow for small displacements to clean the surrounding space. Legs support rises simultaneously with the progressive back recline. Stable on all positions. Skin-alike upholstery in black and chocolate brown. OPORTO LIGHT RISE AND RECLINE allows seat to raise from 0° to some 45° to assist the user when seating and rising.



58 SF N OL SR EL .02

OPORTO LIGHT Couch w/electric lift (Black) 2Castors

DIMENSIONS

in cm/kg - tolerance +/-1

OPORTO LIGHT RISE AND RECLINE

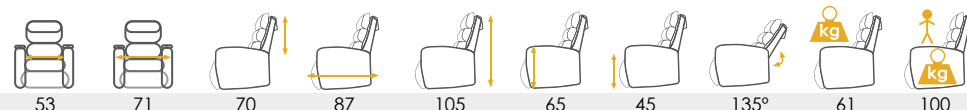

EXOTIC ELECTRIC/MANUAL



Couch with electric recline for home, nursing home and hospital use. With traditional and rounded lines, it is very practical and allows the user with mobility difficulties to easily change position.

EXOTIC has wheels, fix arms, lateral head support, legs support and comfortable seat, with upper memory foam layer. Legs support unfolds, allowing extended leg support and rises simultaneously with the progressive back recline. Stable on all positions. Skin-alike Medical upholstery in black, blue and chocolate brown. Other colours are also available under request. Also available in manual recline, with or without wheels. Available options: without head support and EXOTIC PLUS with removable arms.



58 SF N EX CR AE .01

EXÓTICO Couch w/o wheels w/elect joint (Brown)

DIMENSIONS

in cm/kg - tolerance +/-1

EXOTIC ELECTRIC/MANUAL

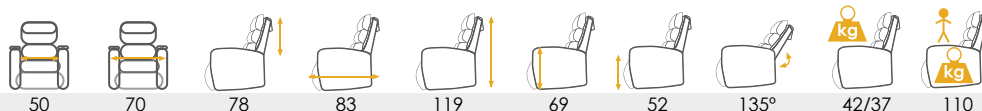

EXOTIC RISE AND RECLINE



Couch with electric recline up to 150°, for home, nursing home and hospital use. With traditional and rounded lines, it is very practical and allows the user with mobility difficulties to easily change position.

EXOTIC RISE AND RECLINE has wheels, fix arms, lateral head support, legs support and comfortable seat, with upper memory foam layer. Legs support unfolds, allowing extended leg support and rises simultaneously with the progressive back recline. Stable on all positions. Skin-alike Medical upholstery in black, blue and chocolate brown. Other colours are also available under request. Also available in manual recline, with or without wheels.

EXOTIC RISE AND RECLINE allows seat to raise from 0° to some 45° to assist the user when seating and rising.



58 SF N EX SR EL .01

EXÓTICO Couch w/electric lift (Brown) 2Castors

DIMENSIONS

in cm/kg - tolerance +/-1

EXOTIC RISE AND RECLINE

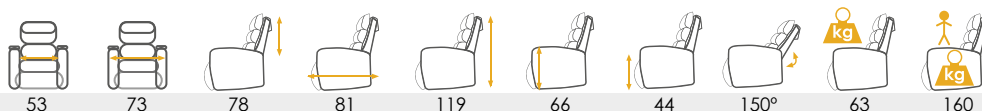

SAVANNAH ELECTRIC/MANUAL

Extra-comfortable couch with electric recline for home, nursing home and hospital use. With contemporary lines, it is very practical and easy for the user with mobility difficulties to easily change position. Besides, its silicon fibers filling helps the prevention of decubitus (bedsores). SAVANNAH Electric has wheels, its legs support is integrated with the seat with silicon fibers filling, all combined to provide maximum comfort. Legs support rises simultaneously with the progressive back recline. Stable on all positions. Skin alike Rainbow upholstery for the structure, with bacteria and fungus protection treatment and Suede-like, smooth and breathable for the cushions. EN 1021-1:2006 fire protection standards. Available in brown, beige and grey. The seat and back cushions are removable and washable. Also available in manual recline, with or without wheels.



58 SF N SV CR MN .03

SAVANNAH Couch w/wheels - Man (Grey)

DIMENSIONS

in cm/kg - tolerance +/-1

SAVANNAH ELECTRIC/MANUAL

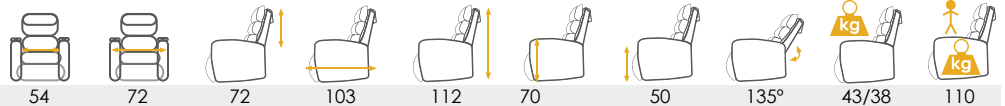

SAVANNAH RISE AND RECLINE

Extra-comfortable couch with electric recline for home, nursing home and hospital use. With contemporary lines, it is very practical and easy for the user with mobility difficulties to easily change position. Besides, its silicon fibers filling helps the prevention of decubitus (bedsores). SAVANNAH RISE AND RECLINE has its legs support integrated with the seat with silicon fibers filling, all combined to provide maximum comfort. Legs support rises simultaneously with the progressive back recline. Stable on all positions. Skin alike Rainbow upholstery for the structure, with bacteria and fungus protection treatment and Suede-like, smooth and breathable for the cushions. EN 1021-1:2006 fire protection standards. Available in brown, beige and grey. The seat and back cushions are removable and washable. SAVANNAH RISE AND RECLINE allows seat to raise from 0° to some 45° to assist the user when seating and rising.

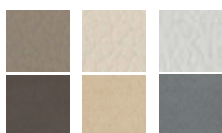

58 SF N SV SR EL .03

SAVANNAH Couch w/electric lift (Grey) 2Castors

DIMENSIONS

in cm/kg - tolerance +/-1

SAVANNAH RISEAND RECLINE

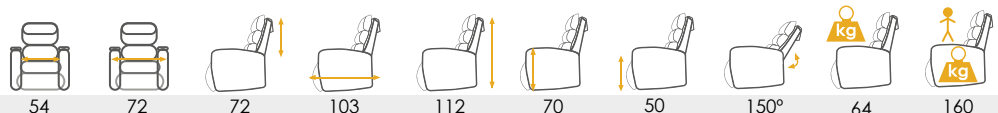

SAVANNAH PLUS ELECTRIC/MANUAL



Extra-comfortable couch with electric recline for home, nursing home and hospital use. With contemporary lines, it is very practical and easy for the user with mobility difficulties to easily change position. Besides, its silicon fibers filling helps the prevention of decubitus (bedsores). Easily detachable arm rests to ease the transfer, covered in easily removable cushions which, besides allowing maximum comfort, also enable the reduction of the seat's width for thinner persons. SAVANNAH PLUS Electric has wheels, its legs support is integrated with the seat with silicon fibers filling, all combined to provide maximum comfort. Legs support rises simultaneously with the progressive back recline. Stable on all positions. Skin alike Rainbow upholstery for the structure, with bacteria and fungus protection treatment and Suede-like, smooth and breathable for the cushions. EN 1021-1:2006 fire protection standards. Available in brown, beige and grey. The seat, back and armrest cushions are removable and washable. Also available in manual recline, with or without wheels.

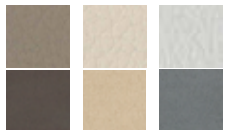

58 SF N SVP SR MN .10
Sofá SAVANNAH PLUS s/Rd Man (Beige)

DIMENSIONS

in cm/kg - tolerance +/-1

SAVANNAH PLUS ELECTRIC/MANUAL

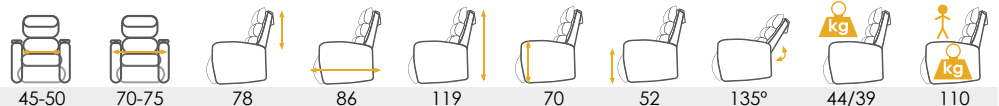

SAVANNAH RISE AND RECLINE



Extra-comfortable couch with electric recline for home, nursing home and hospital use. With contemporary lines, it is very practical and easy for the user with mobility difficulties to easily change position. Besides, its silicon fibers filling helps the prevention of decubitus (bedsores). Easily detachable arm rests to ease the transfer, covered in easily removable cushions which, besides allowing maximum comfort, also enable the reduction of the seat's width for thinner persons. SAVANNAH PLUS RISE AND RECLINE has detachable armrests, its legs support is integrated with the seat and small inner casters to allow for cleaning in the surrounding space. Legs support rises simultaneously with the progressive back recline. Stable on all positions. Skin alike Rainbow upholstery for the structure, with bacteria and fungus protection treatment and Suede-like, smooth and breathable for the cushions. EN 1021-1:2006 fire protection standards. Available in brown, beige and grey. The seat, back and armrest cushions are removable and washable. SAVANNAH PLUS RISE AND RECLINE allows seat to raise from 0° to some 45° to assist the user when seating and rising.

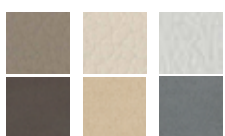

58 SF N SVP SR EL .10
SAVANNAH PLUS Couch w/electric lift (Beige) 2Castors

DIMENSIONS

in cm/kg - tolerance +/-1

SAVANNAH RISE AND RECLINE

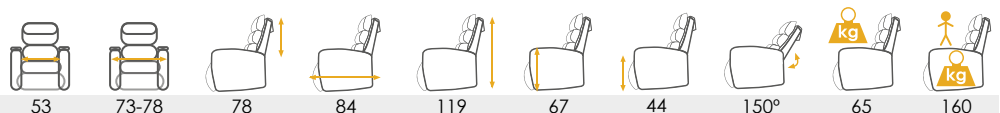

Multifunctional comfort couch which transforms into a bed. Steel structure with hi resistance foam. Skin alike upholstery with a wide range of colours available.

SIAMÈS

Longitud del colchon

190

Longitud total de la cama

226



58 SF 2 SI .99

SIAMES Bed couch

DIMENSIONS

in cm/kg - tolerance +/-1

SIAMES



76



45



50



90



97

ANGORÁ

Angorá couch with steel structure and high resistance foam. Resistant and light weight. Skin alike upholstery with a wide range of colours available.
Dimensions H(98)xW(61)xD(51)cm.



58 SF 6 AG

ANGORÁ couch

DIMENSIONS

in cm/kg - tolerance +/-1

ANGORÁ



61



51



98

Bolinês couchés and other geriatric furniture combine the functionality and comfort with a modern and elegant design. They are conceived for the user needing health cares, particularly in nursing homes or day care centers. Our Bolinês, in various models and finishing, use first quality solid beech. The arms provide strong support for the user, they are long and ample for his/her comfort, with rounded corners to avoid injuries. The seats are ergonomic, skin alike upholstery with anti-bacteria treatment and high-density foams, for intensive use. The furniture is made of first quality solid beech wood. We have standard models and are also able to customize (dimensions, colours and types of wood, upholstery, etc.).

BOLINÊS 1 SEAT



58 CD E BO 1L
BOLINES Couch 1 Seater Medium Back

BOLINÊS 1 SEAT MEDIUM BACKREST

Dimensions

62x70x95cm

Butaca de respaldo medio. Apoyabrazos recto, asiento y respaldo tapizados



58 CD E BO 1L CA
BOLINES Couch 1 Seater High Back

BOLINÊS 1 SEAT HIGH BACKREST

Dimensions

65x70x119cm

High backrest armchair. Straight armrests, seat and back in upholstery

BOLINÊS RELAX



58 CD E BO 1L + 58 Z9 PU RD RP
BOLINES Couch 1 Seater Medium Back + wheels, footrest and handles

BOLINÊS 1 SEAT MEDIUM BACKREST

Dimensions

62x70x95cm

High backrest armchair with accesories to enable transfer (wheels, footrest and handles)



58 CD E BO RE CR
BOLINES Couch Relax High Recl Back Feetrest CD28 - C

BOLINÊS 1 SEAT HIGH BACKREST

Dimensions

65x70x119cm

Reclinable high backrest armchair with elevating legrest

BOLINÊS 2 SEATS



58 CD E BO 2L
BOLINES Couch 2 Seater Medium Back

BOLINÊS 3 SEATS



58 CD E BO 3L CA
BOLINES Couch 3 Seater High Back

BOLINÊS 2 SEATS MEDIUM BACKREST

Dimensions
113x70x95cm
2 seats armchair with independent medium backrests

BOLINÊS 3 SEATS HIGH BACKREST

Dimensions
193x70x119cm
3 seats armchair with independent highrests

ACCESSORIES



58 Z9 E CE SP
Head Rest with Ear Support

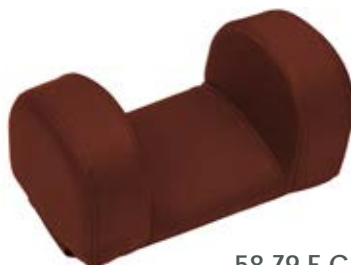

58 Z9 E CE AB
Head Rest with Ear Support



58 Z9 AP E LB
Lumbar Support

SIMPLE HEADREST

Simple headrest

HEADREST

Headrest with tabs

LUMBAR SUPPORT

Pair of lumbar supports



58 BC E AT
Swinging Feet Rest in Solid Faia and Upholstered

ARTICULATED FEET SUPPORT

Dimensions
45x40x40cm
Articulated feet support for couches

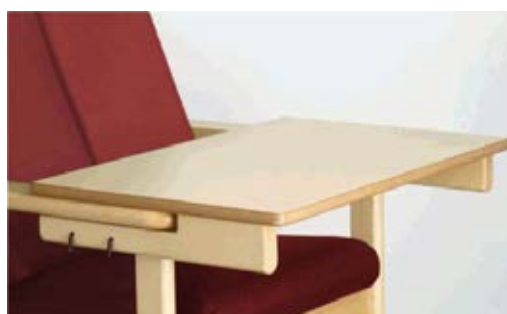

58 Z9 TB E
Wood Tray - Adjustable to Couches' Arms

TRAY

Wood tray for armchairs

TABLES



58 ME E AP RT
Rectangular Table 1,2x0,9x0,75m RC4



58 ME E AP QD
Square Table 0,9x0,9m



58 ME E JG
Game Table 0,9x0,9

RECTANGULAR TABLE

Dimensions
100x60x60cm
Rectangular table

SQUARE TABLE

Dimensions
60x60x60cm
Square table

GAMBLING TABLE

Dimensions
80x80x75cm
Gambling table with reversible top

SHELVES/SALON FURNITURE



58 ET E 4P
Bookcase for matasines 0,8x0,4x2,0m ACC7



58 VT E 2P
Showcase 0,8x0,4x2,0m ACC5



58 MV E TV
TV Closet 0,95x0,45x0,85m ACC12

MAGASINES SHELVES

Dimensions
84x40x205cm
Magazines shelves made of 4 inclined shelves

SHOWCASE

Dimensions
84x40x205cm
Cabinet with two top glass doors, two shelves and two lower doors

TV CABINET

Dimensions
95x45x85cm
TV cabinet with space for Video-DVD, with two drawers and two lower doors.

DINNING ROOM

COMEDOR

SIMPLE CHAIR

Pag 38

COMFORT CHAIR

Pag 38

DINING TABLE

Pag 39

SIDEBOARD

Pag 39

FINISHINGS

Pag 40

ORTHOS Geriatrics chairs and dining room furniture combine functionality and comfort with a modern and elegant design. They are conceived for the user needing health cares, particularly in nursing homes or day care centers. Our chairs, in various models and finishing, use first quality solid beech. The arms provide strong support for the user, they are long and ample for his/her comfort, with rounded corners to avoid injuries. The seats are ergonomic, skin alike upholstery with anti-bacteria treatment and high-density foams, for intensive use. The furniture is made of first quality solid beech wood. We have standard models and are also able to customize (dimensions, colours and types of wood, upholstery, etc.).

SIMPLE CHAIR



58 CD E SP SB

Chair - Upholstered Seat and Back without Arms

SIMPLE CHAIR WITHOUT ARMS

Dimensions

59x53x81 cm

Chair without armrests. Model with seat and backrest in upholstery. Chair with ergonomic design.



58 CD E SP CB

Chair - Upholstered Seat and Back with Arms

SIMPLE CHAIR WITH ARMS

Dimensions

59x53x81 cm

Chair with armrests. Model with seat and backrest in upholstery. Chair with ergonomic design.

SIMPLE CHAIR



58 CD E SP SB EM

Simple chair without arms wood back

SIMPLE CHAIR WITHOUT ARMRESTS

Dimensions

52x50x75cm

Chair without arms. Model with seat in upholstery.

COMFORT CHAIR



58 CD E CF

COMFORT Chair

COMFORT CHAIR

Dimensions

59x51x87cm

Chair with armrests. Model with seat and backrest in upholstery. Wood structure. Stackable.

DINING TABLES



58 ME E RF RD
Round Table 1,2m



58 ME E RF QD
Square Table 0,9x0,9m



58 ME E RF RT
Rectangular Table 1,2x0,9x0,75m RC4

ROUND DINING TABLE

Dimensions
75cm Ø120
Round dining table

SQUARE DINING TABLE

Dimensions
90x90x75cm
Square dining table

RECTANGULAR DINING TABLE

Dimensions
120x90x75cm
Rectangular dining table

SIDEBOARD



58 AP E VI
Sideboard+Showcase 3 glass Doors 1,37x0,5x1,9m



58 AP E
Sideboard 3sect with 3 Doors Drawers 1,37x0,5x0,86m

SIDEBOARD AND SHOW CASE

Dimensions
137x50x190cm
Sideboard made of an upper module with 3 doors and 2 shelves. Lower module with 3 drawers and 3 doors.

SIDEBOARD

Dimensions
137x50x86cm
Sideboard with 3 drawers and 3 doors

FINISHINGS

MEDICAL

Medical skin alike fabric, with antibacterial treatment and flame protection as per EN 1021-1:2006/ EN 1021-2:2006, displays exceptional abrasion resistance (> 100k Martindale cycles). REACH Certified.



RAINBOW

Antibacterial and antifungus treatment, salted and chlorinated water resistant, resistant to UV light (grade 7) and exceptional abrasion resistance (> 100k Martindale cycles). Flame protection as per EN 1021-1:2006/ EN 1021-2:2006, displays REACH Certified.



SUEDE

For Savannah models (centre upholstery). Suede look alike fabric with soft touch. Easy to clean (washable at 40°), this fabric is breathable and will keep its original look. Good abrasion resistance (> 40k Martindale cycles). Flame protection as per EN 1021-1:2006. REACH Certified.



STANDARD- BEECH

BEECH COLOR CHERRY

BEECH COLOR WENGUE

Note. We waive responsibility for migration problems related to the quality of chemicals. We also waive any responsibility for non compliance with use, cleaning, and maintenance instructions.

PILLS ORGANIZERS

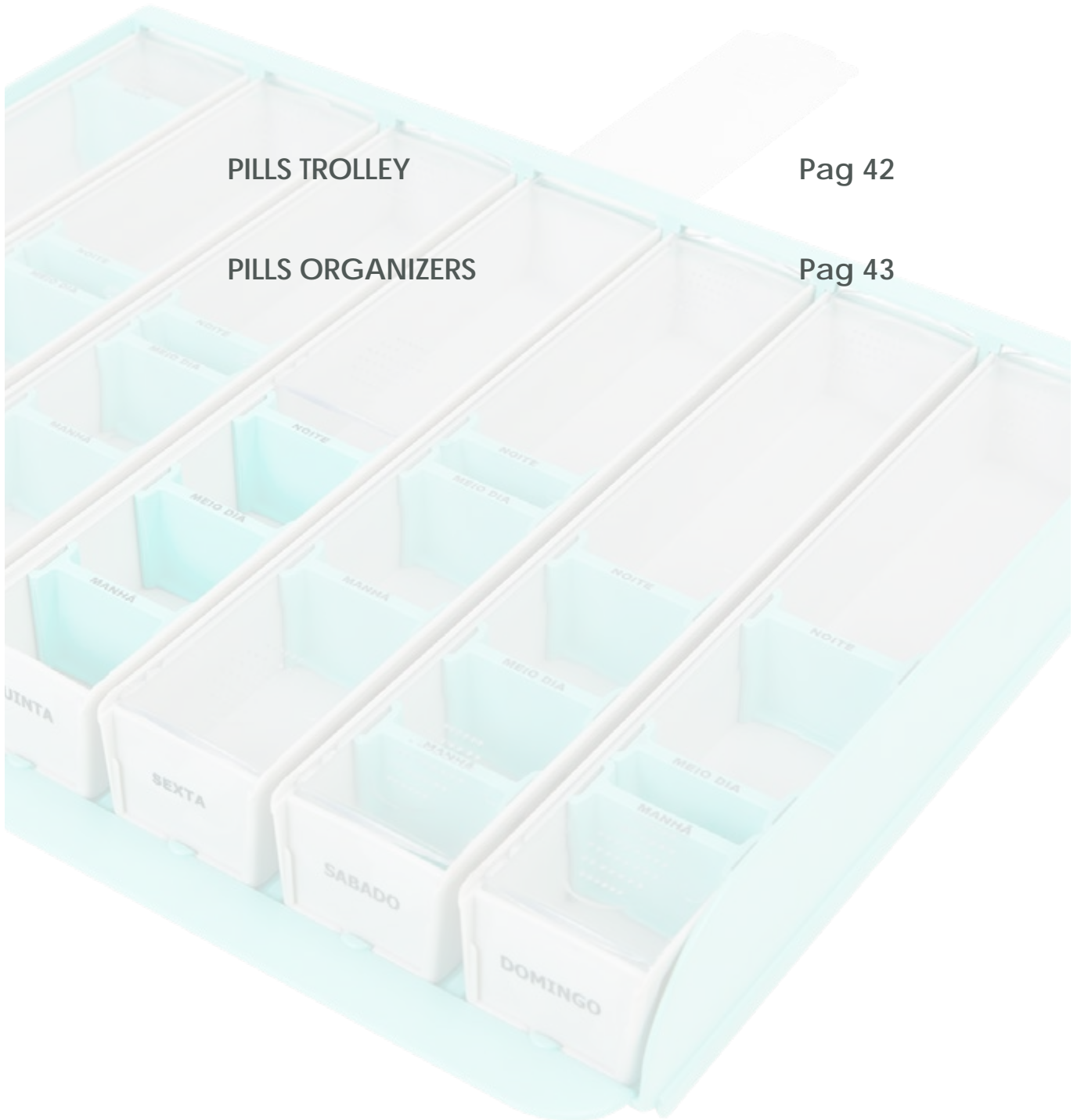

PILLS TROLLEY

Pag 42

PILLS ORGANIZERS

Pag 43

PILLS TROLLEY



65 CR CM 60
Trolley for 60 trays



65 CR CM 30
Trolley for 30 trays

Pills trolley with capacity for 15, 30, 60 and 90 trays. Inner robust structure in steel. External panels, base and top surface in phenolic resin. With exception of the 15 trays trolley, all the others have two access fronts. 4 100mm double casters with brakes. Lockable doors for enhanced safety and protection. It allows weekly medication trays with 7 removable and height adjustable modules. The trays are not included.



TRAY

65 BD 5C P7 M4 T
Complete tray with 7 modules, 4 daily takes
Dimensions:
41,5x33,5x5,7cm



TRAY

65 BD CP BL P3
Complete tray with 7 modules, 4 daily takes - BLP 3100
Dimensions:
32x20x4cm

PILLS ORGANIZERS



65 CT
Pill cutter blue/red - CR 220



65 CT TR
Cutter grinder white - CR 210

PILL CUTTER

Blue, red

CUTTER GRINDER WHITE

Cutter grinder white - CR 210



65 CX PR CH
Pills box with door key



65 CX PR C4
Daily pills box with four compartments- PR C4



65 CX MD 1T
Weekly pills box 1 daily dose S1

PILLS BOX

Pills box with door key

DAILY PILLS BOX

Daily pills box with four compartments

WEEKLY PILLS BOX

Weekly pills box 1 daily dose



65 CX MD 1T A
Weekly box 1 daily dose with alarm A1



65 CX MD 3T
Weekly pills box with 3 daily doses S3



65 CX MD 3T G
Big weekly pills box with 3 daily doses Sg3

WEEKLY BOX WITH ALARM

Weekly box 1 daily dose with alarm

WEEKLY PILLS BOX

Weekly pills box with 3 daily doses

BIG WEEKLY PILLS BOX

Big weekly pills box with 3 daily doses



65 CX MD 4T
Weekly pills box with 4 daily doses Sp4



65 CX MD 4T AG
Big weekly pills box in calendar format gr Ag-Sag4

WEEKLY PILLS BOX 4 DOSES

Weekly pills box with 4 daily doses Sp4

BIG WEEKLY PILLS BOX

Big weekly pills box in calendar format with 4 daily doses

DAILY LIFE HELPERS

DAILY LIFE HELPERS TO EAT

Pag 45

DAILY LIFE HELPERS TO DRESS

Pag 46

OTHER DAILY LIFE HELPERS

Pag 46



DAILY LIFE HELPERS TO EAT



67 UT RB PR. 06
Plate Surround (Red)

PLATE SURROUND

Fixed on a flat plate by placing the three hooks around the edge of the plate



67 UT BA MD SD
Buttering Board 15x15cm- 145045

BUTTERING BOARD

On two sides of the plate there are six one cm high pegs to help hold the sandwich in place 15x15cm



67 UT CO PO. 06
Drinking Cup (Red)

DRINKING CUP

This drinking cup has a long mouthpiece which makes drinking become easier and prevent from spilling out the liquid



67 UT PS

SCOOP DISH

The height back on the scoop dish accommodates individuals who have difficulty when eating particularly with one handed



67 UT PS GR

LARGE SCOOP BOWL

The large mould side to this scoop accommodates individuals who have difficulty when eating particularly with one handed



67 UT CL CH

BENDABLE TEASPOON

The bendable teaspoon with the built-up cushion grip handle is comfortable to hold and improves grip



67 UT FC

ROCKER KNIFE

The rocker knife has a soft cushion grip handle that is comfortable and easy to hold



67 UT GF

BENDABLE FORK

The bendable fork with the built-up cushion griphandle is comfortable to hold and improves grip



67 UT CL

BENDABLE SPOON

The bendable spoon with the built-up cushion grip handle is comfortable to hold and improves grip



67 UT MA

STANDARD MULTI OPENER

Can be used to open pressure caps, resalable twist-off bottle caps, ring pull cans and jar lids



67 UT AF

NON-SLIP JAR

Bottle Opener

DAILY LIFE HELPERS TO DRESS



67 UT CC

PANTYHOSE AID

The Pantyhose Aid is to compensate for a disability by helping a person put on socks or stocking without bending at the waist or hips



67 UT CM

SOCK AID

The Stock Aid is to compensate for a disability by helping a person put on socks or stocking without bending at the waist or hips



67 UT AB FH

BUTTON HOOK / ZIPPER PULL

This special device makes managing buttons and zippers easier



67 UT CL SP

SHOEHORN

The Shoehorn is designed to help put on shoes without bending down - 145157

OTHER DAILY LIFE HELPERS



67 UT AG

EYE DROP GUIDE

Ideal for people who have difficulty to control their hand stable



67 UT PE OB AT DB 65

ACTIVE GRABBER

Foldable active grabber 65cm - 1626



67 UT CH 3

KEYRING FOR 3 KEYS

Keyring for 3 Keys



67 UT SP GC

UMBRELLA HOLDER

For use on transit or self propelled wheelchairs



67 UT SP LV

Soporte Madera para Lectura - 145418

BOOK SUPPORT

Book support in wood

ENVIRONMENT



MODULARITY



DURABILITY

Orthos Geriatrics
focuses on the
prevention of infections.
Have you thought of
the bacteriological
hazards, cleanliness,
d e s i n f e c t i o n
a n d s m e l l . . .

ORTHOS XXI, Unipessoal Lda.
Rua de Santa Leocádia | 4809-012 Santa Leocádia de Briteiros
Guimarães | Portugal
Phone: (+351) 253 470 276/ 77/ 70
E-mail: sofia.martins@orthosxxi.com
margarida.silva@orthosxxi.com
Fax: (+351) 253 470 278
info@orthosxxi.com

www.orthosxxi.com

by

ORTHOS
xxi
e u r o p e a n
i n c l u s i v e s o l u t i o n s

ORT HOS

inclusive solutions
BATH & CLEAN

BATH

Durability
Design
Comfort



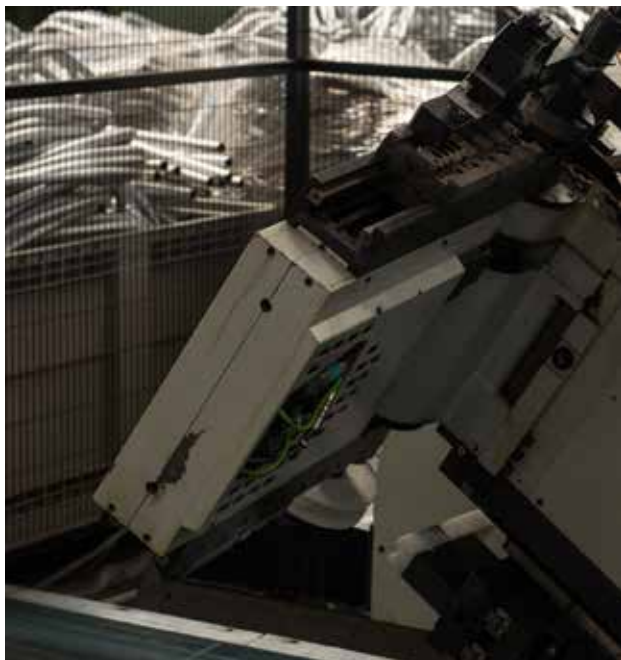

VALUES

We are driven by the conviction that, with our work, we contribute daily to improve the quality of life and to satisfy the needs of the users of our products and services. We prioritize an attitude of teamwork, flexibility and continuous improvement. We consider fundamental a constant investment in innovation and development of the products, currently counting on a team dedicated exclusively to this purpose.

These values support the presentation, in this new catalog, of some of the most recently developed novelties and, at the same time, to respond to the personalized needs of the users.

HISTORY

Orthos XXI originated from Conrado Dias Lda., a company founded in 1975 in Porto, Portugal.

In 1985, with great support from the owners Mr. Dias and Mrs. Marília, that the Mr. Ribeiro and Mrs. Zilda, decide to give continuity to the business of production and commercialization of walking aids, with the name of Ortomaia, thus concretizing an old aspiration of the Sñr. Ribeiro owning a business. This new company has the assiduous collaboration of Manuel and Luisa and with the timely help of their other children, thus naturally involving the whole family in the process. The bases that make up the current dynamic of Orthos XXI were launched, based on values of affection and proximity among all generations of collaborators.

Together with the production activity, the distribution of products from national and international companies of great importance in the Sector is included in its portfolio.

In 1989, a wheelchair production unit was acquired and integrated, giving rise to two independent and distinct production units, but with joint commercialization.

In 1996 it was necessary to expand, integrate and fully optimize the business, so it was built in Guimarães, a new warehouse with twice the area to accommodate all the aspects of the business. With a view to the expansion and evolution of the activity, in 2007 Several decisive steps are taken:

A process of professionalization of management begins by separating the shareholder structure from the management structure, thus formally creating Orthos XXI.

A production unit for Geriatric and Hospital beds was installed and the facilities for the double were expanded again.

Direct participation in the Spanish market began, creating a commercial structure, OrthosMaia XXI, in Spain.

They initiate and develop several commercial actions to expand and develop new markets and new businesses.

In 2012, a consolidation and product development department was created, which, together with the continuous improvement of the Organization, has allowed the product range to be substantially expanded.

In 2017/18 Orthos XXI, reformulates its marketing and commercial strategy, organizing its product portfolio in ten brands.

We have a base with a productive DNA that allows us to continue production in Europe and a brand-oriented trade strategy to be able to face the competition of multinationals and Asian importers.

QUALITY

The quality of the ORTHOS XXI products can be confirmed in the best hospitals and institutions, where they have chosen us. Most of our products are class I medical devices and bear the CE mark, according to the Community Directives 93/42 / CEE and 2007/47 / CE and are registered in the competent Authority, Infarmed. They are tested by accredited and independent entities, such as the IBV (Institute of Biomechanics of Valencia, in Spain). The company is also certified according to the EN ISO 9001 standard.

The value and qualification of human resources through the implementation of activity is training and updating in different areas have been strong bets of our company. ORTHOS XXI's main concern is the continuous improvement of production processes and services, as well as the improvement of the quality of its products, which allows us to better meet the needs and requirements of customers and users.



BATH AND TOILET ALUMINIUM CHAIRS

Indian, Pacific and Atlantic

pág 6-7

BATH AND TOILET INOX CHAIRS

Arctic, Antarctic and Baltic

pág 9-10

BATH LIFT

pág 11

BATH AND SHOWER SEATS

Revolving, Suspended, Adjustable, Without backrest, With backrest, Wall and Toilet Seat Raiser

pág 13-15

OTHER AIDS

Bedpans, Head Washer, Brush, Bidet, Bath aids and Portable Bath

pág 17-18



BATH AND TOILET ALUMINIUM CHAIRS

pág 6-7



INDIAN



INDIAN, with anodised aluminium structure, anti-corrosion, displays high resistance and durability. With resistant blue ABS sanitary seat. May be used directly or with bucket. Easy to clean. Height adjustable. Also available only structure, without seat, can be used as an alternative to the toilet seat raiser.



54 CD X IN 46 ZZ

INDIAN 46 Adjustable in Height 46 ABS

MEASUREMENTS

in cm / kg - tolerance +/- 1

INDIAN

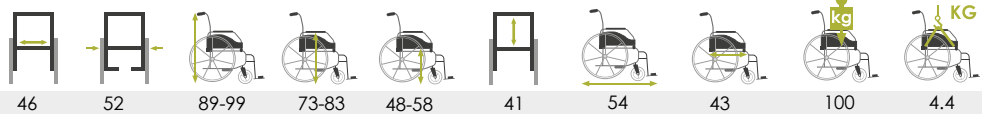

PACIFIC



PACIFIC, with anodised aluminium structure, anti-corrosion, displays high resistance and durability. With comfortable anatomic integral skin seat with wedge format cover. Also available blue ABS sanitary seat. May be used directly or with bucket. Easy to clean.

Two models available:

- With 4 Ø100mm castors , 2 with brakes
- Height adjustable, without brakes



54 CD X PC 46 RR

PACIFIC 4 wheels 46 Integral Skin blue

MEASUREMENTS

in cm / kg - tolerance +/- 1

PACIFIC 4 WHEELS

PACIFIC FIXED

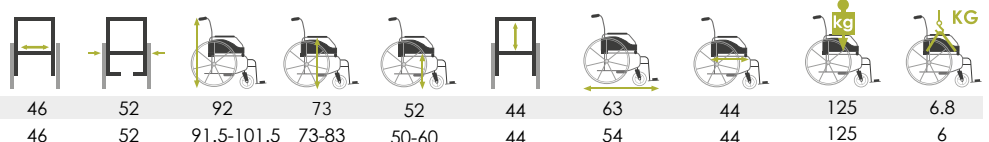

ATLANTIC, with anodised aluminium structure, anti-corrosion, displays high resistance and durability. With folding armrests and detachable footrests. With comfortable anatomic integral skin seat with wedge format cover. Also available blue ABS sanitary seat. May be used directly or with bucket. Easy to clean.

Two models available:

-With four 100mm castors, 2 with brake; with two 600mm wheels and two 100mm castors. Also available narrow version, with narrow armrests.



54 CD X AT 46 RG ABS
ATLANTIC Wheel 600mm 46 ABS



54 CD X AT 46 RR
ATLANTIC 4 wheels 46 Integral Skin blue



Folding armrest



Removable



Parking break



ABS seat



Full-length seat skin



Bilateral footrest

MEASUREMENTS

in cm / kg - tolerance +/- 1

ATLANTIC RUEDA 600mm
ATLANTIC 4 RODEZNOS

	46	70	91	72	53	44	106	85	44	125	14.6
ATLANTIC RUEDA 600mm	46	70	91	72	53	44	106	85	44	125	14.6
ATLANTIC 4 RODEZNOS	46	57	91	72	53	44	81	60	44	125	10

BATH AND TOILET INOX CHAIRS



pág 9-10

ARCTIC

Pág 9

ANTARCTIC

Pág 10

BALTIC

Pág 10



ARCTIC is a foldable bath and toilet wheelchair, with stainless steel structure, anti-corrosion, displays high resistance and durability for multi-users. With folding armrests and detachable footrests. With comfortable anatomic integral skin seat with wedge format cover. Also available blue ABS sanitary seat. May be used directly or with bucket. Easy to clean. Two models available:

- With two 125mm castors and 600mm wheels with brake or with four 125mm castors (two with brakes).



54 CD I AR 46 RG
ARCTIC Wheels 600mm 46



54 CD I AR 46 RR
ARCTIC 4 Wheels 46



Folding armrest



Wheels with brakes



Folding



Full-length seat skin



Bilateral footrest



Notable cube

MEASUREMENTS

in cm / kg - tolerance +/- 1

ARCTIC WHEEL 600mm	46	69	33	90	22	52	37	102	82	44	100	18
ARCTIC 4 WHEELS	46	56	21	90	22	52	37	86	66	44	100	14

ANTARCTIC



54 CD I AN 46 RR FN
ANTARCTIC Inox 46-4 Brake wheels Fenolic seat

ANTARCTIC is a fixed bath and toilet wheelchair, with high resistance stainless steel structure, anti-corrosion, displays high resistance and durability for multi-users. Its bacteriologically immune materials make it suitable for hospital use. With two types of sanitary seat available: seat in phenolic resin with anterior opening in wedge, with backrest in phenolic resin; or seat in ABS, with front or rear opening, with backrest in waterproof upholstery. With folding armrests and detachable footrests. May be used directly or with bucket. Compact and easy for carry the user. Easy to clean and disinfect.



54 CD I AN 46 RR ABS
ANTARCTIC Inox 46-4 wheels ABS

MEASUREMENTS

in cm / kg - tolerance +/- 1

ANTARCTIC ABS	46	56	95	23	54	39	94	74	44	125	14
ANTARCTIC PHENOLIC	46	58	95	26	50.5	41.5	94	74	44	150	16

BALTIC



54 CD I BL 46 RR
BALTIC-Reclin Inox 46-Ast Anatom I SKIN

BALTIC is the new bathroom and sanitary chair with tilting system, easy to act by the caregiver and promoter of comfort and safety for the user. Sturdy stainless steel frame, anti-corrosion and high durability. Networkable detachable backrest. Anatomical seat in integral skin, with opening and wedge. Adjustable headrest height, depth and inclination. Tilt through stainless steel gas spring. Seat height adjustable at 10cm for easy transfers. Folding armrests and removable footrests. With 4 wheels of 125mm, with brake.



Tipping

MEASUREMENTS

in cm / kg - tolerance +/- 1

BALTIC	46	57	96	73	52.5	45	96	75	44	0-35°	125	18.2

BATH LIFT

BATHLIFT



54 EL 9 BH BT

Battery-to-battery Lift

The elevator works with lithium-ion battery located in the hand control. The hand control itself can float in the water. The drive motor and control electronics are completely waterproof, so you can use even with the shower on. The seat can be raised or lowered from 8 to 48cm height.

The drive unit with integrated backrest can be folded down for removal and automatically locks in to the seat base when the lift is raised.

This prevents unintentional tilting of the backrest. Intelligent power control ensures that the lift can only be lowered if sufficient power is available to raise it again.

Easy to transport and storage – and ideally suited for use in the home or away.



MEASUREMENTS

in cm / kg - tolerance +/- 1

BATH LIFT



98.5



72.5



40



50



48-80



65



35-36



5-45°



9.6



140

BATH AND SHOWER SEATS

pág 13-15

REVOLVING

Pág 13

SUSPENDED

Pág 14

ADJUSTABLE

Pág 14

WITH BACKREST

Pág 15

WITHOUT BACKREST

Pág 15

WALL

Pág 15

TOILET SEAT RAISER

Pág 15



54 BC I BA GI S/M
Swivel Bath Seat S / M

Stainless steel structure with white finishing. All materials are anti-oxidizing. Horseshoe format seat and backrest made in green thermoplastified polyethylene. 360° revolving. With safety handle. Recommended for baths with inner upper width between 50 and 66cm, depending the size model.

REVOLVING

Sizes

S, M, L

For bathtubs with interior width
50-55cm / 55-60cm / 60-66cm



MEASUREMENTS

in cm / kg - tolerance +/- 1

GIRATORY S	42	70	50	10	18	51.5	46	37	125	6.6
GIRATORY M	42	73	53	10	18	51.5	46	37	125	6.8
GIRATORY L	42	76	56	10	18	51.5	46	37	125	7

SUSPENDED



Stainless steel structure with white finishing and aluminium. All materials are anti-oxidizing. Horseshoe format seat and backrest made in green thermoplastified polyethylene. With safety handle. Recommended for baths with inner width between 55 and 63cm.

54 BC I BA SP
Bathtub Seat Suspended

MEASUREMENTS

in cm / kg - tolerance +/- 1

SUSPENDED

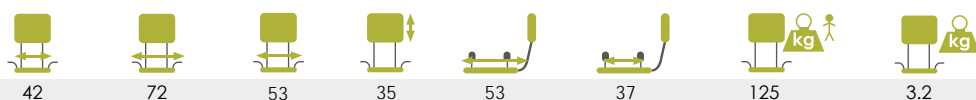

ADJUSTABLE



54 BC XB ABS
Adjustable Bath Seat

Aluminium horseshoe seat in green thermoplastified polyethylene adapts to the bath offering the user a safe and versatile seat.

MEASUREMENTS

in cm / kg - tolerance +/- 1

ADJUSTABLE

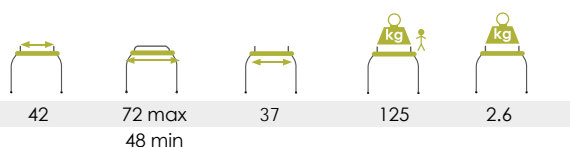

WITH BACKREST



54 BC X PO CC
Simple Shower Seat with Backrest

Shower seat in aluminium. Horseshoe format seat and backrest with green thermoplastified polyethylene. Height adjustable.

MEASUREMENTS

in cm / kg - tolerance +/- 1

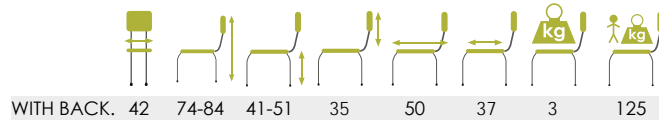

WITHOUT BACKREST



54 BC X PO SP
Simple Shower Seat without Backrest

Shower seat in aluminium. Horseshoe format seat with green thermoplastified polyethylene. Height adjustable.

MEASUREMENTS

in cm / kg - tolerance +/- 1

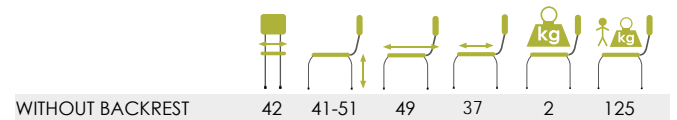

WALL



54 BC I PO PR CC
Shower Bench Wall with Backrest

Stainless steel shower chair for fixing to the wall. Folding for shower without disturbance for other users. Seat in green thermoplastic polyethylene.

MEASUREMENTS

in cm / kg - tolerance +/- 1



TOILET SEAT RAISER



54 AL SN AJ
Elevador Toilet seat 12cm, Ajust. with arms

Toilet seat raiser adjustable with removable armrests. Thermoplastic, adaptable to any toilet.

OTHER AIDS

BEDPANS

Pág 17

HEAD WASHER

Pág 17

pág 17-18

BRUSH

Pág 17

BIDET

Pág 17

BATH AIDS

Pág 17

PORTABLE BATH

Pág 18

BEDPANS



69 UR HM

Male bedpan (with lid)



69 UR MH

Female bedpan



69 AP 9 CUT

Bedpan with lid



69 AP I CU

Wedge Bedpan



69 AP FE

Female Bedpan



69 AP I BD

Wedge Bedpan

HEAD WASHER



54 DB LC IS

Inflatable Tray for Washing Head

Made in very resistant vinyl, with easily inflatable rings and an opening for the head. Ideal for using in bed. Dimensions: 660x585mm



54 DB LC RG

Rigid Tray for Washing Head

Padded flaps hold steadily on the shoulders, and the concave edge placed on the back of patient's neck. Ideal for wheelchair user.

BRUSH



67 UT ES DH

Ut Brush for Shower



67 UT ES CB

Ut Brush for Hair

Personal cleaning product with ergonomically designed and features anti-slip long handle. The extra-long and curved designed handle can help to hygiene practices without uncomfortable feeling.

BIDET



54 BD PT

Bidet

Easy assembly with standard toilet.

BATH AIDS



54 AJI BH 2F DR/ EQ .35.
IM 1000x600mm
1,4 kg

Stainless Steel Bathroom Handle 2 Right Fixing (Smooth Escob)



54 AJI BH 3F DR/ EQ .35.
IM 1000x600mm
1.6 kg

Stainless Steel Handle
3 Fixation Right (Escob relie)



54 AJI BH SI.35.IM
35,50,70,90,110 mm
-0.9kg - 1.2 kg

Senci Inox Bathroom Handle 35Cm (35) (Escob relie)



54 AJ I SN AR PA DR-EQ
35.IM 800x280mm
2kg

Asid Inod Articul Wall Inox Der (35) (Smooth Escob)



54 AJI LV DR/ EQ .35.IM
660x340mm
1.8 kg

Inox sink handle right (Escob relie)



54 AJI SN PA DR/ EQ .35.
IM 800x340mm
2.0 kg

Inod Wall Handle Inox Wall (35) (Escob relie)



54 AJI SN CH DR/ EQ .35.
IM 830x700mm
2.0 kg

Stainless Steel Handle Inod Der (35) (Escob relie)



54 AJI SN AR PA SR.35.IM
800x280mm
2.3 kg

Asid Inod Art Wall Inox Sp Roll (35) (Escob relie)

In resistant stainless steel with anti skidding bubbles. Screws included. Diameters: 35mm. User's maximum weight: 150kg

PORTABLE BATH



54 CR 3 BH H
Steel Washing Car

Steel structure with epoxy paint and anti-corrosion treatment. Bath with phenolic base and surface in foam protected by PVC thermo welding. Hydraulic elevation from 45 to 80cm. With four 125mm wheels with integrated brakes. Folding rails epoxy painted. Wall protections. Available model in stainless steel. Option: central brake. Option: trendelenburg and anti-trendelenburg



Folding Handrails



Hydraulic Lift



Protection of Walls

MEASUREMENTS

in cm / kg - tolerance +/- 1

WASHING CAR



201



187



90



70



80 max
45 min



175-acero
225-inoxidable

DURABILITY



DESIGN



COMFORT

*Why does it need to
be **black and white?**
At Orthos Bath & Clean
we ensure **rust free,**
we provide **comfort,**
we have **colour and**
i n n o v a t i o n . . .*

ORTHOSMAIA XXI

C/ Manuel Nuñez no2 Ofic.9 Pl. 3 I 36203 Vigo I España
Tel: (+34) 886 312 806
Móvil: (+34) 678 994 993
E-mail: comercialespana@orthosxxi.com

ORTHOS XXI, Unipessoal Lda.

Rua de Santa Leocádia I 4809-012 Santa Leocádia de Briteiros
Guimarães I Portugal
Móvil: (+351) 253 470 276/ 77/ 70
E-mail: sofia.martins@orthosxxi.com
margarida.silva@orthosxxi.com
Fax: (+351) 253 470 278
info@orthosxxi.com

www.orthosxxi.com

by

ORTHOS
xxi
e u r o p e a n
i n c l u s i v e s o l u t i o n s

ORT HOS

inclusive solutions

TRANSFER

TRANSFER

Quality
Safety
Comfort





ORTHOS

XXI
e u r o p e a n
i n c l u s i v e s o l u t i o n s



HISTORY

Orthos XXI originated from Conrado Dias Lda., a company founded in 1975 in Porto, Portugal.

In 1985, with great support from the owners Mr. Dias and Mrs. Marília, that the Mr. Ribeiro and Mrs. Zilda, decide to give continuity to the business of production and commercialization of walking aids, with the name of Ortomaia, thus concretizing an old aspiration of the Sñr. Ribeiro owning a business. This new company has the assiduous collaboration of Manuel and Luisa and with the timely help of their other children, thus naturally involving the whole family in the process. The bases that make up the current dynamic of Orthos XXI were launched, based on values of affection and proximity among all generations of collaborators.

Together with the production activity, the distribution of products from national and international companies of great importance in the Sector is included in its portfolio.

In 1989, a wheelchair production unit was acquired and integrated, giving rise to two independent and distinct production units, but with joint commercialization.

In 1996 it was necessary to expand, integrate and fully optimize the business, so it was built in Guimarães, a new warehouse with twice the area to accommodate all the aspects of the business. With a view to the expansion and evolution of the activity, in 2007 Several decisive steps are taken:

A process of professionalization of management begins by separating the shareholder structure from the management structure, thus formally creating Orthos XXI.

A production unit for Geriatric and Hospital beds was installed and the facilities for the double were expanded again.

Direct participation in the Spanish market began, creating a commercial structure, OrthosMaia XXI, in Spain.

They initiate and develop several commercial actions to expand and develop new markets and new businesses.

In 2012, a consolidation and product development department was created, which, together with the continuous improvement of the Organization, has allowed the product range to be substantially expanded.

In 2017/18 Orthos XXI, reformulates its marketing and commercial strategy, organizing its product portfolio in ten brands.

We have a base with a productive DNA that allows us to continue production in Europe and a brand-oriented trade strategy to be able to face the competition of multinationals and Asian importers.

QUALITY

The quality of the ORTHOS XXI products can be confirmed in the best hospitals and institutions, where they have chosen us. Most of our products are class I medical devices and bear the CE mark, according to the Community Directives 93/42 / CEE and 2007/47 / CE and are registered in the competent Authority, Infarmed. They are tested by accredited and independent entities, such as the IBV (Institute of Biomechanics of Valencia, in Spain). The company is also certified according to the EN ISO 9001 standard.

The value and qualification of human resources through the implementation of activity is training and updating in different areas have been strong bets of our company. ORTHOS XXI's main concern is the continuous improvement of production processes and services, as well as the improvement of the quality of its products, which allows us to better meet the needs and requirements of customers and users.

VALUES

We are driven by the conviction that, with our work, we contribute daily to improve the quality of life and to satisfy the needs of the users of our products and services. We prioritize an attitude of teamwork, flexibility and continuous improvement. We consider fundamental a constant investment in innovation and development of the products, currently counting on a team dedicated exclusively to this purpose.

These values support the presentation, in this new catalog, of some of the most recently developed novelties and, at the same time, to respond to the personalized needs of the users.



MANUAL TRANSFER EQUIPMENT

Easy Transfer, Transfer Belt, Transfer Harness Chair,
Transfer Disk and Transfer Table

pág 6-7

HOISTS

Eclipse 135/150/180, Eclipse 180 plus/220, Eclipse Duo, Eclipse Stand-up

pág 9-12

SLINGS

Lumbar Back Slings, Tetraplegic Slings, Amputee Slings

pág 14-15

RAMPS

Simple Ramps, Folding 2 Parts,
Telescopic 2 and 3 Parts, Telescopic and Folding

pág 16-17

CLIMB STAIRS

Cmax, Smax

pág 18





EASY TRANSFER

Pág 6

BELT AND CHAIR HARNESS OF TRANSFER

Pág 7

TRANSFER TURNTABLE AND TRANSFER BORD

Pág 7

EASY TRANSFER



56 AP 0 TR ET CP
EASY TRANSFER COMPACT

EASY TRANSFER is an easy-to-use everyday device. Designed for daily needs such as transferring from bed to bath. It allows the user to move safely and effortlessly. The seat swivels for easy entry. With footrest and padded knee support. Handles for user and caregiver. Available in either the compact version (with 5 wheels) or with the opening of legs (with 4 wheels). The height of the seat can be fixed or adjustable through gas pumps to facilitate user access. It is an excellent solution for institutional use. However, due to the compact dimensions, it can also be easily used at home, helping to prevent the appearance of injuries in caregivers.



Easy Transfer with leg opening

MEASUREMENTS

in cm / kg - tolerance +/- 1

EASY TRANSFER COMPACT
EASY TRANSFER LEG OPENING



62.8



61
108.2



79.8



89.2
102.7



10
10



42.5
42.5



150
150

TRANSFER BELT



Belt with tabs indicated for transfer chair/bed or chair/chair. It can be combined with other devices (eg turntable)

56 CT NO AB
Transfer belt

TRANSFER HARNESS CHAIR



Allows the user to be transferred in a seated position with back support. The transfer is performed by two caregivers.

56 AR CD
Transfer chair

TRANSFER TURNTABLE



56 DI RT
Rotating disc diameter 40 cm

Swiveling, lightweight, sturdy transfer turntable rotates easily. Facilitates patient rotation in transfer situations, such as bed/chair, chair/car transfers and other similar situations.

Diameter: 40cm
Weight: 1kg

TRANSFER BOARD

Transfer board in solid cedar wood, to assist the carrying out of transfers carried out through a process of sliding.

With non-skid tracks at the base. Robust and practical.

Dimensions:
65 x 20 cm



56 TB TR MD
Wooden transfer table

HOISTS

pág 9-12



ECLIPSE 135

Pág 9

ECLIPSE 150

Pág 9

ECLIPSE 180

Pág 9

ECLIPSE 180 PLUS / 220

Pág 10

ECLIPSE DUO

Pág 11

ECLIPSE STAND-UP

Pág 12

ECLIPSE 135/150/180

ECLIPSE, hoist for a comfortable and safe transfer with maximum space for the user. It offers great stability and with great amplitude - low until collecting the user of the ground, rises up to 182 cm. Easy to maneuver, with Ø100mm double wheels, swivel and anti-wires. Very compact base suitable for narrow spaces and tight corners, with new ergonomic lever. Electric actuator, equipped with safety system in case of electrical failure and 2 batteries of 24v, emergency brake and mechanical anti-panic lowering. It assembles and dismounts in less than 1 minute. Also available ECLIPSE 150 hydraulic and ECLIPSE 150 stand-up.



56 GR 3 EL EC 135
ECLIPSE 135 - Folding electric hoist



Robust steel hanger support

TECHNICAL CHARACTERISTICS



Motor









Ergonomic lever



Double wheels
Ø100mm, anti-thread

MEASUREMENTS

in cm / kg - tolerance +/- 1

							
ECLIPSE 135	95	44.8	83.9	89.9	175	49	135
ECLIPSE 150	110	51.1	98.9	89.9	175	49	150
ECLIPSE 150 HYDRAULICS	110	51.1	98.9	89.9	175	49	150
ECLIPSE 180	130	51.1	114.8	89.9	175	51	180

ECLIPSE 180 PLUS/220



56 GR 3 EL EC 180 PL / 56 GR 3 EL EC 220

ECLIPSE 180 - Folding electric hoist - ECLIPSE 220 - Folding electric hoist

Specially designed to facilitate the incorporation of a person of any type of seat or wheelchair and its transfer in perfect harmony with the anthropometric characteristics of the user. It offers great stability and is easy to use. Disassembles in two parts. Its dimensions allow the use in narrow passages in domestic environments, rest homes and hospitals, with the perfect control by the caregiver. Several types of harnesses available.



MEASUREMENTS

in cm / kg - tolerance +/- 1

ECLIPSE 180 PLUS

ECLIPSE 220



130



51.1



114.8



89.9



175



51



180

ECLIPSE DUO, with maximum space for the user, ORTHOS XXI's transfer lifter provides a convenient transfer either from bed, wheelchair or even the floor with its mobility arm. The base legs are equipped with two sets of wheels (4 wheels total, 2 with brakes), it is opened with a lever to simplify the front access of wheelchairs with stability and security. The arm movement is ensured by an electric actuator, equipped with a security system in case of power failure and powered by 2 batteries of 24V, with control buttons to raise or lower and an automatic emergency brake. The elevating arm was specially designed to facilitate the incorporation of a person from any kind of seat or wheelchair and to transfer them in perfect harmony with the anthropometric features. Offers great stability and it's easy to use. The lifter is detachable in two parts, its size allows use in narrow spaces at home, geriatric or hospital environments, with total control of the caregiver. A wide range of harnesses available.



56 GR 3 EL CP 150 DUO

ECLIPSE DUO 150

TECHNICAL CHARACTERISTICS



MEASUREMENTS

in cm / kg - tolerance +/- 1

Eclipse duo mobilization
Eclipse duo standing



52



31



33



90



67



49



150

55

55

34

33

90

67

49

150

ECLIPSE STAND-UP



56 GR 3 EL CP 150

ECLIPSE STAND-UP 150 Foldable 150 (with harness)

Designed especially to facilitate the incorporation of a person from any type of seat or wheelchair and its transfer in perfect harmony with the anthropometric characteristics of the user. It offers great stability and easy use. Removable in two parts. Its dimensions make it possible to use it in narrow passages at home, geriatric environments and hospitals, with the perfect control of the caregiver. Various types of harnesses available.



Simple padded transfer harness



Harness extra comfort transfer (option)

MEASUREMENTS

in cm / kg - tolerance +/- 1

Eclipse stand-up
Simple Harness

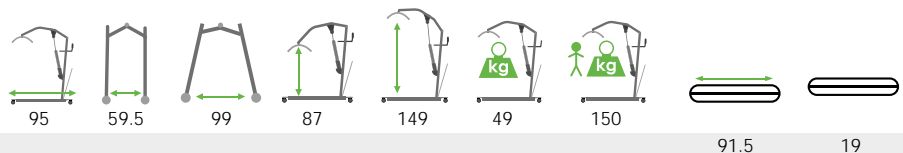

SLINGS

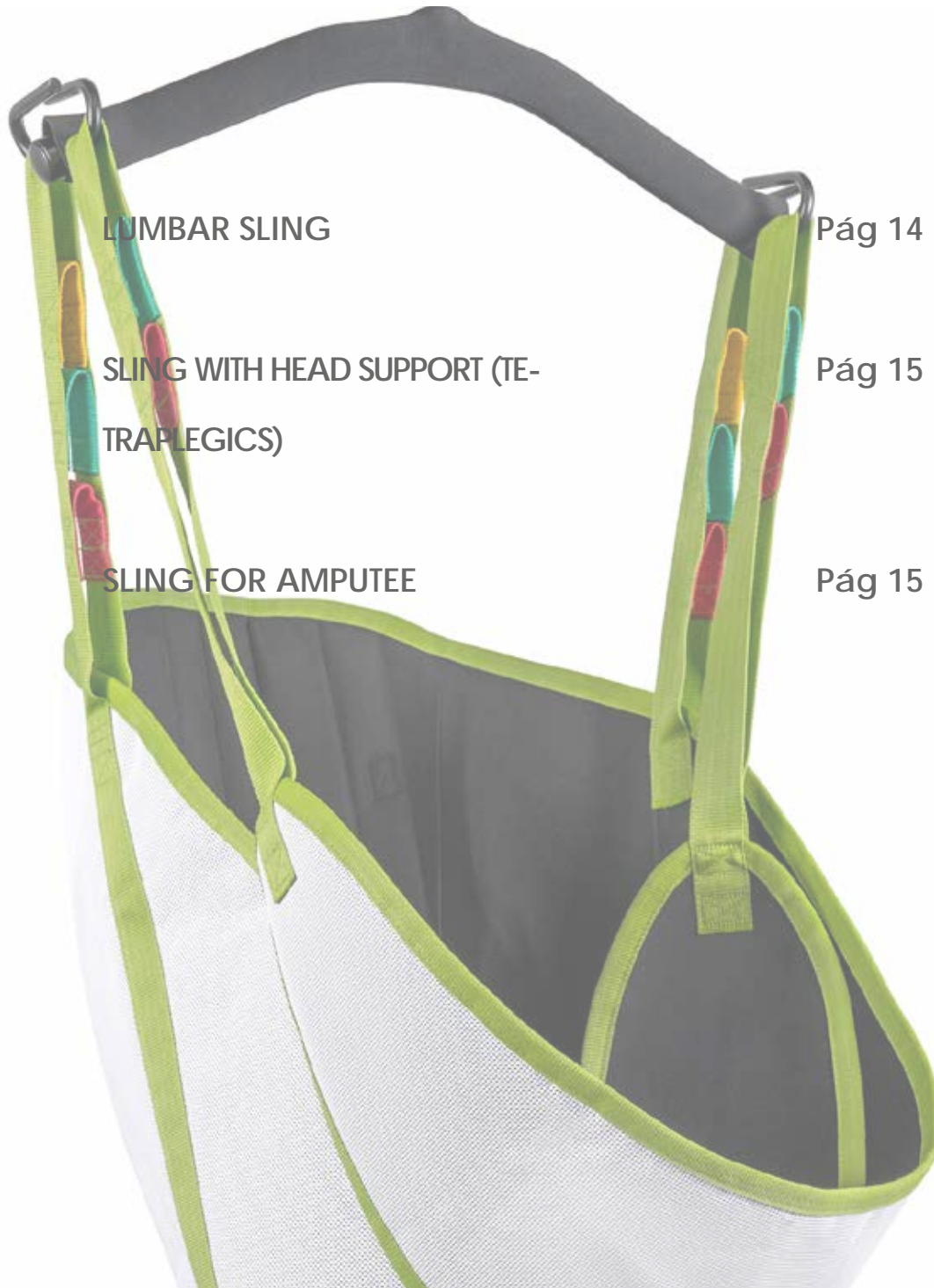

LUMBAR SLING

Pág 14

SLING WITH HEAD SUPPORT (TE-
TRAPLEGICS)

Pág 15

SLING FOR AMPUTEE

Pág 15

pág 14-15

LUMBAR SLING



Designed to cover the needs of the user, depending on their mobility, their pathology and type of transfer. Lumbar sling with 3 types of finish: padded line and comfort line for bed/chair/sofa transfer and washable PVC bath line. All models have two faces and a padded interior, constituting a strong and robust sling. Various sizes available.



Bath line

56 AR DL BH .S
Harness Back - Lumbar Bath S



Comfort line



Padded line



Bath line



Harness transfer back-lumbar comfort line

MEASUREMENTS

in cm / kg - tolerance +/- 1

LUMBAR SLING XS	70	92	49	43	150
LUMBAR SLING S	74	100	53	47	150
LUMBAR SLING M	90	110	59	51	150
LUMBAR SLING L	101	122	65	57	150
LUMBAR SLING XL	109	131	67	64	200
LUMBAR SLING XXL	114	139	69	70	300

SLING WITH HEAD SUPPORT (TETRAPLEGICS)

Designed to cover the needs of the user, depending on their mobility, their pathology and type of transfer. Sling with head support with 3 types of finish: padded line and comfort line for bed/chair/sofa transfer and washable PVC bath line. All models have two faces and a padded interior, constituting a strong and robust sling. Various sizes available.



Padding line - head support



56 AR TT AC .M
Sling Head Support / Tetra Padded M

SLING FOR AMPUTEE

Designed to cover the needs of the user, depending on their mobility, their pathology and type of transfer. Sling for amputees with 3 types of finish: padded line and comfort line for bed/chair/sofa transfer and washable PVC bath line. All models have two faces and a padded interior, constituting a strong and robust sling. Various sizes available.



56 AR SP BH .M
Sling for amputees

MEASUREMENTS

in cm / kg - tolerance +/- 1

SLING WITH HEAD SUPPORT XS	70	125	49	76	42	150
SLING WITH HEAD SUPPORT S	74	133	53	80	42	150
SLING WITH HEAD SUPPORT M	90	143	59	84	42	150
SLING WITH HEAD SUPPORT L	102	155	65	90	42	150
SLING FOR AMPUTES M	96	104				150
SLING FOR AMPUTES L	103	110				150

RAMPS

SIMPLE RAMP



57 RP X FX 055
Simple ramp S - 55cm - Step 11cm

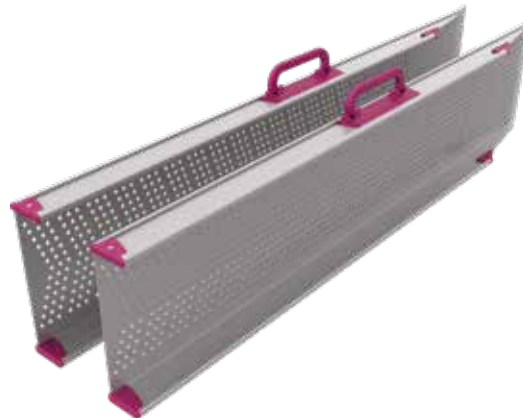

57 RP X FX 117
Simple ramp S - 117cm - Step 23cm

Specially developed for power wheelchairs and scooters, also correspondingly more reliable when used with manual wheelchairs. Made of aluminum, robust and very light, easy to carry. Anti-slip surface.

MEASUREMENTS

in cm / kg - tolerance +/- 1

Simple ramp 55	55	21	11	2.9	400
Simple ramp 120	117	21	23	5.9	400

FOLDABLE RAMP - 2 PARTS



57 RP X DB 110
Foldable ramp - 55/110cm



57 RP X DB 200
Foldable ramp - 100/200cm

Specially developed for power wheelchairs and scooters, also correspondingly more reliable when used with manual wheelchairs. Made of aluminum, robust and very light, easy to carry. Anti-slip surface.

MEASUREMENTS

in cm / kg - tolerance +/- 1

Foldable ramp 110	110	21	22	7.1	400
Foldable ramp 200	200	21	40	11.9	300

TELESCOPIC RAMP - 2 AND 3 PARTS

Specially developed for power wheelchairs and scooters, also correspondingly more reliable when used with manual wheelchairs. Made of aluminum, robust and very light, easy to carry. Anti-slip surface.



57 RP X TE 120
Telescopic Ramp T2 - 120 cm - Step 20cm



57 RP X TE 203
Telescopic Ramp T2 - 203 cm - Step 40cm



57 RP X TL 3X 289
Telescopic Ramp T3 - 289 cm - Step 58cm



MEASUREMENTS

in cm / kg - tolerance +/- 1

Telescopic - 2 parts 120	120	19.5	24	7.4	350
Telescopic - 2 parts 200	200	19.5	40	11.4	300
Telescopic - 3 parts 290	290	18	58	16.5	250

TELESCOPIC AND FOLDABLE

Specially developed for power wheelchairs and scooters, also correspondingly more reliable when used with manual wheelchairs. Made of aluminum, robust and very light, easy to carry. Anti-slip surface.



57 RP X TL DB 277
Telescopic and foldable ramp FT3-277cm - Step 60cm

MEDIDAS

en cm/kg - tolerancia +/- 1

Telescopic and foldable 280	277	19.5	60	16.6	250

CLIMB STAIRS

C MAX



C MAX

Seat height	50cm
Total height	109-144cm
Backrest height	66cm
Total width	68cm
Total depth	78.5cm
Weight	35.8kg

Wheelchair with integrated device for climbing stairs. For people who need help to climb stairs. The chair has particularly narrow measures being very functional and compact in narrow and even snail stairs.

57 AP 3 SE C MAX

Climb Ladder System- C Max U1

S MAX



S MAX

Weight	22kg Suitable for wheelchairs that vary between 32cm and 60cm of seat width (1)
Maximum load	120kg
Ascent speed	8-23 minute stairs

(1) It is necessary to adapt the wheelchair in the factory and in some cases it will not be technically possible to do so.

Device adaptable to wheelchair to climb stairs. Climb stairs sitting in your chair with greater ease, speed and total security. The S-max system can adapt to almost all wheelchairs, including children wheelchair. Sensitive and safe handling. Ergonomic, ensures greater safety during transfer. You can select the speed to climb the stairs and adapt it to each situation, particularly on spiral staircases. The maintenance-free batteries allow you to climb up to 300 steps.

57 AP 3 SE S MAX

System Climbs Ladders- S Max U3

CALIDAD



SEGURIDAD



CONFORT

*At Orthos Transfer
we have a wide
range of solutions,
we are concerned
about your **comfort**
and about the
health and safety
of your carer...*

ORTHOSMAIA XXI

C/ Manuel Nuñez no2 Ofic.9 Pl. 3 I 36203 Vigo I España
Tel: (+34) 886 312 806
Móvil: (+34) 678 994 993
E-mail: comercialespana@orthosxxi.com

ORTHOS XXI, Unipessoal Lda.

Rua de Santa Leocádia I 4809-012 Santa Leocádia de Briteiros
Guimarães I Portugal
Phone: (+351) 253 470 276/ 77/ 70
E-mail: sofia.martins@orthosxxi.com
margarida.silva@orthosxxi.com
Fax: (+351) 253 470 278
info@orthosxxi.com

www.orthosxxi.com

by

ORTHOS
xxi
e u r o p e a n
i n c l u s i v e s o l u t i o n s

ORT HOS

inclusive solutions
HOSPITAL

HOSPITAL



WARD BEDS

pag 3

IICU BEDS

pag 18

BEDSIDE CABINETS

pag 39

TRANSPORT CHAIRS

pag 46

CHOUCHES

pag 49

STRETCHERS

pag 56

TROLLEYS

pag 61

FURNITURE

pag 69

AMAGNETIC

pag 77

PHYSIOTHERAPY

pag 80

WARD BEDS

VICTORY HO HI-LOW

Pag 04

VICTORY ABS HO HI-LOW

Pag 06

HARMONY BASIC

Pag 08

PRIDE BASIC

Pag 13



VICTORY HO HI-LOW

Customized model



VICTORY HO, hospital electric bed designed and recommended for environments with medium or high bacteriological risk. Robust 60x30x1.5mm steel frame with epoxy paint. Victory frame with four sections, three articulated and one fixed, with polymer fibre slats, which allow for easy disinfection and reduce bacteriological risks. Independent electrical articulation of the backrest and legs, through 6000N low-voltage motors suitable for hospital environments. Bed elevation by electric double H elevator (photo) or scissor elevator, guarantees robustness and lateral stability. Simple and intuitive user control. Detachable headboards and footboards in HPL (phenolic

compact, grey), for easy access and disinfection. Includes 3 plastic blockers to avoid movement of mattress. With wall protectors on 4 corners. Structure prepared for the application of 2 poles (ex. IV pole and monkey pole). 125mm ABS wheels (with double H elevator) or 100mm steel wheels (scissor elevator), 2 with brakes. Prepared for application of steel universal folding side rails with epoxy paint. Maximum user weight: 195Kg. SWL: 230Kg. CE Certification. Manufactured in accordance with EU hospital beds standards.

Option: Victory HO manual, with 2 cranks for manual operation of head and legs sections.

Features



Independent articulation

Independent motors for backrest and legs articulation and hi-lo



Disinfection

Polymer slats, suitable for environments with high bacteriological risk



Electric joystick

Easy and intuitive to use



Headboards

In HPL with metallic arch



Double H Hi-lo

Lifting by "double H" articulated arms guarantees robustness and lateral stability. 125mm ABS wheels



Scissor Hi-lo

Lifting by "scissor structure" with 100mm steel wheels

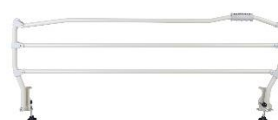

Side rails

Optional

Technical data

VICTORY HO HI-LOW

Manufacturer: Orthos XXI

Frame width	90cm	Legs angle	0°-33°
Frame length	196cm	Wheels double H/scissor	125/100mm
Total width	100cm	Structure colour	Beige
Total length	205cm	Slats	Polymer
Minimum height double H/scissor	42/41cm	Maximum user weight	195Kg
Maximum height double H/scissor	76/75cm	SWL (safe work load)	230Kg
Backrest angle	0°-71°		

Tolerance: +/-1cm

NOTE: in case of divergence between text and image, prevails the information described in the text. For continuous improvement, Orthos XXI reserves the right to make changes to its products without prior notice. More information available in the product manual.

Update: 04/20

ORTHOS XXI, Unipessoal Lda.

Rua Santa Leocádia nº2735 // 4809-012 Sta. Leocádia de Briteiros // Guimarães // Portugal

Phone + 351 253 470 276 // Mobile +351 936 199 005 // Email margarida.silva@orthosxxi.com // Website www.orthosxxi.com

VICTORY ABS HO HI-LOW

Customized model



VICTORY HO, hospital electric bed designed and recommended for environments with medium or high bacteriological risk. Robust 60x30x1.5mm steel frame with epoxy paint. Victory frame with four sections, three articulated and one fixed, with polymer fibre slats, which allow easy disinfection and reduce bacteriological risks. Includes 3 plastic blockers to avoid movement of mattress. Independent electrical articulation of the backrest and legs, through low-voltage motors suitable for hospital environments. Bed elevation by electric double H elevator (photo) or scissor elevator. Simple and intuitive user control. Detachable

ABS headboards and footboards for easy access and disinfection. With wall protectors on 4 corners. Structure prepared for the application of 2 poles (ex. IV pole and monkey pole). 125mm wheels (with double H elevator) or 100mm steel wheels (scissor elevator), 2 with brakes. Optional (on photo): steel universal folding side rails with epoxy paint, central brake. Maximum user weight: 195Kg. SWL: 230Kg. CE Certification. Manufactured in accordance with EU hospital beds standards.

Option: Victory HO manual, with 2 cranks for manual operation of head and legs sections.

Features



Independent articulation

Independent motors for backrest and legs articulation and hi-lo



Disinfection

Polymer slats, suitable for environments with high bacteriological risk



Electric joystick

Easy and intuitive to use



Headboards

In ABS



Double H Hi-lo

Lifting by "double H" articulated arms guarantees robustness and lateral stability. 125mm wheels



Scissor Hi-lo

Lifting by "scissor structure" with 100mm steel wheels

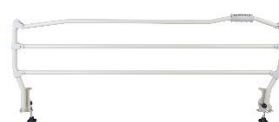

Side rails

Optional



Central brake

Optional

Technical data

VICTORY ABS HO HI-LOW

Manufacturer: Orthos XXI

Frame width	90cm	Legs angle	0°-33°
Frame length	196cm	Wheels double H/scissor	125/100mm
Total width	100cm	Structure colour	Beige
Total length	205cm	Slats	Polymer
Minimum height double H/scissor	42/41cm	Maximum user weight	195Kg
Maximum height double H/scissor	76/75cm	SWL (safe work load)	230Kg
Backrest angle	0°-71°		

Tolerance: +/-1cm

NOTE: in case of divergence between text and image, prevails the information described in the text. For continuous improvement, Orthos XXI reserves the right to make changes to its products without prior notice. More information available in the product manual.

Update: 04/20

ORTHOS XXI, Unipessoal Lda.

Rua Santa Leocádia nº2735 // 4809-012 Sta. Leocádia de Briteiros // Guimarães // Portugal

Phone + 351 253 470 276 // Mobile +351 936 199 005 // Email margarida.silva@orthosxxi.com // Website www.orthosxxi.com

HARMONY BASIC



Hospital bed specifically conceived for use in environments with high bacteriological risk, with materials resistant to disinfection. Steel frame with epoxy paint. Articulated bed of 4 planes (fixed pelvic section and 3 articulated sections), in phenolic resin, with holes for ventilation of the mattress. Headboards and footboards in phenolic resin. 125mm wheels with brake. Electrical articulation of the back and legs. Structure prepared for different configurations. It allows to attach different

accessories. Compatibility with other equipment (eg hoists). Robust and resistant materials to the disinfection recommended in hospital environment. Available model with fixed height (**HARMONY BASIC**), with bed elevation (**HARMONY BASIC ELEVAR**) and with elevation, Trendelenburg and reverse (**HARMONY BASIC TREN**). Maximum user weight: 200 kg. Safety load: 285Kg. Possibility of manufacturing by measure.

Features

Robustness and resistance to oxidation

Structure in welded steel tube ST37, with a minimum thickness of 1,5mm. Laser-cut sheets, properly polished and pickled in order to eliminate edges and cutting oxides at the edges.

A 3-step paint process (degreasing, washing and phosphatation), with an ultraviolet resistant epoxy paint finish and with a degree of resistance to salt spray of 1000h (test performed in accordance with ASTM B117 without any visible signs of corrosion). Anti-bacterial paint, resistant to chemical attacks.

Phenolic resin bed with high resistance to shock and corrosion. Allows optimal cleaning and disinfection.

Stability

Lifting system (HARMONY BASIC ELEVAR and HARMONY BASIC TREN) with 4 points of support, by articulated arms - double H - guarantees optimum lateral and longitudinal stability.

Safety

Electrical system with independent motors, in order to minimize impacts and costs in case of failure. Protection against electrocution. Electromagnetic compatibility with electrical and electronic medical equipment. Command with a unique system of protection against rapid and repeated actions of rise / fall, causing damages in the relays, what minimizes potential costs of substitution of commands. Electrical cable with connector to avoid damages by accidental stretching of the same.

Easy to move

Four-wheel travel system 125mm (other available options, namely central brake with directional wheels and an anti-static wheel). High quality wheels and durability, excellent wear resistance and good oxidation protection. Headboards and footboards with lateral opening to facilitate the driving of the bed.

Comfort and ergonomics

Articulated bed of 4 planes.

Easy cleaning and infection control

Robust and resistant materials to the disinfection recommended in hospital environment. Reduced number of grooves / joints to avoid points of accumulation of waste. Smooth and accessible surfaces. Detachable bed panels for quick and easy cleaning and disinfection.

Functionality

Simple and intuitive user control. Patient command for electric articulation of back, legs, bed elevation (HARMONY BASIC ELEVAR and HARMONY BASIC TREN), Trendelenburg and reverse (HARMONY BASIC TREN). The actuation of the various motors allows several positions such as Fowler and heart chair (HARMONY BASIC TREN).

Configuration

Structure prepared to apply supports in the 4 corners of the bed. Various options and accessories available. Possibility of manufacturing by measure.

ORTHOS XXI, Unipessoal Lda.

Rua Santa Leocádia nº2735 // 4809-012 Sta. Leocádia de Briteiros // Guimarães // Portugal

Phone + 351 253 470 276 // Mobile +351 936 199 005 // Email margarida.silva@orthosxxi.com // Website www.orthosxxi.com

Side rails

Folding universal side rails (option): painted steel or chrome plated steel. Compliance with IEC 60601-2-52.

Compatibility

Compatible with the use of other medical devices such as transfer hoists.

Certification

Portuguese product, duly certified. See declaration of conformity and Registration of Infarmed. Meets standards for hospital beds IEC 60601-1; IEC 60601-2-52; IEC 60601-1-11.

Technical data

HARMONY BASIC HARMONY BASIC ELEVAR HARMONY BASIC TREN			
Manufacturer: Orthos XXI Reference: 55 CM 3 HA BS 55 CM 3 HA BS EL 55 CM 3 HA BS TD			
Back section support - inclination angle	70°	Maximum mattress platform height	760mm
Legs section support - inclination angle	30°	Total length	2110mm
Trendelenburg and reverse	15°/-15°	Overall width	960mm
Mattress platform length	1900mm	Maximum user weight	200Kg
Mattress platform width	900mm	Safe Workload (SWL)	285Kg
Minimum mattress platform height	420mm		

Tolerance: +/-1cm

ORTHOS XXI, Unipessoal Lda.

Rua Santa Leocádia nº2735 // 4809-012 Sta. Leocádia de Briteiros // Guimarães // Portugal

Phone + 351 253 470 276 // Mobile +351 936 199 005 // Email margarida.silva@orthosxxi.com // Website www.orthosxxi.com

Configuration and Accessories

Characteristics	HARMONY BASIC	HARMONY BASIC ELEVAR	HARMONY BASIC TREN
ELEVATOR			
Height adjustable elevator	-	✓	-
Height adjustable elevator, Trendelenburg and reverse	-	-	✓
TYPE OF LEGS (applicable to bed without elevator)			
Double wheels nylon 100mm	○	-	-
Double wheels nylon 125mm	✓	-	-
TYPE OF WHEELS (applicable to bed without elevator)			
Single steel wheels 100mm	-	○	○
Single wheels steel 125mm	-	✓	✓
Double wheels nylon 100mm	-	○	○
Double wheels nylon 125mm	-	○	○
Double Wheels Tente 75-100mm	-	○	○
Double Wheels Tente 100-120mm	-	○	○
Double Wheels Tente 100-150mm	-	○	○
Single steel wheels with center brake 125mm	-	○	○
Double nylon wheels with central brake 125mm	-	○	○
Double nylon wheels with central brake 150mm	-	○	○
5th wheel	-	○	○
HEADBOARDS AND FOOTBOARDS			
Phenolic resin headboards and footboards	✓	✓	✓
SIDE RAILS			
Universal folding side rails in painted steel	○	○	○
Universal chrome steel folding side rails	○	○	○
COMMANDS			
Patient command	✓	✓	✓
ELECTRICAL FUNCTIONS			
Articulation of back	✓	✓	✓
Articulation of the legs	✓	✓	✓
Hi-Lo	-	✓	✓
Trendelenburg and reverse	-	-	✓
Fowler (2-button combination)	✓	✓	✓
Cardiac chair (3-button combination)	-	-	✓

"✓": característica standard; "○": opção; "-": não aplicável

ORTHOS XXI, Unipessoal Lda.

Rua Santa Leocádia n°2735 // 4809-012 Sta. Leocádia de Briteiros // Guimarães // Portugal

Phone + 351 253 470 276 // Mobile +351 936 199 005 // Email margarida.silva@orthosxxi.com // Website www.orthosxxi.com

Characteristics	HARMONY BASIC	HARMONY BASIC ELEAR	HARMONY BASIC TREN
SECURITY FUNCTIONS			
Mechanical CPR	○	○	○
Battery	○	○	○
ACCESSORIES			
Chrome pendant	○	○	○
IV support 2 nylon hooks	○	○	○
IV support 2 stainless steel hooks	○	○	○
IV support 4 stainless steel hooks	○	○	○
IV support with wheels	○	○	○
Urine bag support	○	○	○
Urinal support	○	○	○
Patient identification plate	○	○	○
Clinical file support	○	○	○
Foldable annotation holder	○	○	○
Monitor stand with wheels	○	○	○
Oxygen bottle holder	○	○	○
Fixing for containment systems	○	○	○

"✓": standard feature; "○": option; "-": not applicable

NOTE: in case of divergence between text and image, prevails the information described in the text. For continuous improvement, Orthos XXI reserves the right to make changes to its products without prior notice. More information available in the product manual.

Update: 04/19

ORTHOS XXI, Unipessoal Lda.

Rua Santa Leocádia nº2735 // 4809-012 Sta. Leocádia de Briteiros // Guimarães // Portugal

Phone + 351 253 470 276 // Mobile +351 936 199 005 // Email margarida.silva@orthosxxi.com // Website www.orthosxxi.com

PRIDE BASIC



PRIDE BASIC, hospital bed specifically conceived for use in environments with high bacteriological risk, with materials resistant to disinfection. Steel frame with epoxy paint. Articulated bed of 4 planes (fixed pelvic section and 3 articulated sections), in ABS, with holes for ventilation of the mattress. Headboards and footboards in ABS, easily detachable. Protection stops in the 4 corners of the bed. 125mm wheels with brake. Electrical articulation of the back and legs. Structure prepared for different

configurations. It allows to attach different accessories. Compatibility with other equipment (eg hoists). Robust and resistant materials to the disinfection recommended in hospital environment. Available model with fixed height (**PRIDE BASIC**), with bed elevation (**PRIDE BASIC ELEV**) and with elevation, Trendelenburg and reverse (**PRIDE BASIC TREN**). Maximum user weight: 200 kg. Safety load: 285Kg. Possibility of manufacturing by measure.

Features

Robustness and resistance to oxidation

Structure in welded steel tube ST37, with a minimum thickness of 1,5mm. Laser-cut sheets, properly polished and pickled in order to eliminate edges and cutting oxides at the edges.

A 3-step paint process (degreasing, washing and phosphatation), with an ultraviolet resistant epoxy paint finish and with a degree of resistance to salt spray of 1000h (test performed in accordance with ASTM B117 without any visible signs of corrosion). Anti-bacterial paint, resistant to chemical attacks.

ABS bed with high resistance to shock and corrosion. Allows optimal cleaning and disinfection.

Stability

Lifting system (PRIDE BASIC ELEVAR and PRIDE BASIC TREN) with 4 points of support, by articulated arms - double H - guarantees optimum lateral and longitudinal stability.

Safety

Electrical system with independent motors, in order to minimize impacts and costs in case of failure. Protection against electrocution. Electromagnetic compatibility with electrical and electronic medical equipment. Command with a unique system of protection against rapid and repeated actions of rise / fall, causing damages in the relays, what minimizes potential costs of substitution of commands. Electrical cable with connector to avoid damages by accidental stretching of the same.

Easy to move

Four-wheel travel system 125mm (other available options, namely central brake with directional wheels and an anti-static wheel). High quality wheels and durability, excellent wear resistance and good oxidation protection. Headboards and footboards with lateral opening to facilitate the driving of the bed.

Comfort and ergonomics

Articulated bed of 4 planes.

Easy cleaning and infection control

Robust and resistant materials to the disinfection recommended in hospital environment. Reduced number of grooves / joints to avoid points of accumulation of waste. Smooth and accessible surfaces. Detachable bed panels for quick and easy cleaning and disinfection.

Functionality

Simple and intuitive user control. Patient command for electric articulation of back, legs, bed elevation (PRIDE BASIC ELEVAR and PRIDE BASIC TREN), Trendelenburg and reverse (PRIDE BASIC TREN). The actuation of the various motors allows several positions such as Fowler and heart chair (PRIDE BASIC TREN).

Configuration

Structure prepared to apply supports in the 4 corners of the bed. Various options and accessories available. Possibility of manufacturing by measure.

ORTHOS XXI, Unipessoal Lda.

Rua Santa Leocádia nº2735 // 4809-012 Sta. Leocádia de Briteiros // Guimarães // Portugal

Phone + 351 253 470 276 // Mobile +351 936 199 005 // Email margarida.silva@orthosxxi.com // Website www.orthosxxi.com

Side rails

Folding universal side rails (option): painted steel or chrome plated steel. Compliance with IEC 60601-2-52.

Compatibility

Compatible with the use of other medical devices such as transfer hoists.

Certification

Portuguese product, duly certified. See declaration of conformity and Registration of Infarmed. Meets standards for hospital beds IEC 60601-1; IEC 60601-2-52; IEC 60601-1-11.

Technical data

PRIDE BASIC PRIDE BASIC ELEV PRIDE BASIC TREN			
Manufacturer: Orthos XXI Reference: 55 CM 3 PR BS 55 CM 3 PR BS EL 55 CM 3 PR BS TD			
Back section support - inclination angle	70°	Maximum mattress platform height	760mm
Legs section support - inclination angle	30°	Total length	2110mm
Trendelenburg and reverse	15°/-15°	Overall width	960mm
Mattress platform length	1900mm	Maximum user weight	200Kg
Mattress platform width	900mm	Safe Workload (SWL)	285Kg
Minimum mattress platform height	420mm		

Tolerance: +/-1cm

ORTHOS XXI, Unipessoal Lda.

Rua Santa Leocádia n°2735 // 4809-012 Sta. Leocádia de Briteiros // Guimarães // Portugal

Phone + 351 253 470 276 // Mobile +351 936 199 005 // Email margarida.silva@orthosxxi.com // Website www.orthosxxi.com

Configuration and Accessories

Characteristics	PRIDE BASIC	PRIDE BASIC ELEVATOR	PRIDE BASIC TREN
ELEVATOR			
Height adjustable elevator	-	✓	-
Height adjustable elevator, Trendelenburg and reverse	-	-	✓
TYPE OF LEGS (applicable to bed without elevator)			
Double wheels nylon 100mm	○	-	-
Double wheels nylon 125mm	✓	-	-
TYPE OF WHEELS (applicable to bed without elevator)			
Single steel wheels 100mm	-	○	○
Single wheels steel 125mm	-	✓	✓
Double wheels nylon 100mm	-	○	○
Double wheels nylon 125mm	-	○	○
Double Wheels Tente 75-100mm	-	○	○
Double Wheels Tente 100-120mm	-	○	○
Double Wheels Tente 100-150mm	-	○	○
Single steel wheels with center brake 125mm	-	○	○
Double nylon wheels with central brake 125mm	-	○	○
Double nylon wheels with central brake 150mm	-	○	○
5th wheel	-	○	○
HEADBOARDS AND FOOTBOARDS			
ABS headboards and footboards	✓	✓	✓
Headboards and footboards in phenolic resin	○	○	○
Headboards and footboards in phenolic resin/stainless steel	○	○	○
SIDE RAILS			
Universal folding side rails in painted steel	○	○	○
Universal chrome steel folding side rails	○	○	○
COMMANDS			
Patient command	✓	✓	✓
ELECTRICAL FUNCTIONS			
Articulation of back	✓	✓	✓
Articulation of the legs	✓	✓	✓
Hi-Lo	-	✓	✓
Trendelenburg and reverse	-	-	✓
Fowler (2-button combination)	✓	✓	✓
Cardiac chair (3-button combination)	-	-	✓

"✓": característica standard; "○": opção; "-": não aplicável

ORTHOS XXI, Unipessoal Lda.

Rua Santa Leocádia n°2735 // 4809-012 Sta. Leocádia de Briteiros // Guimarães // Portugal

Phone + 351 253 470 276 // Mobile +351 936 199 005 // Email margarida.silva@orthosxxi.com // Website www.orthosxxi.com

Characteristics	PRIDE BASIC	PRIDE BASIC ELEVAR	PRIDE BASIC TREN
SECURITY FUNCTIONS			
Mechanical CPR	○	○	○
Battery	○	○	○
ACCESSORIES			
Chrome pendant	○	○	○
IV support 2 nylon hooks	○	○	○
IV support 2 stainless steel hooks	○	○	○
IV support 4 stainless steel hooks	○	○	○
IV support with wheels	○	○	○
Urine bag support	○	○	○
Urinal support	○	○	○
Patient identification plate	○	○	○
Clinical file support	○	○	○
Foldable annotation holder	○	○	○
Monitor stand with wheels	○	○	○
Oxygen bottle holder	○	○	○
Fixing for containment systems	○	○	○

“√”: standard feature; “○”: option; “-”: not applicable

NOTE: in case of divergence between text and image, prevails the information described in the text. For continuous improvement, Orthos XXI reserves the right to make changes to its products without prior notice. More information available in the product manual.

Update: 08/19

ORTHOS XXI, Unipessoal Lda.

Rua Santa Leocádia nº2735 // 4809-012 Sta. Leocádia de Briteiros // Guimarães // Portugal

Phone + 351 253 470 276 // Mobile +351 936 199 005 // Email margarida.silva@orthosxxi.com // Website www.orthosxxi.com

IICU BEDS

PRIDE PLUS

Pag 19

PRIDE ADVANCE

Pag 24

EUPHORIA

Pag 29

EUPHORIA PLUS LATERALIZATION

Pag 34



PRIDE PLUS



Hospital bed specifically conceived for use in environments with high bacteriological risk, with materials resistant to disinfection. Steel frame with epoxy paint. Articulated bed of 4 planes (fixed pelvic section and 3 articulated sections), in ABS, with holes for ventilation of the mattress. Self-regression of the back section to avoid abdominal compression during the articulation of the bed. Headboards and footboards in ABS, easily detachable. Protection stops in the 4 corners of the bed. 125mm wheels with brake. Electrical articulation of the back and legs. Mechanical rack for the actuation of the

feet section. Mechanical CPR with actuation on both sides of the bed. Emergency battery. Structure prepared for different configurations. It allows to attach different accessories. Compatibility with other equipment (eg hoists). Robust and resistant materials to the disinfection recommended in hospital environment. Available model with fixed height (**PRIDE PLUS**), with bed elevation (**PRIDE PLUS ELEV**) and with elevation, Trendelenburg and reverse (**PRIDE PLUS TREN**). Maximum user weight: 225kg. Safety work load: 310Kg. Possibility of manufacturing by measure.

Features

Robustness and resistance to oxidation

Structure in welded steel tube ST37, with a minimum thickness of 1,5mm. Laser-cut sheets, properly polished and pickled in order to eliminate edges and cutting oxides at the edges.

A 3-step paint process (degreasing, washing and phosphatation), with an ultraviolet resistant epoxy paint finish and with a degree of resistance to salt spray of 1000h (test performed in accordance with ASTM B117 without any visible signs of corrosion). Anti-bacterial paint, resistant to chemical attacks.

ABS bed with high resistance to shock and corrosion. Allows optimal cleaning and disinfection.

Stability

Lifting system (PRIDE PLUS ELEV and PRIDE PLUS TREN) with 4 points of support, by articulated arms - double H - guarantees optimum lateral and longitudinal stability.

Safety

Electrical system with independent motors, in order to minimize impacts and costs in case of failure. Protection against electrocution. Electromagnetic compatibility with electrical and electronic medical equipment. Command with a unique system of protection against rapid and repeated actions of rise / fall, causing damages in the relays, what minimizes potential costs of substitution of commands. Electrical cable with connector to avoid damages by accidental stretching of the same. CPR with actuation on both sides of the bed.

Easy to move

Four-wheel travel system 125mm (other available options, namely central brake with directional wheels and an anti-static wheel). High quality wheels and durability, excellent wear resistance and good oxidation protection. Headboards and footboards with lateral opening to facilitate the driving of the bed.

Comfort and ergonomics

Articulated bed of 4 planes, with auto-regression of the back section to avoid abdominal compression. Extensible 300mm bed to allow maximum comfort for taller users.

Easy cleaning and infection control

Robust and resistant materials to the disinfection recommended in hospital environment. Reduced number of grooves/joints to avoid points of accumulation of waste. Smooth and accessible surfaces. Detachable bed panels for quick and easy cleaning and disinfection.

Functionality

Simple and intuitive user control. Patient command for back, leg, bed lift (PRIDE PLUS ELEV and PRIDE PLUS TREN), Trendelemburg and reverse (PRIDE PLUS TREN). The actuation of the various motors allows several positions such as Fowler and cardiac chair (PRIDE PLUS TREN). Supervisory command allows the mentioned movements as well as electric CPR and lock function.

Configuration

Structure prepared to apply supports in the 4 corners of the bed. Various options and accessories available. Possibility of manufacturing by measure.

ORTHOS XXI, Unipessoal Lda.

Rua Santa Leocádia nº2735 // 4809-012 Sta. Leocádia de Briteiros // Guimarães // Portugal

Phone + 351 253 470 276 // Mobile +351 936 199 005 // Email margarida.silva@orthosxxi.com // Website www.orthosxxi.com

Side rails

Folding universal side rails (option): painted steel or chrome steel.

Bipartite ABS side rails (option): high resistance side rails, individually foldable, through one hand.

Compliance with IEC 60601-2-52.

Compatibility

Compatible with the use of other medical devices such as transfer hoists.

Certification

European product, duly certified. See declaration of conformity and Registration of Infarmed. Meets standards for hospital beds IEC 60601-1; IEC 60601-2-52; IEC 60601-1-11.

Technical data

PRIDE PLUS | PRIDE PLUS ELEV | PRIDE PLUS TREN

Manufacturer: **Orthos XXI** | Reference: 55 CM 3 PR PL | 55 CM 3 PR PL EL | 55 CM 3 PR PL TD

Back section support - inclination angle	70°	Minimum mattress platform height	44,5cm
Legs section support - inclination angle	30°	Maximum mattress platform height	80cm
Trendelenburg and reverse	16°/-16°	Total length	222cm
Mattress platform length	194cm	Overall width	107cm
Mattress platform width	89cm	Maximum user weight	225Kg
Mattress platform extension	30cm	Safe Work load (SWL)	310Kg

Tolerance: +/-1cm

ORTHOS XXI, Unipessoal Lda.

Rua Santa Leocádia n°2735 // 4809-012 Sta. Leocádia de Briteiros // Guimarães // Portugal

Phone + 351 253 470 276 // Mobile +351 936 199 005 // Email margarida.silva@orthosxxi.com // Website www.orthosxxi.com

Configuration and Accessories

Characteristics	PRIDE PLUS	PRIDE PLUS ELEV	PRIDE PLUS TREN
ELEVATOR			
Height adjustable elevator	-	✓	-
Height adjustable elevator, Trendelenburg and reverse	-	-	✓
TYPE OF LEGS (applicable to bed without elevator)			
Double wheels nylon 100mm	○	-	-
Double wheels nylon 125mm	✓	-	-
TYPE OF WHEELS (applicable to bed without elevator)			
Single steel wheels 100mm	-	○	○
Single wheels steel 125mm	-	✓	✓
Double wheels nylon 100mm	-	○	○
Double wheels nylon 125mm	-	○	○
Double Wheels Tente 75-100mm	-	○	○
Double Wheels Tente 100-120mm	-	○	○
Double Wheels Tente 100-150mm	-	○	○
Single steel wheels with center brake 125mm	-	○	○
Double nylon wheels with central brake 125mm	-	○	○
Double nylon wheels with central brake 150mm	-	○	○
5th wheel	-	○	○
HEADBOARDS AND FOOTBOARDS			
ABS headboards/footboards	✓	✓	✓
Headboards/footboards in phenolic resin	○	○	○
Headboards/footboards in phenolic resin/stainless steel	○	○	○
SIDE RAILS			
Universal folding side rails in painted steel	○	○	○
Universal chrome steel folding side rails	○	○	○
Bipartite ABS side rails	○	○	○
COMMANDS			
Patient command	✓	✓	✓
Supervisor (nurse) command	○	○	○
Supervisory (nurse) command - standing	○	○	○
ELECTRICAL FUNCTIONS			
Articulation of back	✓	✓	✓
Articulation of the legs	✓	✓	✓
Hi-Lo	-	✓	✓
Trendelenburg and reverse	-	-	✓
Fowler (2-button combination)	✓	✓	✓
Cardiac chair (3-button combination)	-	-	✓

ORTHOS XXI, Unipessoal Lda.

Rua Santa Leocádia n°2735 // 4809-012 Sta. Leocádia de Briteiros // Guimarães // Portugal

Phone + 351 253 470 276 // Mobile +351 936 199 005 // Email margarida.silva@orthosxxi.com // Website www.orthosxxi.com

Characteristics	PRIDE PLUS	PRIDE PLUS ELEV	PRIDE PLUS TREN
SECURITY FUNCTIONS			
Mechanical CPR	✓	✓	✓
Electric CPR	○	○	○
Self-regression of the back	✓	✓	✓
Self-regression of the legs	○	○	○
Battery	✓	✓	✓
Night light of presence	○	○	○
Brake alarm	○	○	○
Power failure alarm	○	○	○
ENVIRONMENT			
Independent ambient light	○	○	○
Infrared heater	○	○	○
Purifier	○	○	○
RADIOGRAPHY			
Thoracic	○	○	○
Total	○	○	○
RADIOGRAPHY			
Back angle (* included in ABS side rails)	○	○	○
Trend. and reverse angle (* included in ABS side rails)	○	○	○
Independent balance	○	○	○
ACCESSORIES			
Chrome pendant	○	○	○
IV support 2 nylon hooks	○	○	○
IV support 2 stainless steel hooks	○	○	○
IV support 4 stainless steel hooks	○	○	○
IV support with wheels	○	○	○
Urine bag support	○	○	○
Urinal support	○	○	○
Patient identification plate	○	○	○
Clinical file support	○	○	○
Foldable annotation holder	○	○	○
Monitor stand with wheels	○	○	○
Oxygen bottle holder	○	○	○
Fixing for containment systems	○	○	○

"✓": standard feature; "○": option; "-": not applicable

NOTE: in case of divergence between text and image, prevails the information described in the text. For continuous improvement, Orthos XXI reserves the right to make changes to its products without prior notice. More information available in the product manual.

Update: 04/20

ORTHOS XXI, Unipessoal Lda.

Rua Santa Leocádia nº2735 // 4809-012 Sta. Leocádia de Briteiros // Guimarães // Portugal

Phone + 351 253 470 276 // Mobile +351 936 199 005 // Email margarida.silva@orthosxxi.com // Website www.orthosxxi.com

PRIDE ADVANCE



PRIDE ADVANCE, hospital bed specifically designed for use in environments with high bacteriological risk, with materials resistant to disinfection. Steel frame with epoxy paint. Articulated bed of 4 planes (fixed pelvic section and 3 articulated sections), in ABS, with holes for ventilation of the mattress. Self-regression of the back section to avoid abdominal compression during the articulation of the bed. Headboards and footboards in ABS, easily detachable. Protection stops in the 4 corners of the bed. 125mm wheels with brake. Electric articulation of the back and legs by independent motors, through electric control with helical cable. Mechanical rack

for the actuation of the feet section. Bed lift system and functions of Trendelenburg and reverse. Mechanical CPR with actuation on both sides of the bed. Supervisory control with functions of Fowler, semi-Fowler, cardiac chair, auto caregiver and bed output, electric CPR and function lock. Emergency battery. Power failure alarm. Structure prepared for different configurations. It allows to attach different accessories. Compatibility with other equipment (eg hoists). Robust and resistant materials to the disinfection recommended in hospital environment. Fireproof material. Maximum user weight: 225Kg. Safety load: 310Kg. Possibility of manufacturing by measure.

Features

Robustness and resistance to oxidation

Structure in welded steel tube ST37, with a minimum thickness of 1,5mm. Laser-cut sheets, properly polished and pickled in order to eliminate edges and cutting oxides at the edges.

A 3-step paint process (degreasing, washing and phosphatation), with an ultraviolet resistant epoxy paint finish and with a degree of resistance to salt spray of 1000h (test performed in accordance with ASTM B117 without any visible signs of corrosion). Anti-bacterial paint, resistant to chemical attacks.

Easily detachable ABS bed, with high resistance to shock and corrosion. Allows optimal cleaning and disinfection. Sturdy base (for heart massage) with holes for ventilation of the mattress.

Stability

Lifting system with 4 points of support, by articulated arms - double H - guarantees optimal lateral and longitudinal stability.

Safety

Electrical system with independent motors, in order to minimize impacts and costs in case of failure. Emergency battery. Protection against risk of electrocution. Electromagnetic compatibility with electrical and electronic medical equipment. Command with a unique system of protection against rapid and repeated actions of rise / fall, causing damages in the relays, what minimizes potential costs of substitution of commands. Electrical cable with connector to avoid damages by accidental stretching of the same. CPR of the back acting on both sides of the bed.

Easy to move

Four-wheel travel system 125mm (other available options, namely central brake with directional wheels and an anti-static wheel). High quality wheels and durability, excellent wear resistance and good oxidation protection. Use of 5th wheel (optional) to facilitate manoeuvrability. Headboards and footboards with lateral opening to facilitate the driving of the bed.

Comfort and ergonomics

Articulated bed of 4 planes, with auto-regression of the back section to avoid abdominal compression. Extendable 30cm bed to allow maximum comfort for taller users.

Easy cleaning and infection control

Robust and resistant materials to the disinfection recommended in hospital environment. Reduced number of grooves / joints to avoid points of accumulation of waste. Smooth and accessible surfaces. Detachable bed panels for quick and easy cleaning and disinfection.

Functionality

Simple and intuitive user control. Patient command for electrical articulation of the back, legs, bed elevation, Fowler, Trendelenburg and anti-Trendelenburg. Supervisory command allows the mentioned movements as well as electric CPR, cardiac chair, auto caregiver, bed exit and lock functions.

Configuration

Structure prepared to apply supports in the 4 corners of the bed. Various options and accessories available. Possibility of manufacturing by measure.

ORTHOS XXI, Unipessoal Lda.

Rua Santa Leocádia nº2735 // 4809-012 Sta. Leocádia de Briteiros // Guimarães // Portugal

Phone + 351 253 470 276 // Mobile +351 936 199 005 // Email margarida.silva@orthosxxi.com // Website www.orthosxxi.com

Side Rails

Side rails ABS split beams (option). Made of high strength ABS. Easy to clean and disinfect, without holes or points of attachment, to prevent the accumulation of waste and consequent foci of infection. Individually foldable, with one hand.

Compliance with IEC 60601-2-52.

Compatibility

Compatible with the use of other medical devices, such as transfer hoists.

Certification

Product of european manufacture, duly certified. See declaration of conformity and Registration of Infarmed. Meets standards for hospital beds IEC 60601-1; IEC 60601-2-52; IEC 60601-1-11.

Technical data

PRIDE ADVANCE			
Manufacturer: Orthos XXI Reference: 55 CM 3 PR AD RD			
Back section support - inclination angle	70°	Minimum mattress platform height	44,5cm
Legs section support - inclination angle	30°	Maximum mattress platform height	80cm
Trendelemburg and reverse	16°/-16°	Total length	222cm
Mattress platform length	194cm	Overall width (with side rails)	107cm
Mattress platform width	89cm	Maximum user weight	225Kg
Mattress platform extension	30cm	Safe Workload (SWL)	310Kg

Tolerance: +/-1cm

ORTHOS XXI, Unipessoal Lda.

Rua Santa Leocádia nº2735 // 4809-012 Sta. Leocádia de Briteiros // Guimarães // Portugal

Phone + 351 253 470 276 // Mobile +351 936 199 005 // Email margarida.silva@orthosxxi.com // Website www.orthosxxi.com

Configuration and Accessories

Characteristics	PRIDE ADVANCE
TYPE OF WHEELS	
Single wheels steel 125mm	✓
Double wheels nylon 100mm	○
Double wheels nylon 125mm	○
Double Wheels Tente 75-100mm	○
Double Wheels Tente 100-120mm	○
Double Wheels Tente 100-150mm	○
Single steel wheels with center brake 125mm	○
Double nylon wheels with central brake 125mm	○
Double nylon wheels with central brake 150mm	○
5th wheel	○
HEADBOARDS AND FOOTBOARDS	
ABS headboards and footboards	✓
Headboards and footboards in phenolic resin	○
Headboards and footboards in phenolic resin / stainless steel	○
SIDE RAILS	
Universal folding side rails painted steel	○
Universal chrome steel folding side rails	○
ABS Split side rails	○
COMMANDS	
Patient command	✓
Telescopic control	○
Supervisor (nurse) command	✓
Supervisory (nurse) command - standing	○
ELECTRICAL FUNCTIONS	
Articulation of back	✓
Articulation of the legs	✓
Hi-low	✓
Trendelenburg and reverse	✓
Fowler	✓
Semi-Fowler	✓
Cardiac Chair	✓
Attendant/carer auto	✓
Bed output	✓

ORTHOS XXI, Unipessoal Lda.

Rua Santa Leocádia n°2735 // 4809-012 Sta. Leocádia de Briteiros // Guimarães // Portugal

Phone + 351 253 470 276 // Mobile +351 936 199 005 // Email margarida.silva@orthosxxi.com // Website www.orthosxxi.com

Characteristics	PRIDE ADVANCE
SECURITY FUNCTIONS	
Mechanical CPR	✓
Electric CPR	✓
Self-regression of the back	✓
Self-regression of the legs	○
Battery	✓
Night light of presence	○
Brake alarm	○
Power failure alarm	✓
ENVIRONMENT	
Independent ambient light	○
Infrared heater	○
Purifier	○
RADIOGRAPHY	
Thoracic	○
Total	○
MEASUREMENT	
Back angle (* included in ABS side rails)	○
Trend. and reverse angle (* included in ABS side rails)	○
Independent balance	○
ACCESSORIES	
Chrome pendant	○
IV support 2 nylon hooks	○
IV support 2 stainless steel hooks	○
IV support 4 stainless steel hooks	○
IV support with wheels	○
Urine bag support	○
Urinal Support	○
Patient identification plate	○
Clinical file support	○
Foldable annotation holder	○
Monitor stand with wheels	○
Oxygen bottle holder	○
Fixing for containment systems	○
Drawer for supervisor control	○
Support for traction systems	○

"✓": standard feature; "○": option; "-": not applicable

NOTE: in case of divergence between text and image, prevails the information described in the text. For continuous improvement, Orthos XXI reserves the right to make changes to its products without prior notice. More information available in the product manual.

Update: 08/20

ORTHOS XXI, Unipessoal Lda.

Rua Santa Leocádia nº2735 // 4809-012 Sta. Leocádia de Briteiros // Guimarães // Portugal

Phone + 351 253 470 276 // Mobile +351 936 199 005 // Email margarida.silva@orthosxxi.com // Website www.orthosxxi.com

EUPHORIA



Hospital bed specifically designed for use in environments with high bacteriological risk, such as intensive care units, with materials resistant to disinfection. Steel frame with epoxy paint. Articulated bed of 4 planes (fixed pelvic section and 3 articulated sections), in ABS, with holes for ventilation of the mattress. Self-regression of the back section to avoid abdominal compression during the joint of the bed. Headboards and footboards in ABS, easily detachable. Protection stops in the 4 corners of the bed. 125mm wheels with brake. Electric articulation of the back and legs by independent motors, through electric control with helical cable. Mechanical rack for the actuation of the feet section.

Columns bed lift system and functions of Trendelenburg and reverse. Mechanical and electrical CPR. Supervisory control with functions of Fowler, semi-Fowler, cardiac chair, auto caregiver and bed output and function lock. Emergency battery. Power failure alarm. Structure prepared for different configurations. It allows to attach different accessories. Compatibility with other equipment (eg hoists). Robust and resistant materials to the disinfection recommended in hospital environment. Available configurations: *EUPHORIA BASIC*, *EUPHORIA PLUS* and *EUPHORIA PLUS COMMAND SIDE RAILS*. Maximum user weight: 250 kg. Safety load: 335Kg. Possibility of manufacturing by measure.

Features

Robustness and resistance to oxidation

Structure in welded steel tube ST37, with a minimum thickness of 1,5mm. Laser-cut sheets, properly polished and pickled in order to eliminate edges and cutting oxides at the edges.

A 3-step paint process (degreasing, washing and phosphatation), with an ultraviolet resistant epoxy paint finish and with a degree of resistance to salt spray of 1000h (test performed in accordance with ASTM B117 without any visible signs of corrosion). Anti-bacterial paint, resistant to chemical attacks.

Easily detachable ABS bed, with high resistance to shock and corrosion. Allows optimal cleaning and disinfection. Sturdy base (for heart massage) with holes for ventilation of the mattress.

Stability

Lifting system through independent columns guarantees optimal lateral and longitudinal stability, as well as robustness and equipment durability.

Safety

Electrical system with independent motors, in order to minimize impacts and costs in case of failure. Emergency battery. Protection against risk of electrocution. Electromagnetic compatibility with electrical and electronic medical equipment. Command with a unique system of protection against rapid and repeated actions of rise / fall, causing damages in the relays, what minimizes potential costs of substitution of commands. Electrical cable with connector to avoid damages by accidental stretching of the same. CPR of the back acting on both sides of the bed.

Easy to move

125mm wheels with brake (other options available). High quality wheels and durability, excellent wear resistance and good oxidation protection. Use of 5th wheel (optional) to facilitate manoeuvrability. Headboards and footboards with lateral opening to facilitate the driving of the bed.

Comfort and ergonomics

Articulated bed of 4 planes, with auto-regression of the back section to avoid abdominal compression. Extendable 30cm bed to allow maximum comfort for taller users.

Easy cleaning and infection control

Robust and resistant materials to the disinfection recommended in hospital environment. Reduced number of grooves / joints to avoid points of accumulation of waste. Smooth and accessible surfaces. Detachable bed panels for quick and easy cleaning and disinfection.

Functionality

Simple and intuitive user control. Patient command for electrical articulation of the back, legs, bed elevation, Fowler, Trendelenburg and anti-Trendelenburg. Supervisory command allows the mentioned movements as well as electric CPR, cardiac chair, auto caregiver, bed exit and lock functions.

Configuration

Structure prepared to apply supports in the 4 corners of the bed. Various options and accessories available. Possibility of manufacturing by measure.

ORTHOS XXI, Unipessoal Lda.

Rua Santa Leocádia nº2735 // 4809-012 Sta. Leocádia de Briteiros // Guimarães // Portugal

Phone + 351 253 470 276 // Mobile +351 936 199 005 // Email margarida.silva@orthosxxi.com // Website www.orthosxxi.com

Side Rails

Side rails ABS split beams (option in model EUPHORIA BASIC). Made of high strength ABS. Easy to clean and disinfect, without holes or points of attachment, to prevent the accumulation of waste and consequent foci of infection. Individually foldable, with one hand. With integrated control on the side rails. Compliance with IEC 60601-2-52.

Compatibility

Compatible with the use of other medical devices, such as transfer hoists.

Certification

Product of national manufacture, duly certified. See declaration of conformity and Registration of Infarmed. Meets standards for hospital beds IEC 60601-1; IEC 60601-2-52; IEC 60601-1-11.



Euphoria Plus with command on side rails

Technical data

EUPHORIA BASIC | EUPHORIA PLUS | EUPHORIA PLUS COMANDO GRADES

Manufacturer: Orthos XXI | Reference: 55 CM 3 EU BS | 55 CM 3 EU PL | 55 CM 3 EU PL CG

Back section support - inclination angle	70°	Bed lifting range	400mm
Legs section support - inclination angle	30°	Total length	2210mm
Trendelenburg and reverse	16°/-16°	Overall width	1060mm
Mattress platform length	1990mm	Maximum user weight	250Kg
Mattress platform width	890mm	Safe Work Load (SWL)	335Kg
Mattress platform extension	300mm		

Tolerance: +/-1cm

ORTHOS XXI, Unipessoal Lda.

Rua Santa Leocádia n°2735 // 4809-012 Sta. Leocádia de Briteiros // Guimarães // Portugal

Phone + 351 253 470 276 // Mobile +351 936 199 005 // Email margarida.silva@orthosxxi.com // Website www.orthosxxi.com

Configuration and Accessories

Characteristics	EUPHORIA BASIC	EUPHORIA PLUS	EUPHORIA PLUS CMD SIDE RAILS
TYPE OF WHEELS			
Single steel wheels 125mm	✓	-	-
Double nylon wheels 100mm	○	-	-
Double nylon wheels 125mm	○	-	-
Double wheels Tente 75-100mm	○	-	-
Double wheels Tente 100-120mm	○	-	-
Double wheels Tente 100-150mm	○	○	○
Single steel wheel with central brake 125mm	○	○	○
Double wheels with central brake 125mm	○	✓	✓
Double wheels with central brake 150mm	○	○	○
5th wheel	○	○	○
HEADBOARDS AND FOOTBOARDS			
ABS headboards and footboards	✓	✓	✓
SIDE RAILS			
ABS Split side rails	○	✓	-
ABS Split side rails with integrated control	-	-	✓
COMMANDS			
Patient command	✓	✓	✓
Telescopic control	○	○	○
Supervisor (nurse) command	✓	✓	✓
Supervisor (nurse) command – foot control	○	○	○
ELECTRICAL FUNCTIONS			
Articulation of back	✓	✓	✓
Articulation of the legs	✓	✓	✓
Hi-low	✓	✓	✓
Trendelenburg and reverse	✓	✓	✓
Fowler	✓	✓	✓
Semi-Fowler	✓	✓	✓
Cardiac Chair	✓	✓	✓
Attendant auto	✓	✓	✓
Out of bed	✓	✓	✓
SECURITY FUNCTIONS			
Mechanical CPR	✓	✓	✓
Electric CPR	✓	✓	✓
Self-regression of the back	✓	✓	✓

ORTHOS XXI, Unipessoal Lda.

Rua Santa Leocádia n°2735 // 4809-012 Sta. Leocádia de Briteiros // Guimarães // Portugal

Phone + 351 253 470 276 // Mobile +351 936 199 005 // Email margarida.silva@orthosxxi.com // Website www.orthosxxi.com

Características	EUPHORIA BASIC	EUPHORIA PLUS	EUPHORIA PLUS CMD SIDE RAILS
Self-regression of the legs	○	○	○
Battery	✓	✓	✓
Night light of presence	○	○	○
Brake alarm	○	○	○
Power failure alarm	✓	✓	✓
ENVIRONMENT			
Independent ambient light	○	○	○
Infrared heater	○	○	○
Purifier	○	○	○
RADIOGRAPHY			
Thoracic	○	○	○
Total	○	○	○
MEASUREMENT			
Back angle (* included in ABS side rails)	○	○	○
Trend. and reverse angle (* included in ABS side rails)	○	○	○
Independent balance	○	○	○
ACCESSORIES			
Chrome pendant	○	○	○
IV support 2 nylon hooks	○	○	○
IV support 2 stainless steel hooks	○	○	○
IV support 4 stainless steel hooks	○	○	○
IV support with wheels	○	○	○
Urine bag support	○	○	○
Urinal Support	○	○	○
Patient identification plate	○	○	○
Clinical file support	○	○	○
Foldable annotation holder	○	○	○
Monitor stand with wheels	○	○	○
Oxygen bottle holder	○	○	○
Fixing for containment systems	○	○	○
Drawer for supervisor control	○	✓	✓
Support for traction systems	○	○	○

"✓": standard feature; "○": option; "-": not applicable

NOTE: in case of divergence between text and image, prevails the information described in the text. For continuous improvement, Orthos XXI reserves the right to make changes to its products without prior notice. More information available in the product manual.

Update: 08/19

ORTHOS XXI, Unipessoal Lda.

Rua Santa Leocádia nº2735 // 4809-012 Sta. Leocádia de Briteiros // Guimarães // Portugal

Phone + 351 253 470 276 // Mobile +351 936 199 005 // Email margarida.silva@orthosxxi.com // Website www.orthosxxi.com

EUPHORIA PLUS LATERALIZATION



Hospital bed specifically designed for use in environments with high bacteriological risk, such as intensive care units, with materials resistant to disinfection. With lateralization function, it helps to prevent pulmonary complications and facilitates the drainage process. Steel frame with epoxy paint. Articulated bed of 4 planes (fixed pelvic section and 3 articulated sections), in ABS, with holes for ventilation of the mattress. Self-regression of the back section to avoid abdominal compression during the joint of the bed. Headboards and footboards in ABS, easily detachable. Protection stops in the 4 corners of the bed. 150mm wheels with central brake. Electric articulation of the back and legs by independent motors, through electric control with helical cable.

Mechanical rack for the actuation of the feet section. Columns bed lift system and functions of Trendelenburg and reverse. Mechanical and electrical CPR. Supervisory control with functions of Fowler, semi-Fowler, cardiac chair, auto caregiver and bed output, lateralization and function lock. The lateralization movements occur in automatic cycles of 30 minutes with an amplitude of 15°. Emergency battery. Power failure alarm. Structure prepared for different configurations. It allows to attach different accessories. Compatibility with other equipment (eg hoists). Robust and resistant materials to the disinfection recommended in hospital environment. Maximum user weight: 250 kg. Safety load: 335Kg. Possibility of manufacturing by measure.

Features

Robustness and resistance to oxidation

Structure in welded steel tube ST37, with a minimum thickness of 1,5mm. Laser-cut sheets, properly polished and pickled in order to eliminate edges and cutting oxides at the edges.

A 3-step paint process (degreasing, washing and phosphatation), with an ultraviolet resistant epoxy paint finish and with a degree of resistance to salt spray of 1000h (test performed in accordance with ASTM B117 without any visible signs of corrosion). Anti-bacterial paint, resistant to chemical attacks.

Easily detachable ABS bed, with high resistance to shock and corrosion. Allows optimal cleaning and disinfection. Sturdy base (for heart massage) with holes for ventilation of the mattress.

Stability

Lifting system through independent columns guarantees optimal lateral and longitudinal stability, as well as robustness and equipment durability.

Safety

Electrical system with independent motors, in order to minimize impacts and costs in case of failure. Emergency battery. Protection against risk of electrocution. Electromagnetic compatibility with electrical and electronic medical equipment. Command with a unique system of protection against rapid and repeated actions of rise / fall, causing damages in the relays, what minimizes potential costs of substitution of commands. Electrical cable with connector to avoid damages by accidental stretching of the same. CPR of the back acting on both sides of the bed.

Easy to move

150mm wheels with central brake with directional wheels and an anti-static wheel. High quality wheels and durability, excellent wear resistance and good oxidation protection. Use of 5th wheel (optional) to facilitate manoeuvrability. Headboards and footboards with lateral opening to facilitate the driving of the bed.

Comfort and ergonomics

Articulated bed of 4 planes, with auto-regression of the back section to avoid abdominal compression. Extendable 300mm bed to allow maximum comfort for taller users.

Easy cleaning and infection control

Robust and resistant materials to the disinfection recommended in hospital environment. Reduced number of grooves / joints to avoid points of accumulation of waste. Smooth and accessible surfaces. Detachable bed panels for quick and easy cleaning and disinfection.

Functionality

Simple and intuitive user control. Patient command for electrical articulation of the back, legs, bed elevation, Fowler, Trendelenburg and anti-Trendelenburg. Supervisory command allows the mentioned movements as well as electric CPR, cardiac chair, auto caregiver, bed exit and lock functions.

Configuration

Structure prepared to apply supports in the 4 corners of the bed. Various options and accessories available. Possibility of manufacturing by measure.

ORTHOS XXI, Unipessoal Lda.

Rua Santa Leocádia nº2735 // 4809-012 Sta. Leocádia de Briteiros // Guimarães // Portugal

Phone + 351 253 470 276 // Mobile +351 936 199 005 // Email margarida.silva@orthosxxi.com // Website www.orthosxxi.com

Side Rails

Side rails ABS split beams (option). Made of high strength ABS. Easy to clean and disinfect, without holes or points of attachment, to prevent the accumulation of waste and consequent foci of infection. Individually foldable, with one hand. With integrated control on the side rails.

Compliance with IEC 60601-2-52.

Compatibility

Compatible with the use of other medical devices, such as transfer hoists.

Certification

Product of national manufacture, duly certified. See declaration of conformity and Registration of Infarmed. Meets standards for hospital beds IEC 60601-1; IEC 60601-2-52; IEC 60601-1-11.

Technical data

EUPHORIA PLUS LATERALIZATION

Manufacturer: Orthos XXI | Reference: 55 CM 3 EU LT

Back section support - inclination angle	70°	Mattress platform width	890mm
Legs section support - inclination angle	30°	Bed lifting range	400mm
Trendelemburg and reverse	15°/-15°	Total length	2210mm
Lateralization	15°	Overall width	1060mm
Mattress platform length	1990mm	Maximum user weight	250Kg
Mattress platform extension	300mm	Safe Work Load (SWL)	335Kg

Tolerance: +/-1cm

ORTHOS XXI, Unipessoal Lda.

Rua Santa Leocádia n°2735 // 4809-012 Sta. Leocádia de Briteiros // Guimarães // Portugal

Phone + 351 253 470 276 // Mobile +351 936 199 005 // Email margarida.silva@orthosxxi.com // Website www.orthosxxi.com

Configuration and Accessories

Characteristics	PRIDE ADVANCE
TYPE OF WHEELS	
Single steel wheels with central brake 125mm	<input type="radio"/>
Double nylon wheels with central brake 125mm	<input type="radio"/>
Double nylon wheels with central brake 150mm	<input checked="" type="checkbox"/>
Double nylon wheels with central brake 200mm	<input type="radio"/>
5th wheel	<input type="radio"/>
HEADBOARDS AND FOOTBOARDS	
ABS headboards and footboards	<input checked="" type="checkbox"/>
SIDE RAILS	
ABS Split side rails with integrated control	<input type="radio"/>
COMMANDS	
Patient command	<input checked="" type="checkbox"/>
Telescopic control	<input type="radio"/>
Supervisor (nurse) command	<input checked="" type="checkbox"/>
ELECTRICAL FUNCTIONS	
Articulation of back	<input checked="" type="checkbox"/>
Articulation of the legs	<input checked="" type="checkbox"/>
Hi-low	<input checked="" type="checkbox"/>
Trendelenburg and reverse	<input checked="" type="checkbox"/>
Fowler	<input checked="" type="checkbox"/>
Semi-Fowler	<input checked="" type="checkbox"/>
Cardiac Chair	<input checked="" type="checkbox"/>
Attendant auto	<input checked="" type="checkbox"/>
Out of bed	<input checked="" type="checkbox"/>
Lateralization	<input checked="" type="checkbox"/>
SECURITY FUNCTIONS	
Mechanical CPR	<input checked="" type="checkbox"/>
Electric CPR	<input checked="" type="checkbox"/>
Self-regression of the back	<input checked="" type="checkbox"/>
Self-regression of the legs	<input type="radio"/>
Battery	<input checked="" type="checkbox"/>
Night light of presence	<input type="radio"/>
Brake alarm	<input type="radio"/>
Power failure alarm	<input checked="" type="checkbox"/>

ORTHOS XXI, Unipessoal Lda.

Rua Santa Leocádia n°2735 // 4809-012 Sta. Leocádia de Briteiros // Guimarães // Portugal

Phone + 351 253 470 276 // Mobile +351 936 199 005 // Email margarida.silva@orthosxxi.com // Website www.orthosxxi.com

Characteristics	PRIDE ADVANCE
ENVIRONMENT	
Independent ambient light	○
Infrared heater	○
Purifier	○
RADIOGRAPHY	
Thoracic	○
Total	○
MEASUREMENT	
Back angle (* included in ABS side rails)	○
Trend. and reverse angle (* included in ABS side rails)	○
Independent balance	○
ACCESSORIES	
Chrome pendant	○
IV support 2 nylon hooks	○
IV support 2 stainless steel hooks	○
IV support 4 stainless steel hooks	○
IV support with wheels	○
Urine bag support	○
Urinal Support	○
Patient identification plate	○
Clinical file support	○
Foldable annotation holder	○
Monitor stand with wheels	○
Oxygen bottle holder	○
Fixing for containment systems	○
Drawer for supervisor control	✓
Support for traction systems	○

"✓": standard feature; "○": option; "-": not applicable

NOTE: in case of divergence between text and image, prevails the information described in the text. For continuous improvement, Orthos XXI reserves the right to make changes to its products without prior notice. More information available in the product manual.

Update: 08/19

ORTHOS XXI, Unipessoal Lda.

Rua Santa Leocádia nº2735 // 4809-012 Sta. Leocádia de Briteiros // Guimarães // Portugal

Phone + 351 253 470 276 // Mobile +351 936 199 005 // Email margarida.silva@orthosxxi.com // Website www.orthosxxi.com

BEDSIDE CABINETS

BEDSIDE TABLE PHENOLIC	Pag 40
BEDSIDE TABLE ABS	Pag 41
METALLIC BEDSIDE TABLE	Pag 43
OVERBED TABLE HPL	Pag 44
OVERBED TABLE ABS	Pag 45



BEDSIDE TABLE PHENOLIC



Designed for hospital use in environments with high bacteriological risk. Easy cleaning and disinfection structure with rounded

corners, no edges. Made in HPL (phenolic compact). Robust and durable structure. With four wheels, two with brakes.

Technical data

BEDSIDE TABLE PHENOLIC

Manufacturer: Orthos XXI | Reference: 55 ME 3 CL CB 1F RS

Width	42cm	Height	63cm
Depth	39cm		

Tolerance: +/-1cm

NOTE: in case of divergence between text and image, prevails the information described in the text. For continuous improvement, Orthos XXI reserves the right to make changes to its products without prior notice. More information available in the product manual.

Update: 04/20

ORTHOS XXI, Unipessoal Lda.

Rua Santa Leocádia n°2735 // 4809-012 Sta. Leocádia de Briteiros // Guimarães // Portugal

Phone + 351 253 470 276 // Mobile +351 936 199 005 // Email margarida.silva@orthosxxi.com // Website www.orthosxxi.com

BEDSIDE TABLE ABS



Designed for hospital use in environments with high bacteriological risk. Easy cleaning and disinfection structure with rounded corners, no edges. Upper and lateral structure in ABS, with doors and drawers in phenolic resin. With drawer and cupboard with bottom shelf, the bottom is ventilated to evacuate odors. Top cup holder. Top tray with anti-spill collar, adjustable in height and swivel. With four wheels, two with brakes.

Shock protection stops in the 4 corners of the table. Depending on the configuration selected, the table can have single front or double front. The double front allows access to the drawer and cabinet on both sides, and can be used to the left or right of the bed. The bedside table can be purchased independently from the bed board or, alternatively, as a single structure. Collapsible tray (optional).

Features



Robustness

Steel, ABS and phenolic structure



Storage

With door and drawer with shelf



Control of infection

Materials resistant to disinfection recommended in hospital



Configuration

Available with or without attached tray

Technical data

BEDSIDE TABLE ABS

Manufacturer: Orthos XXI | Reference: 55 ME 3 CB 2F ABS

Width without stops	560mm	Minimum height with tray	940mm
Width with stops	605mm	Maximum height with tray	1190mm
Depth	480mm	Depth with tray	650mm
Height	810mm	Tray width	400mm

Tolerance: +/-1cm

NOTE: in case of divergence between text and image, prevails the information described in the text. For continuous improvement, Orthos XXI reserves the right to make changes to its products without prior notice. More information available in the product manual.

Update: 01/19

ORTHOS XXI, Unipessoal Lda.

Rua Santa Leocádia n°2735 // 4809-012 Sta. Leocádia de Briteiros // Guimarães // Portugal

Phone + 351 253 470 276 // Mobile +351 936 199 005 // Email margarida.silva@orthosxxi.com // Website www.orthosxxi.com

METALLIC BEDSIDE TABLE



Metallic bedside tables with structure in steel, with epoxy paint. Wood top coated with thermolaminat. With rubber toe pads. Available in 3 models: small bedside table with cabinet and drawer; large bedside

table with closet, drawer, magazine rack, bottle holder and towel rack and large bedside table with cupboard, 2 drawers, magazine rack, bottle holder and towel rack.

Technical data

BEDSIDE TABLE SMALL LARGE 1 DRAWER LARGE 2 DRAWERS			
Reference: 55 ME 3 CA PQ 55 ME 3 CA GR 1G 55 ME 3 CA GR 2G			
	SMALL	LARGE 1 DRAWER	LARGE 2 DRAWERS
Dimensions	340x350x720mm	430x360x860mm	400x420x810mm
Weight	10Kg	18Kg	20Kg

Tolerance: +/-1cm

NOTE: in case of divergence between text and image, prevails the information described in the text. For continuous improvement, Orthos XXI reserves the right to make changes to its products without prior notice. More information available in the product manual.

Update: 01/19

ORTHOS XXI, Unipessoal Lda.

Rua Santa Leocádia nº2735 // 4809-012 Sta. Leocádia de Briteiros // Guimarães // Portugal

Phone + 351 253 470 276 // Mobile +351 936 199 005 // Email margarida.silva@orthosxxi.com // Website www.orthosxxi.com

OVERBED TABLE HPL



OVERBED TABLE, design for use in environments with high bacteriological risk, with materials resistant to disinfection. Steel

frame with epoxy paint, adjustable in height. Tray in HPL, adjustable in inclination. Four wheels, two with brakes.

Technical data

OVERBED TABLE HPL			
Manufacturer: Orthos XXI Referende: 55 ME 3 CL SP RE RS			
Tray length	60cm	Total width	43cm
Tray width	40cm	Minimum height	80cm
Total length	76cm	Maximum height	100cm

Tolerance: +/-1cm

NOTE: in case of divergence between text and image, prevails the information described in the text. For continuous improvement, Orthos XXI reserves the right to make changes to its products without prior notice. More information available in the product manual.

Update: 04/20

ORTHOS XXI, Unipessoal Lda.

Rua Santa Leocádia nº2735 // 4809-012 Sta. Leocádia de Briteiros // Guimarães // Portugal

Phone + 351 253 470 270/1/2/3/4 // Email info@orthosxxi.com // Website www.orthosxxi.com

OVERBED TABLE ABS



OVERBED TABLE, design for use in environments with high bacteriological risk, with materials resistant to disinfection. Steel

frame with epoxy paint, adjustable in height. Tray in HPL, adjustable in inclination. Four wheels, two with brakes.

Technical data

OVERBED TABLE ABS

Manufacturer: Orthos XXI

Length	750mm
Width	400mm
Height	835-1145mm

Tolerance: +/-1cm

NOTE: in case of divergence between text and image, prevails the information described in the text. For continuous improvement, Orthos XXI reserves the right to make changes to its products without prior notice. More information available in the product manual.

Update: 04/20

ORTHOS XXI, Unipessoal Lda.

Rua Santa Leocádia nº2735 // 4809-012 Sta. Leocádia de Briteiros // Guimarães // Portugal
Phone + 351 253 470 270/1/2/3/4 // Email info@orthosxxi.com // Website www.orthosxxi.com

TRANSPORT CHAIRS

ORIENTAL

Pag 47



ORIENTAL



ORIENTAL, reclining chair designed for use in a clinical, hospital and institutional environment in general, so as to provide a comfortable seating for patients and companions. With a robust and resistant in steel tube 30x1,5mm in the base and 22x1,25mm in the backrest. Backrest with lumbar reinforcement allows to accompany the lumbar curvature, promoting a greater support and consequent sensation of comfort. Reclining backrest up to 155°

through 500N gas actuator. Lifting feet support through 200N gas actuator. It supports arms adjustable in height to the height of the seat facilitating the patient in and out of the chair, as well as the lateral transfers. 125mm wheels with brake system on two wheels. Vinyl screen upholstery with a wide range of colors available. Several options available: concave armrests, serum support, centralized brake system, etc.

Features



Comfort

Backrest recline and leg elevation independently



Mobility

Robust 125mm wheels and easy-to-move grips



Transfer

Armrests adjustable up to seat level for easy access



Customization

Possibility of selecting a wide range of colors

Technical data

ORIENTAL

Manufacturer: Orthos XXI | Reference: 55 SF N OR

Seat Width	520mm	Backrest height	780mm
Total width	650mm	Distance from seat to floor	550mm
Seat depth	460mm	Reclining backrest	155°
Total Depth	510mm	Maximum user weight	180Kg

Tolerance: +/-1cm

NOTE: in case of divergence between text and image, prevails the information described in the text. For continuous improvement, Orthos XXI reserves the right to make changes to its products without prior notice. More information available in the product manual.

Update: 12/19

ORTHOS XXI, Unipessoal Lda.

Rua Santa Leocádia nº2735 // 4809-012 Sta. Leocádia de Briteiros // Guimarães // Portugal

Phone + 351 253 470 276 // Mobile +351 936 199 005 // Email margarida.silva@orthosxxi.com // Website www.orthosxxi.com

COUCHES

EXAMINATION COUCH VICTORY

Pag 50

EXAMINATION COUCH VICTORY ELEC-
TRIC/HYDRAULIC

Pag 52

EXAMINATION TABLES

Pag 54



EXAMINATION COUCH VICTORY



VICTORY, examination couch conceived for observation and treatment. With bipartite structure in painted steel with epoxy paint finish. Removable for easy storage. Fixed height in 3 positions, by adjusting the position

of the legs. Padded bed in foam coated with Medical upholstery. Articulated headboard with hole for face placement. With paper roll holder. Upholstery available in various colours.

Features



Resistance

Steel frame with epoxy paint finish



Comfort

Bipartite bed with hole for face placement



Configuration

Upholstery available in various colours (check availability)

Technical data

EXAMINATION COUCH VICTORY

Manufacturer: Orthos XXI | Reference: 55 MQ 3 DE AR AL

Length	1850mm	Height	600-680-730mm
Width	580mm	Maximum user weight	100Kg

Tolerance: +/-1cm

NOTE: in case of divergence between text and image, prevails the information described in the text. For continuous improvement, Orthos XXI reserves the right to make changes to its products without prior notice. More information available in the product manual.

Update: 03/19

ORTHOS XXI, Unipessoal Lda.

Rua Santa Leocádia nº2735 // 4809-012 Sta. Leocádia de Briteiros // Guimarães // Portugal

Phone + 351 253 470 276 // Mobile +351 936 199 005 // Email margarida.silva@orthosxxi.com // Website www.orthosxxi.com

EXAMINATION COUCH VICTORY

ELECTRIC/HYDRAULIC



EXAMINATION COUCH VICTORY, with bipartite structure in steel with epoxy paint finish. Practical and robust, it is a great option for use in physiotherapy clinics and gyms, for observation and treatment of users. Adjustable in height, from 400 to 800mm, it facilitates the user's climb to the examination couch, as well as the ergonomics of the caregiver. The height adjustment can be done in two ways: hydraulic, through pedal,

or electric, through intuitive use command. Quilted PU foam bed and memory foam coated with high strength vinyl fabric (available in various colors). Articulated headboard through pneumatic system. Contains paper roll holder. It has two fixed feet and two castors with brakes; this system facilitates the movement of the examination couch in occasional small offices.

Features



Height adjustable
Hydraulic or electric



Headboard Joint
Per handle, pneumatic system



Roll paper holder
with Allows easy and fast placement of paper roll



Customization
Possibility of selecting a wide range of colours

Technical data

EXAMINATION COUCH VICTORY ELECTRIC/HYDRAULIC

Manufacturer: **Orthos XXI** | Reference: 55 MQ 3 EL EL | 55 MQ 3 EL HD

Length	1850mm	Single wheels (hydraulic model)	100mm
Width	580mm	Double wheels (electric model)	75mm
Minimum height	400mm	Max user weight	100Kg
Maximum height	800mm		

Tolerance: +/-1cm

NOTE: in case of divergence between text and image, prevails the information described in the text. For continuous improvement, Orthos XXI reserves the right to make changes to its products without prior notice. More information available in the product manual.

Update: 02/19

ORTHOS XXI, Unipessoal Lda.

Rua Santa Leocádia n°2735 // 4809-012 Sta. Leocádia de Briteiros // Guimarães // Portugal

Phone + 351 253 470 276 // Mobile +351 936 199 005 // Email margarida.silva@orthosxxi.com // Website www.orthosxxi.com

EXAMINATION TABLES



Gynecological couch

Practical and functional, can be used as gynecological or as observation couch (2 in 1). Structure in square steel structure, epoxy painting/Stainless steel, upholstered bed in foam and napa, adjustable backrest, head and leg support, with fixation system at various positions, thighs support in foam, paper roll holder.

Dimensions: 215x58x56-87cm



Gynecology and obstetrics examination table

55 MQ 3 GI PT DG

Structure in square steel structure, epoxy painting/Stainless steel, upholstered bed in foam and napa, with two trays, one for waste and another for instruments, adjustable backrest and leg support, with fixation system at various positions, thighs support in nylon fiber, collapsible step and tabletop in laminate, adaptation for paper roll holder.

Dimensions: 180x50x85cm



Gynecology and obstetrics examination table with 5 drawers
55 MQ 3 GI GV

Metal frame, epoxy painting, stainless steel footer, articulated upholstered bed with the headboard in relief, two drawers, three on the sides in laminitis, container for liquids, collapsible step for better access, incorporated, paper roll support, set of nylon fibre leggings, with set of stirrups.

Dimensions: 183x82x69cm



Gynecology and obstetrics examination table with elevator
55 MQ 3 GI EL

Structure in steel plate, upholstered bed in foam and napa with 3 sections, being them articulated. Seat elevation by manual system. Headboard and foot articulation by gas damper system. Thighs support in nylon fiber. Arms support in napa coated. 62cm/82cm electrical elevation with foot control.

Dimensions: 185x65cm

NOTE: in case of divergence between text and image, prevails the information described in the text. For continuous improvement, Orthos XXI reserves the right to make changes to its products without prior notice. More information available in the product manual.

Update: 03/18

ORTHOS XXI, Unipessoal Lda.

Rua Santa Leocádia nº2735 // 4809-012 Sta. Leocádia de Briteiros // Guimarães // Portugal

Phone + 351 253 470 276 // Mobile +351 936 199 005 // Email margarida.silva@orthosxxi.com // Website www.orthosxxi.com

STRETCHERS

HYDRAULIC TRANSPORTATION STRETCHER

Pag 57

STRETCHER

Pag 59



HYDRAULIC TRANSPORTATION STRETCHER



HYDRAULIC TRANSPORT STRETCHER, designed for use in institutional and hospital environments, for observation and treatment. Promotes caregiver ergonomics and facilitates user access. Built in steel with epoxy paint finish resistant to ultraviolet rays and with a degree of resistance to salt spray of 1000h (test carried out in accordance with ASTM B117 without any visible sign of corrosion). Bipartite bed in a phenolic compact, operated by gas pumps. Height adjustment by scissor system, with hydraulic actuators, pedal operated, on both sides of the stretcher, approx. from 40cm to 80cm.

Version with Trendelemburg and hydraulic anti-Trendelemburg operated by handle is also available. Driving bars at both ends of the stretcher for easy handling. Protection stops in the 4 corners. Folding side rails. Protection stops in the 4 corners. Serum support. Oxygen bottle holder. Mattress with bielastic cover impermeable to liquids and permeable to gauze, with straps for better attachment to the bed. Cover with flameproof protection, according to BS 7175 1989, Crib 5. Resistant to the recommended disinfections in a hospital environment.

Features



Robustness

Steel structure with phenolic compact bed

Regulation

Back section articulation, height adjustment (also available with Trendelemburg and reverse model)

Comfort

Mattress with liquid-impermeable and gas-permeable bielastic cover

Technical data

HYDRAULIC TRANSPORTATION STRETCHER | Trendelemburg

Manufacturer: Orthos XXI | Reference: 55 MC 3 HD BI | 55 MC 3 HD TD BI

Bed length	1900mm	Mattress material	PU
Bed width	650mm	Mattress thickness	80mm
Total length	2100mm	Waterproof cover	Blue
Overall width	800mm	Maximum user weight	150Kg
Trendelenburg and reverse	16°/-16°		

Tolerance: +/-1cm

NOTE: in case of divergence between text and image, prevails the information described in the text. For continuous improvement, Orthos XXI reserves the right to make changes to its products without prior notice. More information available in the product manual.

Update: 04/20

ORTHOS XXI, Unipessoal Lda.

Rua Santa Leocádia nº2735 // 4809-012 Sta. Leocádia de Briteiros // Guimarães // Portugal

Phone + 351 253 470 276 // Mobile +351 936 199 005 // Email margarida.silva@orthosxxi.com // Website www.orthosxxi.com

STRETCHER



Designed for use in hospital and institutional environment, for observation and treatment. It promotes the ergonomics of the caregiver and facilitates the access of the user. Constructed of steel with epoxy paint resistant to ultraviolet rays and with a degree of resistance to saline fog of 1000h (test performed in accordance with ASTM B117 without any visible signs of corrosion). Bipartite (or tripartite) bed in phenolic compact, radiotransparent, operated by gas pumps. Height adjustment by hydraulic columns, pedal operated, on both sides of the stretcher, from 50cm to 90cm. Trendelenburg and reverse hydraulically

actuated by double pedal, on both sides of the stretcher. Driving bars on both ends for easy handling. Stainless steel folding side rails. Protection ends in the 4 corners. Serum holder with stainless steel hooks. Oxygen bottle holder and belongings/clothing support in stainless steel. Central brake with 200mm directional wheels and 1 anti-static wheel. Anti-static mattress with 80mm thickness, with bielastic cover impermeable to liquids and permeable to gazes, with straps for better attachment to the bed. Fireproof cover, according to BS 7175 1989, Crib 5. Resistant to the recommended disinfection in hospital environment.

Features



Base in phenolic compact

Available in bipartite or tripartite version, actuated with gas pump



Trendelenburg and reverse

Actuated through double pedal, located on both sides of the stretcher



Comfort

Anti-static mattress with 80mm height, with bielastic and waterproof cover

Technical data

COLUMNS TRANSPORT STRETCHER BIPARTITE | TRIPARTITE

Manufacturer: Orthos XXI | Reference: 55 MC 3 TD BI | 55 MC 3 TD TR

Bed length	1900mm	Mattress material	PU
Bed with	650mm	Mattress height	80mm
Total length	2100mm	Mattress cover	Blue
Total width	800mm	Maximum user weight	250Kg
Trendelenburg and reverse	16°/-16°		

Tolerance: +/-1cm

NOTE: in case of divergence between text and image, prevails the information described in the text. For continuous improvement, Orthos XXI reserves the right to make changes to its products without prior notice. More information available in the product manual.

Update: 01/19

ORTHOS XXI, Unipessoal Lda.

Rua Santa Leocádia nº2735 // 4809-012 Sta. Leocádia de Briteiros // Guimarães // Portugal

Phone + 351 253 470 276 // Mobile +351 936 199 005 // Email margarida.silva@orthosxxi.com // Website www.orthosxxi.com

TROLLEY

MEDICINE TROLLEY	Pag 62
INSTRUMENT TROLLEY	Pag 63
CLEAN AND DIRTY CLOTHES TROLLEY	Pag 64
DIRTY CLOTHES TRANSPORT TROLLEY	Pag 65
DRESSING TROLLEY	Pag 67
MORTUARY TROLLEY	Pag 68

A three-tier stainless steel trolley with a blue laundry bag hanging from the top. The trolley has four casters and a handle on the left side. The blue bag is secured with blue straps.

MEDICINE TROLLEY



MEDICINE TROLLEY for patient transport with structure in soft steel tube. Litter holder car with four 100mm rotating wheels. Epoxy paint finish. Frame bed with hinged headboard

through gas damper. Rubber handle. Foam mattress. Pair of side grids and serum holder. Support for oxygen bottle included.

Technical data

MEDICINE TROLLEY			
Length	2000mm	Width	800mm
Height	600mm		

Tolerance: +/-1cm

NOTE: in case of divergence between text and image, prevails the information described in the text. For continuous improvement, Orthos XXI reserves the right to make changes to its products without prior notice. More information available in the product manual.

Update: 02/19

ORTHOS XXI, Unipessoal Lda.

Rua Santa Leocádia nº2735 // 4809-012 Sta. Leocádia de Briteiros // Guimarães // Portugal

Phone + 351 253 470 276 // Mobile +351 936 199 005 // Email margarida.silva@orthosxxi.com // Website www.orthosxxi.com

INSTRUMENT TROLLEY



INSTRUMENT TROLLEY stainless steel with top in frosted stainless steel plate. Protection grid on top. Equipped with 75mm castors.

Indicated for use in nursing homes, clinics or hospitals.

Technical data

Tolerance: +/-1cm

DRESSING TROLLEY

Dimensions

650x500x850mm

NOTE: in case of divergence between text and image, prevails the information described in the text. For continuous improvement, Orthos XXI reserves the right to make changes to its products without prior notice. More information available in the product manual.

Update: 05/2020

ORTHOS XXI, Unipessoal Lda.

Rua Santa Leocádia nº2735 // 4809-012 Sta. Leocádia de Briteiros // Guimarães // Portugal

Phone + 351 253 470 276 // Mobile +351 936 199 005 // Email margarida.silva@orthosxxi.com // Website www.orthosxxi.com

CLEAN AND DIRTY CLOTHES TROLLEY



CLEAN AND DIRTY CLOTHES TROLLEY, with polished stainless steel structure. With 3 removable stainless steel trays. It has a plastic

canvas bag. Equipped with 75mm castors. Suitable for use in homes, clinics or hospitals.

Technical data

CLEAN AND DIRTY CLOTHES TROLLEY

Reference: 55 CR I TP RP LS

Length	95cm
Width	45cm
Height	96cm

Tolerance: +/-1cm

NOTE: in case of divergence between text and image, prevails the information described in the text. For continuous improvement, Orthos XXI reserves the right to make changes to its products without prior notice. More information available in the product manual.

Update: 04/20

ORTHOS XXI, Unipessoal Lda.

Rua Santa Leocádia nº2735 // 4809-012 Sta. Leocádia de Briteiros // Guimarães // Portugal

Phone + 351 253 470 276 // Mobile +351 936 199 005 // Email margarida.silva@orthosxxi.com // Website www.orthosxxi.com

DIRTY CLOTHES TRANSPORT TROLLEY



Indicated for use at home, clinics or hospitals, *DIRTY CLOTHES TRANSPORT TROLLEY*, has structure in stainless steel frosted. Composed by plastic bag with metal lid. Equipped with

75mm castors. Also available in steel model with epoxy paint. There is also a dual-purpose transport vehicle, in epoxy-painted steel, with bags in plastic canvas

Technical data

DIRTY CLOTHES TRANSPORT TROLLEY SIMPLE INOX (55 CR I TP RP SJ SP)
DIRTY CLOTHES TRANSPORT TROLLEY SIMPLE STEEL (55 CR 3 TP RP SJ SP)
DIRTY CLOTHES TRANSPORT TROLLEY DOUBLE (55 CR 3 TP RP SJ DP)

Manufacturer: Orthos XXI

Dirty clothes transport trolley simple	560x560x850mm
Dirty clothes transport trolley double	1120x560x850mm

Tolerance: +/-1cm

NOTE: in case of divergence between text and image, prevails the information described in the text. For continuous improvement, Orthos XXI reserves the right to make changes to its products without prior notice. More information available in the product manual.

Update: 03/18

ORTHOS XXI, Unipessoal Lda.

Rua Santa Leocádia nº2735 // 4809-012 Sta. Leocádia de Briteiros // Guimarães // Portugal

Phone + 351 253 470 276 // Mobile +351 936 199 005 // Email margarida.silva@orthosxxi.com // Website www.orthosxxi.com

DRESSING TROLLEY



DRESSING TROLLEY, stainless steel plasters desk with 1 drawer + 1 bowl. With a shelf, drawer and top in frosted stainless steel plate. Protection grid on top. Bowl in stainless

steel, collapsible and removable. Equipped with 75mm castors. Indicated for use in nursing homes, clinics or hospitals.

Technical data

DRESSING TROLLEY

Reference: 55 ME I PE GV TI

Dimensions

600x400x700mm

Tolerance: +/-1cm

NOTE: in case of divergence between text and image, prevails the information described in the text. For continuous improvement, Orthos XXI reserves the right to make changes to its products without prior notice. More information available in the product manual.

Update: 03/18

ORTHOS XXI, Unipessoal Lda.

Rua Santa Leocádia nº2735 // 4809-012 Sta. Leocádia de Briteiros // Guimarães // Portugal

Phone + 351 253 470 276 // Mobile +351 936 199 005 // Email margarida.silva@orthosxxi.com // Website www.orthosxxi.com

MORTUARY TROLLEY



MORTUARY TROLLEY round. Structure in tube and plate in stainless steel, with cover in canvas.

Technical data

MORTUARY TROLLEY

Reference: Mortuary Trolley.Electric (55 MQ 3 EL EL)

Mortuary Trolley Hydraulic (55 MQ 3 EL HD)

Dimensions

200x60x80mm200x60x80mm

Tolerance: +/-1c

NOTE: in case of divergence between text and image, prevails the information described in the text. For continuous improvement, Orthos XXI reserves the right to make changes to its products without prior notice. More information available in the product manual.

Update: 03/18

ORTHOS XXI, Unipessoal Lda.

Rua Santa Leocádia nº2735 // 4809-012 Sta. Leocádia de Briteiros // Guimarães // Portugal

Phone + 351 253 470 276 // Mobile +351 936 199 005 // Email margarida.silva@orthosxxi.com // Website www.orthosxxi.com

FURNITURE



INSTRUMENT CABINET WITH LOCKER



INSTRUMENT CABINET WITH LOCKER, structure in soft steel sheet. Epoxy paint. With door and three glass shelves. Two models available:

model with 2 doors with 3 glass shelves or model with 1 door and 4 glass shelves.

Dados Técnicos

CABINET 1 DOOR 2 DOORS		
Reference: 55 AR 3 IT 1 P 55 AR 3 IT 2P CF		
	MODEL 1 DOOR	MODEL 2 DOORS
Comprimento	530mm	700mm
Largura	320mm	350mm
Altura	1450mm	1700mm

Toleracance: +/-1cm

NOTE: in case of divergence between text and image, prevails the information described in the text. For continuous improvement, Orthos XXI reserves the right to make changes to its products without prior notice. More information available in the product manual.

Update: 08/19

ORTHOS XXI, Unipessoal Lda.

Rua Santa Leocádia nº2735 // 4809-012 Sta. Leocádia de Briteiros // Guimarães // Portugal

Phone + 351 253 470 276 // Mobile +351 936 199 005 // Email margarida.silva@orthosxxi.com // Website www.orthosxxi.com

MEDICATION CABINET



MEDICATION CABINET, medication cabinet - Soft steel sheet structure. Epoxy paint. Upper locker consisting of two glass doors with metal hoops, locks and side panels in glass.

Three glass shelves. Lower locker consisting of 8-drawer block and with 2 lockable door plates.

Dimensions: 1750x1010x520mm

ORTHOS XXI, Unipessoal Lda.

Rua Santa Leocádia nº2735 // 4809-012 Sta. Leocádia de Briteiros // Guimarães // Portugal

Phone + 351 253 470 276 // Mobile +351 936 199 005 // Email margarida.silva@orthosxxi.com // Website www.orthosxxi.com

CABINETS



CABINETS, designed for storing medicines or instruments in doctors' cabinet. Wall-mounting cabinets with steel frame structure

with epoxy paint. Trunk by key. Available in 2 models: model with door and shelves in glass or model with door and shelves in steel plate.

Technical data

GLASS CABINETS | STEEL CABINETS

Reference: 55 AR 3 PA VI GE | 55 AR 3 PA AÇ ET

	GLASS MODEL	STEEL MODEL
Length	450mm	450mm
Width	250mm	250mm
Height	600mm	600mm

Tolerance: +/-1cm

NOTE: in case of divergence between text and image, prevails the information described in the text. For continuous improvement, Orthos XXI reserves the right to make changes to its products without prior notice. More information available in the product manual.

Update: 04/19

ORTHOS XXI, Unipessoal Lda.

Rua Santa Leocádia n°2735 // 4809-012 Sta. Leocádia de Briteiros // Guimarães // Portugal

Phone + 351 253 470 276 // Mobile +351 936 199 005 // Email margarida.silva@orthosxxi.com // Website www.orthosxxi.com

TREATMENT TABLE WITH 2 BOWLS



Polished stainless steel structure and shelves. Two stainless steel bowls, collapsible and removable. Protection grid on the top.

Equipped with 75mm castors. Indicated for use in homes, clinics or hospitals.

Technical data

TREATMENT TABLE WITH 2 BOWLS

Reference: 55 ME I AP 2T

Dimensions

60x40x70cm

Tolerance: +/-1cm

NOTE: in case of divergence between text and image, prevails the information described in the text. For continuous improvement, Orthos XXI reserves the right to make changes to its products without prior notice. More information available in the product manual.

Update: 04/20

ORTHOS XXI, Unipessoal Lda.

Rua Santa Leocádia nº2735 // 4809-012 Sta. Leocádia de Briteiros // Guimarães // Portugal

Phone + 351 253 470 276 // Mobile +351 936 199 005 // Email margarida.silva@orthosxxi.com // Website www.orthosxxi.com

TREATMENT TABLE



Polished stainless steel tube structure, with two stainless steel sheet trays. Equipped with

75mm castors. Indicated for use in homes, clinics or hospitals.

Technical data

TREATMENT TABLE

Reference: 55 ME I AP SP

Dimensions

60x45x86cm

Tolerance: +/-1cm

NOTE: in case of divergence between text and image, prevails the information described in the text. For continuous improvement, Orthos XXI reserves the right to make changes to its products without prior notice. More information available in the product manual.

Update: 04/20

ORTHOS XXI, Unipessoal Lda.

Rua Santa Leocádia nº2735 // 4809-012 Sta. Leocádia de Briteiros // Guimarães // Portugal

Phone + 351 253 470 276 // Mobile +351 936 199 005 // Email margarida.silva@orthosxxi.com // Website www.orthosxxi.com

MEDICAL SCREEN



TRIPLE MEDICAL SCREEN W / WHEELS - Structure in steel tube, epoxy paint, 1240x900 panels in hospital screen, equipped with wheels.



DOUBLE MEDICAL SCREEN W / WHEELS - Structure in steel tube, epoxy paint, 1240x900 panels in hospital screen, equipped with wheels.

Technical data

MEDICAL SCREEN			
Manufacturer: Orthos XXI			
TRIPLE MEDICAL SCREEN W / WHEELS		DOUBLE MEDICAL SCREEN WITH WHEELS	
Closed dimensions	157x71cm	Closed dimensions	157x71cm
Open dimensions	157x200cm	Open dimensions	157x136cm

Tolerance: +/-1cm

NOTE: in case of divergence between text and image, prevails the information described in the text. For continuous improvement, Orthos XXI reserves the right to make changes to its products without prior notice. More information available in the product manual.

Update: 04/20

ORTHOS XXI, Unipessoal Lda.

Rua Santa Leocádia nº2735 // 4809-012 Sta. Leocádia de Briteiros // Guimarães // Portugal

Phone + 351 253 470 276 // Mobile +351 936 199 005 // Email margarida.silva@orthosxxi.com // Website www.orthosxxi.com

ROTATING SEAT



ROTATING SEAT- Gas lift with back. Black polyamide base with five casters. Footrest in black polyamide.

Foam-lined seat and nappa.
Weight - 6.5kg.

ORTHOS XXI, Unipessoal Lda.

Rua Santa Leocádia nº2735 // 4809-012 Sta. Leocádia de Briteiros // Guimarães // Portugal

Phone + 351 253 470 276 // Mobile +351 936 199 005 // Email margarida.silva@orthosxxi.com // Website www.orthosxxi.com

AMAGNETIC

CELTA AMAGNETIC

Pag 78

AMAGNETIC COUCH

Pag 79



CELTA AMAGNETIC



CELTA AMAGNETIC, wheelchair with robust structure, made up of non-magnetic materials such as aluminum and stainless steel. Rear wheels massive 600mm and massive 200x30 front. Nylon wheels. Folding

armrests supports folding (or detachable) and detachable footrests. Designed in amagnetic material, in order to allow its use in a hospital environment, specifically with MRI machines.

Technical data

CELTA AMAGNETIC

Manufacturer: Orthos XXI | Reference: 51 CD CE I NO 46 NM

Seat width	40, 43, 46cm	Overall width	62, 65, 68cm
Seat depth	42cm	Total Depth	101cm
Seat height	51cm	Total Height	92cm
Seat height	43,5cm	Max user weight	150Kg

Tolerance: +/-1cm

NOTE: in case of divergence between text and image, prevails the information described in the text. For continuous improvement, Orthos XXI reserves the right to make changes to its products without prior notice. More information available in the product manual.

Update: 12/19

ORTHOS XXI, Unipessoal Lda.

Rua Santa Leocádia nº2735 // 4809-012 Sta. Leocádia de Briteiros // Guimarães // Portugal

Phone + 351 253 470 276 // Mobile +351 936 199 005 // Email margarida.silva@orthosxxi.com // Website www.orthosxxi.com

AMAGNETIC COUCH



AMAGNETIC COUCH, designed in amagnetic material, in order to allow its use in a hospital environment, specifically with MRI equipment. Bipartite structure, with articulated headboard. Height adjustable from 400 to 800mm, it facilitates the user's

ascent to the couch, as well as the caregiver's ergonomics. Padded bed coated with high resistance medical upholstery (several colours available). With paper roll holder.

Technical data

AMAGNETIC COUCH

Manufacturer: Orthos XXI | Reference: 55 MQ | EL HD

Length	185cm	Maximum height	80cm
Width	58cm	Maximum user height	100Kg
Minimum height	40cm		

Tolerance: +/-1cm

NOTE: in case of divergence between text and image, prevails the information described in the text. For continuous improvement, Orthos XXI reserves the right to make changes to its products without prior notice. More information available in the product manual.

Update: 12/19

ORTHOS XXI, Unipessoal Lda.

Rua Santa Leocádia nº2735 // 4809-012 Sta. Leocádia de Briteiros // Guimarães // Portugal

Phone + 351 253 470 276 // Mobile +351 936 199 005 // Email margarida.silva@orthosxxi.com // Website www.orthosxxi.com

PARALLEL BARS

Pag 81

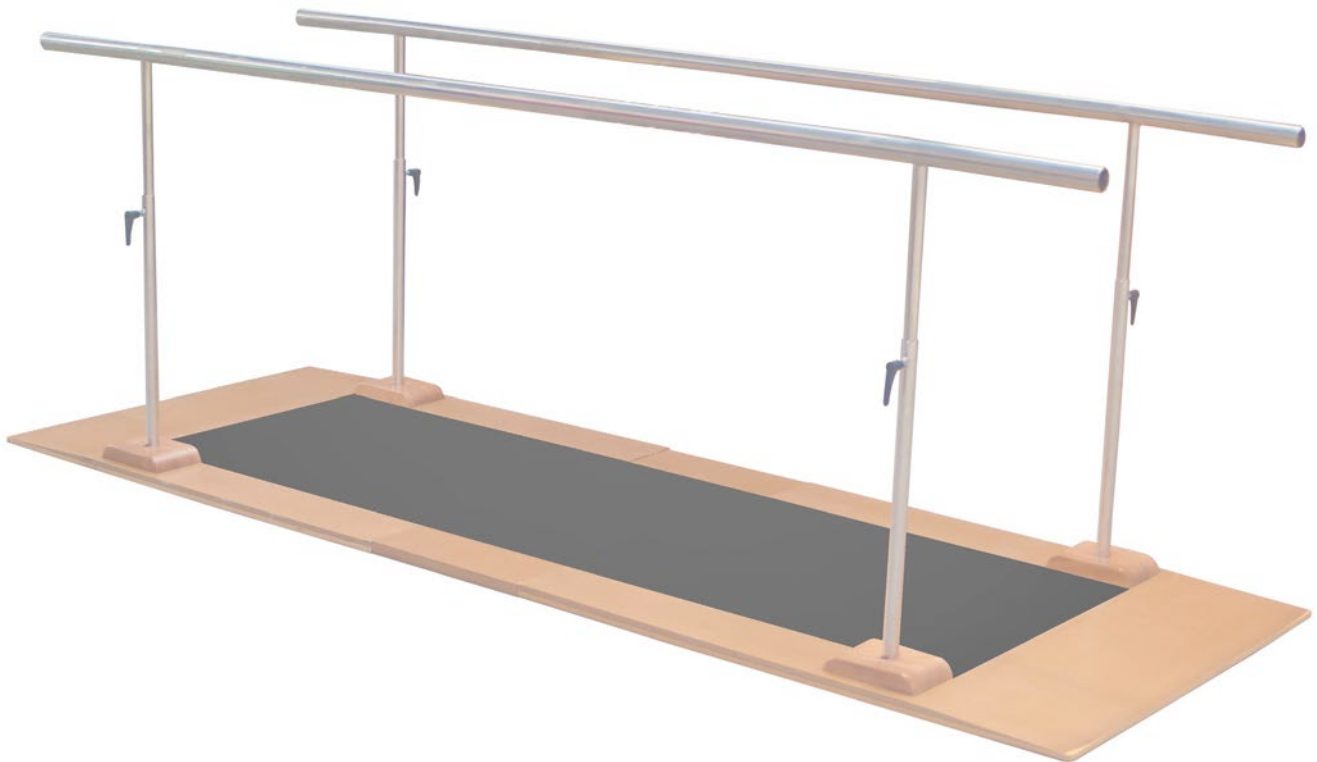

PARALLEL BARS



Parallel bars indicated for hospital or clinic use. Painted steel bottom frame and height adjustable stainless steel surface. Available in

various sizes: 2m, 3.5m or 4m. Option: wood base and non-slip material.

Technical data

PARALLEL BARS 2M | 3,5M | 4M

Manufacturer: Orthos XXI | Reference: 59 BR 3 PA 20 | 35 | 40

Model	2M	3,5M	4M
Lenght	2000mm	3500mm	4000mm
Wooden platform	Option	Option	Option

Tolerance: +/-1cm

NOTE: in case of divergence between text and image, prevails the information described in the text. For continuous improvement, Orthos XXI reserves the right to make changes to its products without prior notice. More information available in the product manual.

Update: 10/19

ORTHOS XXI, Unipessoal Lda.

Rua Santa Leocádia nº2735 // 4809-012 Sta. Leocádia de Briteiros // Guimarães // Portugal

Phone + 351 253 470 276 // Mobile +351 936 199 005 // Email margarida.silva@orthosxxi.com // Website www.orthosxxi.com

ORT HOS

inclusive solutions
HOSPITAL

ORTHOS XXI

Rua de Santa Leocádia I 4809-012 Santa Leocádia de Briteiros
Guimarães I Portugal
Mobile +351 936 199 005
Phone: (+351) 253 470 637/270
E-mail: margarida.silva@orthosxxi.com
Fax: (+351) 253 470 278
info@orthosxxi.com

www.orthosxxi.com

by

ORTHOS
xxi
e u r o p e a n
i n c l u s i v e s o l u t i o n s

QUALITY

RISK

PROTECTION

PREVENCIÓN
PREVENTION

**ORT
HOS**
inclusive solutions
PREVENTION

HISTORIA HISTORY

ORTHOS XXI es un fabricante europeo, ubicado en Portugal, perteneciente al universo del material ortopédico y hospitalario. Creada en 2007, ORTHOS XXI sucede a ORTOMAIA, cuya actividad empezó en el año 1985. A lo largo de su trayecto de más de 30 años, ORTHOS XXI ha crecido y se ha consolidado, haciéndose una empresa reconocida y respetada, convirtiéndose incluso en un punto de referencia para muchos. De cara al futuro, hemos inaugurado recientemente un nuevo pabellón, duplicando así las instalaciones productivas.

ORTHOS XXI añade a su condición de fabricante europeo con un amplio catálogo propio, la distribución de los productos de reputadas empresas nacionales e internacionales. Pretendemos así consolidar nuestra posición de one stop shop de cercanía, explotando en simultaneo la vertiente de las necesidades especiales.

ORTHOS XXI participa regularmente en actividades internacionales de promoción y comercio, en Ferias y Congresos en el sector de la Salud, así como en misiones empresariales en varios países de Europa y en los Continentes Americano y Africano.

ORTHOS XXI is an European manufacturer located in Portugal, belonging to the universe of orthoepedic and hospital materials. Founded in 2007, ORTHOS XXI succeeds ORTOMAIA, which activity began in 1985. Through these more than 30 years, ORTHOS XXI has grown and consolidated, converting itself into a recognised and respected company, a reference for many, even. Towards the future, we have recently inaugurated a new pavillion thereby doubling our production facilities.

ORTHOS XXI adds to its condition as an European manufacturer of an ever growing range of products, the distribution of products from reputed national and international companies, through agreements with them. We aim at consolidating our position as a vicinity one stop shop, simultaneously exploiting the special needs' aspect.

ORTHOS XXI regularly participates in international promotion and trade activities, in Exhibitions and Congresses in the Health sector, as well as in business missions, namely in a number of European countries, America and Africa.

VALORES VALUES

Nos mueve la convicción de que, con nuestra labor, contribuimos diariamente para la mejora de la calidad de vida y para la satisfacción de las necesidades de los usuarios de nuestros productos y servicios. Priorizamos una actitud de trabajo en equipo, flexibilidad y mejora continua. Consideramos fundamental una constante inversión en innovación y desarrollo de los productos, contando actualmente con un equipo dedicado exclusivamente a esta finalidad.

Estos valores soportan la presentación, en este nuevo catálogo, de algunas de las novedades desarrolladas más recientemente y, a la par, dar respuesta a las necesidades personalizadas de los usuarios.

We are moved by the belief that, through our work, with our products and services, we daily contribute towards the improvement of end users' life quality and the satisfaction of their needs. We value a team work, flexibility and continuous improvement attitude. We believe it is vital to have a continuous investment in innovation and development of our products, thereby currently having a dedicated team for that purpose.

These values enable us to present, in this catalogue, some of the latest developments and, in parallel, to provide customised solutions to the end users' needs.

CALIDAD QUALITY

La calidad de los productos de ORTHOS XXI puede ser confirmada en los mejores hospitales e instituciones, donde nos han elegido. La mayoría de nuestros productos son dispositivos médicos de clase 1 y ostentan el marcado CE, según las Directivas Comunitarias 93/42/CEE y 2007/47/CE y están registrados en la Autoridad competente, Infarmed. Son testados por entidades acreditadas e independientes, como el IBV (Instituto de Biomecánica de Valencia, en España). La empresa está también certificada según la norma EN ISO 9001:2008.

El valor y la cualificación de los recursos humanos a través de la implementación de actividades de entrenamiento y actualización en distintas áreas han sido fuertes apuestas de nuestra empresa. ORTHOS XXI tiene como principal preocupación la mejora continua de los procesos productivos y de los servicios, así como la mejora de la calidad de sus productos, lo que nos permite satisfacer cada vez mejor las necesidades y exigencias de clientes y usuarios.

The quality of ORTHOS XXI's products can be confirmed in the best hospitals and institutions, where they have been preferred. Most of them are Class 1 Medical Devices, CE marked in accordance with European Directives 93/42/CEE and 2007/47/CE and registred in the competent Authority, to Infarmed. Many are tested by well renowned and independent entities, namely IBV (Instituto de Biomecanica de Valencia, in Spain). The company is also certified in accordance to the EN ISO 9001:2008 Standards.

The qualification of ORTHOS XXI's human resources, through the implementation of training in various areas, has been a strong stake. ORTHOS XXI's main concerns are to continuously improve its productive processes and services as well as the quality of its products, so as to better satisfy our costumers and end user's needs and demands.

COJINES Y PROTECCIÓN ANTI-ESCARAS ***CUSHIONS AND BED SORES PROTECTION***

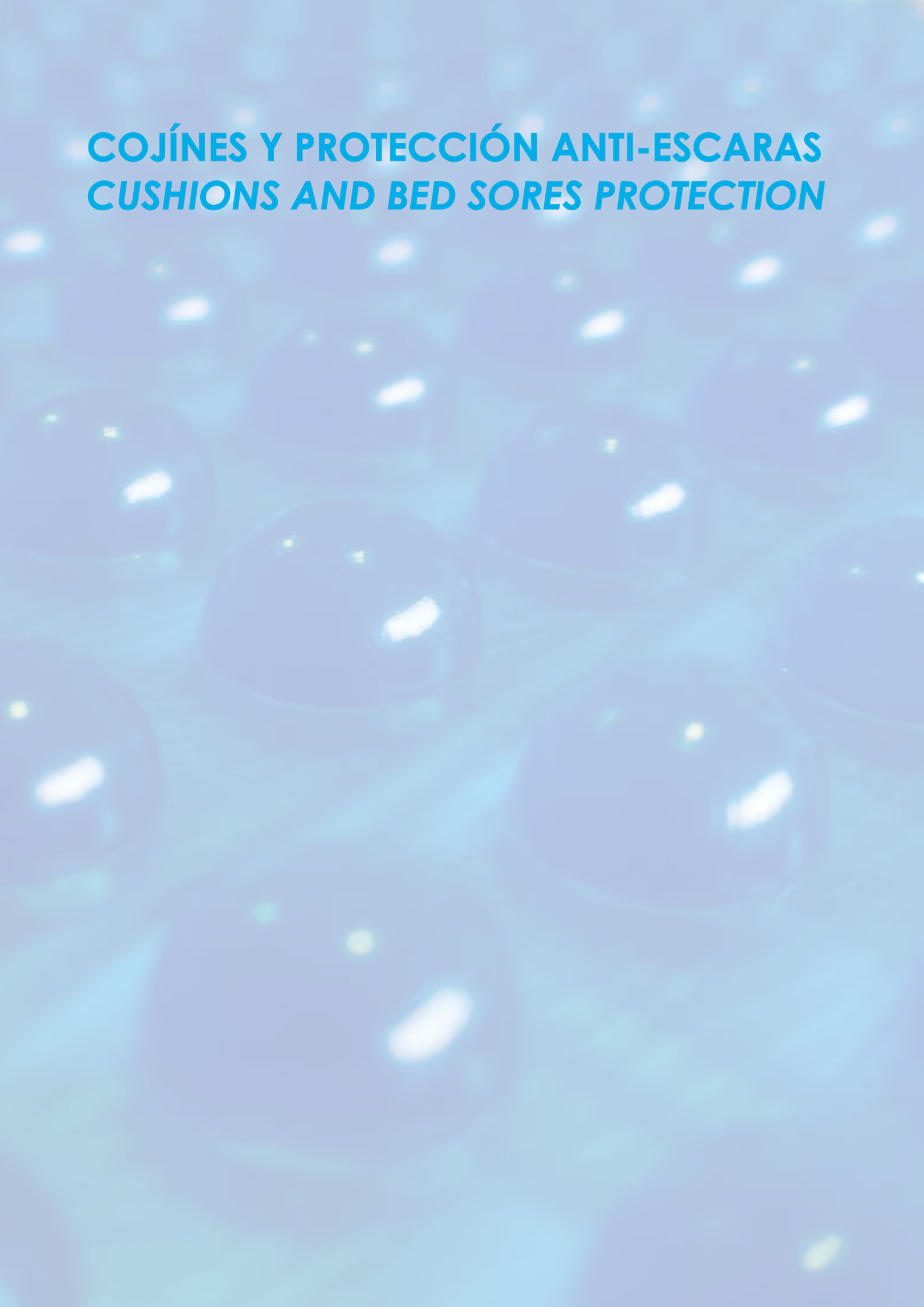

SOFTSEAT MEMORY FOAM ANATÓMICO ANATOMICAL MEMORY FOAM

SOFTSEAT, de ORTHOS XXI, en viscoelástico anatómico permite al paciente pasar largos períodos sentado, con reducido riesgo de contraer escaras, ayudando a su comodidad. Puede utilizarse como cojín de silla de ruedas, pero también para sillas ordinarias; para usuarios con dificultades de posicionamiento o poca flexibilidad en las articulaciones. Ligeras y fáciles de transportar, disponibles en varios espesores y materiales. Funda con 3 acabados a su elección: polisoft (negro), resistente y con aspecto de piel, para comfort; bielástica azul, impermeable a líquidos, permeable al aire, lavable y desinfectable; bielástica con tope en tela abeja, para evitar los efectos indeseables de la transpiración.

ORTHOS XXI'S SOFTSEAT in anatomic Memory Foam, allows the user to sit for long periods, with reduced risk of getting bed sores, aiding his comfort. To be used on wheelchairs, but also on ordinary chairs; for impaired users or users with low joints flexibility. Light and easy to carry, available in various thicknesses and materials. Cover with 3 finishings available: polisoft (black), resistant, skin look a like for comfort; bi-elastic blue, watertight and breathable, washable and disinfectable; bi-elastic with 3D cover, with an additional layer of 3D fabric to avoid the undesirable effects of transpiration.

PREVENTIVOS DE ESCARAS BED SORES PREVENTION



SOFTSEAT comfort
funda negra - polisoft
black cover - polisoft
63 AS CF PO 42x42x7cm



SOFTSEAT anti-escara bed sore
Funda azul - bielástica
Blue cover - bi-elastic
63 AS AE BI 07 PU 42x42x7cm



SOFTSEAT anti-escara bed sore
Funda azul - bielástica en tela abeja
Blue cover - bi-elastic w/ 3D
63 AS AE BI 07 42x42x7cm
63 AS AE BI 10 52x42x10cm

IDEAL PARA ESCARAS LOCALIZADAS IDEAL FOR LOCALIZED BED SORES



SOFTSEAT anti-escara bed sore
Coccix- funda bielástica en tela abeja
Coccix- bi-elastic cover in 3D
63 AS AE CX 42x42x10cm



SOFTSEAT anti-escara bed sore
Herradura- funda bielástica en tela abeja
Horseshoe- bi-elastic cover in 3D
63 AS AE FR 42x42x10cm



SOFTSEAT anti-escara bed sore
Agujero central- capa bielástica en tela abeja
Center hole- bi-elastic cover in 3D
63 AS AE BR 42x42x10cm

KITS PARA SILLAS KITS FOR CHAIRS



Soporte lumbar anatómico en tela abeja azul
Anatomical lumbar support in blue 3D cover
63 AP LB 3D

Soporte lumbar anatómico en polisoft
Anatomical lumbar support in polisoft
63 AP LB PO



Kit anti-escara para sillas de ruedas con funda bielástica
Bed sores kit for wheelchairs with bi-elastic cover

63 KT AE BI

También disponible funda con tela abeja
Also available in 3D fabric

BLUE GEL

Una de las complicaciones más comunes de pacientes acamados o con poca movilidad son las úlceras por presión o escaras, debido a presión prolongada sobre ciertas áreas de la piel. Ocurren normalmente en caderas, tobillos, muslos y espalda y, si no evitadas o tratadas inmediatamente, crean el riesgo de contraer infecciones y otras afecciones graves. Para evitar estos riesgos, los cojines y posicionadores BLUE GEL de ORTHOS XXI ayudan a distribuir la presión sobre la piel, reduciendo ese riesgo, pues se mueven con los usuarios, no contra ellos. En gel de polímero, no gotean, no contienen látex, plastificantes, o siliconas, causas frecuentes de reacciones alérgicas. Lavable y desinfectable. Adecuado para el entorno hospitalario. Cojines con fundas lavables y desinfectables, parte superior en terciopelo, agradable al tacto, y base en tela anti-deslizante.

One of the most common complications of bedridden or reduced mobility patients are pressure ulcers or bed sores, due to prolonged pressure on certain areas of the skin. Typically they occur on ankles, hips, buttocks and on the back and, if not prevented or treated immediately, the bed sores create the risk of contracting infections and other serious conditions. To avoid these risks, ORTHOS XXI BLUEGEL cushions and positioners help distribute pressure over the skin, reducing the risk of getting bed sores, because they move with users, not against them. Made of polymer gel, they don't drip, don't contain Latex, plasticisers, nor silicones, frequent causes of allergic reactions. Washable and disinfectable. Suitable for hospital environment. The cushions have washable and disinfectable covers, with a velvety fabric in the top and a non slippery fabric on the base.



BLUE GEL cojín cushion
63 AS 4BO 1840 40x41x1,8cm
63 AS 4BO 1843 43x41x1,8cm
63 AS 4BO 1846 46x41x1,8cm



BLUE GEL cojín cushion
63 AS 4BO 2846 46x41x2,8cm
63 AS 4BO 2860 50x41x2,8cm



BLUE GEL cojín herradura horseshoe cushion
63 AS 4FR 1540 40x41x1,5cm
63 AS 4FR 1543 43x41x1,5cm
63 AS 4FR 1546 46x41x1,5cm
63 AS 4FR 1550 50x43x1,5cm



BLUE GEL posicionador completo de cuerpo
 Complete body positioner
63 AP AE GE CC
 Cabeza head 50x23x1,5cm
 Tronco chest 100x50x1,5cm
 Extremidades inf. lower limbs 50x50x1,6cm



BLUE GEL - rostro
Face
63 AC AE GE FC2
25x20x10cm



BLUE GEL - occipital *occipital*
63 AC AE GE OT 2
20x7x5cm
pediátrico *paediatric*
63 AC AE GE OT 3
14x5x3cm
63 AC AE GE OT 7
14x7x2,5cm



BLUE GEL occipital herradura
Horseshoe occipital
63 AC AE GE OT F2
20x7x5cm
pediátrico *paediatric*
63 AC AE GE OT F4
10x4x2,5cm



BLUE GEL - cabeza universal
Head universal
63 AC AE GE UN 1
25x23x6cm
63 AC AE GE UN 2
25x18x3cm



BLUE GEL - cabeza oftalmológico
Head oftalmologic
63 AC AE GE OF 1
23x23x4cm
63 AC AE GE OF 3
24x22x7cm



BLUE GEL - cabeza cervical
Head cervical
63 AC AE GE CV
18x18x8cm



BLUE GEL - tronco *trunk*
63 AT AE GE
50x20x7cm



BLUE GEL - cunha *wedge*
63 AC AE GE 2
25x15x6cm



BLUE GEL - semi-cilíndrica
Semi-cylindrical
63 AI AE GE 1
30x15x7cm
63 AI AE GE 2
30x10x4cm
63 AI AE GE 8
50x15x7cm



BLUE GEL - brazo/pierna
Arm/leg
63 AP AE GE PB 2
40x15x4cm



BLUE GEL - talón
Heel
63 AP AE GE CL 1
18x10x7cm

RAMA DE SILICONA SILICONE FIBRE



Circular cerrado funda azul
Circular closed blue cover
63 AS AE BICI FE

Funda bielástica, impermeable a líquidos y transpirable. Espuma poliuretano 50kg/m³.

Bielastic, fire retardant, waterproof, breathable cover. Polyurethane foam 50kg/m³.

Diámetro externo Outer diameter: 37cm
Diámetro interior Inner diameter: 12cm
Espesor Thickness: 7cm



Circular cerrado piel sintética
Circular closed synthetic skin
63 AS AE PS CIFI E

Funda 50% algodón, 50% poliéster medicinal. Interior: 100% rama de poliéster.

50% cotton 50% polyester medicinal fur cover. Interior: 100% polyester fibre

Diámetro externo Outer diameter: 43cm
Diámetro interior Inner diameter: 10cm
Espesor Thickness: 10cm



Circular abierto piel sintética
Circular open synthetic skin
63 AS AE PS CI AB

Funda 50% algodón, 50% poliéster medicinal. Interior: 100% rama de poliéster.

50% cotton 50% polyester medicinal fur cover. Interior: 100% polyester fibre

Diámetro externo Outer diameter: 43cm
Diámetro interior Inner diameter: 10cm
Espesor Thickness: 10cm



Cuadrado piel sintética
Synthetic skin square
63 AS AE PS QD

Funda 50% algodón 50% piel poliéster medicinal. Interior: 100% rama de poliéster

50% cotton 50% polyester medicinal fur cover. Interior: 100% polyester fibre

Dimensiones Dimensions: 45x45x7cm

Cuadrado rama de silicona
Silicone fibre square
63 AS AE RS QD

Funda 50% algodón 50% poliuretano. Interior: 100% rama de poliéster.

50% cotton 50% polyurethane cover. Interior: 100% polyester fibre

Dimensiones Dimensions: 50x45x6cm



PIEL SINTÉTICA SYNTHETIC SKIN

Dispositivos de protección localizada para mayor confort y prevención y protección total.
Localized protection devices for comfort and total prevention and protection.



Piel sintética synthetic skin
63 PS AE 050/075/100/140

100% poliéster medicinal, anti-alérgico, no inflamable y de larga duración. Previene la formación de escaras y elimina las irritaciones de piel. Puede colocarse en contacto con la piel, aún muy sensible.

100% polyester medicinal fur, allergenic, non flammable and long lasting. Prevents the formation of bed sores and eliminates skin irritation. Can be put in contact with the skin even sensitive.

Dimensiones Dimensions: 70x50cm
70x75cm
70x100cm
70x140cm



Talonera heel
63 CC AE SI

Exterior: 100% algodón. Interior: 100% rama de poliéster silicónica. Previene la formación de escaras y elimina las irritaciones de piel. Puede colocarse en contacto con la piel, aún muy sensible.

Exterior: 100% cotton. Interior: silicone polyester fibre. Prevents the formation of bed sores and eliminates skin irritations. Can be put in contact with the skin, even if very sensitive.

Dimensiones Dimensions: 26x18x12cm



Codera elbow
63 PT AE CT

Algodón y piel poliéster medicinal. Previene la formación de escaras y elimina las irritaciones de piel. Puede colocarse en contacto con la piel, aún muy sensible.

Cotton and polyester medicinal fur. Prevents the formation of bed sores and eliminates skin irritations. Can be put in contact with the skin, even if very sensitive.

Dimensiones Dimensions: 15x19cm
(cada each)

COLCHONES MATRESSES

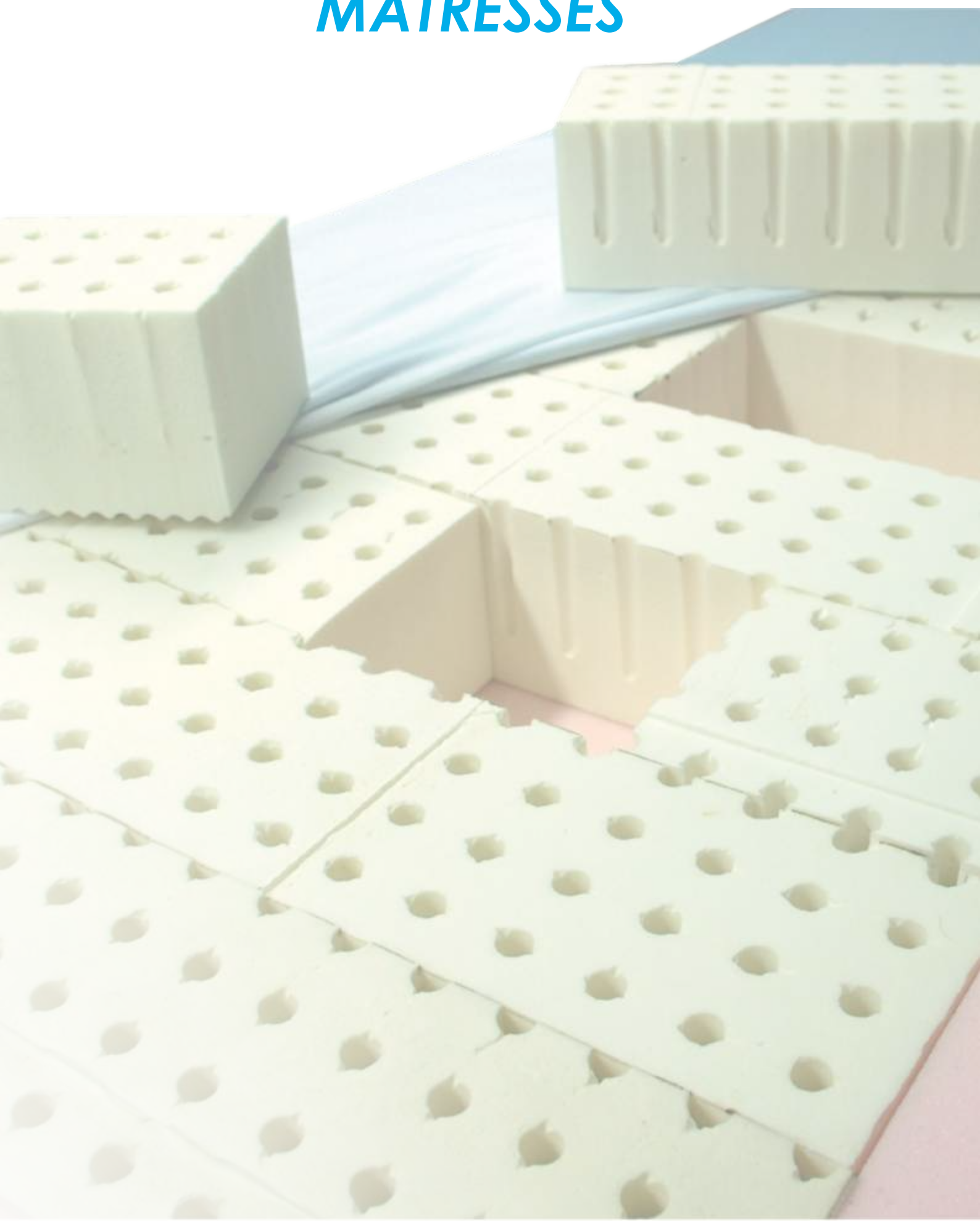

ANTI ESCARAS ESTÁTICOS

BED SORES STATIC

NINFA

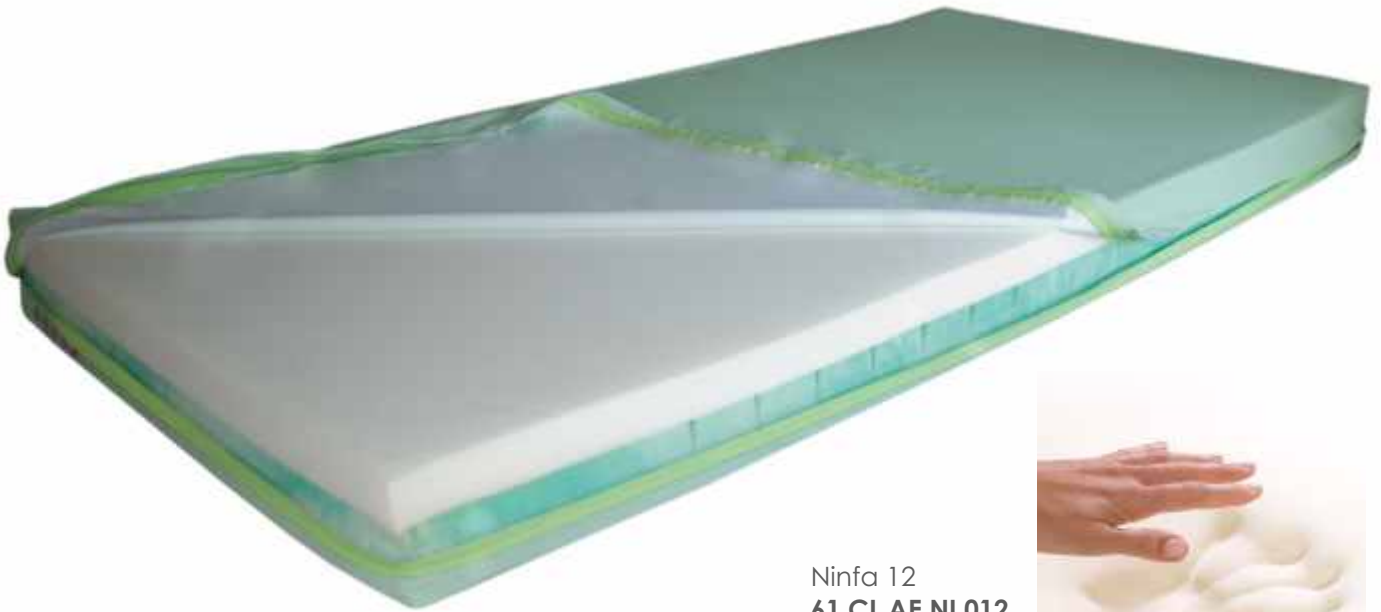

Ninfa 12
61 CL AE NI 012
Ninfa 14
61 CL AE NI 014



Diseñado para la prevención y tratamiento de úlceras de decúbito. Permite minimizar la presión sobre la piel para evitar su formación y/o acelerar su cura. El colchón Ninfa asegura la correcta postura ergonómica del cuerpo durante el sueño.

Ninfa 12, con 7cm de espuma en la base y 5cm de espuma de memoria en la parte superior.

Ninfa 14, con 9cm de espuma en la base y 5cm de espuma de memoria en la parte superior.

Funda bielástica impermeable a los líquidos y gases, transpirable, permite la respiración del interior y fácil higienización.

Resistente al fuego de acuerdo con la norma BS7175, 1989, Crib 5.

Interior en VISCOELÁSTICO plegable, muy acogedor que permite una probada reducción de la presión sobre la piel y sobre los vasos sanguíneos, contribuyendo para una mejor circulación de la sangre. El viscoelástico se adapta completamente al formato del cuerpo proporcionando una sensación de ligereza, traduciendo en un sueño muy tranquilo.

Dimensiones:

Ninfa 12: 190x90x12cm

Ninfa 14: 190x90x14cm

Designed for the prevention and treatment of bed sores. Minimizes pressure on the skin in order to avoid formation of bed sores and accelerate the healing of existing ones. Ninfa mattress ensures an ergonomic posture of the body during sleep.

Ninfa 12, with 7cm of foam on the base plus 5cm Memory Foam on the surface layer.

Ninfa 14, with 9cm of foam on the base plus 5cm Memory Foam on the surface layer.

Bi-elastic, waterproof, breathable cover that allows inner breathing and easy hygiene of the mattress. Fire-resistant according to BS7175, 1989, Crib 5.

Interior in Memory Foam foldable, extremely cozy, allowing the reduction of pressure on the skin and blood vessels, thus contributing to better blood circulation. Memory foam adapts completely to the format of the body providing a sense of lightness that translates into an extremely restful sleep.

Dimensions:

Ninfa 12: 190x90x12cm

Ninfa 14: 190x90x14cm

Nota: Los códigos son para camas individuales. Disponibles también colchones para parejas y por medida (bajo consulta).
Note: The codes are for single beds. Also available double beds and customized mattresses (on request).

APOLO

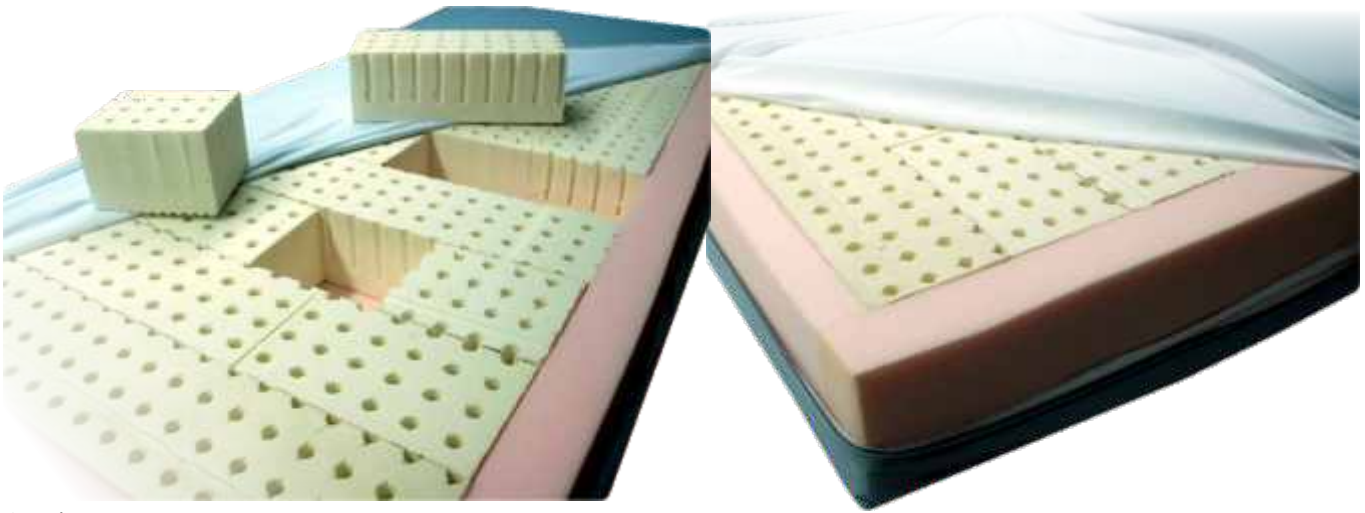

Apolo 61 CL AE AP

Diseñado para la prevención y tratamiento de úlceras de decúbito. Asegura la postura ergonómicamente correcta del cuerpo durante el sueño. Con cubos de látex con 12cm de espesor. Puede retirar uno o varios cubos en áreas donde desea reducir la presión. Base en espuma de elevada densidad con 5cm de espesor. Funda bielástica impermeable a líquidos y gases, transpirable, permite la respiración del interior y fácil higienización. Resistente al fuego de acuerdo con el norma BS7175, 1989, Crib 5.

Designed for the prevention and treatment of bed sores. Ensures the correct ergonomically posture of the body during sleep. With 12cm thick cubes of latex. You can take off one or more cubes in the areas where you want to reduce the pressure. The cube network is supported by a 5cm thick high density foam base. Bi-elastic watertight, breathable cover that allows inner breathing and easy hygiene. Fire-resistant according to BS7175, 1989 Crib 5.

Dimensiones Dimensions: 190x88x17cm



ATHENA



Athena 61 CL AE AT SI 61 CL AE AT SI BI

Sobrecolchón diseñado para minimizar la presión sobre la piel afin de contribuir a la prevención de úlceras de decúbito. Hecho con fibras huecas siliconadas no resinadas y revestimiento con tela 100% algodón. El sobrecolchón debe estar instalado sobre un colchón en buenas condiciones y con una superficie lisa. Permite ajustar su longitud. Funda bielástica impermeable a líquidos y transpirable, permite la respiración del interior y fácil higienización. Resistente al fuego de acuerdo con el norma BS7175, 1989, Crib 5.

Overmattress designed to minimize the pressure on the skin in order to contribute to the prevention of bed sores. Built with 100% hollow silicon fibres and coated with a 100% cotton fabric. The overmattress must be installed on a mattress in good conditions and with a smooth surface. Allows you to adjust its length. Bi-elastic cover impermeable to liquids and gases, breathable that allows the interior breathing and easy hygiene. Fire-resistant according to BS7175, 1989 Crib 5.

Dimensiones Dimensions: 210x90x15cm

HOSPITALARIOS HOSPITAL

HERA

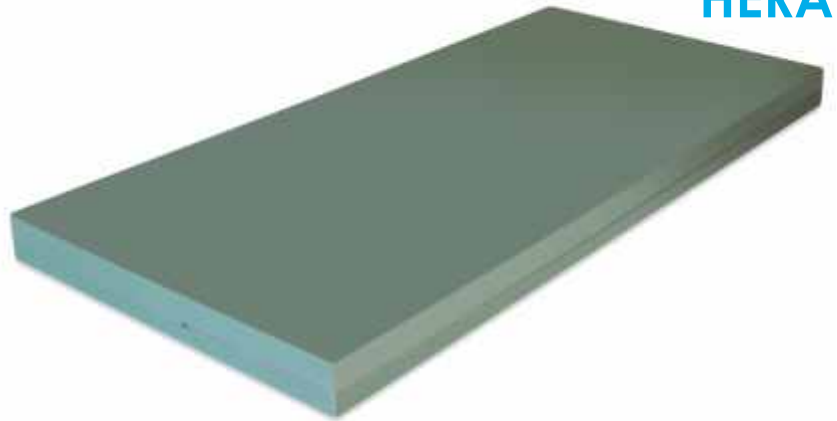
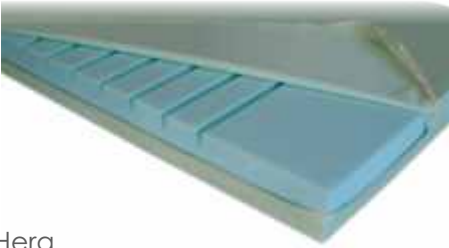

Hera

61 CL HP HE IT 010/012/014

Colchón en poliuretano con densidad de 28kg/m³ con rasgos interiores para la articulación y para la circulación del aire. Funda bielástica impermeable a líquidos y transpirable, permite la respiración del interior y fácil higienización. Resistente al fuego de acuerdo con el norma BS7175, 1989, Crib 5.

Polyurethane mattress with 28 kg/m³; with inner cuts to help articulation and air circulation. Bi-elastic waterproof, breathable cover that allows inner breathing and easy hygiene of the mattress. Fire-resistant according to BS7175, 1989, Crib 5.

Dimensiones *Dimensions*: 190x90x10/12/14cm

URANO

CUBOS CUBES

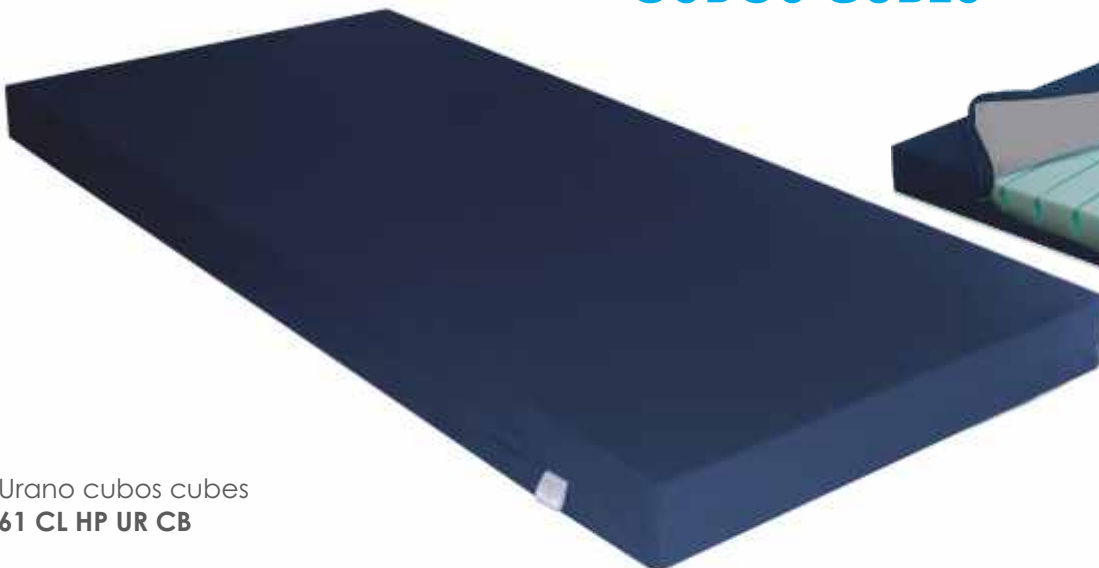

Urano cubos cubes

61 CL HP UR CB

Colchón en poliuretano de 28kg/m³. La configuración en cubos recortados o ondulados ayuda a la prevención de escaras por la disminución de la presión y circulación del aire, a través de sus canales y por simples movimientos del cuerpo, adaptándose anatómicamente. Funda bielástica impermeable a líquidos y gases, transpirable, permite la respiración del interior y fácil higienización. Resistente al fuego de acuerdo con el norma BS7175, 1989, Crib 5.

Polyurethane mattress with 28 kg/m³. The configuration of the cut cubes helps prevent bed sores by decreasing the pressure and allowing air circulation, through their channels. Anatomically adapted by simple body movements. Bi-elastic waterproof, breathable cover that allows inner breathing and easy hygiene of the mattress. Fire-resistant according to BS7175, 1989, Crib 5.

Dimensiones *Dimensions*: 190x90x14cm

COLCHONES CONFORT
COMFORT MATTRESSES



AFRODITE

61 CL HC AF N

EROS

61 CL HC ER N



Con 100% látex, material firme y elástico que permite un soporte correcto la columna vertebral y facilita la circulación sanguínea. Látex, producto natural muy poroso con gran ventilación. Hipoalergénico, impide el crecimiento de bacterias, hongos y ácaros en su interior. Colchones articulados y reversibles con 2 lados iguales. Funda bielástica impermeable a líquidos y permeable al aire, transpirable, permite la respiración del interior y fácil higienización. Resistente al fuego de acuerdo con la norma BS7175, 1989, Crib 5.

Afrodite: Núcleo con 12cm de látex, pudiendo elegir entre 3 densidades.

Eros: Núcleo con 15cm de látex, pudiendo elegir entre 3 densidades.

Puede elegir entre 3 densidades, dependiendo de las preferencias del usuario o peso del cuerpo:

Normal: Látex 60 kg/m³, para usuarios hasta 70kg o preferencia por colchones de baja consistencia.

Firme: Látex 70kg/m³, para usuarios hasta 85kg, o preferencia por colchones de mediana consistencia.

Extra firme: Látex 80kg/m³, para usuarios con más de 85kg o preferencia por colchones de alta consistencia.

100% Latex, firm and elastic material that allows a correct spinal support and facilitates blood circulation. Latex, very porous natural product with great ventilation. Hypoallergenic product which naturally prevents the growth of bacteria, fungi and dust mites. Reversible articulated mattresses with 2 equal sides.

Bi-elastic waterproof, breathable cover that allows the interior breathing and easy hygiene. Fire-resistant according to BS7175, 1989, Crib 5.

Afrodite: 12cm Latex core, with 3 densities depending on body weight or user preferences.

Eros: 15cm Latex core, with 3 densities depending on body weight or user preferences.

You can choose from 3 densities, depending on body weight or user preferences:

Normal: 60 kg/m³ latex, for users up to 70kg or preference for low consistency mattresses.

Firm: 70 kg/m³ latex, for users up to 85kg, or preferably for medium consistency mattresses.

Extra firm: 80 kg/m³ latex, for users exceeding 85kg or preference for high consistency mattresses.

Dimensiones Dimensions Afrodite: 190x90x12cm

Dimensiones Dimensions Eros: 190x90x15cm

Nota: Los códigos son para camas individuales. Disponibles también colchones para parejas y por medida (bajo consulta).
Note: The codes are for single beds. Also available double beds and customized mattresses (on request).



EXTRA-CONFORT EXTRA COMFORT

DUPLO LÁTEX



Duplolátex015
61 CL CF DL15 N
Duplolátex018
61 CL CF DL18 N



100% látex, material firme y elástico que permite un soporte correcto de la columna vertebral y facilita la circulación sanguínea. Látex, producto natural muy poroso con gran ventilación. Hipoalergénico, impide el crecimiento de bacterias, hongos y ácaros. Colchón DUPLO LÁTEX con una capa superficial de 2cm de Climalátex, un látex muy suave incluso más ventilado que el látex tradicional, facilitando la circulación sanguínea. Gran capacidad de ventilación, permitiendo evaporarse rápidamente la transpiración, permanece seco y sin humedad. Funda Duvalcare con 50% algodón, 25% poliéster, 25% poliamida, relleno con tratamiento Duvalcare. Con propiedades antibacteriales, anti-fúngicas y anti-ácaros. Tratamiento permanente en el hilo, no desaparece tras el lavado. Suave textura y flexible con buena ventilación y fácil de lavar. Tejido respirable, impidiendo la aparición de humedad y olores.

Puede elegir entre 3 densidades, dependiendo de las preferencias del usuario o peso del cuerpo:

Normal: Látex 60 kg/m³ y climalatex 65kg/ m³, para usuarios hasta 70kg o preferencia por colchones de baja consistencia.

Firme: Látex 70kg/m³ y climalatex 65kg/ m³, para usuarios hasta 85kg, o preferencia por colchones de mediana consistencia.

Extra firme: Látex 80kg/m³ y climalatex 65kg/ m³, para usuarios con más de 85kg o preferencia por colchones de alta consistencia.

100% latex mattress, firm and elastic material that allows a correct spinal support and facilitates blood circulation. Latex, very porous natural product, with great ventilation, hypoallergenic which naturally prevents the growth of bacteria, fungi and dust mites. DUPLO LATEX mattress has a layer of 2cm Climalátex, a very soft latex, more ventilated than traditional Latex, facilitating blood circulation. With a great ventilation capacity, allowing quick evaporation of transpiration, staying dry and moisture free. Duvalcare fabric cover with 50% cotton, 25% polyester, 25% polyamide, filling with Duvalcare treatment. The fabric has antibacterial, anti-fungic and anti mites properties. These characteristics are not changed after washing because the treatment on the wire is permanent. Smooth and flexible texture with natural capacity of ventilation and easy to wash. Breathable fabric, preventing the appearance of moisture and odors.

You can choose between 3 densities, depending on body weight or user preferences:

Normal: 60kg/m³ latex and 65kg/m³ climalatex, for users up to 70kg or preference for low consistency mattresses.

Firm: 70 kg/m³ latex and 65kg/m³ climalatex, for users up to 85kg, or preferably for medium consistency mattresses.

Extra: firm: 80 kg/m³ latex and 65kg/m³ climalatex, for users exceeding 85kg or preference for high consistency mattresses

Dimensiones Dimensions: 190x90x15/18cm

SUAVE LIGHT

Suavelight015
61 CL CD SU15 S
 Suavelight018
61 CL CD SU18 S

SUAVE VENUS

Suavevenus
61 CL CD VE N



Suave light: Con una capa de 2cm en viscoelastico y un núcleo de 12cm o 15cm en látex.

Suave venus: Con una capa de 5cm en viscoelastico y un núcleo de 12cm en látex.

Con capa en espuma viscoelástica, extremadamente acogedora, permite una comprobada reducción de la presión ejercida sobre la piel y vasos sanguíneos, contribuyendo así para la mejor circulación sanguínea. La viscoelasticidad se adapta completamente al formato del cuerpo proporcionando una sensación de ligereza que resultan en un sueño muy tranquilo. Núcleo de 12cm o 15cm en látex, material de origen natural, poroso, que permite una excelente ventilación, hipoalergénico que impide naturalmente el crecimiento de bacterias, hongos y ácaros. Es un material elástico y flexible que permite un correcto soporte de la columna vertebral y facilita la circulación sanguínea. Funda en Duvalcare con 50% Algodón, 25% Poliéster, 25% Poliamida, con tratamiento Duvalcare. Con propiedades antibacterianas, anti-fúngicas y anti-ácaros. Tratamiento permanente en el hilo, no desaparece tras el lavado. Suave textura y flexible con buena ventilación y fácil de lavar. Tejido respirable, impidiendo la aparición de humedad y olores.

Puede elegir entre 3 densidades, dependiendo de las preferencias del usuario o peso del cuerpo:

Normal: Látex 60kg/m³ y viscoelastico 53kg/m³, para los usuarios hasta 70kg o preferencia por colchones de baja consistencia.

Firme: Látex 70kg/m³ y viscoelastico 53kg/m³, para usuarios hasta 85kg, o preferencia por colchones de mediana consistencia.

Extra firme: Látex 80kg/m³ y viscoelastico 53kg/m³, para usuarios con más de 85kg o preferencia por colchones de alta consistencia.

Suave light: with a superficial layer of 2cm Memory Foam and a nucleus of 12 or 15cm in Latex.

Suave venus: with a superficial layer of 5cm Memory Foam and a nucleus of 12 Latex.

The superficial layer in memory foam is a viscoelastic foam, extremely cosy, allowing the reduction of pressure on the skin and blood vessels, contributing for a better blood circulation. The viscoelasticity completely fits the format of body providing a sense of lightness that results in a very peaceful dream. Nucleus of 12 or 15cm Latex, natural material, porous, which allows excellent ventilation, hypoallergenic, blocks the natural growth of bacteria, fungi and mites in its interior. Elastic material that allows a proper lift of the column. Is elastic and flexible, that facilitates the blood circulation. Cover in Duvalcare fabric with a composition of 50% cotton, 25% Polyester, 25% polyamide filling, with Duvalcare treatment. The Duvalcare fabric has antibacterial, anti-fungal and anti-mite treatment. This features do not change after washing because the treatment in the thread is permanent. Soft and flexible texture with the natural capacity of transpiration and easy to wash. Breathable fabric, preventing the appearance of moisture and odors.

You can choose between 3 densities, depending on body weight or user preferences:

Normal: 60 kg/m³ latex and 53kg/ m³ memory foam, for users up to 70kg or preference for low consistency mattresses.

Firm: 70 kg/m³ latex and 53kg/ m³ memory foam, for users up to 85kg, or preference for medium consistency mattresses.

Extra firm: 80kg/m³ latex and 53kg/ m³ memory foam, for users exceeding 85kg or preference for high consistency mattresses.

Dimensiones Dimensions Suave light: 190x90x15/18cm

Dimensões Dimensions Suave venus: 190x90x17cm

Nota: Los códigos son para camas individuales. Disponibles también colchones para parejas y por medida (bajo consulta).
 Note: The codes are for single beds. Also available double beds and customized mattresses (on request).

ZEUS

61 CL PS ZE NG

61 CL PS ZE CS

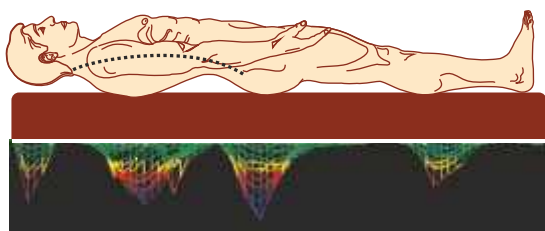

Colchón duro - excesiva rigidez:

- Exceso de presión provoca a oclusión dos capilares (hormigueros)
- La columna está en una posición incorrecta (falta de apoyo en la columna lumbar)

Hard mattress-excessive rigidity:

- The excess pressure leads to capillary occlusion (anthsills)
- The column is in an incorrect position (lack of support in the lumbar spine)

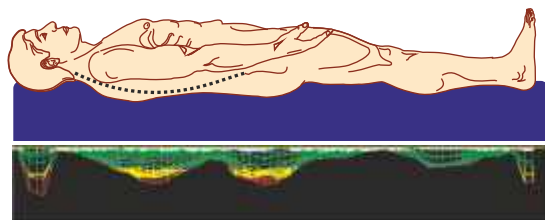

Colchón mole o degradado - sustentación deficiente:

- La columna permanece en posición incorrecta (aumento de la Cifose Dorsal) y atenuación o reversión del Lordose Lumbar.

Soft mattress or degraded-poor support:

- The column stays in position incorrect (increased Thoracic Kyphosis)and mitigation or reversal of Lumbar Lordosis.

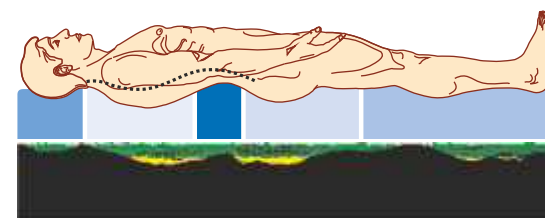

Sustentación optimizada:

- Baja presión en la piel, manteniendo en buena condición la circulación sanguínea en los capilares
- Columna vertebral en decúbito en el posición anatómicamente correcta, en todo similar a la postura erecta.

Optimal support:

- Low pressure on the skin, keeping in good condition the blood circulation in capillaries
- Spinal column in decubitus in the correct anatomical position, similar to erect posture.

personalizado custom...

...el colchón à su medida the custom made mattress

Acomoda las áreas corporales más propensas a presiones (omóplatas, hombros, columna lumbar y caderas), independientemente de que duerma acostado boca arriba, de lado o boca abajo. Elimina la presión elevada intra dérmica en los puntos de mayor relieve o concentración de peso, evitando el constante cambio de posición, hormigueo o letargo de brazos y piernas que molestan el reposo. Mantiene la columna vertebral en su posición correcta, evitando así padecimiento de esta. Puede personalizar el tamaño y la densidad de acuerdo al usuario. En resumen, un colchón que ofrece lo que tu cuerpo merece: una noche tan tranquila como tu espíritu. Analizados y fabricado por el médico de la Orthos XXI según las características físicas, bio-antopométricas y según el cuadro clínico, si hay alguna patología.

Accommodates the areas more inclined to pressures (shoulder blades, shoulders, lumbar spine and hips), regardless of whether you sleep lying on your back, side or face down. Eliminates intradermic high pressure zones in the points of higher protuberance or concentration of weight, therefore avoiding the constant change of position, or tingling of arms and legs sleep that disturb the sleep. Keeps the spinal column in its correct position, thereby preventing suffering. Customize the size and density according to the user. In summary, a mattress that offers what your body deserves: a night so quiet as your spirit. Analyzed and manufactured by the doctor of Orthos XXI according to the physical characteristics, bio-antopométrics and according to the clinical picture, if there is any pathology.

De los estudios y ensayos realizados, resultó en un Software, que desde el peso del cuerpo, porcentaje de grasa, de estatura y del localización de algunos puntos anatómicos - Acrómion, vértice de omóplata, Crísta Iliaca Antero-superior y Gran trocánter femoral - y el valor de los perímetros, abdominales, caderas y hombros, permite así personalizar su colchón.

Of the studies and trials conducted, resulted in a Software, which from the body weight, fat percentage, of stature, and location of some anatomical points - acrómion, vertex of the scapula, Antero-superior Iliac crest and Femoral Trochanter - and yet, the value of the perimeters, Abdominal, hips and shoulders, allows to customize your mattress.

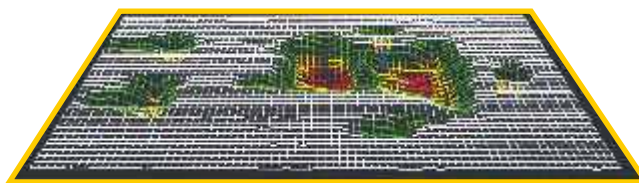

Una presión superior a 32 mmHg, sobre la piel provoca oclusión de los capilares. La circulación sanguínea se ve perjudicada con picor resultante y cambios de posición frecuentes que interrumpen el sueño. One pressure superior to 32 mmHg, exerted on the skin causes occlusion of capillaries. Blood circulation is affected with consequent itching and frequent position changes that disrupt the sleep.



Gráficos e escala ERGOCHECK

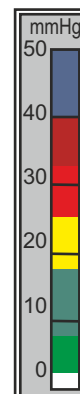



Zeus
61 CL PS ZE NG
61 CL PS ZE CS



Con una capa de 3cm en viscoelastico y 3cm en Climalátex con un núcleo de 15cm en Látex.

Espuma de memoria: Espuma viscoelástica, extremadamente acogedora, permite una comprobada reducción de la presión ejercida sobre la piel y vasos sanguíneos, contribuyendo para la mejor circulación sanguínea. La viscoelasticidad se adapta completamente al formato del cuerpo proporcionando una sensación de ligereza que resultan en un sueño muy tranquilo.

Climalatex: Látex muy suave incluso más ventilados de látex tradicional, facilitando la circulación del flujo de sangre. Tiene una gran capacidad para la ventilación, permitiendo evaporarse rápidamente la transpiración, permanece seco y sin humedad.

Látex: Material de origen natural. Como la mayoría de los productos de origen natural, el Latex es poroso, que permite una excelente ventilación. Hipoalergénico que impide el crecimiento natural de bacterias, hongos y ácaros. Es un material firme y elástico, que permite un apoyo adecuado a la columna vertebral. Es elástico y flexible, facilitando la circulación sanguínea. Tiene una gran longevidad. Colchón fabricado exclusivamente para su usuario, de conformidad con sus características físicas. Tiene una superficie de confort en Climalátex o en Viscoelastico. Está construida con 5 a 10 zonas con diferentes densidades y dimensiones, según el usuario. Colchón que permite una postura ergonómicamente correcta. Funda de lujo con 20% algodón, 15% poliéster, 65% poliamida y llenado hipoalergénico.

Made by one layer of 3cm in Memory Foam, 3cm in Climalátex and with a nucleus of 15cm in Látex.

Memory foam: Viscoelastic foam, extremely cosy, allowing the reduction of pressure on the skin and blood vessels, contributing for a better blood circulation. The viscoelasticity completely fits the format of body providing a sense of lightness that result in a very peaceful dream.

Climalatex: Is a very soft Latex even more ventilated than traditional Latex, facilitating blood circulation. Has a great ventilation capacity, allowing to quickly evaporate the transpiration, staying dry and moisture free.

Látex: Material of natural origin. Like most products of natural origin, the latex is porous, which allows excellent ventilation. Hypoallergenic product which naturally prevents the growth of bacteria, fungi and dust mites. It is a firm and elastic material which allows a correct spinal support. Has a great longevity. Mattress fully manufactured exclusively for its user, according to their physical characteristics. It has a surface of comfort on Climalátex or Memory Foam. It is built with 5 to 10 zones, with varying densities and dimensions, according to the user. Mattress that allows an ergonomical correct posture. Luxury fabric cover with 20% cotton, 15% polyester, 65% polyamide and hypoallergenic filling.

Dimensiones Dimensions: 190x90x21 cm

Nota: Los códigos son para camas individuales. Disponibles también colchones para parejas y por medida (bajo consulta).
Note: The codes are for single beds. Also available double beds and customized mattresses (on request).

ADONIS



Adonis
61 CL CD AD 22 C



Muelles embolsadas
Bagged springs



Colchón cuyo componente principal son muelles embolsadas, complementado por dos áreas de confort, una en espuma viscoelástica (invierno) con 2 cm de espesor y otra en Climalátex (verano) con 3 cm de espesor. El colchón de muelles embolsadas ADONIS tiene una comodidad muy superior a los colchones de muelles normales y proporcionan una noche de descanso perfecto. El colchón de muelles embolsadas ADONIS, tiene una estructura muy diferente de los colchones de muelles normales porque se compone de una carcasa donde los muelles están en envases independientes, o embolsados en un envase individual y es este tipo de envase individual que proporciona una mayor comodidad y estabilidad, porque el colchón de muelles embolsadas no hace el hundimiento en el centro. Esto provoca que cada elemento de la pareja permanezca inmóvil aunque el otro se moviera. Para aquellos que sufren de insomnio, esta puede ser la diferencia entre dormir una noche de sueño o no. Además de ser más estable y con menos hundimiento, tiene mucho más durabilidad que una carcasa de muelles normales. Funda en tejido Duvalcare con 50% algodón, 25% poliéster, 25% enchimento poliamida, con tratamiento Duvalcare. Con propiedades antibacterianas, anti-fúngicas y anti-ácaros. Tratamiento permanente en el hilo, no desaparece tras el lavado.

Mattress whose main component are the bagged springs, complemented by two areas of comfort, one in Memory Foam (winter) with 2 cm thick, and another in Climalátex (summer) with 3 cm thick. The bagged spring mattress ADONIS has a much higher comfort than the normal spring mattresses, and provide a perfect night's rest. The bagged spring mattress ADONIS, has a very different structure from normal spring mattress because it is composed of a carcass where the springs are in independent packages, or on an individual package, providing greater comfort and stability, because unlike normal Spring mattress, does not sink in the centre. This provides that each element of the couple remains quiet even though the other element is in motion. For those who suffer from insomnia, this can be the difference between a sleepless night or not. In addition to being a more stable and with less sinking, has much more durability than a normal spring mattress. Cover in Duvalcare fabric with 50% cotton, 25% polyester, 25% polyamide filling, with Duvalcare treatment. The Duvalcare fabric has antibacterial, anti-fungal and anti-mite treatment. This features do not change after washing because the treatment in the thread is permanent. Soft texture and flexible with the natural capacity of transpiration and easy to wash. Breathable fabric, preventing the appearance of moisture and odors.

Dimensiones hasta *Dimensions up to*: 200x150cm (bajo medida/customized)

Textura suave y flexible con buena ventilación y fácil de lavar. El tejido es respirable, impidiendo la aparición de humedad y olores.



ALMOHADAS DE DORMIR
SLEEPING PILLOWS

MEDUSA

MEMORY FOAM - máxima comodidad *maximum comfort*

MEDUSA de ORTHOS XXI permite la corrección de anatomía de la columna cervical, llevando a una relajación de los músculos del cuello. Hecho en viscoelástico, se adapta completamente al formato de su cuerpo y cabeza, proporcionando-lhe una increíble sensación de ligereza que resultan en un sueño muy tranquilo. Las sus características visco-elásticas reducen la presión sobre la piel manteniendo en buena condición la circulación sanguínea. El tejido utilizado para la cubierta protectora es un terciopelo con 50% poliéster, 50% Safesleep y con hilo de plata con propiedades antibacterianas, anti-fúngicas y anti-ácaros. La tela tiene una textura suave. Resistente al fuego de acuerdo con el norma BS7175, 1989, Crib 5.

The MEDUSA pillow of Orthos XXI allows the correction of the anatomy of the cervical spine, leading to a relaxation of the muscles of the neck. Made in Memory Foam, adapts completely to the format of your body and head, giving you an incredible sense of lightness that result in an extremely restful sleep. The Visco-elastic characteristics reduce the pressure on the skin keeping the blood circulation in good condition. The fabric used for the protective cover is a velvet with 50% polyester, 50% Safesleep and with silver thread that gives antibacterial, anti-fungal and anti-mite characteristics. The fabric has a smooth texture. Fire-resistant according to BS7175, 1989, Crib 5.



Medusa perforada *drilled*

62 AL DO ME TR PF

60 x 35 x 15cm

Medusa tradicional *traditional XL*

62 AL DO ME TR XL

60 x 40 x 15cm

Medusa tradicional *traditional XXL*

62 AL DO ME TR XXL

90 x 35 x 15cm

Cubierta en terciopelo
Velvet cover

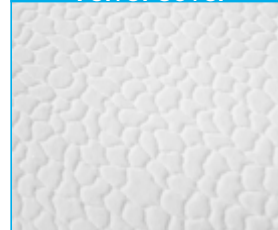

Viscoelastico
Memory foam



Medusa anatómica *anatomic M*

62 AL DO ME AN M

50 x 33 x 10/8cm

Medusa anatómica *anatomic L*

62 AL DO ME AL L

50 x 33 x 12/10cm

Medusa anatómica canelada *crenellated anatomical*

62 AL DO ME ANC M

50 x 35 x 11/9cm

Nota: Las almohadas MEDUSA están disponibles con una cubierta interior para facilitar la remoción de la cubierta exterior para lavado.
Note: The MEDUSA pillows are available with inner cover to facilitate the removal of the outer bag to wash.

Soporte ideal para la columna cervical Ideal support for the cervical spine

Quimera de ORTHOS XXI permite la corrección de anatomía de la columna cervical, llevando a una relajación de los músculos del cuello. 100% Climalátex perforado que mejora la circulación de aire previniendo la acumulación de humedad. El Climalátex es un material blando que no hace sonidos cuando se presiona, posibilitando así dormir cómodamente sin ruido. El tejido utilizado para la cubierta protectora es un terciopelo con 50% poliéster, 50% Safesleep y con hilo de plata con propiedades antibacterianas, anti-fúngicas y anti-ácaros. La tela tiene una textura suave y es resistente al fuego de acuerdo con el norma BS7175, 1989, Crib 5.

The QUIMERA pillows of Orthos XXI allows the correction of the Anatomy of the cervical spine, leading to a relaxation of the muscles of the neck. Made of 100% drilled Climalátex that improves air circulation preventing the accumulation of moisture. The Climalátex is a soft material that does not do sounds when pressed, allowing to sleep comfortably without noise. The fabric used for the protective cover is a velvet with 50% Polyester, 50% Safesleep and with silver thread that gives antibacterial, anti-fungal and anti-mite characteristics. The fabric has a smooth texture and is fire-resistant according to BS7175, 1989, Crib 5.

Quimera cervical M

55 x 38 x 8/10cm

Quimera cervical L/XL

60 x 38 x 10/12cm

cubierta en terciopelo
velvet cover

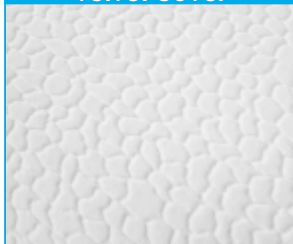

climalátex perforado
drilled Climalátex



Quimera tradicional *traditional*

55 x 38 x 12cm

Baby M

39 x 23 x 5cm

Baby XL

60 x 24 x 5cm

Child (para niños hasta 8/10 años)
(for children up to age 8/10)

50 x 30 x 6cm

Nota: Las almohadas QUIMERA están disponibles con una cubierta interior para facilitar la remoción de la cubierta exterior para lavado.
Note: The QUIMERA pillows are available with inner cover to facilitate the removal of the outer bag to wash.

HARPIAS

Copos de climalatex

Climalatex flakes



Harpías tradicional *traditional*
62 AL DO HA TR FL

Almohada tradicional hecha con 100% de espuma de látex anti ácaros é compuesta por copos de climalatex que permiten una mejor ventilación, proporcionando mayor frescura y manteniendo la suavidad de espuma de látex. La suavidad y la comodidad de la espuma de látex de alta calidad y durabilidad hecha de puro látex hacen este cojín higiénico y adaptable a cualquier posición mientras se duerme. Traditional pillow made with 100% Latex foam anti mites is composed of climalatex flakes that allow a better ventilation, providing greater freshness and maintaining the softness of latex foam. The softness and the comfort of the high quality Latex foam and durability made of pure Latex make this cushion hygienic and adaptable to any position while sleeping.

Dimensiones harpias tradicional: 50x33x12cm
Dimensions traditional harpias

Harpías viagem *travel*
62 AL VG HA M
62 AL VG HA M



El soporte cervical Harpias se ajusta perfectamente al contorno del cuello, o que permite un buen posicionamiento cervical al viajar, o simplemente cuando se necesita apoyo. Cojín con el exterior de terciopelo con composición de 50% safesleep y 50% poliéster con tejido de hilo de plata que confiere características antibacterianas, anti-fúngicas, anti-ácaros y antiestático. La tela tiene una textura suave. Interior en copos de látex o espuma de memoria (espuma viscoelástica, extremadamente moldeable y acogedora permitiendo reducir la presión sobre la piel y vasos sanguíneos, contribuyendo así a la mejor circulación flujo de sangre. La viscoelasticidad se adapta completamente el formato del cuerpo que proporciona una sensación de ligereza que resultan en un sueño muy tranquilo) para o perfecto ajuste al cervical. Harpias cervical support wraps perfectly to the outline of the neck, allowing a proper cervical positioning when travelling, or simply when you need support. Cushion with the Velvet exterior with composition of 50% safesleep and 50% polyester with silver thread fabric that gives antibacterial, anti-fungal anti-mite and anti-static characteristics. The fabric has a smooth texture. Interior in Latex flakes or MF (viscoelástico foam, extremely moldable and cozy allowing to reduce the pressure on the skin and on the blood vessels, thus contributing to better circulation of the blood flow. The viscoelasticity adapts completely the format of the body providing a sense of lightness that result in an extremely restful sleep) for the perfect neck adjustment.

Dimensiones Dimensions: 27x30x11cm

SÁBANAS-RESGUARDOS

MATRESS PROTECTION SHEETS

Con la composición de 75% algodón, 25% poliéster con un forro de PVC, las sábanas son impermeables y ajustables a su colchón.

With the composition of 75% cotton, 25% polyester with a PVC lining, the mattress protection sheets are waterproof and adjustable to your mattress.

Sábana resguardo *Matress protection sheet*

Dimensiones *Dimensions:*

100x200cm **63 LC RG 100**
150x200cm **63 LC RG 150**
180x200cm **63 LC RG 180**
200x200cm **63 LC RG 200**



ÍNDICE/ INDEX

COJINES Y PROTECCIÓN LOCALIZADA ANTI ESCARAS SEATS AND BED SORES PROTECTION SOFTSEAT

SOFTSEAT	2
BLUE GEL	3
RAMA DE SILICONA SILICONE RAW	5
PIEL SINTÉTICA SYNTHETIC SKIN	5

COLCHONES MATRESSES ANTI ESCARAS ESTÁTICOS BED SORES STATIC

NINFA	7
APOLO	8
ATHENA	8

HOSPITALARIOS HOSPITAL

HERA	9
URANO CUBOS	9

HOSPITALARIOS - CONFORT HOSPITAL - COMFORT

AFRODITE	11
EROS	11

EXTRA CONFORT EXTRA COMFORT

DUPLO LÁTEX DOUBLE LATEX	12
SUAVELIGHT	13
SUAVEVENUS	13
ZEUS	14
ADONIS	16

ALMOHADAS DE DORMIR SLEEPING PILLOWS

MEDUSA	18
QUIMERA	19
HARPIAS	20

SÁBANAS Y RESGUARDOS MATTRESS PROTECTION SHEETS

by **ORTHOS**
XXI
e u r o p e a n
i n c l u s i v e s o l u t i o n s

ORTHOSMAIA XXI

C/ Manuel Nuñez nº2 Ofic.9 Pl. 3 | 36203 Vigo | España
Tel: (+34) 886 312 806 | Móvil: (+34) 678 994 993 | E-mail: comercialespana@orthosxxi.com

ORTHOS XXI, Unipessoal Lda.

Rua de Santa Leocádia | 4809-012 Santa Leocádia de Briteiros | Guimarães | Portugal
Phone: (+351) 253 470 276/ 70/ 74 | Mobile: (+351) 936 199 005
E-mail: margarida.silva@orthosxxi.com | sofia.martins@orthosxxi.com
Fax: (+351) 253 470 278
info@orthosxxi.com
www.orthosxxi.com

CONTAINMENT

COMPENSATION

FUNCTIONALITY

POSICIONAMIENTO
POSITIONING

ORT
HOS

inclusive solutions
POSITIONING

COJINES POSTURALES POSTURAL PILLOWS

COJÍN POSTURAL EN VISCOELASTICO POSTURAL PILLOW IN MEMORY FOAM



Cojín postural semi cilíndrico
Semi cylindrical postural pillow
74 AL PO HE SC

Cojín postural semi cilíndrico Hermes, ideal para proteger su columna lumbar. Funda en terciopelo con tela antiácaros, antihongos, antibacteriano y antiestático. Interior en visco-elástico para máximo confort y para reducir la presión sobre la piel, manteniendo buena circulación sanguínea. Puede utilizarse bajo las rodillas, entre las rodillas, en los talones o como soporte lumbar.

Hermes, semi cylindrical postural pillow, ideal for protecting your lumbar spine. Velvet fabric cover, with antibacterial, anti-fungal anti-mite and anti-static characteristics. Interior in memory foam for maximum comfort, reducing the pressure on the skin, keeping in good condition the blood circulation. Can be used under the knees, between the knees, in lateral decubitus, under the back of the feet or as lumbar support.

Dimensiones *Dimensions*: 50x20x10cm

COJÍN POSTURAL IMPERMEABLE EN COPOS DE LÁTEX WATERPROOF POSTURAL PILLOW IN LATEX FLAKES



Cojín postural
Postural pillow
74 AL PO P/M/L

Cojín postural, ideal para proteger su columna lumbar. Funda bielástica, impermeable a los líquidos y permeable al aire, de fácil higienización. Interior en copos de látex, material que permite una excelente ventilación, hipoalergénico y que evita el crecimiento de bacterias, hongos y ácaros en su interior.

Postural pillow, ideal for protecting your lumbar spine. Bielastic cover, waterproof, breathable and easy hygiene. Interior in latex flakes, material that allows a excellent ventilation. Hypoallergenic, which prevents the growth of bacteria, fungi and dust mites.

Dimensiones *Dimensions*:

P/S 46x25cm pequeña small
M/M 46x30cm media medium
G/L 46x34cm gran large



Cojín postural apoyo decúbiteo para hombros, caderas y rodillas
Postural support pillow for shoulders, hips and knees
74 AL PO AP DE 1

Cojín postural apoyo decúbiteo para hombros, caderas y rodillas. Puede aplicarse en decúbiteo lateral. Funda bi-elástica impermeable y transpirable, de fácil higienización. Interior en copos de látex, material que permite una excelente ventilación. Hipoalergénico que evita el crecimiento de bacterias, hongos y ácaros.

Postural pillow for shoulders, hips and knees, Can be applied in lateral decubitus. Bielastic cover, waterproof, breathable and easy to clean. Interior in Latex flakes, material that allows a excellent ventilation. Hypoallergenic which prevents the growth of bacteria, fungi and dust mites.

Dimensiones *Dimensions*: 160cmx30cmØ



Cojín postural cilíndrico 52x20cm
Cylindrical postural pillow
74 AL PO CI

Cojín postural cilíndrico. Puede aplicarse en decúbiteo lateral. Funda bielástica impermeable y transpirable, de fácil higienización. Interior en copos de látex, material que permite una excelente ventilación. Hipoalergénico, evita el crecimiento de bacterias, hongos y ácaros. Puede utilizarse bajo las rodillas, entre las rodillas y en los talones.

Cylindric postural pillow. Can be applied in the lateral decubitus. Cover in bielastic fabric, waterproof, breathable and easy to clean. Interior in Latex flakes, material that allows a excellent ventilation. Hypoallergenic which prevents the growth of bacteria, fungi and dust mites. Can be used below the knees, between the knees and under the feet.

Dimensiones *Dimensions*: 52cmx20cmØ

CUÑAS POSTURALES POSTURAL WEDGES



Cuña en PU con capa en polipiel
PU wedge with polisoft cover
74 CU PU S
74 CU PU L

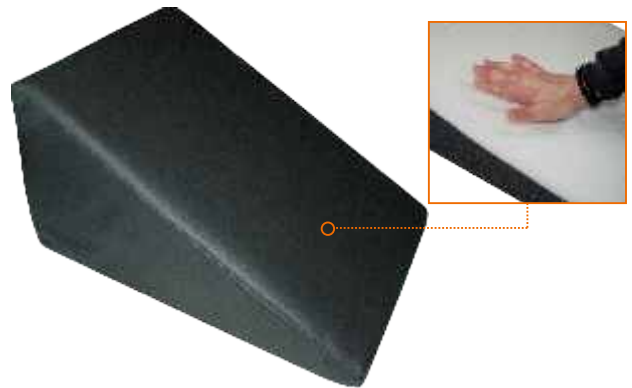

Cuña en PU con 2 cm en viscoelastico y capa en polipiel
PU wedge with 2cm in Memory Foam and polisoft cover
74 CU MF S
74 CU MF L

Cuñas posturales, entre otros beneficios, reducen el dolor de cuello, espalda y piernas, alivian algunos problemas respiratorios y mejoran la circulación. Ayudan a evitar la indigestión, azia y síntomas similares, ya que permiten elevar la cabeza en relación al cuerpo. Ideal también como ayuda en todas las etapas del embarazo. Perfectas para el levantamiento de las piernas cómodamente en diferentes ángulos. Pueden también utilizarse en el día a día para ver televisión, leer etc... Cuñas en 2 tamaños (grande y pequeño) con cubierta en polipiel, impermeable y permeable al aire, de fácil higienización y con dos tipos de composición interior (poliuretano o poliuretano y viscoelastico).

Postural wedges, among other benefits, reduce the pain on the neck, back, legs, and help in some respiratory problems and improve blood circulation. They help to avoid indigestion, heartburn and similar symptoms, because they allow to raise the head in relation to the body. Ideal also as an aid in all stages of pregnancy. Perfect for lifting the legs at different angles. Can also be used in day to day for watching TV, reading etc.. Available in 2 sizes (small and large) with polisoft cover, waterproof and breathable, easy to clean and with two types of interior composition (polyurethane or polyurethane and Memory Foam).

Dimensiones Dimensions:

S 60cmx45cmx15cm
L 60cmx45cmx30cm



Cuña lateral en PU con funda bielástica
PU lateral wedge with bielastic cover
74 CU PU U

Cuña lateral en viscoelastico con funda bielástica
Memory Foam lateral wedge with bielastic cover
74 CU MF V



Triángulo abductor en PU con funda bielástica
PU abductor triangle with bielastic cover
74 CU PU TR S/L

Cuñas laterales diseñadas para obtener un sueño confortable. Ayudan también a reducir diversos problemas causados por varices, mala circulación, calambres y síndrome aulladora. En doble uso son útiles para pacientes vasculares y diabéticos. Ayudan a reducir los problemas en caderas y espalda, optimizando la circulación sanguínea en las piernas y pies. Dos modelos disponibles, en poliuretano y en viscoelastico, con funda bielástica, impermeable a líquidos y permeable al aire, de fácil higienización.

Triángulo de abducción que se adapta perfectamente a la zona interna de los muslos. Ayuda a prevenir la aparición de escaras. Con funda bielástica, impermeable a líquidos y permeable al aire, de fácil higienización. Interior en espuma de alta densidad. Dos tamaños disponibles.

Abduction triangle that adapts perfectly to the inside zone of the thighs. Helps to prevent the appearance of bed sores. With bielastic cover, waterproof and breathable, easy to clean. Interior in high density foam. Two sizes available.

Lateral wedges designed to obtain a comfortable sleep. Also help to reduce various problems caused by varicose veins, poor circulation, cramping and restless legs syndrome. In double use are useful for vascular and diabetic patients. They help to reduce problems in the hips and back, optimizing the blood flow in the legs and feet. Two models available in polyurethane and Memory Foam, with bielastic cover, waterproof and breathable, easy to clean.

Dimensiones Dimensions:

S 30x23/15x15cm
L 40x36/15x15cm

Dimensiones Dimensions:

70cmx15cmx15cm

ADJUST BELTS

CINTURONES DE POSICIONAMIENTO

POSITIONING BELTS

Cinturones de posicionamiento ADJUST BELTS de ORTHOS XXI, diseñados para permitir la máxima comodidad y un posicionamiento correcto del usuario. Con materiales de calidad excepcional y atención a los detalles. Tenemos una amplia gama que permite responder a las necesidades de customización. Con tres tipos de acabados para elegir: polipiel, tela abeja y neopreno.

Positioning belts ADJUST BELTS of ORTHOS XXI, designed to allow maximum comfort and proper placement of the user. with exceptional materials and quality details. We have a wide range that allows us to respond to customized needs. With three finishings to choose from: polisoft, 3D and neoprene.

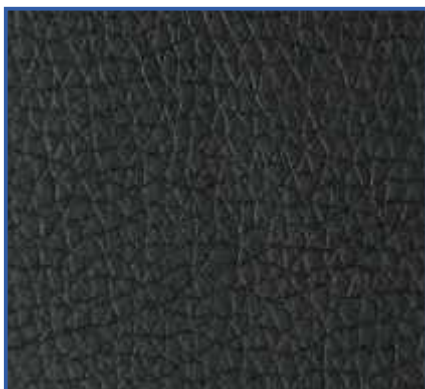

POLIPIEL POLISOFT

Material resistente y duradero, con funda doble de vinilo de polipiel, acabado polipiel. Fácilmente lavable.

Resistant and durable material, with double layer of polisoft vinyl, skin type finish. Easily washable.

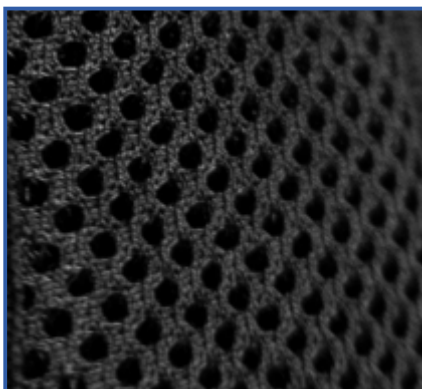

TELA ABEJA 3D

Tejido de tela abeja, material acolchado y transpirable, muy cómodo en contacto con el cuerpo. Lavable.

Bee fabric, quilted and breathable material, very comfortable in contact with the body. Washable.



NEOPRENO NEOPRENE

Proporciona la elasticidad adecuada para un movimiento controlado y cómodo para el usuario. repele el agua y suciedad. Fácilmente lavable.

Provides the elasticity suitable for a controlled motion and comfortable for the user. Repels the water and dirt. Easily washable.

POSICIONADORES DE TRONCO TRUNK POSITIONERS

Posicionadores de tronco ADJUST BELTS de ORTHOS XXI facilitan el correcto posicionamiento del tronco, proporcionando un soporte dinámico esencial para un buen aliento, posición de cabeza y funcionalidad. Posicionadores con hebillas de ajuste rápido de tensión en nylon para mayor resistencia y durabilidad. Modelos con y sin bloqueo central.

Trunk positioners ADJUST BELTS of ORTHOS XXI facilitates the correct positioning of the trunk, providing a dynamic support essential for a good breathing, head positioning and functionality. Positioners with nylon quick fit tension buckles for a better resistance and durability. Models with and without central locking.

SOPORTE DE TRONCO-HOMBRE MAN'S TRUNK SUPPORT



Soporte de tronco polipiel hombre
Polisoft man's trunk support
75 SP TR SF PO H S/M/L/XL



Soporte de tronco tela abeja hombre
3D man's trunk support
75 SP TR SF 3D H S/M/L/XL



Soporte de tronco neopreno hombre
Neoprene man's trunk support
75 SP TR SF NP H S/M/L/XL



Soporte de tronco con zip polipiel hombre
Polisoft man's trunk support with zip
75 SP TR CF PO H S/M/L/XL



Soporte de tronco con zip 3D hombre
3D man's trunk support with zip
75 SP TR CF 3D H S/M/L/XL

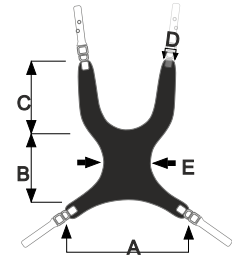

Medidas soporte de tronco hombre
Man's trunk support sizes

Tamaño	A	B	C	D	E
size M	30cm	17cm	20cm	5cm	13cm
L	37cm	21cm	23cm	6cm	14cm
XL	44cm	25cm	26cm	6cm	16cm

SOPORTE DE TRONCO-MUJER WOMAN'S TRUNK SUPPORT



Soporte de tronco polipiel mujer
Polisoft woman's trunk support
75 SP TR SF PO M M/L/XL



Soporte de tronco tela abeja mujer
3D woman's trunk support
75 SP TR SF 3D M M/L/XL



Soporte de tronco neopreno mujer
Neoprene woman's trunk support
75 SP TR SF NP M M/L/XL



Soporte de tronco con zip tela abeja mujer
3D woman's trunk support with zip
75 SP TR CF 3D M M/L/XL



Soporte de tronco con zip polipiel mujer
Polisoft woman's trunk support with zip
75 SP TR CF PO M M/L/XL

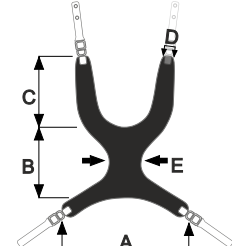

Medidas soporte de tronco mujer
woman's trunk support sizes

Tamaño	A	B	C	D	E
size S	23cm	13cm	17cm	5cm	4cm
M	30cm	17cm	20cm	5cm	4cm
L	37cm	21cm	23cm	6cm	4cm
XL	44cm	25cm	26cm	6cm	4cm

SOPORTE DE TRONCO-NIÑO CHILD TRUNK SUPPORT



Soporte de tronco polipiel niño
Polisoft child trunk support
75 SP TR SF PO H XS



Soporte de tronco neopreno niño
Neoprene child trunk support
75 SP TR SF PO H S

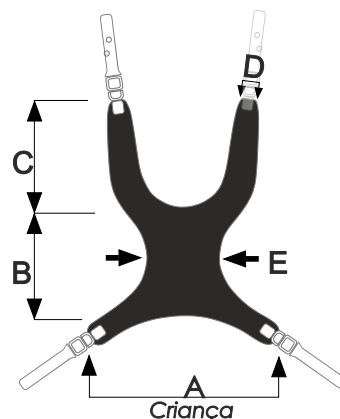

Medidas soporte de tronco niño
Child trunk support sizes

Tamaño	A	B	C	D	E
Size XS	16cm	11cm	13cm	4,5cm	9,5cm
S	23cm	13cm	17cm	5cm	12cm

ARNÉS DE HOMBROS-UNISEX UNISEX-SHOULDER HARNESS



Arnés de hombros neopreno
Neoprene shoulder harness
75 AR OB NP S/M/L/XL



Arnés de hombros tela abeja
3D shoulder harness
75 AR OB 3D S/M/L/XL

Elija arnés de hombros Choose shoulder harness:
mida la anchura de los hombros. Si el ancho de los
hombros difere en nuestra tabla, considerar otros
factores como el crecimiento, cambios en peso y
ropa.

Measure the width of the shoulders. If the width of the
shoulders differs in our table, consider other factors
such as growth, changes in weight and clothes.

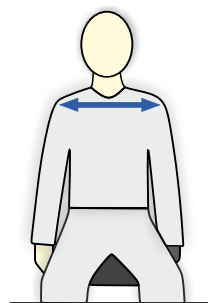

Medidas de referencia
arnés de hombros:
Reference measures
shoulder harness:

XS	25cm-28cm
S	28cm-33cm
M	33cm-41cm
L	41cm-48cm
XL	48cm-56cm

CINTURÓN DE PECHO CHEST BELT



Cinturón de pecho tela abeja
Con cierre de lado
3D chest belt with side zip
75 CP PT 3D S/M/L



Cinturón de pecho polipiel con cierre de lado
Polisoft chest belt with side zip
75 CP PT PO S/M/L

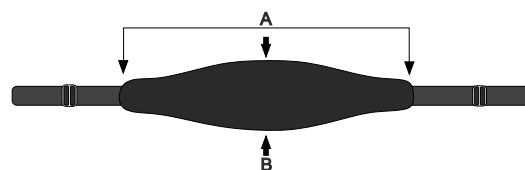

Medidas cinturón de pecho
Chest belt sizes

Tamaño	A	B
Sizes S	40cm	10cm
M	50cm	12cm
L	60cm	13cm



Cinturón de pecho tela abeja
Con cierre de lado niño
3D child's chest belt with side zip
75 CP PT 3D S

POSICIONADORES PÉLVICOS PELVIC POSITIONERS

Cinturones pélvicos ADJUST BELTS de ORTHOS XXI, diseñados para ayudar en el posicionamiento de la pelvis aumentando la movilidad. Cierre en la parte frontal y hebillas de ajuste en las laterales para comodidad de los usuarios y profesionales de la salud. En neopreno, material con alguna elasticidad, repelente al agua y al suciedad y fácilmente lavable.

Pelvic belts ADJUST BELTS of ORTHOS XXI, designed to assist in the placement of the pelvis by increasing mobility. Front buckle and lateral adjustment straps for the convenience of the users and health professionals. Neoprene fabric, with some elasticity, water and dirt repellent and easily washable.



Cinturón pélvico neopreno ajuste doble 4 puntos de fijación
Neoprene pelvic belt double fit with 4 points of fixation
75 CP PV 4P NP M/L



Cinturón pélvico neopreno ajuste doble 2 puntos de fijación
Neoprene pelvic belt double fit with 2 points of fixation
75 CP PV 2P NP M/L

Elija cinturón pélvico Choose the pelvic belt:

Medir el ancho de la cadera alrededor del gran trocánter con la persona sentada. Si el ancho de cadera difiere entre los in nuestra tabla, considerar otros factores como el crecimiento, cambios de peso y ropa.

Measure the width of the hip around the gran trochanter with the person sitting. If the hip width differs in our table, consider other factors such as growth, changes in weight and clothes.

Medidas de referencia Reference measures:

- M 23cm-38cm
- L 33cm-48cm

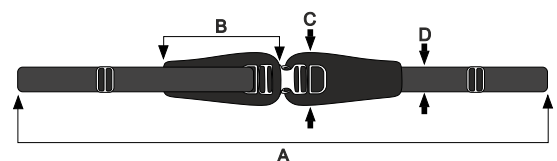

Medidas Sizes

Tamaño Sizes	A	B	C	D
M	160cm	20cm	8cm	4cm
L	170cm	25cm	8cm	4cm

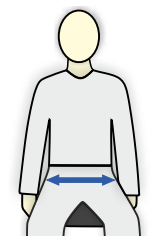

Arneses pélvicos ADJUST BELTS de ORTHOS XXI, diseñados para almacenar cada pierna en la parte interior del muslo ofreciendo una excelente resistencia a la rotación del pelvis sin limitar el movimiento posterior ni ejercer presión sobre el vejiga. En tela de 3 dimensiones (tela abeja), material acolchado y transpirable, muy comfortable en contacto con el cuerpo. Lavable.

Pelvic harnesses ADJUST BELTS of ORTHOS XXI, designed to hold each leg in the inner part of the thigh, offering an excellent resistance to rotation of the pelvis without limiting the posterior movement neither exert pressure on the bladder. In 3 dimensions fabric (3D), quilted and breathable material, very comfortable in contact with the body. Washable.



Arnés pélvico standard
Tela abeja
3D standard pelvic harness
75 AR PV ST 3D M/L/XL

Arnés pélvico en T
Tela abeja
3D pelvic harness in
75 AR PV T 3D M/L/XL

Arnés pélvico en V
Tela abeja
3D pelvic harness in V
75 AR PVV 3D M/L/XL

Elija arnés pélvico Choose pelvic harness:

La medida entre la espina ilíaca anterior-superior hasta el punto donde la parte interior del muslo toca en el asiento.

The measurement between the anterior superior iliac spine up to the point where the inner part of the thigh touches on the seat.

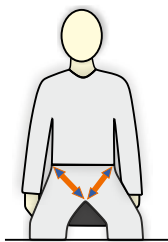

Medidas de referencia Reference measures:

S	20cm-28cm
M	28cm-36cm
L	36cm-41cm
XL	41cm-45cm

Medidas arnés pélvico standard Standard pelvic harness sizes

Tamaño Size	A	B	C
S	25cm	45cm	20cm
M	30cm	52cm	25cm
L	35cm	56cm	28cm
XL	40cm	60cm	30cm

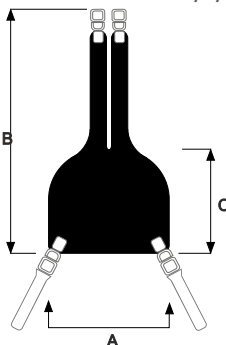

ACCESORIOS ACCESSORIES

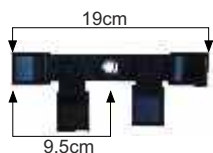

Faja de fijación 4 puntos para sillas de ruedas 25mm
25mm 4 points fixing strap for wheelchairs
99 75 FX 4P CD

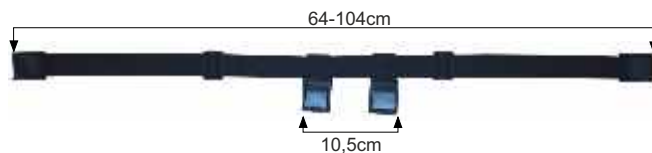

Faja de fijación 4 puntos para sofá 25mm
25mm 4 points fixing strap for sofa
99 75 FX 4P SF



Precinta fija con cierre click 25mm (par)
25mm strap with click buckle (pair)
99 75 PC FX FC 25



Precinta elástica con cierre click 25mm (par)
25mm elastic strap with click buckle
99 75 PC EL FC 25



Precinta con cierre rotativo 25mm (par)
25mm strap with rotating buckle
99 75 PC FX FR 25



Palanca 25mm con fijación tornillo
25mm lever with screw buckle
99 75 AL

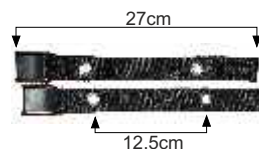

Precinta fijación multifuncional con palanca 25mm (par)
25mm strap with multifunctional lever buckle
99 75 PC MT AL 25

POSICIONADORES EXTREMIDADES LIMBS POSITIONERS

INFERIORES Y SUPERIORES LOWER AND UPPER

Posicionadores de extremidades inferiores y superiores *ADJUST BELTS* de *ORTHOS XXI*, diseñados para posicionar adecuadamente los miembros. Con dos tipos de materiales: en tela de 3 dimensiones (tela abeja), material acolchado y transpirable, muy confortable en contacto con el cuerpo y en neopreno que proporciona a elasticidad adecuada para un movimiento controlado y confortable al usuario, repelente del agua y suciedad y fácilmente lavable.

Lower and upper limbs positioners ADJUST BELTS of ORTHOS XXI, designed to position the limbs adequately. With two types of materials: in 3 demensions (3D), quilted and breathable material, very comfortable in contact with the body and in neoprene which provides elasticity suitable for a controlled motion and comfortable for the user, water and dirt repellent. Easily washable.



cinturón de muñeca elástica neopreno M/L (par)
neoprene elastic wrist belt M/L (pair)
75 CP PU M/L



Sandalia base metálica sin fijación anterior
en tela abeja/Neopreno M/L

Metalic base sandal without anterior buckle in 3D/Neoprene M/L

tamaños disp. sizes available 34/35/37/45/50

99 51 SD SF 3D 34/35/37/45/50

99 51 SD SF NP 34/35/37/45/50



Sandalia base metálica con fijación anterior
en tela abeja/Neopreno M/L

Metalic base sandal with anterior buckle in 3D/Neoprene M/L

tamaños disp. sizes available 34/35/37/45/50

99 51 SD CF 3D 34/35/37/45/50

99 51 SD CF NP 34/35/37/45/50



Posicionador de calzado base termomoldado
con fijación anterior

Termomoulded shoe positioner with anterior buckle

tamaños disp. sizes available 34/35/37/45/50

99 53 PS CF 34/35/37/45/50



Posicionador de calzado base termomoldado
sin fijación anterior

Termomoulded shoe positioner without anterior buckle

tamaños disp. sizes available. 34/35/37/45/50

99 53 PS SF 34/35/37/45/50



Soporte de gemelos
Gastrocnemius support

99 51 SP GM

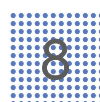

CALCETINES PARA DIABÉTICOS

DIABETIC SOCKS

Acanelado extensible del parte superior para evitar el deslizamiento de las calcetines.
Corrugated extensible of the superior part to prevent the slipping of the sock.



Sin bordadura superior
without superior embroider

Técnica especial de fabricación forma una barrera en los tobillos que impiede la formación de arrugas o pliegues.
Special manufacture technique that forms a barrier in the ankles that prevents the formation of wrinkles or creases

La costura es plana y discreta ayuda a anular la presión en los dedos
The seam is flat and discreet voiding the pressure on the fingers

Tamaños sizes:

- S 37-39
- M 40-42
- L 43-45



Algodón normal blanco
White normal cotton
66 MD AG NO 09 S/M/L



Algodón normal negro
Black normal cotton
66 MD AG NO 02 S/M/L



Algodón cardado blanco
White carded cotton
66 MD AG CA 09 S/M/L



Algodón cardado negra
Black carded cotton
66 MD AG CA 02 S/M/L

Lana normal blanca
White normal wool
66 MD LA NO 09 S/M/L

Lana normal negra
Black normal wool
66 MD LA NO 02 S/M/L

Lana cardada blanca
Black carded wool
66 MD LA CA 09 S/M/L

Lana cardada negra
Black carded wool
66 MD LA CA 02 S/M/L



Algodón cardado
 Anti slip blanco
Anti slip carded cotton white
66 MD AG CA AD 09 S/M/L



Detalle base anti slip
Anti slip base detail



Algodón cardado
 Anti slip negro
Anti slip carded cotton black
66 MD AG CA AD 02 S/M/L

ÍNDICE/ INDEX

CONTROL POSTURA POSTURAL CONTROL

COJÍNES POSTURALES 1
POSTURAL PILLOWS

CUÑAS POSTURALES 2
POSTURAL WEDGES

ADJUST BELTS 3

CONTURONES DE POSICIONAMIENTO POSITIONING BELTS

POSICIONADORES DE TRONCO 4
TRUNK POSITIONERS

ACCESORIOS 7
ACCESSORIES

POSICIONADORES EXTREMIDADES INFERIORES Y 4
SUPERIORES 8
LOWER AND UPPER LIMBS POSITIONERS

**CALCETINES PARA DIABÉTICOS 9
DIABETICS SOCKS**



ORTHOSMAIA XXI

C/ Manuel Nuñez nº2 Ofic.9 Pl. 3 | 36203 Vigo | España
Tel: (+34) 886 312 806 | Móvil: (+34) 678 994 993 | E-mail: comercialespana@orthosxxi.com

ORTHOS XXI, Unipessoal Lda.

Rua de Santa Leocádia | 4809-012 Santa Leocádia de Briteiros | Guimarães | Portugal
Phone: (+351) 253 470 276/ 70/ 74 | Mobile: (+351) 936 199 005
E-mail: margarida.silva@orthosxxi.com | sofia.martins@orthosxxi.com
Fax: (+351) 253 470 278
info@orthosxxi.com
www.orthosxxi.com



ROBUSTNESS

DURABILITY

REINFORCEMENT

BARIATRIA
BARIATRICS

**ORT
HOS**

inclusive solutions
BARIATRICS

HISTORIA HISTORY

ORTHOS XXI es un fabricante europeo, ubicado en Portugal, perteneciente al universo del material ortopédico y hospitalario. Creada en 2007, ORTHOS XXI sucede a ORTOMAIA, cuya actividad empezó en el año 1985. A lo largo de su trayecto de más de 30 años, ORTHOS XXI ha crecido y se ha consolidado, haciéndose una empresa reconocida y respetada, convirtiéndose incluso en un punto de referencia para muchos. De cara al futuro, hemos inaugurado recientemente un nuevo pabellón, duplicando así las instalaciones productivas.

ORTHOS XXI añade a su condición de fabricante europeo con un amplio catálogo propio, la distribución de los productos de reputadas empresas nacionales e internacionales. Pretendemos así consolidar nuestra posición de one stop shop de cercanía, explotando en simultaneo la vertiente de las necesidades especiales.

ORTHOS XXI participa regularmente en actividades internacionales de promoción y comercio, en Ferias y Congresos en el sector de la Salud, así como en misiones empresariales en varios países de Europa y en los Continentes Americano y Africano.

ORTHOS XXI is an European manufacturer located in Portugal, belonging to the universe of orthoepedic and hospital materials. Founded in 2007, ORTHOS XXI succeeds ORTOMAIA, which activity began in 1985. Through these more than 30 years, ORTHOS XXI has grown and consolidated, converting itself into a recognised and respected company, a reference for many, even. Towards the future, we have recently inaugurated a new pavillion thereby doubling our production facilities.

ORTHOS XXI adds to its condition as an European manufacturer of an ever growing range of products, the distribution of products from reputed national and international companies, through agreements with them. We aim at consolidating our position as a vicinity one stop shop, simultaneously exploiting the special needs' aspect.

ORTHOS XXI regularly participates in international promotion and trade activities, in Exhibitions and Congresses in the Health sector, as well as in business missions, namely in a number of European countries, America and Africa.

VALORES VALUES

Nos mueve la convicción de que, con nuestra labor, contribuimos diariamente para la mejora de la calidad de vida y para la satisfacción de las necesidades de los usuarios de nuestros productos y servicios. Priorizamos una actitud de trabajo en equipo, flexibilidad y mejora continua. Consideramos fundamental una constante inversión en innovación y desarrollo de los productos, contando actualmente con un equipo dedicado exclusivamente a esta finalidad.

Estos valores soportan la presentación, en este nuevo catálogo, de algunas de las novedades desarrolladas más recientemente y, a la par, dar respuesta a las necesidades personalizadas de los usuarios.

We are moved by the belief that, through our work, with our products and services, we daily contribute towards the improvement of end users' life quality and the satisfaction of their needs. We value a team work, flexibility and continuous improvement attitude. We believe it is vital to have a continuous investment in innovation and development of our products, thereby currently having a dedicated team for that purpose.

These values enable us to present, in this catalogue, some of the latest developments and, in parallel, to provide customised solutions to the end users' needs.

CALIDAD QUALITY

La calidad de los productos de ORTHOS XXI puede ser confirmada en los mejores hospitales e instituciones, donde nos han elegido. La mayoría de nuestros productos son dispositivos médicos de clase 1 y ostentan el marcado CE, según las Directivas Comunitarias 93/42/CEE y 2007/47/CE y están registrados en la Autoridad competente, Infarmed. Son testados por entidades acreditadas e independientes, como el IBV (Instituto de Biomecánica de Valencia, en España). La empresa está también certificada según la norma EN ISO 9001:2008.

El valor y la cualificación de los recursos humanos a través de la implementación de actividades de entrenamiento y actualización en distintas áreas han sido fuertes apuestas de nuestra empresa. ORTHOS XXI tiene como principal preocupación la mejora continua de los procesos productivos y de los servicios, así como la mejora de la calidad de sus productos, lo que nos permite satisfacer cada vez mejor las necesidades y exigencias de clientes y usuarios.

The quality of ORTHOS XXI's products can be confirmed in the best hospitals and institutions, where they have been preferred. Most of them are Class 1 Medical Devices, CE marked in accordance with European Directives 93/42/CEE and 2007/47/CE and registred in the competent Authority, to Infarmed. Many are tested by well renowned and independent entities, namely IBV (Instituto de Biomecanica de Valencia, in Spain). The company is also certified in accordance to the EN ISO 9001:2008 Standards.

The qualification of ORTHOS XXI's human resources, through the implementation of training in various areas, has been a strong stake. ORTHOS XXI's main concerns are to continuously improve its productive processes and services as well as the quality of its products, so as to better satisfy our costumers and end user's needs and demands.

BARIATRÍA

BARIATRICS

Bariatría es la rama de la medicina que se ocupa de las causas, prevención y tratamiento de la obesidad. El término bariatría fue creado en 1965, de la raíz griega bar- ("peso" como en el barómetro), sufijo -iatr ("tratamiento," como en Pediatría) y el sufijo -ía ("relacionados con"). El campo abarca dieta, enfoques de ejercicio y terapia conductual para pérdida de peso, así como tratamiento farmacológico y cirugía. El sobrepeso y la obesidad están aumentando los problemas médicos de proporciones de pandemias. Hay muchos efectos perjudiciales sobre la salud de la obesidad: los individuos con un IMC (índice de masa corporal) superior a un rango saludable tienen un mucho mayor riesgo de problemas médicos. Estos incluyen enfermedades del corazón, diabetes, varios tipos de cáncer, asma, apnea obstructiva del sueño y problemas osteomusculares crónicos. También es un efecto en la mortalidad la obesidad. Personas pueden pensar que es difícil perder peso por su cuenta. Es común que personas que han intentado dietas rápidas tengan concluido que han subido de peso, o han regresado a su peso original, después de dejar la dieta. Aunque dieta, ejercicio, terapia de comportamiento y drogas anorexígenas son tratamientos de primera línea, el tratamiento médico para la obesidad severa tiene éxito limitado a corto plazo y éxito a largo plazo muy pobre. Cirugía de pérdida de peso generalmente resulta en una mayor pérdida de peso que el tratamiento convencional y conduce a mejoras en la calidad de vida y obesidad relacionados con enfermedades como hipertensión y diabetes. La combinación de enfoques utilizados puede adaptarse a cada paciente.



Bariatrics is the branch of medicine that deals with the causes, prevention, and treatment of obesity. The term bariatrics was created around 1965, from the Greek root bar- ("weight," as in barometer), suffix -iatr ("treatment," as in pediatrics), and suffix -ic ("pertaining to"). The field encompasses dieting, exercise and behavioral therapy approaches to weight loss, as well as pharmacotherapy and surgery. Overweight and obesity are rising medical problems of pandemic proportions. There are many detrimental health effects of obesity: Individuals with a BMI (Body Mass Index) exceeding a healthy range have a much greater risk of medical issues. These include heart disease, diabetes, many types of cancer, asthma, obstructive sleep apnea, and chronic musculoskeletal problems. There is also an effect of obesity on mortality. People may find it difficult to lose weight on their own. It is common for dieters to have tried fad diets only to find that they gain weight, or return to their original weight, after ceasing the diet. Although diet, exercise, behavior therapy and anti-obesity drugs are first-line treatment, medical therapy for severe obesity has limited short-term success and very poor long-term success. Weight loss surgery generally results in greater weight loss than conventional treatment, and leads to improvements in quality of life and obesity related diseases such as hypertension and diabetes. The combination of approaches used may be tailored to each patient.



PENINSULAR XXL



PENINSULAR XXL
73 CD 3 PE



El refuerzo colocado en los asientos ofrece al usuario una silla adaptable. Asientos en espuma de poliuretano de alta densidad y viscoelásticos forrados a tela de nylon. Respaldo en nylon para mejor ajuste y comodidad. Apoya brazos anatomicos ajustables de 20 a 30cm. Reposapiés desmontables. Ruedas traseras rayadas de 600mm e delanteras de 200mm. Todos los tornillos tienen tuercas autoblocantes que impiden el desprendimiento.

The reinforcement placed in the seat offers the user an adaptable chair to your size. High-density polyurethane foam seat and viscoelastic lined to the nylon fabric. Backrest in nylon for better adjust and comfort. Anatomic armrests adjustable from 20 to 30cm. Detachable footrest. 600mm spokes rear wheels and 200mm front wheels. All bolts have self blocking nuts that prevent the loosening of them.



PENINSULAR XXL 70	-	70	112	77	51	46	108	88	50	400
PENINSULAR XXL 75	-	75	112	77	51	46	108	88	50	400
PENINSULAR XXL 80	-	80	112	77	51	46	108	88	50	400

ANTARCTIC XXL

Antarctic 73 CD I AN XXL

Silla sanitária en acero inoxidable de alta resistencia. Asiento y espalda en resina fenólica. Tiene 4 ruedas de 100mm en acero inoxidable. También disponible con ruedas traseras de 600mm. Permite la colocación de la silla en el WC y el uso de la misma.

Sanitary seat in high strength stainless steel. Seat and backrest in phenolic resin. Has 4 100mm castors in stainless steel. Also available with 600mm rear wheels. It allows placing the chair on the toilet and using it.



Antarctic xxl 4 rodesnos
XXL antarctic 4 castors
73 CD I AN XXL RR



Antarctic XXL rueda grande
XXL antarctic 600mm wheels
73 CD I AN XXL RG



ANTARCTIC 4 RODIZIOS
ANTARCTIC RODA GRANDE

-	100	250	-	-	50	50	-	-	50
-	100	250	-	-	50	50	-	-	50

EUPHORIA XXL

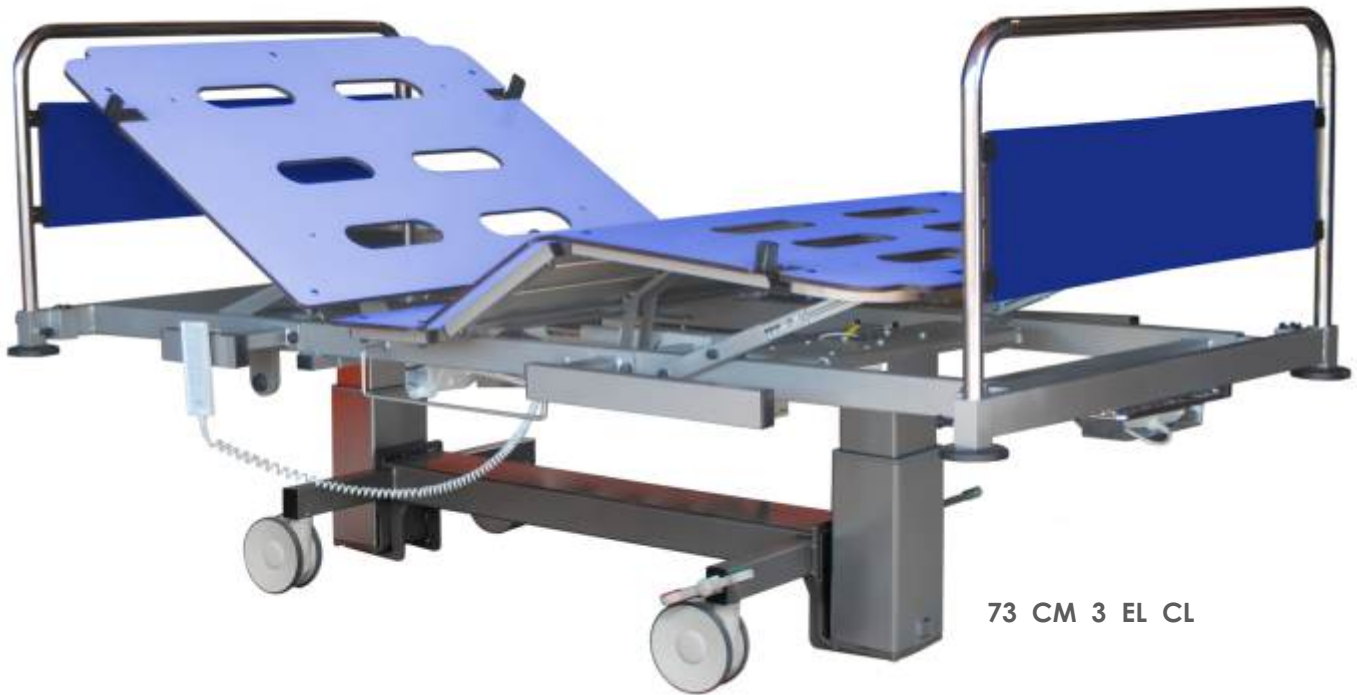

73 CM 3 EL CL



Opciones cabecero piecero:
Head and footboards options:

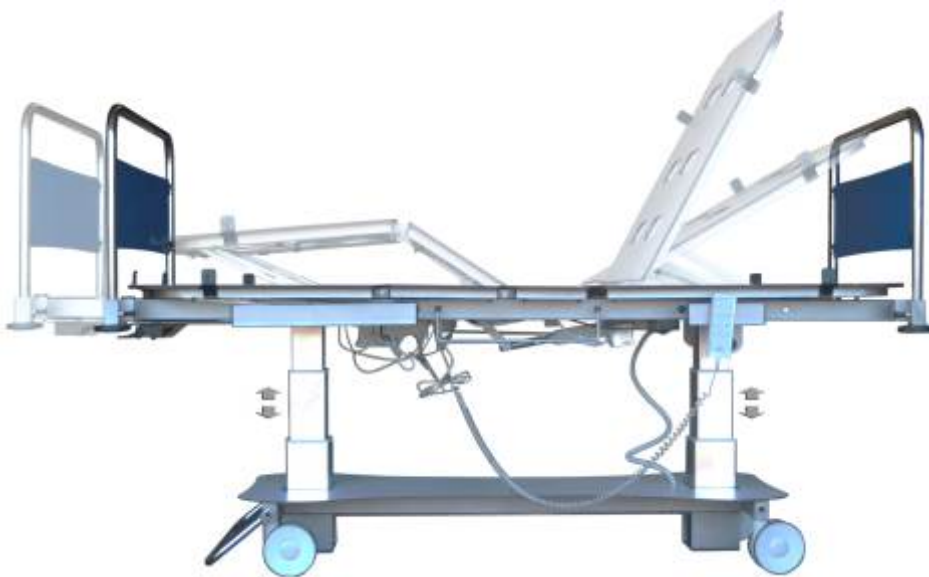

CAMA EUPHORIA XXL

EUPHORIA, cama hospitalaria recomendada para uso en unidades de cuidados intensivos y otros servicios con riesgo bacteriológico elevado. Con componentes adecuados a medio hospitalario, de fácil limpieza y higienización. Somier de 4 planos articulados, con sistema de columnas para la elevación y el Tren y Antitrendelemburg. Estructura preparada para barandillas bipartidas.

SOMIER

Somier con cuatro planos (sección pélvica fija y 3 secciones articuladas) con estructura en acero y lecho en fenólico. Estética y funcionalmente práctico, ligero, fuerte y de fácil desinfección y con agujeros para mejor ventilación del colchón. Equipado con protector de colchón redondeado, lavable y desinfectable para mantener el colchón en su lugar. La pintura epoxy es resistente a los ultravioletas y presenta un grado de resistencia a la niebla salina de 1000h (prueba realizada en conformidad con las normas ASTM B117 sin ninguna señal visible de corrosión). Estructura preparada para acoplar distintos accesorios.

CONTROL ELÉCTRICO

Mando eléctrico para accionamiento del respaldo y de piés con 2 motores. Sistema de columnas con motores independiente para ajuste en altura (43-83cm) y para Tren y Antitren con 18°/18°. Permite posiciones Fowler y Semi-fowler y silla cardíaca.

(Opción) CPR

(Opción) Mando de enfermera con movimientos de bloqueo

Batería de emergencia estándar

SISTEMA DE ELEAR CON TREN Y ANTI-TRENDELEMBERG

Sistema de elevación con columnas eléctricas y base en acero con ruedas dobles de 150mm con freno centralizado, con una rueda antiestática y 1 rueda direccional. Para mayor seguridad, los pedales tienen señalización (verde y rojo) para indicar bloqueo de ruedas. Las ruedas dobles de 150mm proporcionan una mayor estabilidad y resistencia al rodamiento. Con bajo nivel de ruido, excelente resistencia al desgaste y buena protección contra la oxidación.

XXL EUPHORIA BED

EUPHORIA hospital bed recommended for use in intensive care units and any other units with high bacteriological risk. Its components are suitable for hospital environment, easy to clean and disinfect. Four-sections mattress, available with 2 columns system for elevation and Trendelemburg and reverse. Structure prepared for two-parts side rails.

MATTRESS SUPPORT

4-Section mattress support (fixed pelvic section and 3 articulated sections) with steel structure and phenolical sections and head and foot boards. Aesthetically appealing and functionally practical, light and strong, easily disinfectable, with holes for better mattress ventilation. With rounded, washable and disinfectable mattress guards to hold the mattress into place. Epoxy painted steel structure, resistant to ultra-violet rays presenting 1000h resistance to saline mist (test carried out in accordance with ASTM B117 standards, without any visible signs of corrosion). Structure prepared for a wide range of accessories.

ELECTRICAL CONTROL

Pushbutton electric control to actuate the mattress sections, with 2 motors

Columns system with 2 independent motors for height adjustment (42-76cm) and for Trendelemburg and Reverse (18°/18°).

Fowler and Semi-Fowler and cardiac chair positions.

(Option) CPR

(Option) Nurse station with locking function

Standard emergency battery

ELEVATION AND TRENDELEMBERG AND REVERSE SYSTEM

Elevation system with 2 electric columns and base manufactured in steel with 150mm double wheels with central brakes, one antistatic wheel and one directional wheel. For greater safety, the pedals have signage (green/red) to indicate wheels lockage. The 150mm double wheels provide greater stability and rolling resistance. Low noise level, excellent wear resistance and good protection against oxidation.

EUPHORIA XXL

Lecho en fenólico cab/piecer en acero/fenólico Phenolical mattress support and steel/phenolical head/foot boards

Dispositivo médico de clase 1 (CEE Directiva 93/42) Medical device of 1 class (EEC Directive 93/42)	
Dimensiones (sin barandillas) Dimensions (without side rails)	220x100cm
Dimensiones plataforma del colchón Dimensions of the mattress platform	210x90cm
Ajustable en altura Height adjustable	40-80cm
Sección del respaldo - ángulo de inclinación Back section support - inclination angle	0°-70°
Sección del respaldo - auto regresión Back section support - auto regression	0-9cm
Sección de los muslos - ángulo de inclinación Thighs section - elevation angle	0°-45°
Trendelenburg y Anti Trendelenburg Trendelenburg and Anti Trendelenburg	18°/18°
Peso máximo del paciente Maximum patient weight	250kg
Máxima carga admisible de seguridad Maximum permissible load of security	285kg
Carga estática Static load	400kg

COLCHÓN ANTI ESCARAS BEDSORES PREVENTION MATTRESS

NINFA XXL

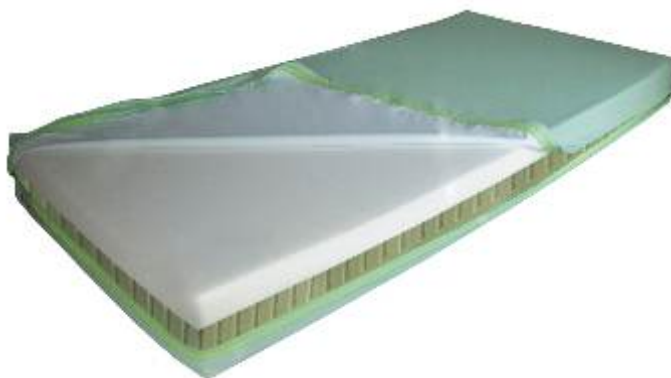
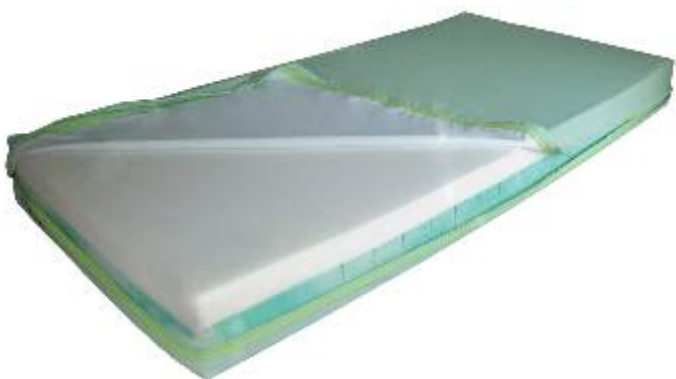

Colchón anti escaras Ninfa XXL
Ninfa XXL bedsores prevention mattress
Dimensiones dimensions: 215x107x17cm
73 CL NI 017 PU

Colchón anti escaras Ninfa latex XXL
Ninfa latex XXL bedsores prevention mattress
Dimensiones dimensions: 215x107x15cm
73 CL NI 017 PU

Colchón construido con 5cm de Memory Foam +12cm de Látex D80, para usuarios con un peso corporal mayor que 85kg. Colchón de 100% látex, excelente para una buena ventilación. Es un colchón articulable, reversible con 2 lados iguales. El látex es un material hipodérmico que impide por supuesto, el crecimiento de bacterias, hongos y ácaros en su interior. Es un material firme, flexible y elástico, que permite un correcto apoyo espinal facilitando la circulación sanguínea. Tienen una gran longevidad.

Memory Foam: Espuma viscoelástica muy acogedor y plegable que permite una reducción comprobada de presión sobre la piel y los vasos sanguíneos, contribuyendo así para la mejor circulación sanguínea. La espuma viscoelástica se adapta completamente a la forma del cuerpo proporcionando una sensación de ligereza que resultan en un sueño muy tranquilo.

Soyafoam: Espuma utilizada como base de apoyo. Es un poliuretano innovador, porque es una espuma ecológica, hecho con base en la soja.

Tela interior: Tela en malla 50% Algodón, 50% Poliéster, con cierre. Es opcional. Nunca debe ser eliminada

Matress built with 5cm of Memory Foam + 12cm Latex D80, for users with body weight greater than 85kg. Matress built with 100% Latex, great for a good ventilation. Is a articulable, reversible with 2 equal sides mattress. The Latex is a hypoallergenic material that prevents the growth of bacteria, fungi and dust mites in its interior. It is a firm, elastic and flexible material witch allows a correct spinal support and facilitates the blood circulation. The Latex material has a great longevity.

Memory Foam: Viscoelastic foam, extremely moudable and cozy that alloys a proven reduction of the pressure on the skin and blood vessels, thus contributing for a better blood circulation. The viscoelastic foam adapts completely to the shape of the body providing a sense of lightness that result in a extremely restful sleep.

Soyafoam: Foam used as base of support. Is an innovative polyurethane because it is an ecological foam, made based on soy.

Inside cover: Fabric cover 50% cotton, 50% Polyester, with Zip. Is optional. When exists, should never be removed.



Extensión de 30cm para colchón Ninfa XXL
30cm extension for XXL Ninfa mattress
73 EX CL NI
Extensión de 30cm para colchón Ninfa Latex XXL
30cm extension for XXL Ninfa Latex mattress
73 EX CL NI LT



Cojín de latex y memory foam XXL
Latex and memory foam pillow
73 AL LT MM XL

MESILLA DE NOCHE XXL

XXL BEDSIDE TABLE



Mesilla de noche XXL
XXL bedside table
73 ME 3 CALT

Mesilla de noche con mesa para comer en la cama en resina fenolica, recomendado para entornos con riesgo bacteriológico medio/alto ex: clínicas; hogares de ancianos, UCC. Mesita con 4 rodesnos, 2 frentes, una puerta con balda y cajón.

Bedside Table with table to eat on the bed, in phenolic resin recommended for environments with medium/high bacteriological risk ex: clinics; nursing homes, UCC. Bedside table with 4 castors, 2 fronts, one door with shelf and drawer.

EXÓTICO XXL



Eléctrico *electric*
73 SF EX EL XXL



Sofá de confort por lo uso de los pacientes y acompañantes. Cuenta con un apoyo de piernas que eleva simultáneamente con la inclinación progresiva del respaldo hasta la posición de tumbado. Estable en todas las posiciones. Brazos fijos. Tapicería en poliuretano de alta densidad con un top de Memory Foam, que da una gran comodidad y óptimo para la prevención de las llagas. La tapicería es forrada en tela vinílica VALÈNCIA de alta resistencia, impermeable y lavable.

Comfort sofa for the use of patients and accompanying persons. Has a leg support that elevates at the same time with the gradual inclination of the back up to the lying position. Stable at all positions. Fixed arms. Padded in high density polyurethane with a Memory Foam top, which gives it a high comfort and optimal for the prevention of bed sores. This upholstery is lined in VALÈNCIA vinyl canvas of high resistance, waterproof and washable.

Dimensiones *Dimensions*

- Ancho asiento *Seat width: 100cm*
- Altura del asiento *Seat height: 50cm*
- Profundidad asiento *Seat depth: 50cm*
- Altura de la espalda *Height of the back: 70 cm*
- Peso máximo del usuario *Maximum user's weight: 250 kg*

Opciones *Options*

- Posibilidad de ruedas *Possibility of wheels*
- Colores a combinar *Colours to combine*

Manual *manual*
73 SF EX MN XXL



CAMILLA DE PACIENTES XXL

XXL PATIENT TROLLEY



73 MC 3 TD



Estructura metálica en acero, pintado en epoxy o equivalente
Dimensiones máximas de camilla con parada 2100x900mm
Dimensiones útiles de la camilla 1900x800mm
Peso máximo del usuario 250kg
Carga admisible de seguridad 305kg
Camilla en HPL radiotransparentes
Estructura bipartida, con sección de espalda articulada con bomba de gas y con mandos de ambos lados
Altura variable aproximadamente entre 500 y 900mm, por cilindros hidráulicos Trendelenberg hidráulico aproximadamente +16° / -16°, accionado por pedal duplo permitiendo la actuación simultánea en ambos cilindros hidráulicos y/o actuación independiente de cada cilindro
Pedales de actuación de los cilindros junto a los pies
Barras con puños para manejo de la camilla en los pies y cabeza
Barandillas laterales pintadas, abatibles y con revestimiento superior en plástico 4 topes en los extremos, con diámetro de 100 mm
4 Ruedas direccionales con 200 mm, con una rueda antiestática
Frenado centralizado total y direccional a 1 rueda
Posibilidad de fijación para soporte de suero en las 4 esquinas

Opciones

Camilla tripartita o cuatripartita articulada con mandos en cada articulación de ambos lados.
Camilla en ABS radiotransparente
Protección de PVC alrededor del perímetro de la camilla
Sistema de cajón para colocación de cassetes para radiología en el respaldo o en toda la longitud de la camilla.
Pedales de actuación de los cilindros hidráulicos de ambos lados
Soporte de suero con 4 ganchos cromados o acero inoxidable
Soporte para botella de oxígeno en cromado o acero inoxidable
Colchón bipartido antiestático 1900x800mm con 80mm de espesor y cinturones para fijación a la estructura



*Steel metallic structure in epoxy painting or equivalent
Maximum dimensions of bed with round corners 2100x900mm
Useful bed dimensions 1900x800mm
Maximum user weight 250kg
Maximum safety load 305kg
Bed in HPL radiotransparent 2 sections bed structure, with articulated back section with gas pump and commands on both sides
Actuation of the back section by gas springs or equivalent, with knob on both sides
Variable height approx. 500/900mm by hydraulic cylinder
Hydraulic trendelenberg and reverse approx. +16° / -16° actuated by double pedal allowing action on both hydraulic cylinders and/or independent action of each cylinder
Cylinders action pedals along the feet
Feet and head bars with handles for transport
Folding painted side rails with plastic coating
Wall protectors 100mm diameter 4 directional wheels with 200mm, one antistatic wheel
Central brakes and 1 wheel directional
Possibility to fix serum support on 4 corners*

Options

*Articulated tripartite or quadripartite bed with commands in each articulations on both sides
Bed in radiotransparent ABS
PVC protection around the perimeter of the bed
Drawer system for placing radiology deck, in the back or at the whole length of the bed.
Actuation pedals of the hydraulic cylinders on both sides.
Serum support with 4 chromated hooks or in stainless steel support for oxygen cylinder-chromated or stainless steel
1900x800mm anti-static bipartite mattress 80mm thick and belts for attachment to the structure*

CAMILLA DE OBSERVACIÓN XXL XXL OBSERVATION STRETCHER



73 MC 3 TD



La marquesa de transporte es producida en tubo de acero pintado en epoxy y lo bastidor articulable en resina fenólica. Colchón en PU de alta densidad y viscoelástico con tapicería en poliuretano bielástico, impermeable a líquidos, permeable al aire, ignífogo (M2 NFP 92 503) (BS 5852 Crib 5), resistente a los hongos y moldes y MRSA, que es resistente a las bacterias multi-resistentes. Su altura es variable por la acción de dos columnas de elevación que también tiene la capacidad de tomar la posición de trendelemburg y anti-trendelemburg. Barandillas plegables lateralmente. Se puede mover por la acción de cuatro ruedas de 150mm con freno central.

The patient transport trolley is produced in steel tube painted in epoxy and the mattress support in phenolic resin. High density Pu and viscoelastic mattress with bielastic polyurethane fabric, impermeable to liquids, air permeable, fire retardant (M2 NFP 92 503) (BS 5852 Crib 5) MRSA, fungi and molds resistant i.e. resistant to multi-resistant bacterias. Its height is variable by the action of two lifting columns which also has the capabillity to take the trendelemburg and anti-trendelemburg position. Folding side rails. Can be moved by the action of four 150mm wheels with central brake.

- anchura width: 100cm
- longitud lenght: 200cm
- peso máximo del usuario maximum user's weight: 250kg
- altura variable (máxima 70cm; mínima 40cm) height variable (max 72cm; min 40cm)
- bastidor articulable en fenólico articulated mattress support
- ruedas de 200mm con freno 200mm wheels with brakes
- soporte de suero serum support

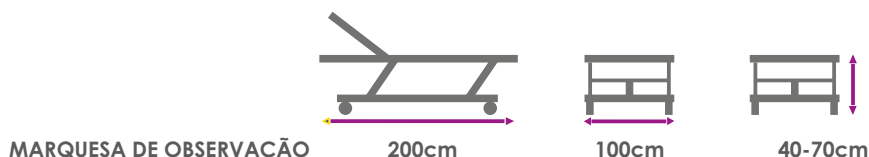

ECLIPSE XXL XXL ECLIPSE



56 GR 3 EL FX 300

- Ideal para hacer la transferencia de la cama a la silla de ruedas.
- Su brazo permite a una persona se plantea desde el suelo
- Puede ser desmontada
- El sistema de pedal de apertura de los pies permite el fácil acceso de una silla de ruedas.
- Recargable, grandes baterías de reserva y sistema de desconectar en una situación de emergencia.
- Peso máximo del usuario:300kg

- Ideal for making the transfer of the bed to the wheelchair
- His arm allows a person to be raised from the ground.
- Can be disassembled.
- The opening feet pedal system allows the easy access of a wheelchair.
- Rechargeable, large batteries of reserve and shutdown system of emergency
- Maximum user weight:300kg



Disponible varios tipos de arneses XXL
Range of XXL slings available

SILLA DE CONSULTÓRIO XXL XXL CONSULT CHAIR



73 CD 3 GM

Silla de consultório xxl xxl consult chair 73 CD 3 GM

Longitud length	100cm
Ancho width	60cm
Altura total overall height	94cm
Longitud de asiento seat length	93cm
Profundidad de asiento seat depth	43cm
Peso máximo del usuario maximum user's weight	250kg

ÍNDICE/ INDEX

SILLA DE RUEDAS PENINSULAR XXL XXL PENINSULAR WHEELCHAIR	2
SILLAS DE BAÑO XXL XXL BATH WHEELCHAIRS	3
CAMA EUPHORIA XXL XXL EUPHORIA BED	4
COLCHONES E COJINES XXL XXL MATTRESSES AND PILLOWS	6
MESITA DE NOCHE XXL XXL BEDSIDE TABLE	7
SILLÓN EXÓTICO XXL XXL EXÓTICO COUCH	8
CAMILLA DE PACIENTES XXL XXL PATIENT TROLLEY	9
CAMILLA DE OBSERVACIÓN XXL XXL OBSERVATION STETCHER	11
ECLIPSE XXL XXL ECLIPSE	12
SILLA DE CONSULTÓRIO XXL XXL CONSULT CHAIR	12

by **ORTHOS**
XXI
e u r o p e a n
i n c l u s i v e s o l u t i o n s

ORTHOSMAIA XXI

C/ Manuel Nuñez nº2 Ofic.9 Pl. 3 | 36203 Vigo | España
Tel: (+34) 886 312 806 | Móvil: (+34) 678 994 993 | E-mail: comercialespana@orthosxxi.com

ORTHOS XXI, Unipessoal Lda.

Rua de Santa Leocádia | 4809-012 Santa Leocádia de Briteiros | Guimarães | Portugal
Phone: (+351) 253 470 276/ 70/ 74 | Mobile: (+351) 936 199 005
E-mail: margarida.silva@orthosxxi.com | sofia.martins@orthosxxi.com
Fax: (+351) 253 470 278
info@orthosxxi.com
www.orthosxxi.com