



Ergoline

Ergonomic & comfort

Calidad, confianza, responsabilidad
Quality, trust, responsibility
Qualität, Vertrauen, Verantwortung
Qualité, confiance, responsabilité



Todo el equipo de **Rocada** le da las gracias por su confianza en nuestros productos.
All **Rocada** Team would like to thank you for your confidence in our products.
Das gesamte **Rocada**-Team möchte sich bei Ihnen für Ihr Vertrauen in unsere Produkte bedanken.
Toute l'équipe **Rocada** vous remercie pour votre confiance en ses produits

Marc Roca
CEO

[ESP] Los productos presentados en este catálogo son reproducciones fotográficas impresas, por lo cual pueden ocasionarse leves variaciones de color en el resultado final. Así pues, este catálogo, aún asemejándose mucho a la realidad, sirve sólo a título orientativo.

Rocada se reserva el derecho de modificar sin previo aviso características, medidas y colores de nuestros productos.

[ENG] The products presented in this catalogue are printed photographic reproductions, so there can be colour variations in the end result. Although its contents bear a close resemblance to the actual products, the catalogue is therefore for guidance purposes only.

Rocada reserves the right to change product specifications, sizes or colors without prior notice.

[DE] Bei den in diesem Katalog abgebildeten Produkten handelt es sich um fotografische Wiedergaben, weshalb es hinsichtlich der Farben zu leichten Abweichungen vom Original kommen kann. Trotz weitestgehender Übereinstimmung mit dem Endprodukt ist dieser Katalog also rein informativ zu verstehen.

Rocada behält sich das Recht vor, Merkmale, Abmessungen und Farben der vorgestellten Produkte ohne Vorankündigung zu verändern.

[FR] Les produits présentés dans ce catalogue sont des reproductions photographiques imprimées ; de ce fait, il peut y avoir de légères variations de couleur dans le produit final. Ce catalogue, bien que très proche de la réalité, ne peut donc servir qu'à titre de référence.

Rocada se réserve le droit de modifier sans avis préalable les caractéristiques, les mesures et les couleurs de ses produits.

Stock permanente • Permanent stock Permanente Lagerhaltung • Stock permanent

[ESP] Rapidez • Eficacia • Stock permanente • Entrega inmediata

En un nuevo mundo globalizado, no puedes permitirte el lujo de malgastar espacio y tiempo, Rocada lo sabe. Una estructura de 20.000m² y un almacén de 5.000m² nos permiten disponer de un stock permanente de productos que asegura una entrega inmediata de 7 días.

[ENG] Speed • Efficiency • Permanent stock • Immediate delivery

In a new globalized world, one cannot permit himself the luxury of wasting space and time. Rocada knows this. A structure of 20,000 m² and a warehouse of 5,000 m² allows us to have the product available for immediate 7-day delivery.

[DE] Schnelligkeit • Wirksamkeit • Permanente Lagerung • Sofortige Lieferung

In einer neuen globalisierten Welt kann man sich den Luxus einer Platz- und Zeitverschwendung nicht erlauben. Rocada ist sich dessen bewusst. Ein Betriebsfläche mit 20.000m² und ein Warenlager von 5.000m² erlaubt es uns, über die Produkte zu verfügen und eine sofortige, 7-tägige Lieferung zu garantieren.

[FR] Rapidité • Efficacité • Stock permanent • Livraison immédiate

À l'heure de la mondialisation, vous ne pouvez plus vous permettre le luxe de mal gérer votre espace et votre temps. Rocada en est conscient. Une structure de 20000 m² et un entrepôt de 5000 m² nous permettent de disposer d'un stock permanent de produits afin de garantir une livraison rapide départ usine dans les 7 jours.



Servicio de montaje Montageservice

[ESP] Ofrecemos la posibilidad de montar cualquier material en cualquier punto del territorio español por un módico precio sin pedido mínimo.

[DE] Wir bieten Ihnen die Möglichkeit, unseren Montageservice in jedem Ort in Deutschland zu einem kleinen Aufpreis in Anspruch zu nehmen, unabhängig von der Höhe des Bestellwerts. Bitte erfragen Sie bei uns vorab die Höhe des Aufpreises.

Proyectos a medida Custom projects Benutzerdefinierte Projekte Projets personnalisés

[ESP] Ofrecemos la posibilidad de realizar proyectos a medida con material estándares de nuestro catálogo o con maderas y acabados especiales. Para más información consultar a Rocada.





[ESP] La certificación alemana GS reconocida a nivel mundial como una de las mejores a nivel europeo, garantiza la seguridad, calidad y continuidad de la fabricación del producto, dando al usuario una máxima seguridad y tranquilidad en su compra.

[ENG] GS German certification is world recognised as one of the best in Europe, a guarantee of safety, quality and product production continuity giving the user maximum security and peace of mind when purchasing.

[DE] Die deutsche GS-Zertifizierung ist weltweit als eine der besten europäischen Zertifizierungen anerkannt. Das GS-Zeichen steht für geprüfte Sicherheit, Qualität und Kontinuität der Warenproduktion und signalisiert dem Endverbraucher ein hohes Maß an Sicherheit.

[FR] La certification allemande GS est reconnue au niveau mondial comme une des meilleures en Europe. Elle garantit la sécurité, la qualité et le suivi de production du produit, elle assure au consommateur une sécurité maximale et la tranquillité par rapport à son achat.



ISO 9001:2015

[ESP] La calidad y fiabilidad de nuestros procesos de producción están avalados por la certificación ISO 9001:2015

[ENG] The quality and reliability of our production processes are guaranteed by ISO 9001:2015 certification.

[DE] Die Qualität und Zuverlässigkeit unserer Produktionsprozesse ist durch ISO 9001:2015

[FR] La qualité et la fiabilité de nos processus de production sont garanties par la certification ISO 9001:2015



ISO 14001:2015

[ESP] Respetar y proteger el medioambiente es prioritario en nuestros procesos productivos. El uso de productos reciclados y la utilización razonable de los recursos son prioridades

[ENG] Respect for and protection of the environment are priorities in our production processes. The use of recycled products and the reasonable use of resources are unbending priorities.

[DE] Der Umweltschutz gehört im Rahmen unserer Produktionsprozesse zu den zentralen Anliegen. Der Einsatz von Recyclingmaterialien und die vernünftige Nutzung von natürlichen Ressourcen steht für uns an erster Stelle.

[FR] Respecter et protéger l'environnement est une priorité pour nos processus de production. L'utilisation de matières recyclées et l'utilisation raisonnable des ressources sont des priorités essentielles.



SOFT SEATING

[ESP] BE SOFT es una colección de 'soft seating' formado por diferentes conceptos de funcionalidad. Individuales, dobles y modulares. Los diferentes módulos permiten satisfacer a las nuevas necesidades de reunión, comunicación y relación entre personas siguiendo las nuevas tendencias de creación de espacios donde la persona pasa a ser el núcleo. El programa ha sido concebido bajo un concepto de configuración total, con una gran capacidad de personalización que proporciona al usuario opciones de uso variadas. Materiales como el acero, espumas, tapizados, maderas, ... se unen para formar módulos de utilización libre dando a cualquier ambiente un aire fresco y diferenciador.

[ENG] BE SOFT. It is a collection of 'soft seating' formed by different concepts of functionality. Individual, double and modular, the different modules enables the new needs of having a meeting, communication and relationship between people following the new trends of creation of spaces where the person becomes the focal point. The program has been conceived under a concept of total configuration, with a great capacity of personalization that provides to the user options of varied use. Materials such as steel, foam, upholstery, wood, ... come together to form modules of free use giving any environment a fresh unique touch

[DE] BE SOFT ist eine Kollektion für „soft seating“, die verschiedene Konzepte in Verbindung mit Funktionalität und Benutzerfreundlichkeit umfasst. Individuell, doppelt und modular. Durch die verschiedenen Module können die zeitgemäßen Anforderungen in Bezug auf Versammlungen, Kommunikation und das zwischenmenschliche Verhältnis erfüllt werden, dies unter Berücksichtigung der neuen Trends zur Schaffung von Räumen, bei denen der Mensch im Mittelpunkt steht. Das Programm ist unter dem Konzept der Komplett-Konfiguration entwickelt worden und umfasst umfangreiche Möglichkeiten der persönlichen Gestaltung, die dem Benutzer vielfältige Anwendungsmöglichkeiten bieten. Werkstoffe wie Stahl, Schaumstoff, Polsterungen, Holz usw. werden kombiniert, um Module zur freien Anwendung zu bilden, die jeder Umgebung einen Hauch von Frische und Originalität verleihen.

[FR] BE SOFT est une collection de « soft seating » composée de différents concepts de fonctionnalité. Individuels, doubles et modulaires. Les différents modules satisfont aux nouveaux besoins de réunion, communication et relation entre les personnes, en surfant sur les nouvelles tendances de création d'espaces qui placent la personne au centre du projet. Le programme a été conçu selon un concept de configuration totale, avec une grande capacité de personnalisation qui offre à l'utilisateur des options d'utilisation diverses. Des matériaux comme l'acier, les mousses, la tapisserie, le bois, etc. entrent en communion pour former des modules d'utilisation libre conférant à tout environnement une touche fraîche et différente.









SOFT SEATING

[ESP] BE SOFT es un programa que dispone de diferentes artículos pensados para dar solución a todo tipo de necesidades. Los módulos de 1 y 2 asientos combinados con la pequeña mesa de trabajo, permiten conseguir espacios de ambientes distendidos y agradables, donde la comunicación fluye sin obstáculos. Es la creación de espacios más adaptados a las nuevas tendencias de relación humana.

[ENG] BE SOFT is a program that has different articles designed to solve all kinds of needs. The idea of 1 and 2 seats combined with the small work table allows to achieve spaces of relaxed, pleasant environments where communication flows. The creation of spaces to adapt to the new trends of human relationship.

[DE] BE SOFT ist ein Programm, das über verschiedene Artikel verfügt, die Lösungen für alle erdenklichen Anforderungen bieten. Die Module mit 1 und 2 Sitzen, kombiniert mit einem kleinen Arbeitstisch, ermöglichen die Erschaffung von Räumen mit einer entspannten und angenehmen Atmosphäre, in denen die Kommunikation ungehindert fließen kann. Es entstehen Räume, die besser an die neuen Trends in Sachen zwischenmenschlicher Beziehung angepasst sind.

[FR] BE SOFT est un programme qui dispose de différents articles pensés pour répondre à tous les besoins. Les modules de 1 et 2 places associés à la petite table de travail donnent naissance à des espaces de détente agréables où la communication circule sans obstacle. C'est la création d'espaces plus adaptés aux nouvelles tendances de relation humaine.



NEW



Montaje bajo pedido
Assembly on request

Acabados panel trasero
Back panel finishes

- 1

Gris / Grey
Grau / Gris
- 2*

Rojo / Red
Rot / Rouge
- 3*

Azul / Blue
Blau / Bleu
- 4*

Negro / Black
Schwarz / Noir
- 5*

Naranja
Orange
- 6*

Verde / Green
Grün / Vert

*Bajo pedido / *On request / *Auf Anforderung / *Sur demande

Acabados mesa
Table finishes

- 4

Roble / Oak
Eiche / Chêne

Acabados módulos
Module finishes

- 4

Negro / Black
Schwarz / Noir

Medidas / Sizes (cm)

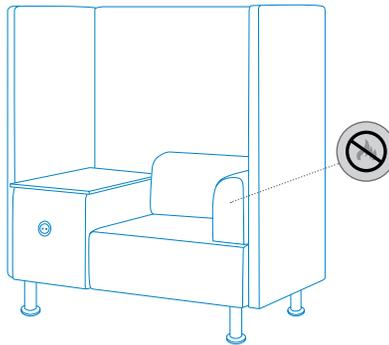
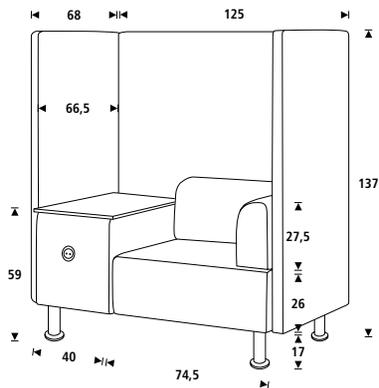

Sistema de enchufe / Plug system included

Ref.	cm (embalaje / packaging)	kg / m ³ (embalaje / packaging)
1806-4-1	139x120x80	100,00 kg / 1,234 m ³

SOFT SEATING

[ESP] BE SOFT es un programa que dispone de diferentes artículos pensados para dar solución a todo tipo de necesidades. Los módulos de 1 y 2 asientos combinados con la pequeña mesa de trabajo, permiten conseguir espacios de ambientes distendidos y agradables, donde la comunicación fluye sin obstáculos. Es la creación de espacios más adaptados a las nuevas tendencias de relación humana.

[ENG] BE SOFT is a program that has different articles designed to solve all kinds of needs. The idea of 1 and 2 seats combined with the small work table allows to achieve spaces of relaxed, pleasant environments where communication flows. The creation of spaces to adapt to the new trends of human relationship.

[DE] BE SOFT ist ein Programm, das über verschiedene Artikel verfügt, die Lösungen für alle erdenklichen Anforderungen bieten. Die Module mit 1 und 2 Sitzen, kombiniert mit einem kleinen Arbeitstisch, ermöglichen die Erschaffung von Räumen mit einer entspannten und angenehmen Atmosphäre, in denen die Kommunikation ungehindert fließen kann. Es entstehen Räume, die besser an die neuen Trends in Sachen zwischenmenschlicher Beziehung angepasst sind.

[FR] BE SOFT est un programme qui dispose de différents articles pensés pour répondre à tous les besoins. Les modules de 1 et 2 places associés à la petite table de travail donnent naissance à des espaces de détente agréables où la communication circule sans obstacle. C'est la création d'espaces plus adaptés aux nouvelles tendances de relation humaine.

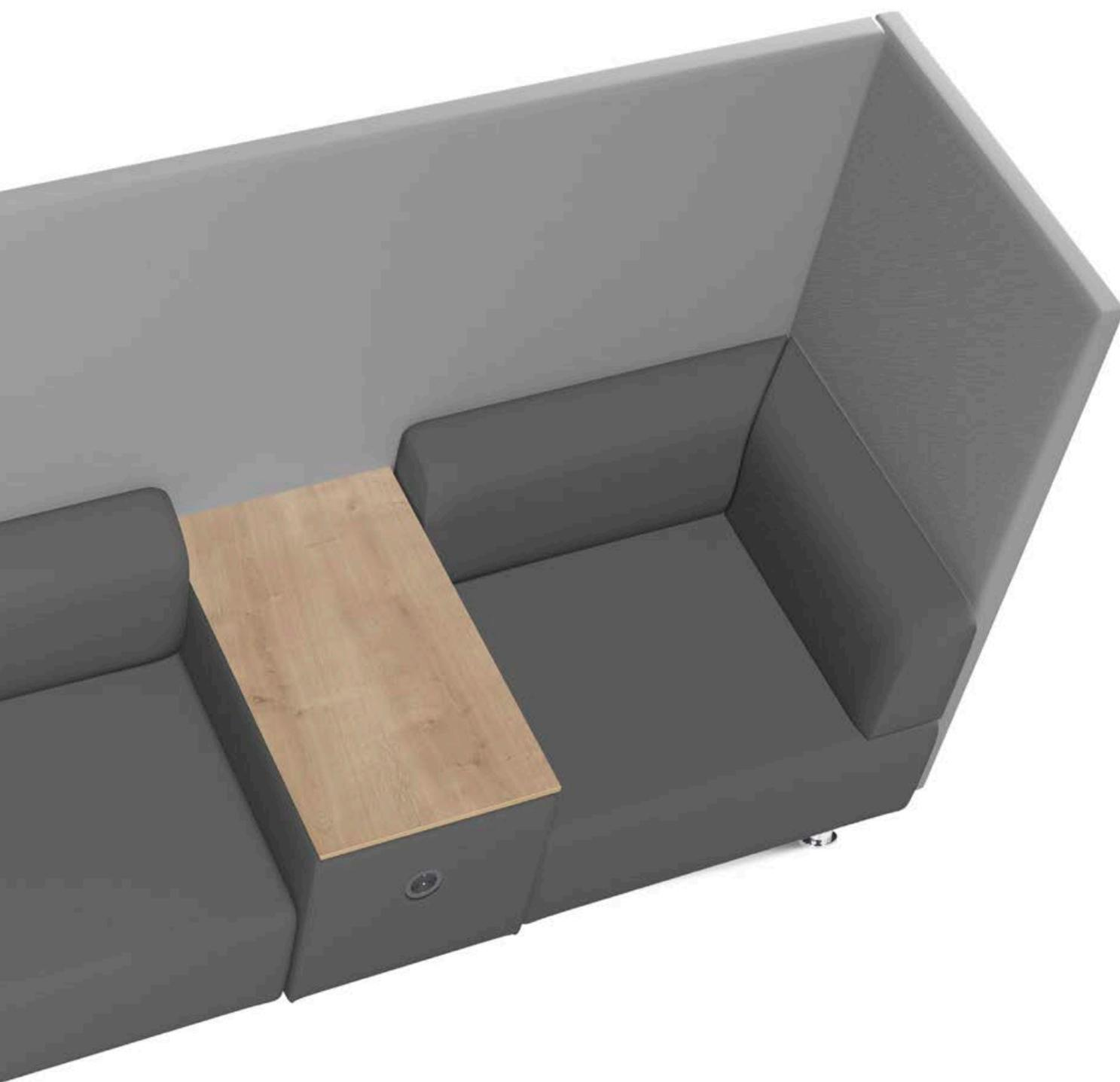

NEW



Montaje bajo pedido
Assembly on request

Acabados panel trasero
Back panel finishes

- 1

Gris / Grey
Grau / Gris
- 2*

Rojo / Red
Rot / Rouge
- 3*

Azul / Blue
Blau / Bleu
- 4*

Negro / Black
Schwarz / Noir
- 5*

Naranja
Orange
- 6*

Verde / Green
Grün / Vert

*Bajo pedido / *On request / *Auf Anforderung / *Sur demande

Acabados mesa
Table finishes

- 4

Roble / Oak
Eiche / Chêne

Acabados módulos
Module finishes

- 4

Negro / Black
Schwarz / Noir

Medidas / Sizes (cm)

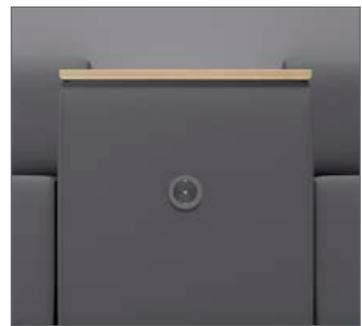
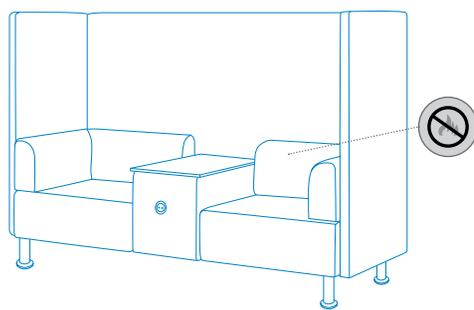
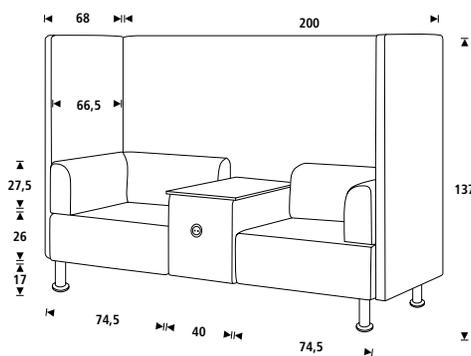

Sistema de enchufe / Plug system included

Ref.	cm (embalaje / packaging)	kg / m ³ (embalaje / packaging)
1805-4-1	205x140x70	160,00 kg / 2,105 m ³

SOFT SEATING

[ESP] Este módulo individual del programa **BE SOFT** permite combinar el descanso y el trabajo en todos sus estados. El contraste entre su privacidad y su personalidad, permite diseñar espacios polivalentes donde la persona es la protagonista

[ENG] This individual module of the **BE SOFT** program allows you to combine rest and work. The contrast between the privacy and personality allows to design multipurpose spaces where the person is the protagonist.

[DE] Mit diesem Einzelmodul des Programms **BE SOFT** können Erholung und Arbeit in jeglicher Form kombiniert werden. Der Kontrast von Privatsphäre und Persönlichkeit erlaubt den Entwurf von vielseitigen Räumen, bei denen der Mensch im Mittelpunkt steht.

[FR] Ce module individuel du programme **BE SOFT** permet d'associer repos et travail en tout point. Le contraste entre la confidentialité et la personnalité permet de concevoir des espaces polyvalents au cœur desquels se trouve la personne.



NEW

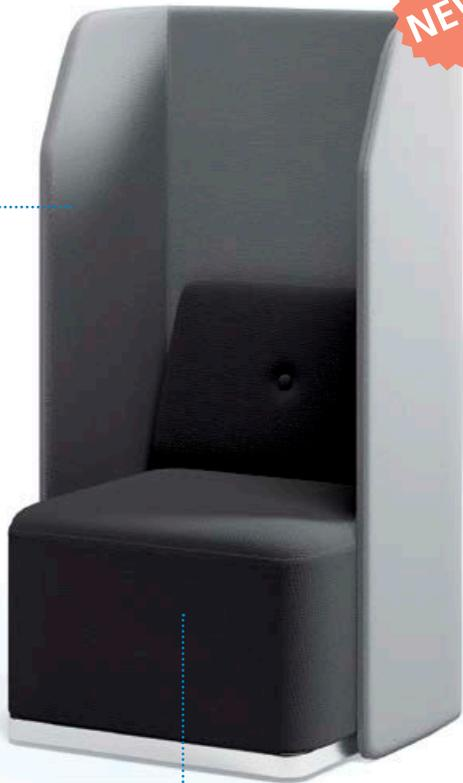

Acabados panel trasero
Back panel finishes

- 1

Gris / Grey
Grau / Gris
- 2*

Rojo / Red
Rot / Rouge
- 3*

Azul / Blue
Blau / Bleu
- 4*

Negro / Black
Schwarz / Noir
- 5*

Naranja
Orange
- 6*

Verde / Green
Grün / Vert

*Bajo pedido / *On request / *Auf Anforderung / *Sur demande

Acabados módulos
Module finishes

- 4

Negro / Black
Schwarz / Noir

Medidas / Sizes (cm)

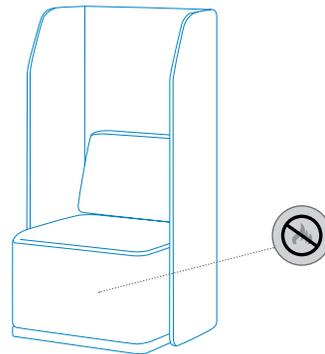
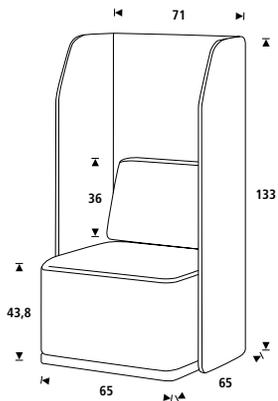

Ref.	cm (embalaje / packaging)	kg / m ³ (embalaje / packaging)
1804-4-1	135x74x69	25,00 kg / 0,689 m ³

TABURETES

STOOLS • HOCKER • TABOURETS

[ESP] Nuevo taburete regulable en altura con diseño innovador acorde con los nuevos momentos del mercado. Complemento perfecto para áreas de descanso, zonas mixtas de trabajo y espacios polivalentes, donde el confort y la estética se dan la mano. Su regulación en altura y su balanceo permiten un uso adecuado para cada momento

[ENG] New height adjustable stool with an innovative design in accordance with the latest market. Perfect complement for rest areas, mixed work areas and multipurpose spaces, where comfort and aesthetics come together. Its regulation in height and its rolling allows an adequate use for each moment.

[DE] Neuer höhenverstellbarer Hocker mit innovativem Design, der den neuen Marktanforderungen gerecht wird. Die ideale Ergänzung für Ruhezonen, gemischte Arbeitsbereiche und Mehrzweckräume, in denen sich Komfort und Ästhetik die Hand reichen. Die Höhenverstellung und die Schwingbewegung ermöglichen einen jederzeit angemessenen Einsatz.

[FR] Nouveau tabouret réglable en hauteur avec un design innovant parfaitement adapté aux nouveaux moments du marché. C'est l'accessoire idéal pour les zones de repos, les zones mixtes de travail et les espaces polyvalents, où le confort et l'esthétique vont main dans la main. Son réglage en hauteur et son balancier lui confèrent une utilisation adaptée à tout moment.





Base basculante
Tilting base

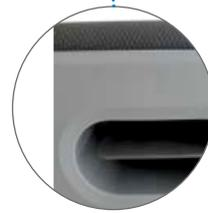

Manecilla / Handle



Acabados estructura
Structure finishes

1

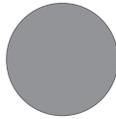

Gris / Grey
Grau / Gris

Acabados asiento
Seat finishes

4



Negro / Black
Schwarz / Noir

Medidas / Sizes (cm)

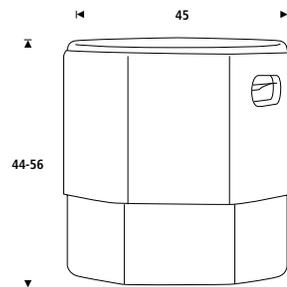

Asiento tapizado en tela ignífuga.
Seat upholstered in fire-resistant fabric.

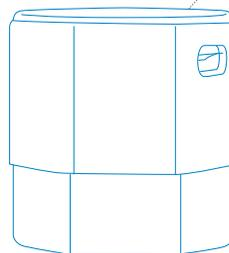

Ref.	cm (embalaje / packaging)	kg / m ³ (embalaje / packaging)
1828-4-1	46x46x45	11,30 kg / 0,095 m ³

SILLONES RECEPCIÓN

WAITING ROOMS SOFA • WARTEZIMMER SOFA • CANAPÉ POUR SALLES D'ATTENTE

[ESP] Sofá de 1, 2 y 3 plazas tapizado en simil piel sobre una estructura robusta. Pies cromados. Ideal para salas de espera, recibidores...

[ENG] 1, 2 and 3 person sofa upholstered in imitation leather over a robust structure. Chromed feet. Ideal for waiting rooms, receptions...

[DE] Sofa (1-, 2- oder 3-Sitzer) mit hochwertigem Bezug aus Lederimitat. Verchromte Fußteile. Ideal für die Einrichtung von Wartezimmern, Empfangs- und Kombizonen. Teilmontiert.

[FR] Canapé 1, 2 et 3 places tapissé en simil cuir sur structure très robuste. Pieds chromés. Idéal pour les salles d'attente, halls d'accueil,...





Medidas / Sizes (cm)

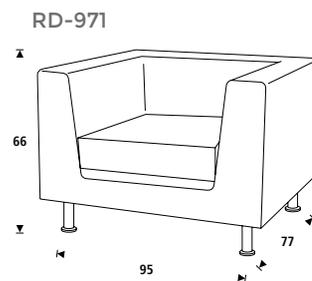
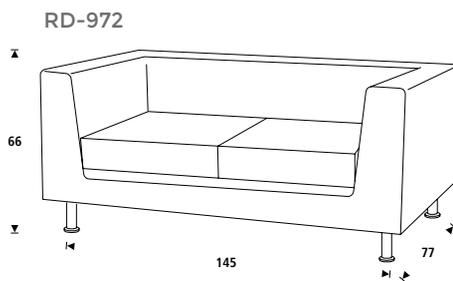
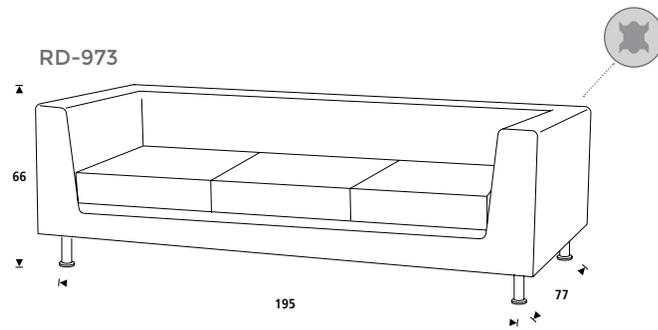

Ref.	cm (embalaje / packaging)	kg / m ³ (embalaje / packaging)
RD-971 (95 cm)	95x91x60	29,60 kg / 0,445 m ³
RD-972 (145 cm)	150x78x60	40 kg / 0,710 m ³
RD-973 (195 cm)	195x78x60	50 kg / 0,940 m ³

SILLAS DIRECCIÓN

DIRECTOR'S CHAIRS • DIREKTIONSSTÜHLE • FAUTEUILS DE DIRECTION

[ESP] Silla de dirección con el asiento y respaldo tapizado en simil piel sobre interior de espuma inyectada. Base de aluminio inyectado y robusto mecanismo sincro profesional. Estructura de unión metálica. Brazos y reposacabezas de serie. Admite ruedas de parquet RD-917. Fácil montaje.

[ENG] Manager chair upholstered in PU leather with deep cushioned seat and back. Aluminium 5 star base and quality castors, asynchro mechanism fully adjustable for comfort. Polished chrome finish and integral cushioned arms. Includes headrest Compatible with RD-917 parquet castors. Easy assembly.

[DE] Ergonomisch geformter Chefsessel. Sitzfläche und Rückenlehne sind mit einem atmungsaktiven Formschaum ausgepolstert. Bezug aus PU - Ledernachbildung. Verchromte Armlehne mit Armauflage. Synchronmechanik mit stufenloser Einstellung des Rückenlehnen-Gegendrucks. Fußgestell aus Aluminium. Kopfstütze und Armlehnen serienmäßig.

[FR] Chaise de direction, siège et dos en simil cuir sur coussins de mousse. Pied en aluminium avec mécanisme de réglage robuste. Accoudoirs et appuie-têtes de série. Possibilité d'installer des roues spéciales pour parquet RD-917. Montage facile.



UNE EN 1335-1 / -2 / -3





Medidas / Sizes (cm)

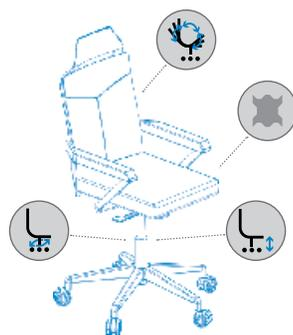
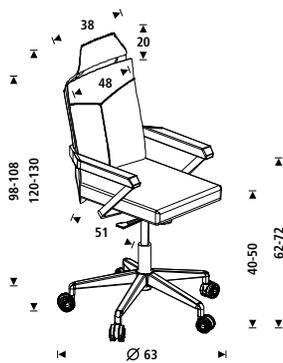

RD-917
Opcional / Optional



Ruedas parquet Ø60mm
Laminated floor castors Ø60mm
Hartbodenrollen Ø60mm
Roulettes parquet Ø60mm

Ref.	cm (embalaje / packaging)	kg / m ³ (embalaje / packaging)
RD-998V15	83x65x60	26,25 Kg / 0,324 m ³
RD-917 (Opcional / Optional)	11x6,3x25	0,5 kg / 0,001 m ³

SILLAS DIRECCIÓN

DIRECTOR'S CHAIRS • DIREKTIONSSTÜHLE • FAUTEUILS DE DIRECTION

[ESP] Silla con ruedas tapizada en simil piel con base metálica cromada y sistema basculante. Incluye brazos metálicos cromados y ruedas de parquet.

[ENG] Wheeled chair upholstered in imitation leather with a chromed metal base and swivelling system mechanism. Includes chromed metal arms and castors.

[DE] Bürostuhl mit einem Bezug aus hochwertigem Lederimitat, Gestell aus verchromtem Metall. Wippmechanik. Hohe Rückenlehne mit Nackenstütze. Armlehnen aus Metall und Hartbodenrollen im Lieferumfang enthalten.

[FR] Chaise à roulettes tapissée en simili cuir sur base métallique chromée et système basculant. Comprend accoudoirs métalliques chromés et roulettes parquet.





Máx
100 kg



Medidas / Sizes (cm)

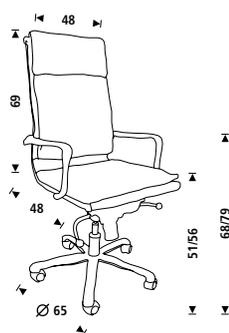

Ref.	cm (embalaje / packaging)	kg / m ³ (embalaje / packaging)
RD-986	92x62x48	17,20 kg / 0,274 m ³

SILLAS DIRECCIÓN

DIRECTOR'S CHAIRS • DIREKTIONSSTÜHLE • FAUTEUILS DE DIRECTION

[ESP] Silla con ruedas tapizada en simil piel con base metálica cromada y sistema fijo y basculante. Incluye brazos metálicos y ruedas de parquet.

[ENG] Wheeled chair upholstered in imitation leather with a chromed metal base and swivelling system mechanism. Includes metal arms and castors.

[DE] Bürodrehstuhl mit einem Bezug aus hochwertigem Lederimitat, Gestell aus verchromtem Metall. Wippmechanik. Metallarmlehnen mit Auflagefläche und Hartbodenrollen im Lieferumfang enthalten.

[FR] Chaise à roulettes tapissée en simili cuir sur base métallique chromée et système basculant. Comprend accoudoirs métalliques et roulettes parquet.





Máx
100 kg



Medidas / Sizes (cm)

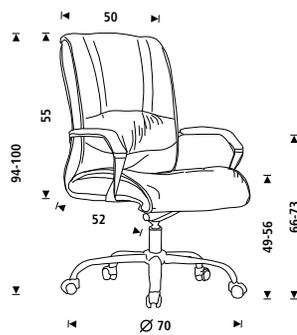

Ref.	cm (embalaje / packaging)	kg / m ³ (embalaje / packaging)
RD-988	78x63x54	19,20 kg / 0,265 m ³

SILLA CONFIDENTE

VISITOR'S CHAIR • BESUCHERSTUHL • CHAISE DE VISITEUR

[ESP] Silla confidente de dirección tapizada en simil piel con base metálica cromada con sistema antivuelco. Brazos metálicos cromados de serie. Viene montada.

[ENG] Visitors or boardroom chair in PU leather with generous size padded seat and back. Cantilever chromed base with anti-topple system. Features padded armrests for superior arm support. Comes assembled.

[DE] Bequemer Besucherstuhl mit einer Polsterung aus atmungsaktivem Formschaum und einem Bezug aus PU - Ledernachbildung Freischwinger - Chromgestell mit integrierter Armauflage.

[FR] Chaise visiteur de direction en simili cuir et base métallique chromée. Bras métalliques chromés de série. Livré monté.



UNE EN 13761
UNE EN 1022



Medidas / Sizes (cm)

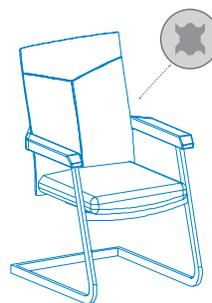
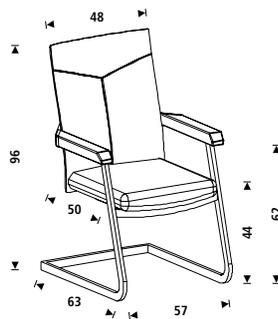

Ref.	cm (embalaje / packaging)	kg / m ³ (embalaje / packaging)
RD-990	70x60x95	20 kg / 0,399 m ³

SILLA CONFIDENTE

VISITOR'S CHAIR • BESUCHERSTUHL • CHAISE DE VISITEUR

[ESP] Silla confidente tapizada en símil piel con estructura metálica cromada. Brazos metálicos cromados de serie.

[ENG] Visitor's chair upholstered in imitation leather with chromed metal base. Chromed metal arms are included.

[DE] Graziler Besucher- und Konferenzstuhl mit Freischwinger-Effekt. Sitzfläche und Rückenlehne mit hochwertiger Ledernachbildung bezogen. Verchromtes Stuhlgestell mit integrierten Armlehnen.

[FR] Chaise visiteur tapissée en simili cuir sur base métallique chromée. Accoudoirs métalliques chromés de série.



UNE EN 13761
UNE EN 1022





Medidas / Sizes (cm)

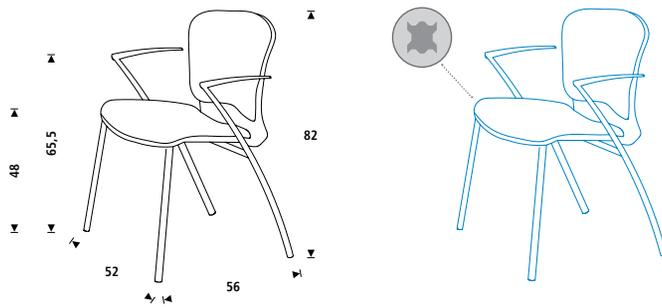

Ref.	cm (embalaje / packaging)	kg / m ³ (embalaje / packaging)
RD-966 (2u.)	59x56x72	18 kg / 0,238 m ³

SILLA CONFIDENTE

VISITOR'S CHAIR • BESUCHERSTUHL • CHAISE DE VISITEUR

[ESP] Silla confidente tapizada en símil piel con base metálica cromada. Brazos metálicos cromados de serie.

[ENG] Visitor's chair upholstered in imitation leather with chromed metal base. Chromed metal arms are included.

[DE] Bequem ausgepolsterter Design-Freischwinger mit Bezug aus hochwertigem Lederimitat. Gestell und Armlehnen verchromt.

[FR] Chaise visiteur tapissée en simili cuir sur base métallique chromée. Accoudoirs métalliques chromés de série.





Medidas / Sizes (cm)

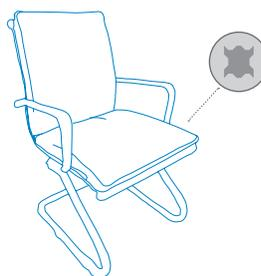
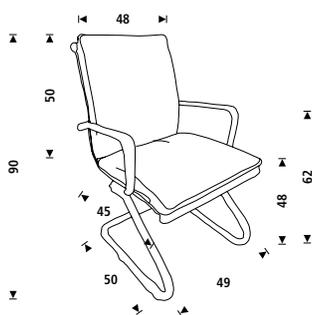

Ref.	cm (embalaje / packaging)	kg / m ³ (embalaje / packaging)
RD-985	79x53x41	11,60 kg / 0,172 m ³

SILLA CONFIDENTE

VISITOR'S CHAIR • BESUCHERSTUHL • CHAISE DE VISITEUR

[ESP] Silla confidente tapizada en símil piel con base tubular metálica y cromada. Brazos incorporados.

[ENG] Visitor's chair upholstered in imitation leather with chromed tubing metal base. Arms incorporated.

[DE] Besucherstuhl, kompakter Freischwinger mit Bezug aus hochwertigem Lederimitat. Verchromtes Stahlrohrgestell mit Armauflagen.

[FR] Chaise visiteur tapissée en simili cuir sur base en tube métallique et chromée. Accoudoirs inclus.





Medidas / Sizes (cm)

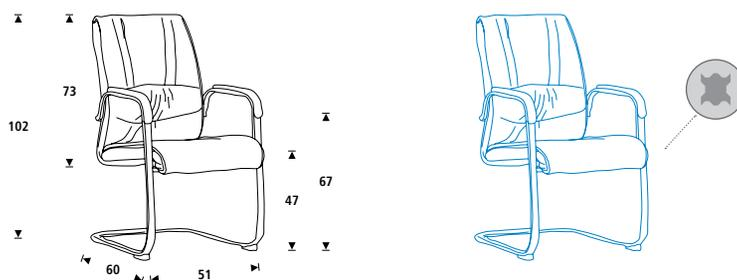

Ref.	cm (embalaje / packaging)	kg / m ³ (embalaje / packaging)
RD-987	80x63x61	16,75 kg / 0,307 m ³

SILLAS OFICINA

OFFICE CHAIRS • BÜROSTÜHLE • SIÈGES DE BUREAU

[ESP] Silla de oficina profesional tapizada en tela ignífuga sobre interior de espuma inyectada, base de aluminio y robusto mecanismo sincro profesional para un uso diario. Brazos regulables de serie. Admite ruedas de parquet RD-917. Fácil montaje.

[ENG] Professional office chair with flame retardant fabric deep cushioned seat and back. Aluminium base and synchro mechanism for daily use. Includes adjustable armrest. Standard adjustable arms. Compatible with RD-917 parquet castors. Easy assembly.

[DE] Ein attraktiver und komfortabler Drehstuhl für den täglichen Büroalltag. Aluminiumgestell mit großen, stabilen Laufrollen. Ergonomisch geformte, hohe Rückenlehne. Feuerhemmender Stoffbezug in 3 Farben. Synchronmechanik. Stufenlose Höhenverstellung mittels bauartgeprüfter Gasdruckfeder. Verstellbare Armlehnen serienmäßig. Leichte Montage

[FR] Chaise de bureau professionnelle tapissée en toile ignifuge, base en aluminium et mécanisme synchro professionnel très robuste pour usage quotidien. Accoudoirs réglables de série. Possibilité d'installer des roues spéciales pour parquet RD-917. Facile à monter.



UNE EN 1335-1 / -2 / -3





Máx
125 kg



*Bajo pedido / *On request / *Auf Anforderung / *Sur demande

Medidas / Sizes (cm)

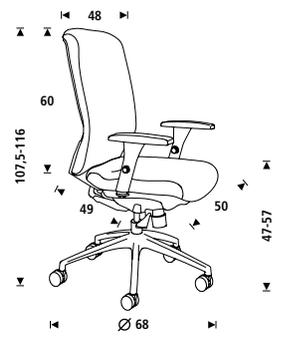

RD-917
Opcional / Optional



Ruedas parquet Ø60mm
Laminated floor castors Ø60mm
Hartbodenrollen Ø60mm
Roulettes parquet Ø60mm



Brazos regulables en altura
Height adjustable armrest

Ref.	cm (embalaje / packaging)	kg / m ³ (embalaje / packaging)
RD-944V15-1*	77x67x42	23,6 kg / 0,217 m ³
RD-944V15-2*	77x67x42	23,6 kg / 0,217 m ³
RD-944V15-3	77x67x42	23,6 kg / 0,217 m ³
RD-944V15-4	77x67x42	23,6 kg / 0,217 m ³
RD-944V15-5*	77x67x42	23,6 kg / 0,217 m ³
RD-944V15-6*	77x67x42	23,6 kg / 0,217 m ³
RD-917 (Opcional / Optional)	11x6,3x25	0,5 kg / 0,001 m ³

SILLAS OFICINA

OFFICE CHAIRS • BÜROSTÜHLE • SIÈGES DE BUREAU

[ESP] Silla de oficina profesional con el asiento tapizado en tela ignífuga sobre interior de espuma inyectada y el respaldo de malla negra regulable en altura tapizado sobre estructura inyectada en polímero técnico, base de polímero inyectado y robusto mecanismo sincro. Regulación lumbar y asiento desplazable. Brazos regulables de serie. Admite ruedas de parquet RD-917. Fácil montaje.

[ENG] Professional office chair with the seat upholstered in fire-resistant fabric over an interior of injected foam and an upholstered adjustable-height backrest on a structure of injected technical polymer, base of injected aluminium with robust synchro mechanism. Sliding seat and lumbar adjustment. Standard adjustable arms. Admits RD-917 parquet wheels. Easy assembly.

[DE] Komfortabler Drehstuhl mit Polsterschaum-Sitz für den Büroalltag. Feuerabweisender Stoffbezug. Höhenverstellbare Rückenlehne aus Kunststoffspritzguss mit Geflechtbezug. Solide Synchronmechanik und Fußgestell aus Aluminiumdruckguss. Sitztiefenverstellung. Verstellbare Armlehnen serienmäßig. Kann mit Hartbodenrollen (RD 917) ausgestattet werden.

[FR] Chaise de bureau professionnelle avec assise tapissée en toile ignifugée sur coussin en mousse injectée et dossier tapissé réglable en hauteur sur structure injectée en polymère technique, base en aluminium injecté et robuste mécanisme synchro. Réglage lombaire. Accoudoirs réglables de série. Possibilité d'installer des roues spéciales pour parquet RD-917. Facile à monter.



NEW

RD-937HR
Reposabrazos (opcional)
Headrest (optional)
30 x 19 cm



Respaldo regulable
Adjustable backrest



NEW

Asiento desplazable
Sliding seat



**CERTIFICADA
CERTIFIED**

UNE EN 1335-1 / -2 / -3



*Bajo pedido / *On request / *Auf Anforderung / *Sur demande

Medidas / Sizes (cm)

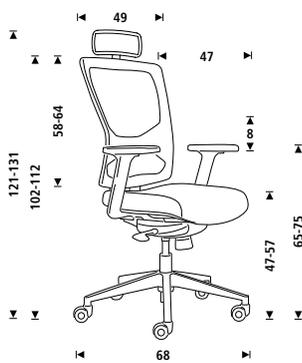

RD-917
Opcional / Optional



Ruedas parquet Ø60mm
Laminated floor castors Ø60mm
Hartbodenrollen Ø60mm
Roulettes parquet Ø60mm



Regulación lumbar
Lumbar height
adjustable system



Brazos regulables en altura
Height adjustable armrest

Ref.	cm (embalaje / packaging)	kg / m ³ (embalaje / packaging)
RD-937V19-1*	67x67x47	21 kg / 0,211 m ³
RD-937V19-2*	67x67x47	21 kg / 0,211 m ³
RD-937V19-3	67x67x47	21 kg / 0,211 m ³
RD-937V19-4	67x67x47	21 kg / 0,211 m ³
RD-937V19-5*	67x67x47	21 kg / 0,211 m ³
RD-937V19-6*	67x67x47	21 kg / 0,211 m ³
RD-937HR reposacabezas - headrest	35x25x12	1,35 kg / 0,010 m ³
RD-917 (Opcional / Optional)	11x6,3x25	0,5 kg / 0,001 m ³

SILLAS OFICINA

OFFICE CHAIRS • BÜROSTÜHLE • SIÈGES DE BUREAU

[ESP] Silla oficina tapizada en tela ignífuga sobre interior de espuma inyectada, base de polímero técnico y robusto mecanismo sincro basculante para un uso diario. Brazos regulables de serie. Admite ruedas de parquet RD-917. Fácil montaje.

[ENG] Office chair with flame retardant fabric deep cushioned seat and back. Polymer base and synchro mechanism for daily use. Standard adjustable arms. Compatible with RD-917 parquet castors. Easy assembly.

[DE] Komfort- Bürostuhl mit Muldensitz und feuerbeständigem Stoffbezug. Synchronmechanik. Kunststofffuß. Stufenlose Höherverstellung mittels bauartgeprüfter Gasdruckfeder. Verstellbare Armlehnen serienmäßig. Leichte Montage.

[FR] Chaise de bureau ergonomique, toile ignifugé et mécanisme synchrone-basculant. Rembourrage mousse et roulettes. Pour usage quotidien. Accoudoirs réglables de série. Facile à monter.



UNE EN 1335-1 / -2 / -3



*Bajo pedido / *On request / *Auf Anforderung / *Sur demande

Medidas / Sizes (cm)

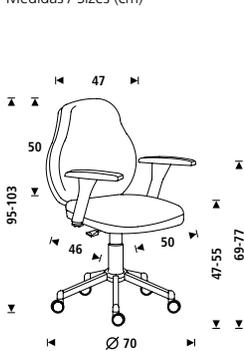

RD-917
Opcional / Optional



Ruedas parquet Ø60mm
Laminated floor castors Ø60mm
Hartbodenrollen Ø60mm
Roulettes parquet Ø60mm



Brazos regulables en altura
Height adjustable armrest

Ref.	cm (embalaje / packaging)	kg / m ³ (embalaje / packaging)
● RD-939V19-1*	66x63x33	18,10 kg / 0,137 m ³
● RD-939V19-2*	66x63x33	18,10 kg / 0,137 m ³
● RD-939V19-3	66x63x33	18,10 kg / 0,137 m ³
● RD-939V19-4	66x63x33	18,10 kg / 0,137 m ³
● RD-939V19-5*	66x63x33	18,10 kg / 0,137 m ³
● RD-939V19-6*	66x63x33	18,10 kg / 0,137 m ³
RD-917 (Opcional / Optional)	11x6,3x25	0,5 kg / 0,001 m ³

SILLAS OFICINA

OFFICE CHAIRS • BÜROSTÜHLE • SIÈGES DE BUREAU

[ESP] Silla de oficina operativa con asiento tapizado con tela ignifuga sobre ignifuga sobre interior de espuma inyectada, respaldo inyectado en polímero técnico tapizado con malla. Base en polímero técnico y robusto mecanismo sincro - basculante para un uso diario. Regulación lumbar. Brazos regulables de serie. Admite ruedas de parquet RD-917. Fácil montaje.

[ENG] Operative office chair of fire-resistant fabric over an interior of injected foam, mesh backrest in injected technical polymer. Technical polymer base and robust swivelling mechanism for daily use. Lumbar adjustment. Standard adjustable arms. Admits RD-917 parquet wheels. Easy assembly.

[DE] Bürostuhl für den täglichen Gebrauch. Polsterschaum-Sitzfläche, mit feuerhemmendem Stoffbezug. Rückenlehne aus Kunststoffspritzguss mit Netzbezug. Mit Wippmechanik und Kunststofffußgestell. Verstellbare Armlehnen serienmäßig. Kann mit Hartbodenrollen (RD-917) ausgestattet werden.

[FR] Chaise de bureau opérationnelle en toile ignifugée sur coussin en mousse injectée, dossier injecté en polymère technique tapissé en maille. Base polymère technique et robuste mécanisme basculant pour utilisation quotidienne. Réglage lombaire. Accoudoirs réglables de série. Possibilité d'installer des roues spéciales pour parquet RD-917. Montage facile.





*Bajo pedido / *On request / *Auf Anforderung / *Sur demande

Medidas / Sizes (cm)

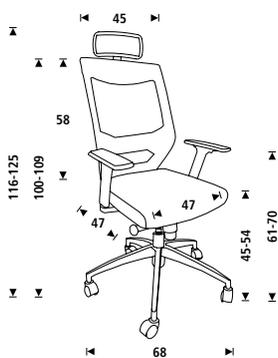

RD-917
Opcional / Optional



Ruedas parquet Ø60mm
Laminated floor castors Ø60mm
Hartbodenrollen Ø60mm
Roulettes parquet Ø60mm



Regulación lumbar
Lumbar height adjustable system



Brazos regulables en altura
Height adjustable armrest

Ref.	cm (embalaje / packaging)	kg / m ³ (embalaje / packaging)
● RD-908W-1*	68x63x29	17,50 kg / 0,124 m ³
● RD-908W-2*	68x63x29	17,50 kg / 0,124 m ³
● RD-908W-3	68x63x29	17,50 kg / 0,124 m ³
● RD-908W-4	68x63x29	17,50 kg / 0,124 m ³
● RD-908W-5*	68x63x29	17,50 kg / 0,124 m ³
● RD-908W-6*	66x63x33	17,50 kg / 0,124 m ³
RD-908WHR reposacabezas opcional / headrest optional	35x25x12	1,35 kg / 0,010 m ³
RD-917 (Opcional / Optional)	11x6,3x25	0,5 kg / 0,001 m ³

SILLAS OFICINA

OFFICE CHAIRS • BÜROSTÜHLE • SIÈGES DE BUREAU

[ESP] Silla de oficina operativa con asiento tapizado con tela ignífuga sobre interior de espuma inyectada, respaldo inyectado en polímero técnico tapizado con malla. Base en polímero técnico y robusto mecanismo sincro - basculante para un uso diario. Regulación lumbar. Brazos regulables de serie. Admite ruedas de parquet RD-917. Fácil montaje.

[ENG] Operative office chair of fire-resistant fabric over an interior of injected foam, mesh backrest in injected technical polymer. Technical polymer base and robust swivelling mechanism for daily use. Lumbar adjustment. Standard adjustable arms. Admits RD-917 parquet wheels. Easy assembly.

[DE] Bürostuhl für den täglichen Gebrauch. Polsterschaum-Sitzfläche, mit feuerhemmendem Stoffbezug. Rückenlehne aus Kunststoffspritzguss mit Netzbezug. Mit Wippmechanik und Kunststofffußgestell. Verstellbare Armlehnen serienmäßig. Kann mit Hartbodenrollen (RD-917) ausgestattet werden.

[FR] Chaise de bureau opérationnelle en toile ignifugée sur coussin en mousse injectée, dossier injecté en polymère technique tapissé en maille. Base polymère technique et robuste mécanisme basculant pour utilisation quotidienne. Réglage lombaire. Accoudoirs réglables de série. Possibilité d'installer des roues spéciales pour parquet RD-917. Montage facile.

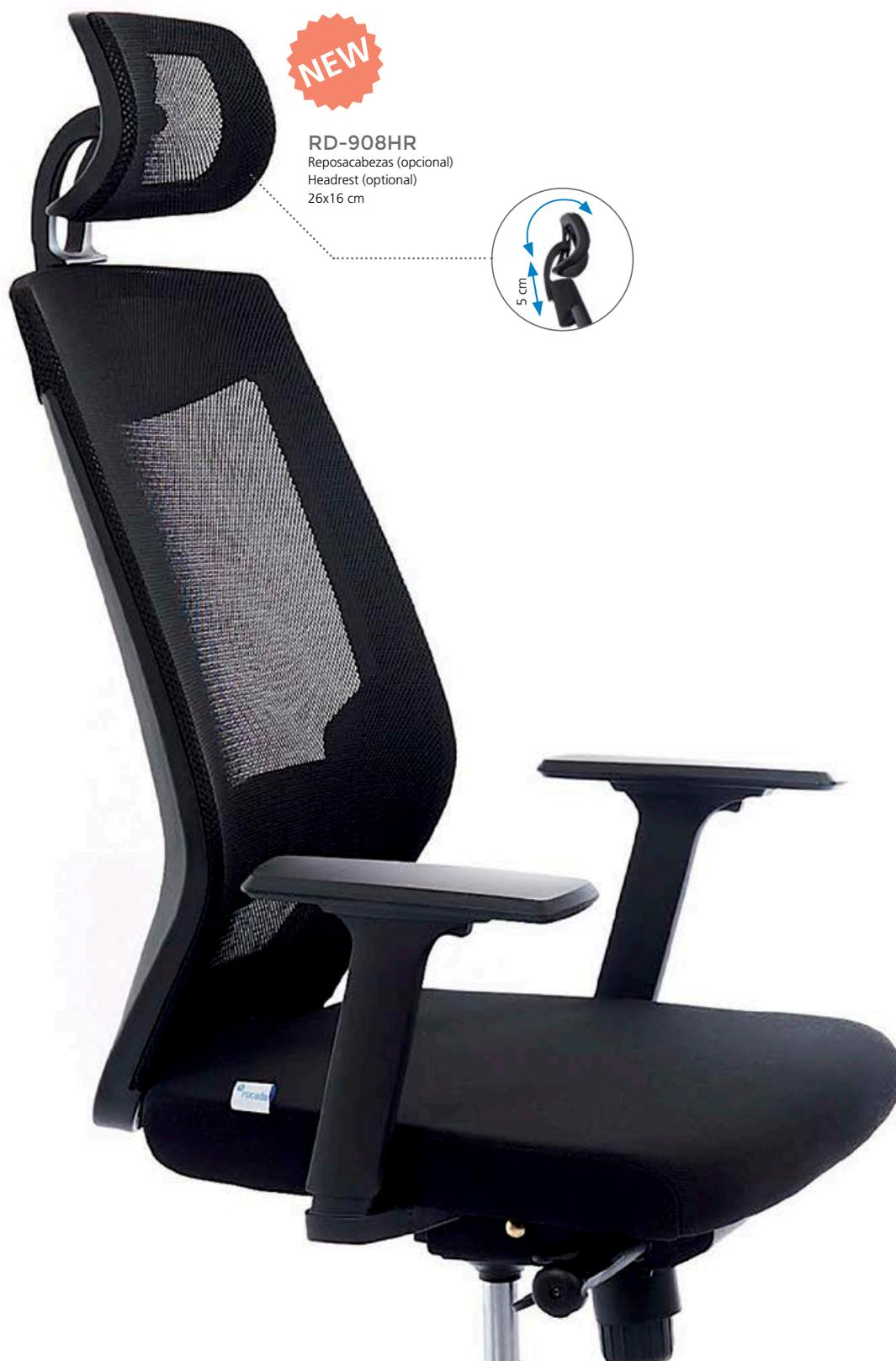



Máx
125 kg



*Bajo pedido / *On request / *Auf Anforderung / *Sur demande

Medidas / Sizes (cm)

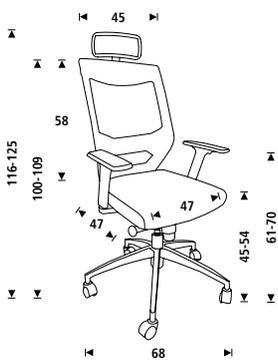

RD-917
Opcional / Optional



Ruedas parquet Ø60mm
Laminated floor castors Ø60mm
Hartbodenrollen Ø60mm
Roulettes parquet Ø60mm

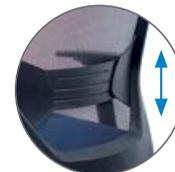

Regulación lumbar
Lumbar height
adjustable system



Brazos regulables en altura
Height adjustable armrest

Ref.	cm (embalaje / packaging)	kg / m ³ (embalaje / packaging)
RD-908-1*	68x63x29	17,50 kg / 0,124 m ³
RD-908-2*	68x63x29	17,50 kg / 0,124 m ³
RD-908-3	68x63x29	17,50 kg / 0,124 m ³
RD-908-4	68x63x29	17,50 kg / 0,124 m ³
RD-908-5*	68x63x29	17,50 kg / 0,124 m ³
RD-908-6*	66x63x33	17,50 kg / 0,124 m ³
RD-908HR reposacabezas opcional / headrest optional	35x25x12	0,5 kg / 0,010 m ³
RD-917 (Opcional / Optional)	11x6,3x25	0,5 kg / 0,001 m ³

SILLAS OFICINA

OFFICE CHAIRS • BÜROSTÜHLE • SIÈGES DE BUREAU

[ESP] Silla de oficina operativa con asiento tapizado con tela ignífuga sobre interior de espuma inyectada, respaldo inyectado en polímero técnico tapizado con malla. Base en polímero técnico y robusto mecanismo basculante para un uso diario. Brazos regulables de serie. Admite ruedas de parquet RD-917. Fácil montaje.

[ENG] Operative office chair of fire-resistant fabric over an interior of injected foam, mesh backrest in injected technical polymer. Technical polymer base and robust swivelling mechanism for daily use. Standard adjustable arms. Admits RD-917 parquet wheels. Easy assembly.

[DE] Bürostuhl für den täglichen Gebrauch. Polsterschaum-Sitzfläche, mit feuerhemmendem Stoffbezug. Rückenlehne aus Kunststoffspritzguss mit Netzbezug. Mit Wippmechanik und Kunststofffußgestell. Verstellbare Armlehnen serienmäßig. Kann mit Hartbodenrollen (RD-917) ausgestattet werden.

[FR] Chaise de bureau opérationnelle en toile ignifugée sur coussin en mousse injectée, dossier injecté en polymère technique tapissé en maille. Base polymère technique et robuste mécanisme basculant pour utilisation quotidienne. Accoudoirs réglables de série. Possibilité d'installer des roues spéciales pour parquet RD-917. Montage facile.



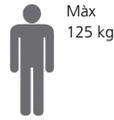

*Bajo pedido / *On request / *Auf Anforderung / *Sur demande

Medidas / Sizes (cm)

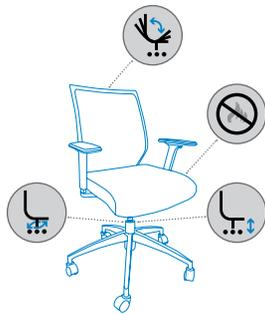
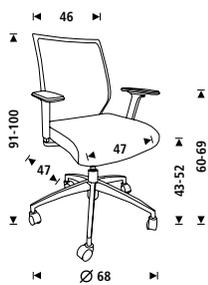

RD-917
Opcional / Optional



Ruedas parquet Ø60mm
Laminated floor castors Ø60mm
Hartbodenrollen Ø60mm
Roulettes parquet Ø60mm



Brazos regulables en altura
Height adjustable armrest

Ref.	cm (embalaje / packaging)	kg / m ³ (embalaje / packaging)
RD-907-1*	64x63x34	14 kg / 0,137 m ³
RD-907-2*	64x63x34	14 kg / 0,137 m ³
RD-907-3	64x63x34	14 kg / 0,137 m ³
RD-907-4	64x63x34	14 kg / 0,137 m ³
RD-907-5*	64x63x34	14 kg / 0,137 m ³
RD-907-6*	64x63x34	14 kg / 0,137 m ³
RD-917 (Opcional / Optional)	11x6,3x25	0,5 kg / 0,001 m ³

SILLAS OFICINA

OFFICE CHAIRS • BÜROSTÜHLE • SIÈGES DE BUREAU

[ESP] Silla oficina operativa con asiento tapizado con tela sobre interior de espuma inyectada, base de polímero técnico y mecanismo de contacto permanente. Respaldo regulable en altura. Brazos de serie regulables en altura. Admite ruedas de parquet RD-917. Fácil montaje.

[ENG] Office chair made of fabric on the inside of injected foam, technical polymer base and permanent contact mechanism. Adjustable backrest in height. Adjustable arms in height included. It admits wheels of RD-917. Easy to assemble.

[DE] Bürostuhl mit Polsterschaum-Sitzfläche und Stoffbezug, Basis aus technischem Kunststoff und Permanentkontaktmechanik. Höhenverstellbare Rückenlehne. Serienmäßig mit höhenverstellbaren Armlehnen. Kann mit Parkettrollen RD-917 ausgestattet werden. Einfache Montage.

[FR] Chaise de bureau opérationnelle en tissu sur intérieur mousse injectée, base en polymère technique et mécanisme de contact permanent. Dossier réglable en hauteur. Accoudoirs de série réglables en hauteur. Possibilité d'installer des roues spéciales pour parquet RD-917. Montage facile.



NEW



Màx
125 kg



1



Gris / Grey
Grau / Gris

2



Burdeos / Burgundy
Burgund / Bordeaux

3



Azul / Blue
Blau / Bleu

4



Negro / Black
Schwarz / Noir

Medidas / Sizes (cm)

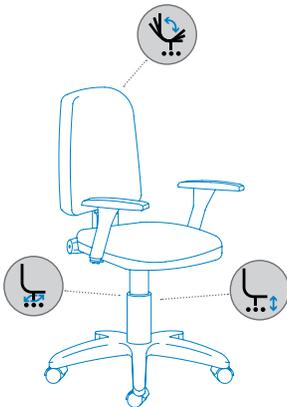
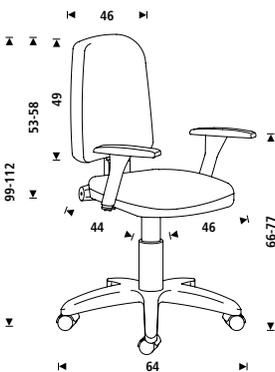

RD-917

Opcional / Optional



Ruedas parquet Ø60mm
Laminated floor castors Ø60mm
Hartbodenrollen Ø60mm
Roulettes parquet Ø60mm



Regulación respaldo
Backrest regulation



Brazos regulables en altura
Height adjustable armrest

Ref.	cm (embalaje / packaging)	kg / m ³ (embalaje / packaging)
● RD-911-1+958	64x63x34	14 kg / 0,137 m ³
● RD-911-2+958	64x63x34	14 kg / 0,137 m ³
● RD-911-3+958	64x63x34	14 kg / 0,137 m ³
● RD-911-4+958	64x63x34	14 kg / 0,137 m ³
RD-917 (Opcional / Optional)	11x6,3x25	0,5 kg / 0,001 m ³

SILLAS OFICINA

OFFICE CHAIRS • BÜROSTÜHLE • SIÈGES DE BUREAU

[ESP] Silla oficina operativa con asiento tapizado con tela sobre de espuma inyectada, base de polímero técnico y mecanismo de contacto permanente. Brazos de serie según modelo. Admite ruedas de parquet RD-917. Fácil montaje.

[ENG] Office chair with fabric deep cushioned seat and back. Polymer base and permanent contact mechanism. Includes armrest. Compatible with RD-917 parquet castors. Easy assembly.

[DE] Standard - Bürostuhl mit Kunststoffgestell und feuerfestem Stoffbezug. Permanentkontaktmechanik Leichte Montage.

[FR] Chaise de bureau, toile ignifugé et mécanisme de contact permanent. Accoudoirs de série. Facile à monter.



RD-930/4 + 956

Con brazos
With armrest

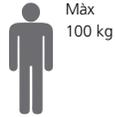

Máx
100 kg



8h

RD-930/4
Sin brazos
Without armrest



1



Gris / Grey
Grau / Gris

2



Burdeos / Burgundy
Burgund / Bordeaux

3



Azul / Blue
Blau / Bleu

4



Negro / Black
Schwarz / Noir

Medidas / Sizes (cm)

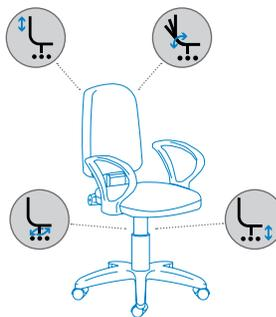
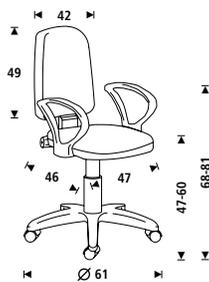
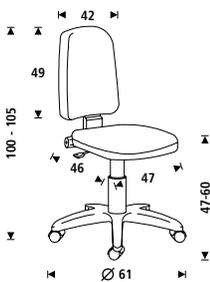

RD-917

Opcional / Optional



Ruedas parquet Ø60mm
Laminated floor castors Ø60mm
Hartbodenrollen Ø60mm
Roulettes parquet Ø60mm



Regulación respaldo
Backrest regulation

	Ref.	cm (embalaje / packaging)	kg / m ³ (embalaje / packaging)
con brazos / with armrest	● RD-930/1 + 956	60x57x27	12,25 kg / 0,092 m ³
	● RD-930/2 + 956	60x57x27	12,25 kg / 0,092 m ³
	● RD-930/3 + 956	60x57x27	12,25 kg / 0,092 m ³
	● RD-930/4 + 956	60x57x27	12,25 kg / 0,092 m ³
sin brazos / without armrest	● RD-930/1	60x57x27	9,75 kg / 0,092 m ³
	● RD-930/2	60x57x27	9,75 kg / 0,092 m ³
	● RD-930/3	60x57x27	9,75 kg / 0,092 m ³
	● RD-930/4	60x57x27	9,75 kg / 0,092 m ³
RD-917 (Opcional / Optional)		11x6,3x25	0,5 kg / 0,001 m ³

SILLA COLABORATIVA

COLLABORATIVE CHAIRS • SEMINARSTÜHLE UND TEAMSTÜHLE
SIÈGE DE TRAVAIL COLLABORATIF

[ESP] Nueva silla colaborativa con base y cuerpo central en polímero técnico flexible con asiento y respaldo tapizado. Pala de trabajo de grandes dimensiones que permite ordenadores portátiles, ajustable a derecha e izquierda sin necesidad de desmontaje gracias a su sistema de rotación 360°. Su diseño permite un acceso fácil y gracias a sus brazos incorporados se consigue una máxima comodidad. La base permite almacenar todo tipo de objetos y sus ruedas facilitan el desplazamiento sin esfuerzo entre diferentes áreas.

[ENG] New collaborative chair with flexible seat, without pneumatic adjustments to worry about keeps users comfortable. Personal work surface is adjustable, non-handed, and large enough to support digital handbook. Open seat design offers easy acces, while arms serve as backpack hooks. Folding clipboard, expands seat space for you at anytime. Swivel seat keeps open sightlines between studen and instructor. Base keeps backpacks and personal belongings out of the sisle. Casters lend mobility for quick, easy transitions between rooms.

[DE] Neuartiger Meeting und Hörsaalstuhl mit integrierter, flexibel einstellbarer Arbeitsplatte 50x30cm. Die Arbeitsplatte kann links-/ rechtsseitig um jeweils 180° gedreht werden Weiße Kunststoff-Sitzschale mit schwarzer Sitzpolsterung. Sitz ist 360° drehbar. Die Gestell-Konstruktion ist aus grauem Kunststoff gefertigt und bietet Ablage-Platz, z.B. für eine Tasche oder Unterlagen. Insgesamt 6 Laufrollen sorgen für einen sicheren Stand, aber ebenso für ein schnelles Verbringen von einem Raum zum anderen.

[FR] Nouveau siège de travail collaboratif avec base et corps central en polymère technique souple, et assise et dossier tapissés. Tablette de grandes dimensions qui permet de poser un ordinateur portable, réglable sur la droite et la gauche sans besoin de la démonter, grâce à son système de rotation à 360°. Son design permet de s'asseoir facilement et ses accoudoirs incorporés offrent un confort maximum. La base peut accueillir tous types d'objets et les roulettes permettent de déplacer le fauteuil sans effort d'une pièce à l'autre





Ver vídeo
See video



Carcasa monobloc en blanco y tapizado según referencia
White monoblock body and upholstered according each ref.

Para medidas y aplicaciones especiales, consultar a Rocada.
For special sizes and uses contact Rocada.
Sonderabmessungen und Sonderanfertigungen auf Anfrage.
Veuillez contacter Rocada pour des dimensions et applications spécifiques.



*Bajo pedido / *On request / *Auf Anforderung / *Sur demande

Medidas / Sizes (cm)

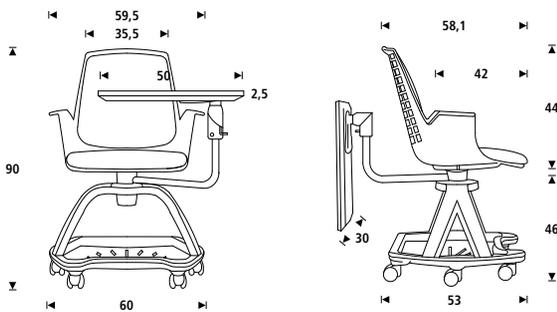

RD-928P3

Pedido mínimo consultar Rocada.
MOQ contact Rocada



Medidas de bandeja:
Personal work surface size:
49,7x29,7cm

Ref.	cm (embalaje / packaging)	kg / m ³ (embalaje / packaging)
 RD-928-1*	64x63x34	14 kg / 0,137 m ³
 RD-928-2*	64x63x34	14 kg / 0,137 m ³
 RD-928-3	64x63x34	14 kg / 0,137 m ³
 RD-928-4	64x63x34	14 kg / 0,137 m ³
 RD-928-5*	64x63x34	14 kg / 0,137 m ³
 RD-928-6*	64x63x34	14 kg / 0,137 m ³
 RD-928P3 (para instalaciones / for tenders)	70x60x50	14 kg / 0,210 m ³

SILLAS TRANSFORMABLES

TRANSFORMABLE CHAIRS • TRANSFORMIERBARE STÜHLE
CHAISES TRANSFORMABLES

[ESP] Silla multifuncional plegable y transformable en mesa con un solo click. La mejor opción para salas polivalentes. Realizada en polímero técnico con base metálica cromada. Se entrega montada.

[ENG] Foldable, multifunctional chair, transformable into a table with only one click. The best option for multiuse rooms. Made of technical polymer with chromed metal base. Comes assembled.

[DE] Der vielseitige Transformer - Stuhl – lässt sich im Handumdrehen zum Tisch umwandeln! Die ideale Lösung für Mehrzweckräume mit unterschiedlichen Nutzungsformen! Stabile Kunststoffschale mit verchromtem Metallgestell. Stapelbar. Auslieferung erfolgt im vormontierten Zustand.

[FR] Fauteuil multifonctions pliable et transformable en table à l'aide d'une simple pression. Le choix idéal pour les salles polyvalentes. Polymère technique sur base métallique chromée. Empilable. Livrée montée.



UNE EN 13761
UNE EN 1022





NEW

RD-992TY
Carro para sillas (máx 8)
Trolley for chair (max 8)



Rueda con freno
Castor with brake

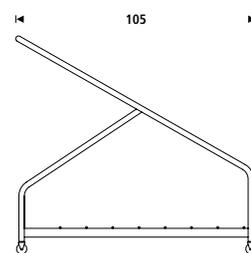
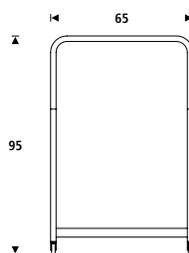

Medidas / Sizes (cm)

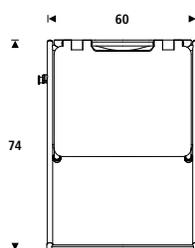
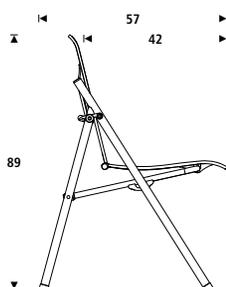
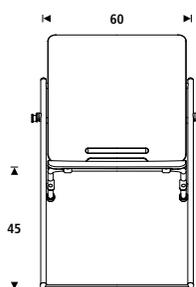

Ref.	cm (embalaje / packaging)	kg / m ³ (embalaje / packaging)
RD-992V19-4 (2u.)	105x61x30	21 kg / 0,192 m ³
RD-992TY	110x97x65	12 kg / 0,693 m ³ (Max 8 sillas / chairs)

SILLA CONFIDENTE

VISITOR'S CHAIR • BESUCHERSTUHL • CHAISE DE VISITEUR

[ESP] Silla confidente profesional tapizada en tela ignífuga, ergonómica y con estructura cromada, ideal para despachos de dirección. Incorpora brazos de serie. Fácil montaje.

[ENG] Professional office chair with flame retardant fabric, ergonomic with chromed based structure. Perfect for Director's offices. Incorporates arms. Comes mounted.

[DE] Graziler Besucher- und Konferenzstuhl mit Freischwinger-Effekt. Sitzfläche und Rückenlehne mit feuerhemmendem, chargiertem Stoffbezug in 3 attraktiven Farben. Verchromtes Stuhlgestell mit integrierten Armlehnen.

[FR] Siège visiteur tapissé de toile ignifugee, ergonomique, avec structure chromée, idéale pour les bureaux de direction. Comprend des bras de série. Livré monté.



UNE EN 13761
UNE EN 1022





*Bajo pedido / *On request / *Auf Anforderung / *Sur demande

Medidas / Sizes (cm)

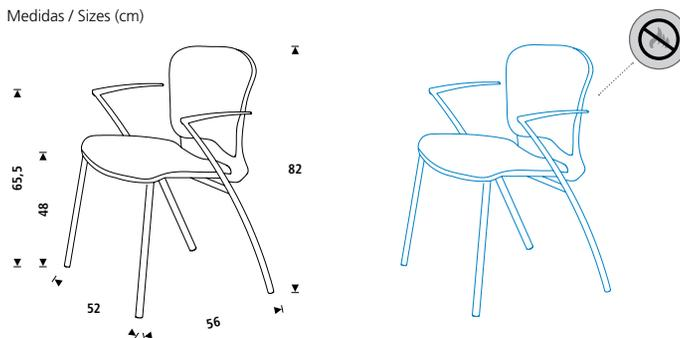

Ref.	cm (embalaje / packaging)	kg / m ³ (embalaje / packaging)
RD-966/1* (2u.)	72x59x56	18 kg / 0,238 m ³
RD-966/2* (2u.)	72x59x56	18 kg / 0,238 m ³
RD-966/3 (2u.)	72x59x56	18 kg / 0,238 m ³
RD-966/4 (2u.)	72x59x56	18 kg / 0,238 m ³
RD-966/5* (2u.)	72x59x56	18 kg / 0,238 m ³
RD-966/6* (2u.)	72x59x56	18 kg / 0,238 m ³

SILLA CONFIDENTE

VISITOR'S CHAIR • BESUCHERSTUHL • CHAISE DE VISITEUR

[ESP] Silla confidente de oficina con el asiento tapizado con tela ignífuga sobre interior de espuma inyectada y el respaldo realizado en polímero técnico inyectado. Estructura metálica reforzada pintada en epoxy color gris. Fácil montaje.

[ENG] Visitor/boardroom chair with flame proof padded fabric seat, generous size. Polymer mesh back. Metallic base reinforced and painted in grey epoxy color. Easy assembly.

[DE] Besucherstuhl im modernen Design mit Stoffbezug. Polsterung aus atmungsaktivem Formschaum, Rückenlehne aus Polymergeflecht. Lackiertes Metallgestell. Leichte Montage.

[FR] Chaise visiteur de bureau, assise en toile ignifugée sur coussin de mousse injectée et dossier en polymère technique injecté. Piètement laqué. Facile à monter.





*Bajo pedido / *On request / *Auf Anforderung / *Sur demande

Medidas / Sizes (cm)

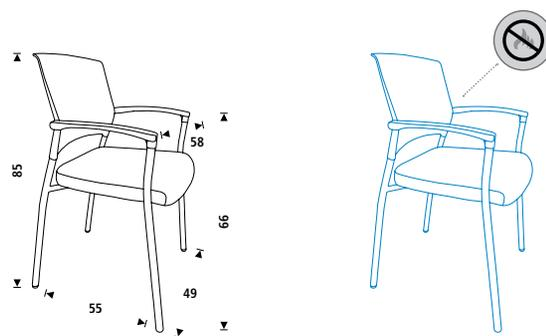

Ref.	cm (embalaje / packaging)	kg / m ³ (embalaje / packaging)
RD-906/1* (2u.)	65,5x61x55	13,50 kg / 0,219 m ³
RD-906/2* (2u.)	65,5x61x55	13,50 kg / 0,219 m ³
RD-906/3 (2u.)	65,5x61x55	13,50 kg / 0,219 m ³
RD-906/4 (2u.)	65,5x61x55	13,50 kg / 0,219 m ³
RD-906/5* (2u.)	65,5x61x55	13,50 kg / 0,219 m ³
RD-906/6* (2u.)	65,5x61x55	13,50 kg / 0,219 m ³

SILLA CONFIDENTE

VISITOR'S CHAIR • BESUCHERSTUHL • CHAISE DE VISITEUR

[ESP] Silla confidente con estructura tubular de acero cromado y carcasa monobloc de polímero técnico. Dispone de sistema de anclaje en la parte inferior de la estructura para construir y alinear filas de sillas en salas polivalentes, conferencias, pasillos, etc.

[ENG] Visitor chair with tubular structure of chrome-plated steel and monoblock body of technical polymer. It has a anchorage system in the lower part of the structure to align rows of chairs in multi-purpose rooms, conferences, etc.

[DE] Verkettbarer Konferenzstuhl mit verchromtem Stahlrohrgestell. Rückenlehne und Sitzschale aus Kunststoff...

[FR] Chaise de visiteur avec structure tubulaire en acier chromé et carcasse monobloc en polymère technique. Pourvue d'un système d'ancrage sur la partie inférieure pour effectuer et aligner des rangées de chaises en salles polyvalentes, conférence, etc, ...





Estructura con sistema de unión incluido
Structure with joint system

Medidas / Sizes (cm)

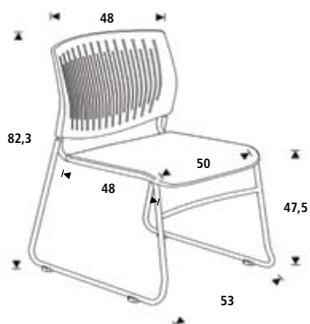

NEW



1A01606
Carro para sillas
(máx. 20 sillas)
Trolley for chairs
(20 chairs max.)

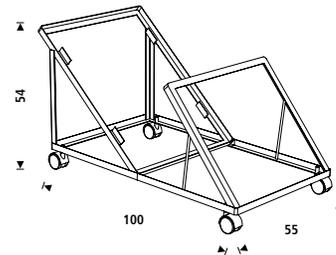

Ref.	cm (embalaje / packaging)	kg / m ³ (embalaje / packaging)
RD-968-4	83x58x52	6 kg / 0,250 m ³
1A01606	101x57,5x58	11,17 kg / 0,250 m ³ (Max 20 sillas / chairs)

SILLA CONFIDENTE

VISITOR'S CHAIR • BESUCHERSTUHL • CHAISE DE VISITEUR

[ESP] Silla confidente con base metálica reforzada pintada en epoxy color negro. Con asiento y respaldo tapizado en tela. Viene montada.

[ENG] Fabric conference chair. Seat and back upholstered. Metallic base reinforced and painted in black epoxy color. Comes assembled.

[DE] Attraktiver Stapelstuhl mit Stoffbezug und lackiertem Metallgestell.

[FR] Chaise de bureau ECO en structure tapissé. Base métallique laqué. Vienne assemblé.oues de parquet RD-917. Livrée montée.





RD-965TY

Carro para sillas (máx. 9 sillas)
Trolley for chairs (9 chairs max.)
(pag. 67)



Gris / Grey
Grau / Gris

Burdeos / Burgundy
Burgund / Bordeaux

Azul / Blue
Blau / Bleu

Negro / Black
Schwarz / Noir

Medidas / Sizes (cm)

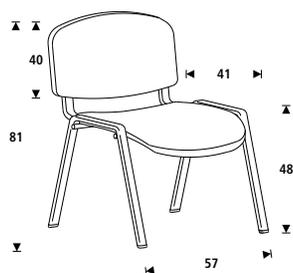

RD-977

Opcional / Optional



RD-978

Opcional / Optional



RD-979

Opcional / Optional



RD-977 (Pala derecha / Right work surface). Medidas / Sizes: 34 x 20 cm.

RD-978 (Pala izquierda / Left work surface). Medidas / Sizes: 27 x 27 cm.

Ref.	cm (embalaje / packaging)	kg / m ³ (embalaje / packaging)
RD-965/1	81x60x54	5,20 kg / 0,262 m ³
RD-965/2	81x60x54	5,20 kg / 0,262 m ³
RD-965/3	81x60x54	5,20 kg / 0,262 m ³
RD-965/4	81x60x54	5,20 kg / 0,262 m ³
RD-977 (Pala derecha / Right tray)	35x30x15	3,8 kg / 0,075 m ³
RD-978 (Pala izquierda / Left tray)	35x30x15	3,8 kg / 0,075 m ³
RD-979 (Brazos / Armrest)	35x30x15	3,8 kg / 0,075 m ³

SILLA CONFIDENTE

VISITOR'S CHAIR • BESUCHERSTUHL • CHAISE DE VISITEUR

[ESP] Silla confidente con respaldo y asiento realizado en madera. Estructura metálica reforzada pintada en epoxy color gris. Viene montada.

[ENG] Conference chair. Wood structure. Metallic base reinforced and painted in grey epoxy color. Comes assembled.

[DE] Stapelstuhl. Sitz und Rückenlehne aus Schichtholz. Lackiertes Metallgestell. Fertig montiert.

[FR] Chaise de bureau ECO en structure bois. Base métallique laquée. Livrée montée.





RD-977
Opcional / Optional

RD-978
Opcional / Optional

RD-979
Opcional / Optional



RD-977 (Pala derecha / Right work surface). Medidas / Sizes: 34 x 20 cm.

RD-978 (Pala izquierda / Left work surface). Medidas / Sizes: 27 x 27 cm.



Medidas / Sizes (cm)

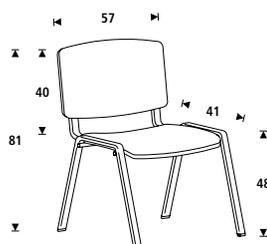

RD-965TY

Carro para sillas (máx. 9 sillas)
Trolley for chairs (9 chairs max.)
(pag. 67)



Ref.	cm (embalaje / packaging)	kg / m ³ (embalaje / packaging)
RD-974S	81x60x54	6 kg / 0,262 m ³
RD-977 (Pala derecha / Right tray)	35x30x15	3,8 kg / 0,075 m ³
RD-978 (Pala izquierda / Left tray)	35x30x15	3,8 kg / 0,075 m ³
RD-979 (Brazos / Armrest)	35x30x15	3,8 kg / 0,075 m ³

SILLA CONFIDENTE

VISITOR'S CHAIR • BESUCHERSTUHL • CHAISE DE VISITEUR

[ESP] Silla confidente con respaldo y asiento de polímero técnico y base metálica reforzada pintada en epoxy color negro. Viene montada.

[ENG] Conference chair with plastic structure. Metallic base reinforced and painted in black epoxy color. Comes assembled.

[DE] Stapelstuhl mit Kunststoff Sitz und lackiertem Metallgestell.

[FR] Chaise de bureau ECO en structure plastique. Base métallique laquée. Livrée montée.





RD-965TY

Carro para sillas (máx. 9 sillas)
Trolley for chairs (9 chairs max.)
(pag. 67)



Gris / Grey
Grau / Gris

Rojo / Red
Rot / Rouge

Azul / Blue
Blau / Bleu

Negro / Black
Schwarz / Noir

Medidas / Sizes (cm)

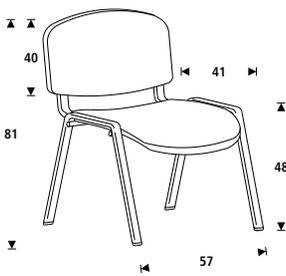

RD-977

Opcional / Optional



RD-978

Opcional / Optional



RD-979

Opcional / Optional



RD-977 (Pala derecha / Right work surface). Medidas / Sizes: 34 x 20 cm.

RD-978 (Pala izquierda / Left work surface). Medidas / Sizes: 27 x 27 cm.

Ref.	cm (embalaje / packaging)	kg / m ³ (embalaje / packaging)
● RD-975V15-1	81x60x54	5,20 kg / 0,262 m ³
● RD-975V15-2	81x60x54	5,20 kg / 0,262 m ³
● RD-975V15-3	81x60x54	5,20 kg / 0,262 m ³
● RD-975V15-4	81x60x54	5,20 kg / 0,262 m ³
RD-977 (Pala derecha / Right tray)	35x30x15	3,8 kg / 0,075 m ³
RD-978 (Pala izquierda / Left tray)	35x30x15	3,8 kg / 0,075 m ³
RD-979 (Brazos / Armrest)	35x30x15	3,8 kg / 0,075 m ³

SILLA CONFIDENTE

VISITOR'S CHAIR • BESUCHERSTUHL • CHAISE DE VISITEUR

[ESP] Carro para sillas serie RD-965, RD-974S y RD-975V15. Permite el almacenamiento y el correcto transporte de 9 sillas sin esfuerzo. Realizado en tubo de acero. Se entrega montado.

[ENG] Trolley for chairs RD-965 / RD-974S / RD-975V15 series. It allows to store and the best way to transport 9 units. Made in Epoxy painted steel tube and sheet. Allows to stack up to 9 chairs.

[DE] Stuhlwagen Serie RD-965, RD-974S und RD-975V15. Ermöglicht die Aufbewahrung und den ordnungsgemäßen Transport von 9 Stühlen ohne große Anstrengung. Aus Stahlrohr gefertigt. Wird montiert geliefert.

[FR] Chariot pour chaises série RD-965, RD-974S et RD-975V15. Destiné au stockage et au transport de 9 chaises sans effort. Fabriqué en tube d'acier. Livré monté.



NEW



Medidas / Sizes (cm)

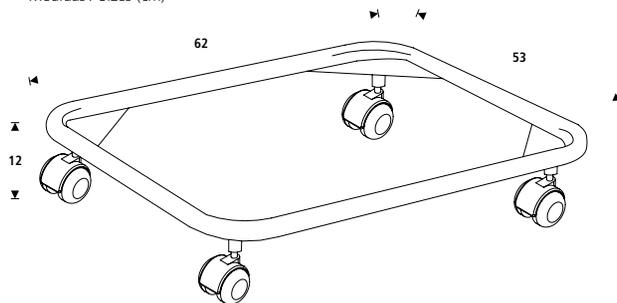

Ref.	cm (embalaje / packaging)	kg / m ³ (embalaje / packaging)
RD-965TY (máx 9 sillas / chairs)	65x55x8	6,00 kg / 0,028 m ³

SILLA CONFIDENTE

VISITOR'S CHAIR • BESUCHERSTUHL • CHAISE DE VISITEUR

[ESP] Silla de oficina plegable con asiento, respaldo y estructura metálica ideal para salas polivalentes, reuniones... Viene montada.

[ENG] Folding office chair with metal structure, ideal for multi-purpose rooms, meetings, etc. Comes assembled.

[DE] Bürokippstuhl mit Metallgestell für Mehrzweckräume, Tagungen, usw. Wird montiert geliefert.

[FR] Chaise de bureau pliante en structure métallique, idéale pour salles polyvalentes, réunions... Livrée montée.





Medidas / Sizes (cm)

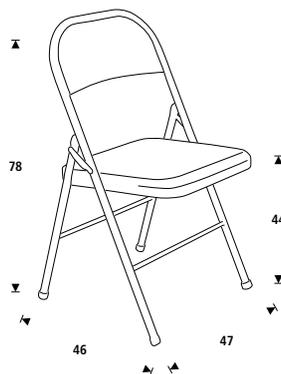

Ref.	cm (embalaje / packaging)	kg / m ³ (embalaje / packaging)
RD-921V15-4 (2 u.)	97x48x11	7,35 kg / 0,051 m ³

TABURETES

STOOLS • HOCKER • TABOURETS

[ESP] Taburete móvil con asiento y respaldo realizado en polímero técnico de alta resistencia para usos exigentes con mecanismo básico. Pistón de gas de largo recorrido. Base de polímero técnico con tacos antideslizantes. Admiten ruedas de parquet. Fácil montaje.

[ENG] Technical polymer back and seat mobile stool to hard uses with basic mechanism. Long run gas lift. Polymer technical base with stud slip. Optional castors or laminated floor castors. Easy assembly.

[DE] Sitzfläche und Rückenlehne aus widerstandsfähigen, pflegeleichten Kunststoff. Ergonomisch geformt. Stabiles Fünffußgestell mit Bodengleitern und Fußring. Permanentkontaktmechanik mit langer Gasdruckfeder. Rollen für Teppich- oder Hartböden als Zubehör erhältlich.

[FR] Tabouret mobile, assise et dossier en polymère technique haute résistance pour utilisation quotidienne avec mécanisme standard. Piston longue course. Base en polymère technique avec crampons anti-dérapants. Possibilité de roues standard ou de roues spécial parquet. Montage facile.





Màx
125 kg

8h



Regulación altura reposa pies
Footrest height adjustable

Medidas / Sizes (cm)

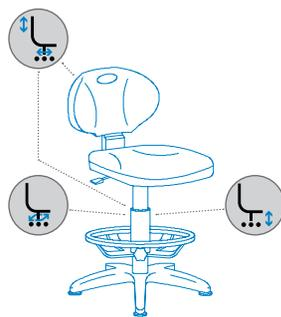
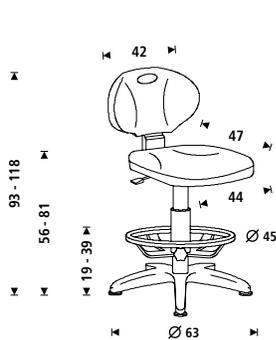

RD-917
Opcional / Optional



Ruedas parquet Ø60mm
Laminated floor castors Ø60mm
Hartbodenrollen Ø60mm
Roulettes parquet Ø60mm

Ref.	cm (embalaje / packaging)	kg / m ³ (embalaje / packaging)
RD-925N	64x63x33	12,80 kg / 0,133 m ³
RD-917	11x6,3x25	0,5 kg / 0,001 m ³

TABURETES

STOOLS • HOCKER • TABOURETS

[ESP] Taburete móvil de tela ignífuga y base metálica, con mecanismo básico. Pistón de gas de largo recorrido. Fácil montaje.

[ENG] Fire-retardant fabric mobile stool with metal base and basic mechanism. Long run gas piston. Easy assembled.

[DE] Mobiler Zeichenstuhl mit Metall-Fussgestell mit fester Fusstütze., feuerfestem Stoffbezug, langer Gasdruckfeder

[FR] Chaise mobile, tissu ignifuge, base métallique, piston pneumatique de grande amplitude. Montage facile.





Màx
100 kg

5h



Medidas / Sizes (cm)

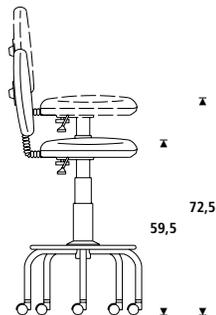
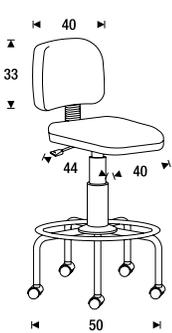

Ref.	cm (embalaje / packaging)	kg / m ³ (embalaje / packaging)
RD-980	59x58x35	9,65 kg / 0,120 m ³

TABURETES

STOOLS • HOCKER • TABOURETS

[ESP] Taburetes con estructura metálica y base de 5 pies. El asiento se regula mediante husillo giratorio. Fácil montaje.

[ENG] Stools with metallic structure and a 5-foot base. The seat is adjusted with a rotating screw. Easy assembled.

[DE] Hocker mit Metallstruktur und 5-füssigem Unterteil. Sitzhöhenverstellung mittels Spindel.

[FR] Tabourets en structure métal, avec base à 5 pieds. La hauteur se règle à l'aide de la tige giratoire.



RD-900/2



Max
125 kg



RD-900



RD-900/1

RD-900



Tapizado
Upholstered
Gepolstert
Tapissé

RD-900/1



Plástico
Plastic
Plastik
Plastique

RD-900/2



Madera
Wood
Holz
Bois

RD-916



Juego de 5 ruedas.
Kit of 5 castors.
Satz mit 5 Rollen.
Jeu de 5 roulettes.

Medidas / Sizes (cm)

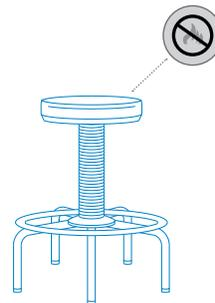
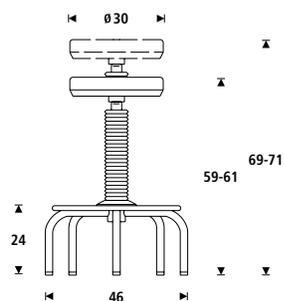

Ref.	cm (embalaje / packaging)	kg / m ³ (embalaje / packaging)
RD-900	49x48x33	6 kg / 0,078 m ³
RD-900/1	49x48x33	5,8 kg / 0,078 m ³
RD-900/2	49x48x33	4,8 kg / 0,078 m ³
RD-916	25x11x5,3	0,5 kg / 0,001 m ³

SILLAS GAMING

GAMING CHAIRS • GAMING STÜHLE • SIÈGES GAMING

[ESP] Silla GAMING PROFESIONAL de gran diseño deportivo, confort y versatilidad pensada para disfrutar en tus momentos de ocio o de trabajo diario. Tapizada en simil piel. Robusta base de polímero técnico (nylon) con ruedas de gran diseño (60mm de diámetro). Mecanismo basculante de grandes prestaciones para uso diario. Respaldo y asientos de espuma inyectada con formas ergonómicas para conseguir mantener posturas corporales correctas en todo momento. Cojines lumbar y cervical regulables que aumentan el confort. Respaldo reclinable 155° que permite fijar el ángulo de inclinación deseado. Reposacabezas integrado. Brazos regulables de serie

[ENG] GAMING PROFESSIONAL chair with great sporty design, comfort and versatility designed to enjoy your leisure time or daily work. Upholstered in imitation leather. Robust technical polymer base (nylon) with large design wheels (60mm diameter). Rocker mechanism for daily use. Backrest and injected foam seats with ergonomic shapes to achieve correct body postures at all times. Adjustable cervical and lumbar cushions that increase comfort. 155° reclining backrest that allows you to set the desired angle of inclination. Integrated headrest. Adjustable arms.

[DE] Der Stuhl GAMING PROFESIONAL, mit ausgeprägt sportlichem Design, hohem Komfort und vielseitigen Einsatzmöglichkeiten, ist sowohl für Freizeit als auch tägliche Arbeit gedacht. Bezug aus Lederimitat. Robuste Basis aus technischem Kunststoff (Nylon) mit großen Rollen (60 mm Durchmesser). Wippmechanik mit großem Leistungsumfang für den täglichen Einsatz. Rückenlehne und Sitzflächen aus gespritztem Schaum sind ergonomisch geformt, um jederzeit eine ordnungsgemäße Körperhaltung zu ermöglichen. Verstellbare Lenden- und Nackenstützen für erhöhten Komfort. 155 Grad schwenkbare Rückenlehne mit Arretierung des gewünschten Neigungswinkels. Einschließlich Kopfstütze. Verstellbare Armlehnen serienmäßig.

[FR] Chaise GAMING PROFESIONAL au design sport, associant confort et polyvalence, conçue pour vos moments de loisirs et de travail quotidiens. Tapissée en simili cuir. Robuste base en polymère technique (nylon) avec des roues de grande qualité (600 mm de diamètre). Mécanisme basculant aux grandes prestations pensé pour une utilisation quotidienne. Dossier et assise en mousse injectée aux formes ergonomiques afin que la position du corps soit correcte à tout moment. Coussin lombaire réglable et coussin cervical pour plus de confort. Dossier inclinable à 155° permettant de bloquer l'inclinaison souhaitée. Appuie-tête intégré. Accoudoirs réglables de série.





NEW

12h



2
Rojo / Red
Rot / Rouge

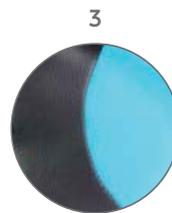

3
Azul / Blue
Blau / Bleu

Medidas / Sizes (cm)

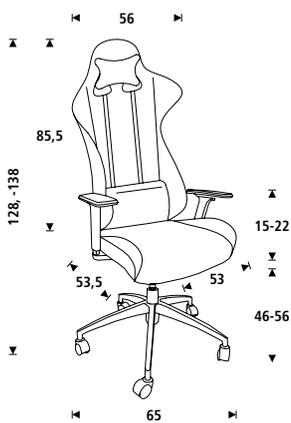

Ref.	cm (embalaje / packaging)	kg / m ³ (embalaje / packaging)
● RD-914-2	86x66x32,5	22,80 kg / 0,184 m ³
● RD-914-3	86x66x32,5	22,80 kg / 0,184 m ³

SILLAS GAMING

GAMING CHAIRS • GAMING STÜHLE • SIÈGES GAMING

[ESP] Silla GAMING STUDENT de diseño deportivo, fabricada con una cómoda espuma pensada para disfrutar en tus momentos de ocio o de trabajo. Tapizada en simil piel. Robusta base de polímero técnico (nylon) con ruedas de 50mm de diámetro. Mecanismo basculante de grandes prestaciones para uso diario. Respaldo y asientos de espuma inyectada con formas ergonómicas para conseguir mantener posturas corporales correctas en todo momento. Reposacabezas integrado. Brazos de serie.

[ENG] STUDENT GAMING chair with a sporty design, made with a comfortable foam designed to enjoy your leisure or working time. Upholstered in imitation leather. Robust technical polymer base (nylon) with wheels (50mm diameter). Great benefit like the rocking mechanism for daily use. Backrest and injected foam seats with ergonomic shapes to achieve correct body postures at all times. Integrated headrest. Arms included.

[DE] Der Stuhl GAMING STUDENT besitzt ein sportliches Design, ist aus bequemem Schaumstoff gefertigt und sowohl für Freizeit als auch Arbeit gedacht. Bezug aus Lederimitat. Robuste Basis aus technischem Kunststoff (Nylon) mit großen Rollen (50 mm Durchmesser). Wippmechanik mit großem Leistungsumfang für den täglichen Einsatz. Rückenlehne und Sitzflächen aus gespritztem Schaum sind ergonomisch geformt, um jederzeit eine ordnungsgemäße Körperhaltung zu ermöglichen. Einschließlich Kopfstütze. Armlehnen serienmäßig.

[FR] Chaise GAMING STUDENT au design sport, fabriquée en mousse agréable pensée pour profiter de vos moments de loisirs et de travail. Tapissée en simili cuir. Base en polymère technique (nylon) robuste avec des roues de grande qualité (50 mm de diamètre). Mécanisme basculant aux grandes prestations pensé pour une utilisation quotidienne. Dossier et assise en mousse injectée aux formes ergonomiques afin que la position du corps soit correcte à tout moment. Appuie-tête intégré. Accoudoirs de série.





NEW

L
8h



Rojo / Red
Rot / Rouge



Azul / Blue
Blau / Bleu

Medidas / Sizes (cm)

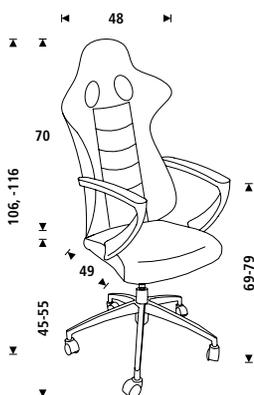

PU transpirable
Breathable PU



Brazos fijos
Fixed armrest

Ref.	cm (embalaje / packaging)	kg / m ³ (embalaje / packaging)
● RD-913-2	77x59x28	15,70 kg / 0,127 m ³
● RD-913-3	77x59x28	15,70 kg / 0,127 m ³

SILLAS GAMING

GAMING CHAIRS • GAMING STÜHLE • SIÈGES GAMING

[ESP] Silla GAMING BASIC de diseño deportivo para disfrutar en tus momentos de ocio o de trabajo. Tapizada en simil piel. Robusta base de polímero técnico (nylon) con ruedas de 50mm de diámetro. Mecanismo básico. Respaldo y asientos de espuma inyectada. Reposacabezas integrado. Brazos de serie.

[ENG] GAMING BASIC chair with sporty design to enjoy during your leisure or work moments. Upholstered in imitation leather. Robust technical polymer base (nylon) with wheels 50mm diameter. Basic mechanism Backrest and seats with injected foam. Integrated headrest. Arms included.

[DE] Der Stuhl GAMING BASIC besitzt ein sportliches Design, damit Sie sowohl Freizeit als auch Arbeit genießen können. Bezug aus Lederimitat. Robuste Basis aus technischem Kunststoff (Nylon) mit großen Rollen (50 mm Durchmesser). Basic-Mechanismus. Rückenlehne und Sitzflächen aus gespritztem Schaum. Einschließlich Kopfstütze. Armlehnen serienmäßig

[FR] Chaise GAMING BASIC au design sport pour profiter lors de vos moments de loisirs et de travail. Tapissée en simili cuir. Base en polymère technique (nylon) robuste avec des roues de grande qualité (50 mm de diamètre). Mécanisme basique. Dossier et assise en mousse injectée. Appuie-tête intégré. Accoudoirs de série.





NEW



2



Rojo / Red
Rot / Rouge

3



Azul / Blue
Blau / Bleu

Medidas / Sizes (cm)

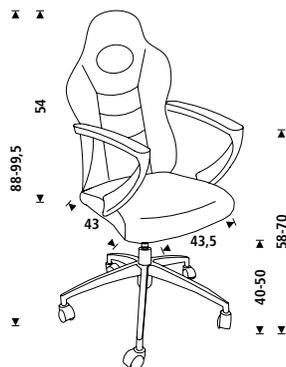

PU transpirable
Breathable PU



Brazos fijos
Fixed armrest

Ref.	cm (embalaje / packaging)	kg / m ³ (embalaje / packaging)
● RD-912-2	58,5x52,5x22,5	11,20 kg / 0,069 m ³
● RD-912-3	58,5x52,5x22,5	11,20 kg / 0,069 m ³

ACABADOS TAPIZADOS

FINISHES • OBERFLÄCHEN • FINITIONS

RD-966 • RD-944V15 • RD-939V19 • RD-937V19
RD-928 • RD-908W • RD-908 • RD-907 • RD-906

1. Gris / Grey



2. Rojo / Red

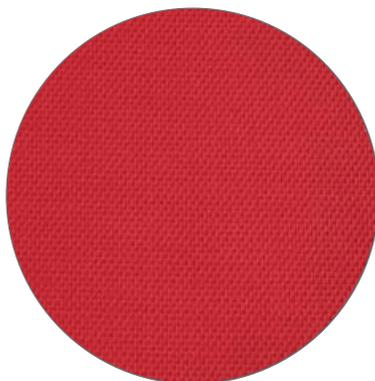

3. Azul / Blue



4. Negro / Black



5. Naranja / Orange



6. Verde / Green

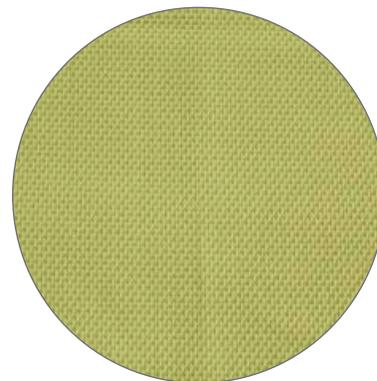

 Todos los modelos / All models

RD-998V15 • RD-990 • RD-988 • RD-987
RD-986 • RD-985 • RD-973 • RD-972 • RD-971 • RD-966

Símil Piel / Imitation leather



RD-965 · RD-930 + 956 · RD-930 · RD-911+958

1. Gris / Grey



2. Burdeos / Burgundy

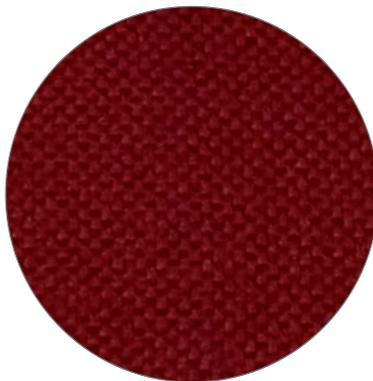

3. Azul / Blue

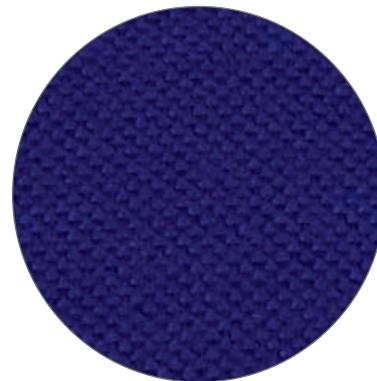

4. Negro / Black

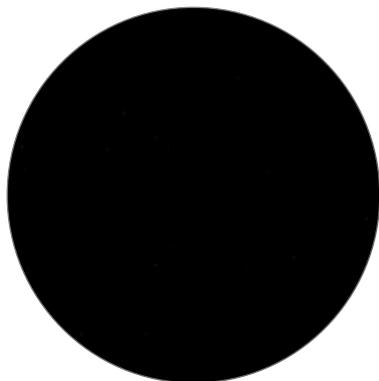

ACABADOS TAPIZADOS BE SOFT

SOFT SEATING FINISHES • SOFT SEATING OBERFLÄCHEN • FINITIONS SOFT SEATING

1804-4-1 • 1805-4-1 • 1806-4-1

4. Negro / Black



1. Gris / Grey



ACABADOS BAJO PEDIDO PANEL TRASERO · BACK PANEL FINISHES ON REQUEST

2. Rojo / Red



3. Azul / Blue

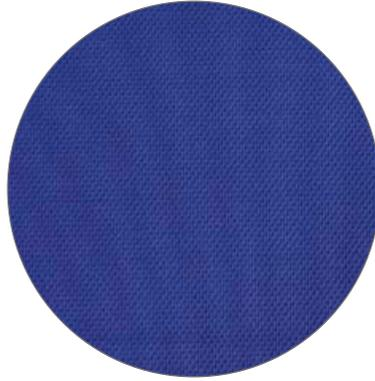

4. Negro / Black



5. Naranja / Orange

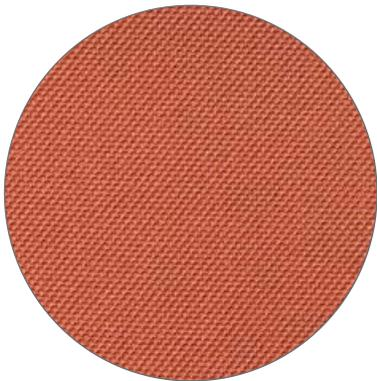

6. Verde / Green

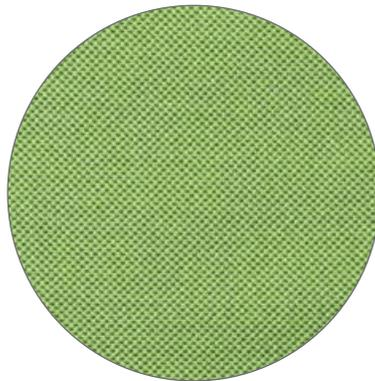



Sistema basculante

El conjunto de asiento y respaldo formando una sola unidad permite un suave balanceo hacia atrás. Se puede regular la tensión del balanceo en función del peso de la persona con el pomo de la parte inferior del asiento. Una ligera presión en la palanca de gas permite activar o desactivar este sistema basculante.



Sistema Sincro-basculante

Este mecanismo permite que asiento y respaldo se adapten sincronizadamente a los movimientos realizados por la persona sentada. Cuando el respaldo se inclina para atrás o adelante, se ajusta también de forma automática el asiento, consiguiendo una posición de trabajo perfecta en cada momento. Esta posición se puede fijar en la postura idónea en cualquier posición de su recorrido. Este sistema permite también un suave balanceo, regulable en tensión en función del peso de cada persona.

Swivelling system

The seat and the backrest are formed of one unit which permits a smooth backward movement. The regulation of the tension and balance can be adjusted according to the weight of the user with the lever under the seat. A lightweight pressure with the gas handle activates or deactivates this rocking system.

Synchro-swivelling system

This mechanism allows the seat and backrest to adjust in synchronisation with the seated person's movements. When the backrest is tilted backwards or forwards, the seat also adjusts automatically to achieve a perfect working position at all times. This position can be set at any point along its travel to give the best postural support. The system also permits gentle rocking, with resistance adjustable to take account of the user's weight.

Wippmechanik

Die Einheit von Sitz und Rückenlehne ermöglicht ein sanftes Zurückschwingen. Die Sitzneigung kann auf das jeweilige Körpergewicht eingestellt werden.

Synchronmechanik

Bei der Synchronmechanik werden Sitzfläche und Rückenlehne in einem feststehenden Winkel zueinander bewegt, der Körper wird optimal unterstützt. Eine Feststellung ist in jeder Sitzposition möglich.

Système basculant

Le siège et le dos formant une seule unité, permet un léger balancement en arrière. On peut régler la tension du balancement en fonction du poids de la personne en actionnant le bouton situé en dessous de l'assise. Une légère pression sur la poignée de gaz permet d'activer ou désactiver ce système basculant.

Système Synchro-basculant

Ce système permet d'adapter de façon synchronisée le siège et le dos en fonction des mouvements de la personne qui est assise. Lorsque le dossier est inclinée en arrière ou en avant, l'assise s'ajuste aussi automatiquement, on parvient ainsi une position de travail parfaite à tout moment. Cette position peut se caler sur la posture idéale pour toute position de son parcours. Ce système permet également d'avoir un léger balancement, dont on peut régler la tension en fonction du poids de chaque personne.



Sistema de contacto permanente.

System of permanent contact.

Permanent-Kontaktsystem. Die Rückenlehne folgt permanent dem Körper und unterstützt die Bewegung von einer zurückgelehnten in eine aufrechte Haltung.

Système de contact permanent.



Respaldo regulable en altura y profundidad respecto al asiento.

Backrest adjustable in height and depth.

Rückenlehne höhen- und tiefenverstellbar zur Sitzposition.

Dos réglable en hauteur et en profondeur par rapport au siège.



Altura regulable mediante pistón de gas, libre de mantenimiento y con sistema de suspensión.

Adjustable height through gas piston, maintenance free and through suspension system.

Höhenverstellbar mittels Gasdruckfeder, wartungsfrei.

Hauteur réglable grâce au piston à gaz, sans entretien et avec système de suspension.



Tela ignífuga 100% Modacrylic flame retardant class 1 (I) BS 5852: 1990 section 4 (cigarette and match test).

100% Modacrylic flame retardant class 1 (I) BS 5852: 1990 section 4 (cigarette and match test).

Feuerfester Stoffbezug 100% Modacrylic flame retardant class 1 (I) BS 5852: 1990 Absatz 4 (Zigaretten- und Streichholztest).

Tissu anti-feu, 100% Modacrylic retardataire de flammes, classe 1 (1) BD 5852 : 1990 section 4 (test de la cigarette et de l'allumette).



Asiento giratorio 360°.

360° Rotation seat.

360° drehbar.

Siège pivotant 360°.



Simil piel.

Imitation leather.

Leder imitat.

Simil cuir.

ÍNDICE • INDEX



pag 6



pag 10 · 1806



pag 12 · 1805



pag 14 · 1804



pag 16 · 1828



pag 18 · RD-972



pag 20 · RD-998v15



pag 22 · RD-986



pag 24 · RD-988



pag 26 · RD-990



pag 28 · RD-966



pag 30 · RD-985



pag 32 · RD-987



pag 34 · RD-944v15



pag 36 · RD-937V19



pag 38 · RD-939v19

ÍNDICE • INDEX



pag 40 · RD-908W



pag 42 · RD-908



pag 44 · RD-907



pag 46 · RD-911+958



pag 48 · RD-930



pag 48 · RD-930 + 956



pag 50 · RD-928



pag 52 · RD-992V19



pag 54 · RD-966/



pag 56 · RD-906



pag 58 · RD-968



pag 60 · RD-965



pag 62 · RD-974S



pag 64 · RD-975V15



pag 66 · RD-965TY



pag 68 · RD-921v15

ÍNDICE • INDEX



pag 70 · RD-925N



pag 72 · RD-980



pag 74 · RD-900



pag 76 · RD-914



pag 78 · RD-913



pag 80 · RD-912

PEDIDOS

NOVEDAD WEB!

Los pedidos cursados vía web tendrán un 2% de descuento hasta fin de promoción.

Si los pedidos no se tramitan a través de la web deben de efectuarse siempre por escrito.

LISTA DE PRECIOS

Precios sin IVA.

Válidos a partir del 1 de febrero de 2019.

PAGOS

El incumplimiento del vencimiento del pago puede provocar la retención de nuevos pedidos hasta la cancelación del impago y la tramitación legal automática a través de nuestras empresas de cobro.

Anticipado 2%

GARANTÍA

2-5 años para todos los productos Rocada en condiciones de uso normales.

Rocada se compromete a entregar un producto de calidad conforme con las especificaciones requeridas.

PLAZOS DE ENTREGA

Máximo 7 días laborables para pedidos diarios.

TRANSPORTE

Portes para Península:

Pedido neto hasta 50 €: cargo de 10 € en concepto de portes.

A partir de 50 € hasta 150 €: 5 € en concepto de portes.

A partir de 150 €: portes pagados.

Portes para Canarias, Ceuta y Melilla: 800 €. El servicio de entrega de la mercancía solo se realizará hasta la puerta de la calle. Si es necesario entregar el material dentro de su destinación, la entrega tendrá un coste extra de +8% sobre PVP.

INCIDENCIAS Y DEVOLUCIONES

Avisar dentro de las 24 horas de la recepción de la mercancía para incidencias con el transporte. No se aceptarán incidencias pasadas las 24h desde la recepción. Y nunca se aceptaran devoluciones, sin previa confirmación desde Rocada.

JURISDICCIÓN

Para cuestión que pueda derivarse de la interpretación o aplicación de estas normas el cliente y Rocada se someten expresamente a la jurisdicción y fuero de los Juzgados y Tribunales de la ciudad de Barcelona, con renuncia a cualquier otro si lo hubiere.

ORDERS

All orders shall be received in writing.

PAYMENTS

All payments should be received on or before the due date indicated on the invoice. All customers shall be covered by CESCE insurance company. Rocada is forced to communicate any delay or nonpayment. Rocada is keen to offer an extra discount of -2% for in advance payments (before loading).

GUARANTEE

All Rocada products have between 2 and 5 years guarantee.

DELIVERY LEADTIME

Between 10-15 working days for stock orders. We shall inform the approximate delivery time once the order has been placed.

Each delivery shall be deemed a separate transaction and the failure of any one delivery shall not affect the due performance of the order. Any request to vary the quantity or delivery date of an order must be notified in writing. Ex-works prices.

CLAIMS - RETURN

All claims for damage to goods or partial loss of goods in transit must be submitted to, and received by us within 2 days of delivery.

No goods can be returned without prior notification and an official pick up note produced by us.

JURISDICTION

Spanish law only shall apply to this contract and all disputes shall be dealt with by the Spanish courts alone.

MODIFICACIONES / MODIFICATIONS

[ESP] Esta tarifa anula las anteriores. Nos reservamos el derecho de modificar sin previo aviso características, formas y medidas de nuestros productos. Tarifa válida excepto error tipográfico.

[ENG] This pricelist annuls all the previous ones. We reserve the right to change product specifications, sizes or colors without prior notice. Errors, omissions excluded.



Rocada Spain
rocada@rocada.com
www.rocada.com

Rocada Deutschland GmbH
info@rocada.de
www.rocada.de

Distribuido por / Distributed by:



rocada



Natural

La perfección de todas las cosas naturales

The perfection of all things natural

Die Perfektion aller Dinge natürlich

La perfection de tout ce qui est naturel



ESP. Formas inspiradas en la naturaleza. La colección NATURAL es el resultado de nuestros años de experiencia. Éstas son nuestras raíces. Simplicidad y equilibrio.

ENG. Shapes inspired by nature. The NATURAL collection comes as a result of years of experience. These are our roots. Simplicity and Balance.

DE. Formen von der Natur inspiriert. Die NATURAL Kollektion ist das Ergebnis jahrelanger Erfahrung. Das sind unsere Wurzeln. Einfachheit und Ausgeglichenheit.

FR. Formes inspirées par la nature. La collection NATURAL est le fruit de nombreuses années d'expérience. Ce sont nos racines. Simplicité et équilibre.



Natural



COLECCIÓN NATURAL
NATURAL COLLECTION
NATÜRLICHE SAMMLUNG
COLLECTION NATURELLE

10 / 11
NAT0610



12 / 13
NAT8100



06 / 09
NAT0616
NAT0618





16 / 19
NAT6420 75x115cm
NAT6421 100x150cm

24 / 26
NAT3100

20 / 23
NAT6871

14 / 15
NAT0705
NAT0706







◀ NAT0616
NAT0618

ESP. Pizarra móvil con un soporte sólido que combina acabados metálicos y de madera.

ENG. Mobile flipchart with a solid stand combining metallic and wood finishes.

DE. Mobiles Flipchart mit stabilem Ständer, der Metallic- und Holzoberflächen kombiniert.

FR. Tableau à feuilles mobiles avec un support solide combinant des finitions métalliques et du bois.

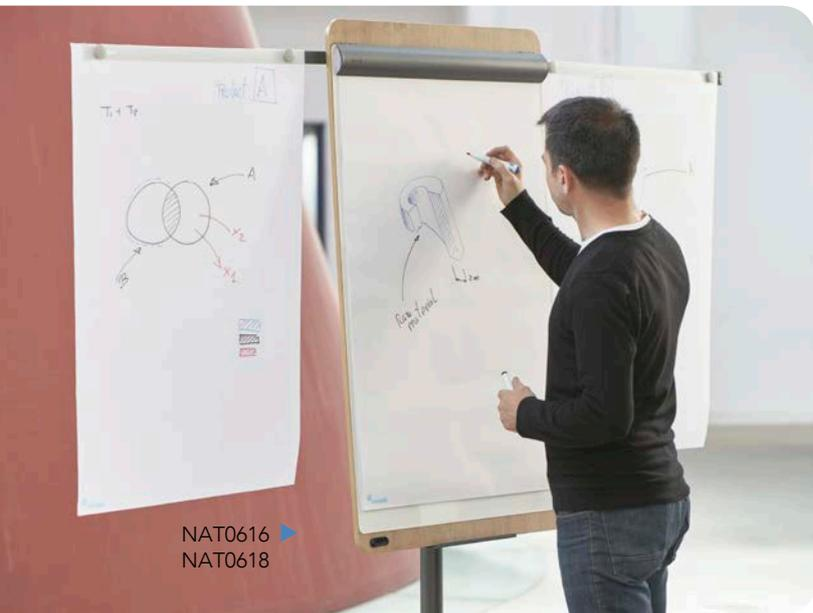

NAT0616
NAT0618

ESP. Pizarra móvil apta para escritura con rotuladores de borrado en seco. Regulable en altura para ajustarse a la altura de cada usuario, brazos abatibles de serie y con un sistema de rotación patentado único en el mercado que permite convertir la pizarra en mesa.

ENG. Mobile board suitable for writing with dry erase markers. Adjustable in height to adjust to the height of each user, folding arms as standard, and with a patented rotation system and unique in the market that allows converting the board into a table.

DE. Mobile Tafel zum Beschreiben mit Dry-Erase-Markern. Höhenverstellbar zur Anpassung an die Körpergröße jedes Benutzers, standardmäßig mit Gelenkarmen und einem patentierten Rotationssystem, das es ermöglicht, das Board in einen Tisch umzuwandeln.



FR. Tableau mobile adapté pour écrire avec des marqueurs effaçables à sec. Réglable en hauteur pour s'adapter à la taille de chaque utilisateur, bras repliables en standard et système de rotation breveté et unique sur le marché qui permet de convertir la planche en table.



◀ NAT0618



ESP. Pizarra trípode con estructura metálica que resalta los acabados de madera.

ENG. *Tripod flipchart with a metallic structure that highlights the wood finishes.*

DE. Stativ-Flipchart mit einer Metallstruktur, die die Holzoberflächen hervorhebt.

FR. *Tableau de conférence tripode avec une structure métallique qui met en valeur les finitions en bois.*





NAT8100 ▶

ESP. Pizarras móviles que permiten escribir en ambos lados. Los acabados de madera son la expresión de su poder.

ENG. Mobile whiteboard that allows for writing on both sides. The wood finishes are an expression of its power.

DE. Mobiles Whiteboard, das beidseitiges Schreiben ermöglicht. Die Holzoberflächen sind Ausdruck seiner Kraft.

FR. Tableau blanc mobile permettant d'écrire des deux côtés. Les finitions en bois sont une expression de sa puissance.





ESP. A veces la presentación es lo que más importa. Expositores con un alma fuerte para expresar las ideas más delicadas.

ENG. Sometimes the presentation is what matters the most. Displays with a strong soul to express the most delicate.

DE. Manchmal ist die Präsentation das Wichtigste. Displays mit einer starken Seele, um die zartesten auszudrücken.

FR. Parfois, la présentation est ce qui compte le plus. Affiche avec une âme forte pour exprimer le plus délicat.

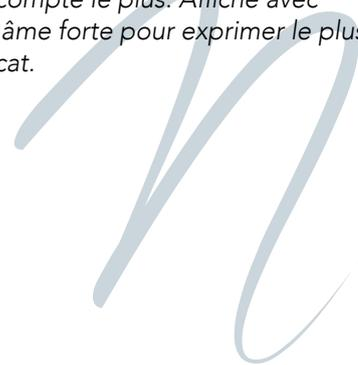



◀ NAT0706
Tamaño A3
A3 size
A3 Größe
Format A3



◀ NAT0705
Tamaño A4
A4 size
A4 Größe
Format A4

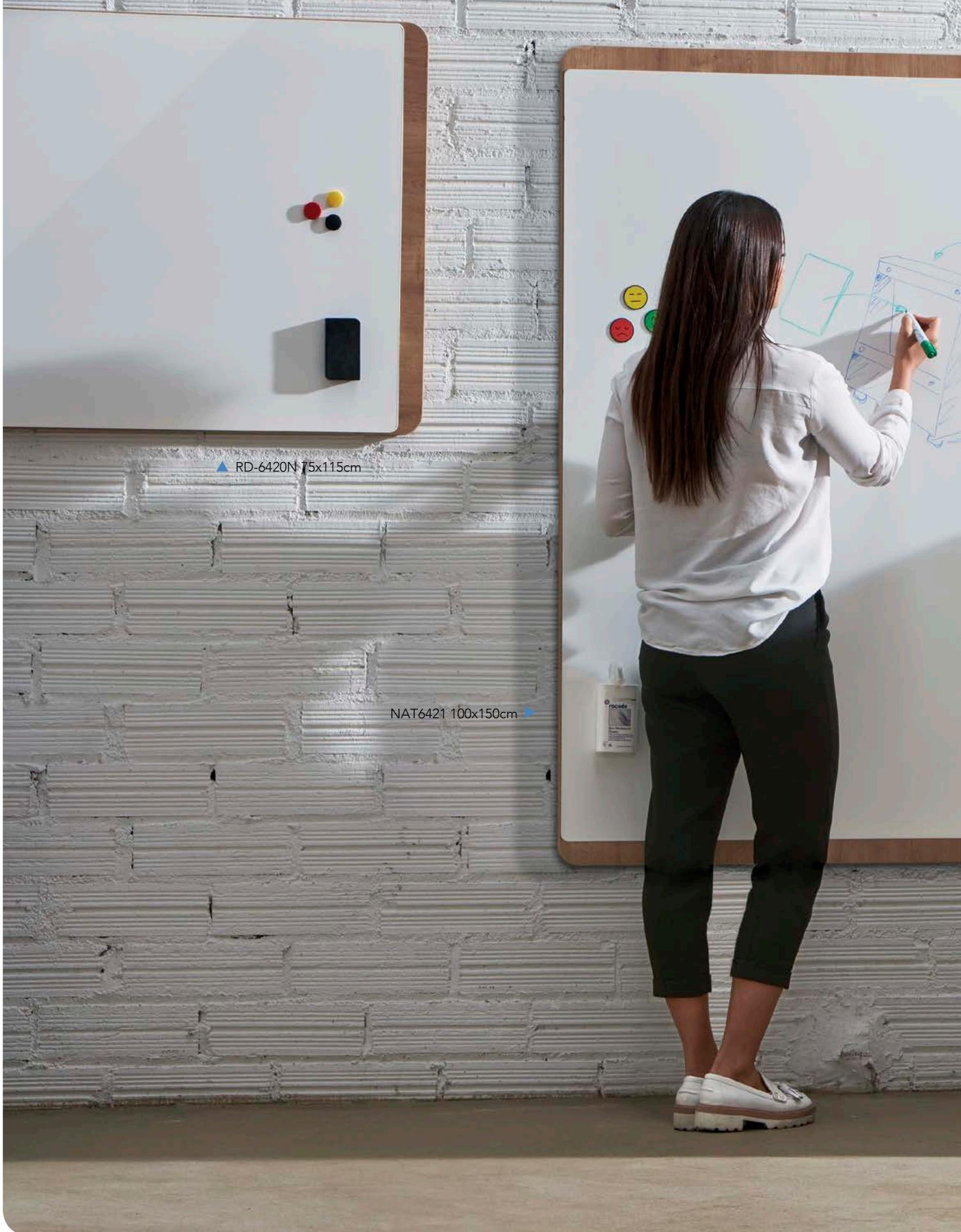

▲ RD-6420N 75x115cm

NAT6421 100x150cm ▶

ESP. Porque la información es importante. El diseño de la pizarra NATURAL permite centrarse en lo que más importa.

ENG. Because information is king. The NATURAL whiteboard's design allows for focusing on what matters the most.



DE. Weil Information König ist. Das Design des NATURAL Whiteboards ermöglicht für die Konzentration auf das, was am wichtigsten ist.

FR. Parce que l'information est roi. La conception du tableau blanc NATURAL permet pour se concentrer sur ce qui compte le plus.





NAT6420 75x115cm ▲

ESP. Pizarra de pared multifuncional con un equilibrio entre la superficie magnética y sus acabados en madera. Gracias a su diseño con fijación magnética, permite colocarlas en vertical y horizontal. Totalmente compatibles con los rotuladores de borrado en seco. Una pizarra que dará un toque más moderno, más cálido y más natural a su oficina.

ENG. Multifunctional wall slate with a balance between the magnetic surface and its wood finishes. Thanks to its magnetic fixing design, it allows to place them vertically and horizontally. Fully compatible with dry erase markers. A blackboard that will give a more modern, warmer and more natural touch to your office.

DE. Multifunktionaler Wandschiefer mit einem Gleichgewicht zwischen der magnetischen Oberfläche und den Holzoberflächen. Dank des magnetischen Befestigungsdesigns können sie vertikal und horizontal platziert werden. Voll kompatibel mit Dry Erase Markern. Eine Tafel, die Ihrem Büro eine modernere, wärmere und natürlichere Note verleiht.

FR. Ardoise murale multifonctionnelle équilibrant la surface magnétique et les finitions en bois. Grâce à son design de fixation magnétique, il permet de les placer verticalement et horizontalement. Entièrement compatible avec les marqueurs effaçables à sec. Un tableau qui donnera à votre bureau une touche plus moderne, plus chaleureuse et plus naturelle.





▲ NAT6871

Soporte + pizarra
Support + whiteboard
Unterstützung + Whiteboard
Support + tableau blanc

ESP. Expresarnos es natural. El soporte giratorio NATURAL le permite mostrar todas sus necesidades, presentaciones y sentimientos.

ENG. Expressing ourselves is natural. The NATURAL revolving support allows you to showcase all your needs, presentations and feelings.



DE. Sich auszudrücken ist natürlich. Die NATÜRLICHE Drehunterstützung ermöglicht es Ihnen, alle Ihre Bedürfnisse, Präsentationen und Gefühle zu präsentieren.

FR. S'exprimer est naturel. Le support rotatif NATURAL vous permet de mettre en valeur tous vos besoins, présentations et sentiments.

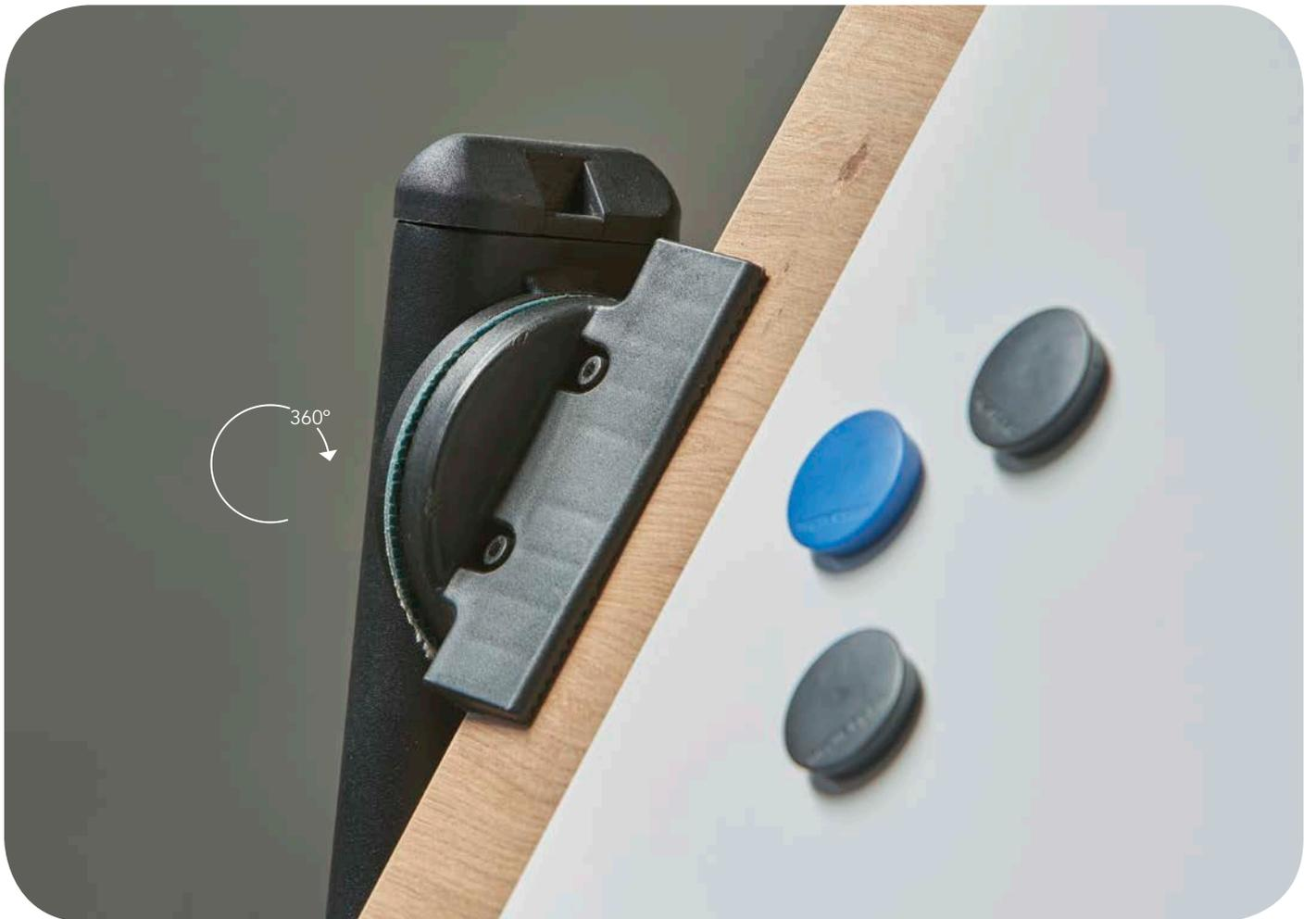

Sistema de rotación de 360° · Free rotation system 360° · 360°-Rotationssystem · Système de rotation libre à 360°



▲ NAT6871

ESP. Soporte móvil de doble cara con pizarras lacadas en ambos lados.

ENG. Mobile double-sided support with lacquered boards on both sides.

DE. Mobile doppelseitige Auflage mit beidseitig lackierten Brettern.

FR. Support mobile double face avec des panneaux laqués des deux côtés.



ESP. Soporte simple y fuerte para la gama SKINWHITEBOARD. Todo el poder de los acabados de madera se presenta en toda la gama de pizarras Skin. Deslumbrantes soluciones de comunicación.

ENG. Simple and strong support for the SKINWHITEBOARD range. All the power of wood finishes is featured throughout the skin range. Dazzling communication solutions.



NAT3100 ▲

Pizarra Skinwhiteboard no incluída.

Skinwhiteboard not included.

Tafel nicht enthalten

Tableau Skinwhiteboard non inclus.

DE. Einfache und starke Unterstützung für die SKINWHITEBOARD. Die ganze Kraft von Holzoberflächen ist in der gesamten Hautlinie zu spüren. Verblüffende Kommunikationslösungen.

FR. Support simple et puissant pour la gamme SKINWHITEBOARD. Toute la puissance des finitions en bois est présente dans toute la gamme de peaux. Des solutions de communication éblouissantes.



ESP. Admite pizarras Skin Pro y Skin Colour.

ENG. Allows to install the Skin Pro and Skin Colour whiteboards.

DE. Ermöglicht die Installation von Skin Pro und Skin Colour Whiteboards

FR. Permet d'installer des tableaux Skin Pro et Skin Color.



NAT3100 ▲



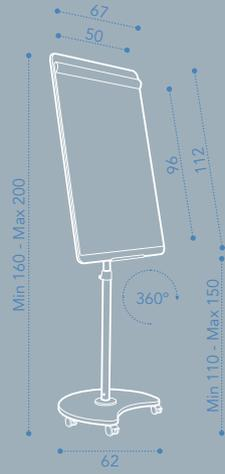

▲ NAT0618

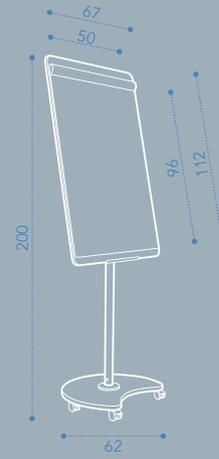

▲ NAT0616

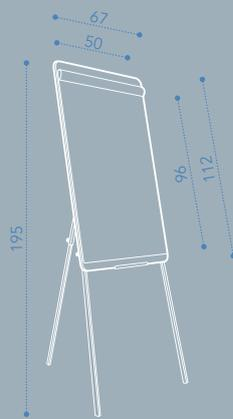

▲ NAT0610

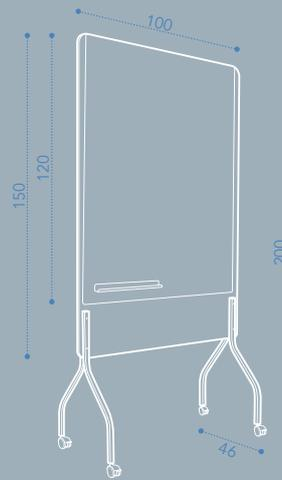

▲ NAT8100

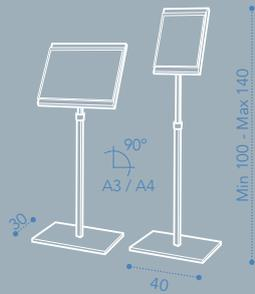

▲ NAT0706 A3 size / NAT0705 A4 size

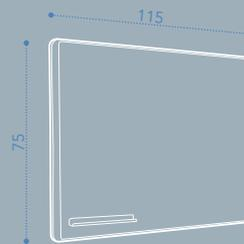

▲ NAT6420 75x115cm

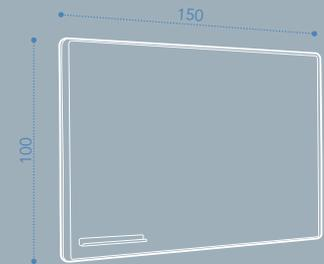

▲ NAT6421 100x150cm

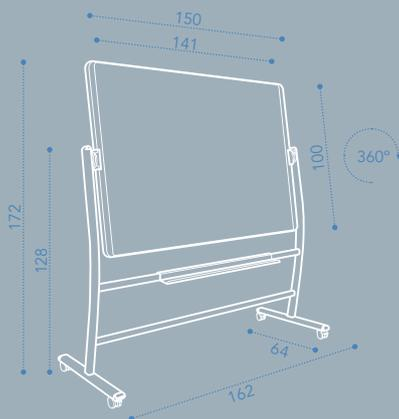

▲ NAT6871

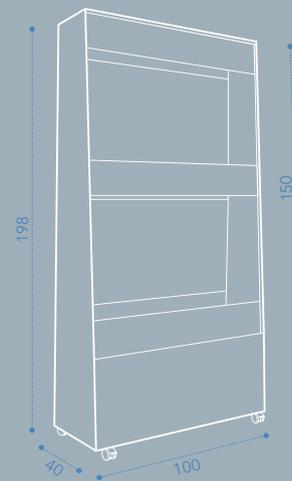

▲ NAT3100



rocada

Rocada Spain
rocada@rocada.com
www.rocada.com

Rocada Deutschland GmbH
info@rocada.de
www.rocada.de



ISO 14001

BUREAU VERITAS
Certification



© Certified
suppliers with
Forest
Stewardship
Council



Certified
suppliers with
the Programme
for the Endorsement
of Forest Certification
schemes



Distribuido por:
Distributed by:
Vertrieben von:
Distribué par:





rocada

www.rocada.com

Be Soft

UN LUGAR
DE ENCUENTRO
Y COMUNICACIÓN



ISO 14001
BUREAU VERITAS
Certification



interseroh
Transportverpackung





Be Soft

by ROCADA

El constante movimiento de la persona en todos sus estados implica una adaptación continua de los entornos públicos y empresariales para dar respuesta a las necesidades actuales de comunicación, relación, creatividad y descanso.

BE SOFT es un programa que nace para dar soluciones, facilidad y la máxima adaptación a estas necesidades actuales.

Be Soft

COLLECTION

1804 (p. 24-29)

Su sencillo diseño y estética minimalista invita a sentarse para aislarse del entorno y disfrutar sin condiciones.

1805 (p. 12-17)

Mobiliario colaborativo de alto rendimiento, mejorando la flexibilidad y el confort.



1828 (p. 30-35)

Complemento perfecto para áreas de descanso, zonas mixtas de trabajo y espacios polivalentes.

1806 (p. 18-23)

Comunicación, relación y creatividad se unen y se entremezclan para conseguir lo mejor de las relaciones humanas.

1803 (p. 6-11)

Unidades modulares diseñadas para modernizar el espacio de reunión, colaboración y comunicación.



BE SOFT MODULAR

REF: 1803

Unidades modulares diseñadas para modernizar el espacio de reunión, colaboración y comunicación, creando un entorno interactivo y productivo.







BE SOFT MODULAR

REF: 1803

Los diseños orgánicos y ergonómicos aportan una estética distintiva y adaptada a los nuevos tiempos.

Con una variedad de módulos disponibles, puede crear un espacio de trabajo adaptable para satisfacer las diversas necesidades de su equipo.



Formas simples en todos sus detalles.
Tapizados con acabados de alta calidad
y máximo confort.



Unión magnética
entre módulos.

***BAJO PEDIDO**



Tapizados con acabados de alta calidad y máximo confort. Varios colores opcionales.

Asientos tapizados en color negro.



Patas robustas de fácil instalación sin necesidad de herramientas.

UNIDADES MODULARES

Espacios personalizados, para adaptarse a sus necesidades



REF:
1803ABK



REF:
1803BBK + 1803RBK

DERECHO
Requiere
1 panel
por unidad



REF:
1803CBK + 1803MBK

CENTRAL
Requiere
1 panel
por unidad



REF:
1803DBK + 1803MBK

CENTRAL
Requiere
2 paneles
por unidad



REF:
1803EBK + 1803LBK

IZQUIERDO
Requiere
1 panel
por unidad



Paneles acústicos color gris
(REF: 1803LBK-1 / 1803MBK-1 / 1803RBK-1)



Paneles acústicos color rojo
(REF: 1803LBK-2 / 1803MBK-2 / 1803RBK-2)



Paneles acústicos color azul
(REF: 1803LBK-3 / 1803MBK-3 / 1803RBK-3)



Paneles acústicos color negro
(REF: 1803LBK-4 / 1803MBK-4 / 1803RBK-4)



Paneles acústicos color naranja
(REF: 1803LBK-5 / 1803MBK-5 / 1803RBK-5)



Paneles acústicos color verde
(REF: 1803LBK-6 / 1803MBK-6 / 1803RBK-6)

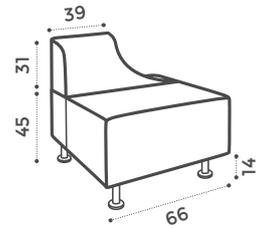
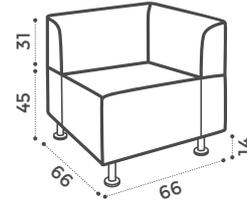
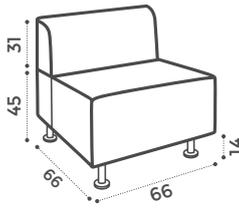
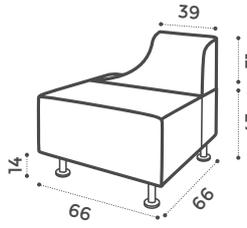
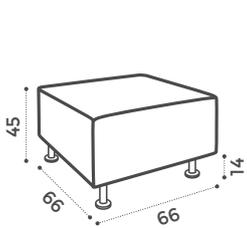

REF	1803ABK-4
COLOR	Negro
ACABADOS	Tapizado
PACKAGING (cm / kg / m3)	75 x 68 x 33 12,70 kg 0,168 m3

REF	1803BBK-4
COLOR	Negro
ACABADOS	Tapizado
PACKAGING (cm / kg / m3)	68 x 88 x 66 16,70 kg 0,395 m3

REF	1803CBK -4
COLOR	Negro
ACABADOS	Tapizado
PACKAGING (cm / kg / m3)	68 x 88 x 66 14,90 kg 0,395 m3

REF	1803DBK-4
COLOR	Negro
ACABADOS	Tapizado
PACKAGING (cm / kg / m3)	68 x 88 x 66 18,30 kg 0,395 m3

REF	1803EBK-4
COLOR	Negro
ACABADOS	Tapizado
PACKAGING (cm / kg / m3)	68 x 88 x 66 16,70 kg 0,395 m3

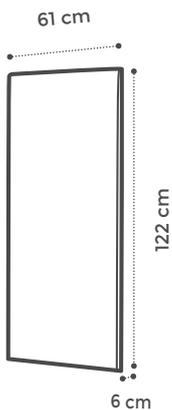

REF	IZQUIERDO	1803LBK-1	1803LBK-2	1803LBK-3	1803LBK-4	1803LBK-5	1803LBK-6
	CENTRAL	1803MBK-1	1803MBK-2	1803MBK-3	1803MBK-4	1803MBK-5	1803MBK-6
	DERECHO	1803RBK-1	1803RBK-2	1803RBK-3	1803RBK-4	1803RBK-5	1803RBK-6
COLORES	Gris	Rojo	Azul	Negro	Naranja	Verde	
ACABADOS	Tapizado	Tapizado	Tapizado	Tapizado	Tapizado	Tapizado	
PACKAGING (cm / kg / m3)	124 x 63 x 6 9,50 kg 0,046 m3	124 x 63 x 6 9,50 kg 0,046 m3	124 x 63 x 6 9,50 kg 0,046 m3	124 x 63 x 6 9,50 kg 0,046 m3	124 x 63 x 6 9,50 kg 0,046 m3	124 x 63 x 6 9,50 kg 0,046 m3	

BE SOFT DOBLE CON MESA

REF: 1805

Módulo de 2 asientos combinado con la pequeña mesa de trabajo, permitiendo conseguir espacios y ambientes distendidos y agradables, donde la comunicación fluye sin obstáculos.

Es la creación de espacios más adaptados a las nuevas tendencias de relación humana.







BE SOFT DOBLE CON MESA

REF: 1805

Diseñado para un trabajo profundo a través de la privacidad. Construido con elementos acústicos que proporcionan el ambiente ideal para el trabajo híbrido moderno.

El tablero de la mesa viene acabado en melamina de color roble de alta calidad.



Privacidad para sentirse como en casa.



Módulos equipados con conexión eléctrica.



Montaje e instalación sin herramientas.

*BAJO PEDIDO



Tapizados con acabados de alta calidad y máximo confort. Varios colores opcionales.



Asientos tapizados en color negro.

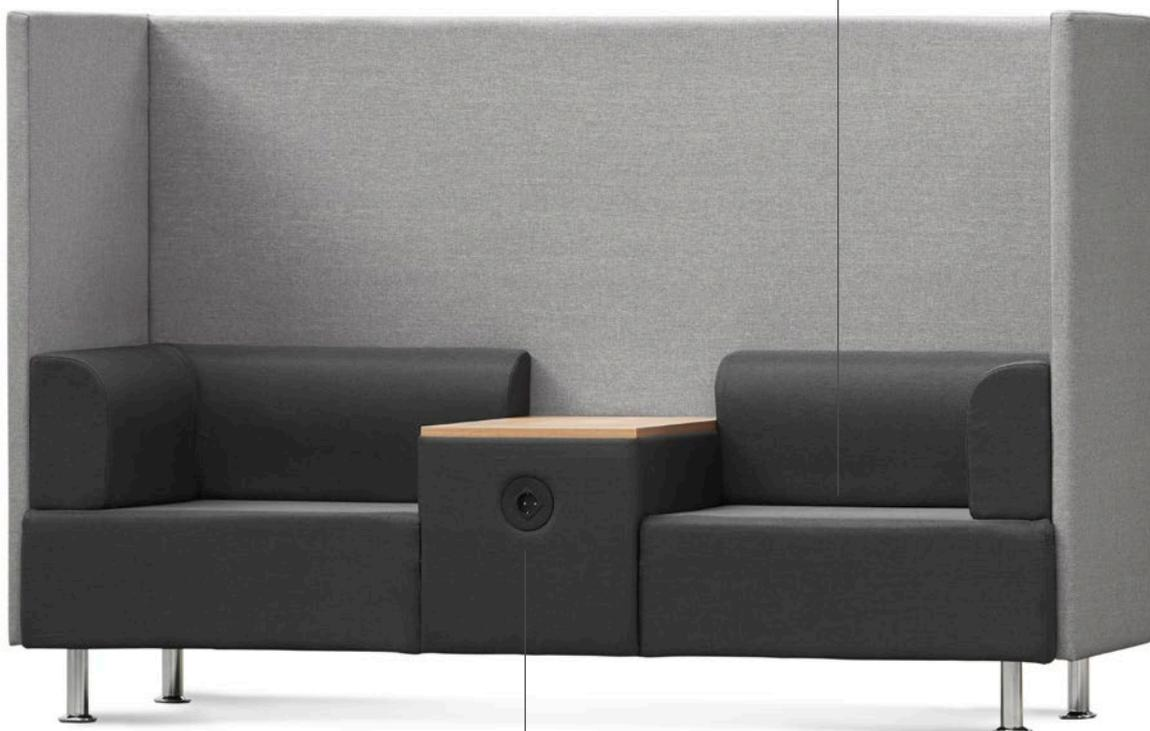

Módulos equipados con conexión eléctrica.

Patas robustas de fácil instalación sin necesidad de herramientas.



Superficie de melamina con acabado color roble.





Be soft doble color gris
(REF: 1805-4-1)



Be soft doble color rojo
(REF: 1805-4-2)



Be soft doble color azul
(REF: 1805-4-3)



Be soft doble color negro
(REF: 1805-4-4)



Be soft doble color naranja
(REF: 1805-4-5)



Be soft doble color verde
(REF: 1805-4-6)

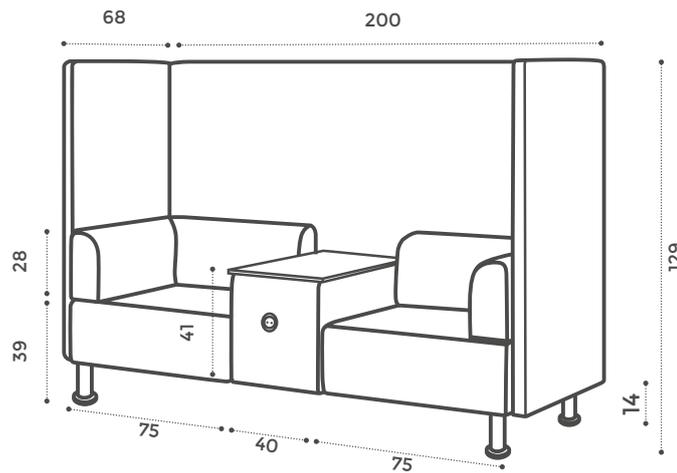

***BAJO PEDIDO**



REF	1805-4-1	1805-4-2	1805-4-3	1805-4-4	1805-4-5	1805-4-6
COLORES	Gris	Rojo	Azul	Negro	Naranja	Verde
ACABADOS	Tapizado	Tapizado	Tapizado	Tapizado	Tapizado	Tapizado
PACKAGING (cm / kg / m3)	194 x 72 x 58 195 x 119 x 13 95.40 kg 1.112 m3	194 x 72 x 58 195 x 119 x 13 95.40 kg 1.112 m3	194 x 72 x 58 195 x 119 x 13 95.40 kg 1.112 m3	194 x 72 x 58 195 x 119 x 13 95.40 kg 1.112 m3	194 x 72 x 58 195 x 119 x 13 95.40 kg 1.112 m3	194 x 72 x 58 195 x 119 x 13 95.40 kg 1.112 m3

BE SOFT INDIVIDUAL CON MESA

REF: 1806

Módulo de 1 asiento combinado con la pequeña mesa de trabajo que permite conseguir un espacio personal con la máxima comodidad y ergonomía para sus tareas. Entornos que conviven dentro de espacios donde las relaciones humanas se hacen presentes de distinta manera.

Comunicación, relación y creatividad se unen y se entremezclan para conseguir lo mejor de las relaciones humanas.





BE SOFT INDIVIDUAL CON MESA

REF: 1806

Módulo ideal para potenciar cualquier ambiente de trabajo aportando la calidez y la privacidad necesaria para optimizar las diferentes necesidades de trabajo personal.



Privacidad para sentirse como en casa.



Módulos equipados con conexión eléctrica.



Montaje e instalación sin herramientas.

BE SOFT INDIVIDUAL CON MESA

*BAJO PEDIDO



Tapizados con acabados de alta calidad y máximo confort. Varios colores opcionales.



Asiento tapizado en color negro.



Módulos equipados con conexión eléctrica.

Patas robustas de fácil instalación sin necesidad de herramientas.



Superficie de melamina con acabado color roble.





Be soft individual color gris
(REF: 1806-4-1)



Be soft individual color rojo
(REF: 1806-4-2)



Be soft individual color azul
(REF: 1806-4-3)



Be soft individual color negro
(REF: 1806-4-4)



Be soft individual color naranja
(REF: 1806-4-5)



Be soft individual color verde
(REF: 1806-4-6)

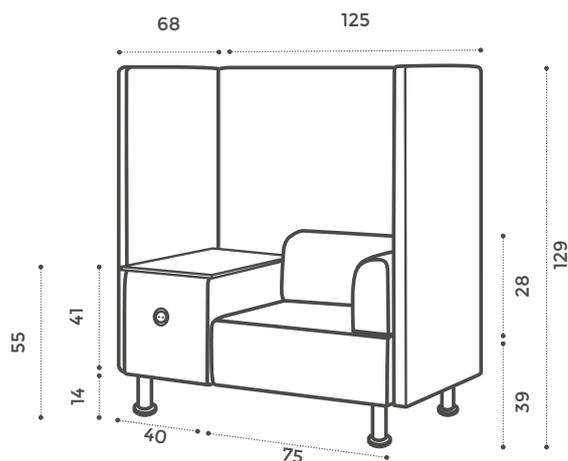

***BAJO PEDIDO**



REF	1806-4-1	1806-4-2	1806-4-3	1806-4-4	1806-4-5	1806-4-6
COLORES	Gris	Rojo	Azul	Negro	Naranja	Verde
ACABADOS	Tapizado	Tapizado	Tapizado	Tapizado	Tapizado	Tapizado
PACKAGING (cm / kg / m3)	120 x 72 x 60 144 x 119 x 13 68.60 kg 0.748 m3	120 x 72 x 60 144 x 119 x 13 68.60 kg 0.748 m3	120 x 72 x 60 144 x 119 x 13 68.60 kg 0.748 m3	120 x 72 x 60 144 x 119 x 13 68.60 kg 0.748 m3	120 x 72 x 60 144 x 119 x 13 68.60 kg 0.748 m3	120 x 72 x 60 144 x 119 x 13 68.60 kg 0.748 m3

BE SOFT INDIVIDUAL SIN MESA

REF: 1804

Módulo individual, directo y personal donde el usuario consigue su protagonismo y le permite relajarse, sentirse cómodo y activar su creatividad.

Su sencillo diseño y estética minimalista invita a sentarse para aislarse del entorno y disfrutar sin condiciones.





BE SOFT INDIVIDUAL SIN MESA

REF: 1804

Diseñado para evitar cualquier distracción. Con una sólida estructura de madera de pino junto a una estructura secundaria de acero, confieren a este producto una solidez y una comodidad máxima.

Diseño de líneas simples y directas para una adaptación total.



Privacidad para sentirse como en casa.



Formas con un carácter claramente marcado. Acabados metálicos color gris.



Cojín adaptable para una comodidad óptima.

BE SOFT INDIVIDUAL SIN MESA

*BAJO PEDIDO



Tapizados con acabados de alta calidad y máximo confort. Varios colores opcionales.



Asiento tapizado en color negro.

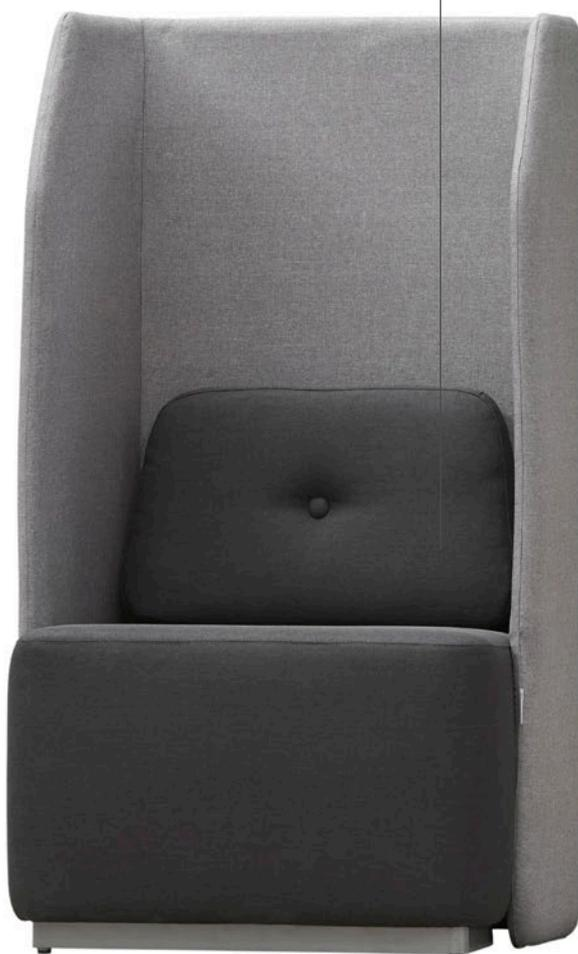

Estructura robusta con embellecedor metálico.





Be soft individual color gris
(REF: 1804-4-1)



Be soft individual color rojo
(REF: 1804-4-2)



Be soft individual color azul
(REF: 1804-4-3)



Be soft individual color negro
(REF: 1804-4-4)



Be soft individual color naranja
(REF: 1804-4-5)



Be soft individual color verde
(REF: 1804-4-6)

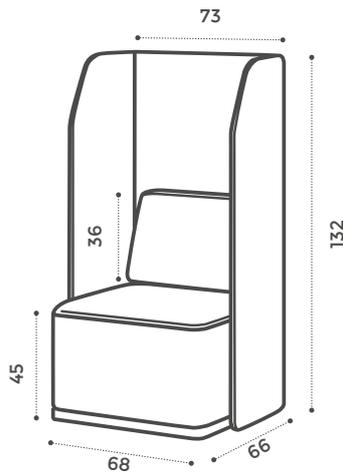

***BAJO PEDIDO**



REF	1804-4-1	1804-4-2	1804-4-3	1804-4-4	1804-4-5	1804-4-6
COLORES	Gris	Rojo	Azul	Negro	Naranja	Verde
ACABADOS	Tapizado	Tapizado	Tapizado	Tapizado	Tapizado	Tapizado
PACKAGING (cm / kg / m3)	137 x 77 x 70 36.50 kg 0.738 m3	137 x 77 x 70 36.50 kg 0.738 m3	137 x 77 x 70 36.50 kg 0.738 m3	137 x 77 x 70 36.50 kg 0.738 m3	137 x 77 x 70 36.50 kg 0.738 m3	137 x 77 x 70 36.50 kg 0.738 m3

TABURETE BE SOFT

REF: 1828

Un taburete ajustable en altura con un diseño fresco y contemporáneo.

Complemento perfecto para áreas de descanso, zonas mixtas de trabajo y espacios polivalentes, donde el confort y la estética se dan la mano.





BE SOFT STOOL

REF: 1828

Distensión, dinamismo y comunicación son aspectos que complementarán y mejorarán su ergonomía y potenciarán la creatividad en sus espacios, tanto en los entornos de trabajo, como en sus áreas de desconexión y descanso.



Su regulación en altura y su balanceo permiten un uso adecuado y una adaptación máxima en cada momento.

Carcasa ergonómica disponible en gris y blanco.



Asiento con tapizado negro. Acabados de alta calidad y máximo confort.



Estructura de polímero técnico con forma hexagonal. Disponible en gris y blanco.



Sistema de regulación con mecanismo de activación.





Taburete Be soft color gris
(REF: 1828-4-1)



Taburete Be soft color blanco
(REF: 1828W-4-1)

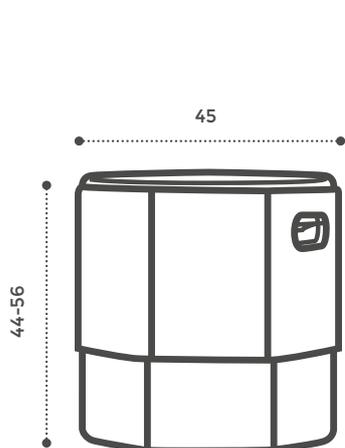

REF	1828-4-1	1828W-4-1
COLORES	Gris	Blanco
ACABADOS	Tapizado	Tapizado
PACKAGING (cm / kg / m3)	46 x 46 x 45 11,30 kg 0,095 m3	46 x 46 x 45 11,30 kg 0,095 m3



ISO 9001:2015

La calidad y fiabilidad de nuestros procesos de producción están avalados por la certificación ISO 9001:2015



ISO 14001:2015

Respetar y proteger el medioambiente es prioritario en nuestros procesos productivos. El uso de productos reciclados y la utilización razonable de los recursos son prioridades inexcusables.



INTERSEROH

Servicios ambientales con un enfoque integrado para cerrar los bucles de los productos, soluciones de reciclaje y estrategias de prevención de residuos que establecen estándares en toda la industria.



FSC / PEFC

Proveedores certificados por la organización internacional, creada el año 1993 para promover la gestión responsable de los bosques de todo el mundo.



rocada

Rocada HQ (Spain)
rocada@rocada.com
www.rocada.com

Rocada Deutschland GmbH
info@rocada.de
www.rocada.de

Rocada Japan LLC
info@rocada.co.jp



ISO 14001

BUREAU VERITAS
Certification



© Certified
suppliers with
**Forest
Stewardship
Council**



Certified
suppliers with
the **Programme
for the Endorsement
of Forest Certification
schemes**



interseroh
Transportverpackung



rocada

www.rocada.com



HOME OFFICE

by ROCADA



ISO 14001
BUREAU VERITAS
Certification



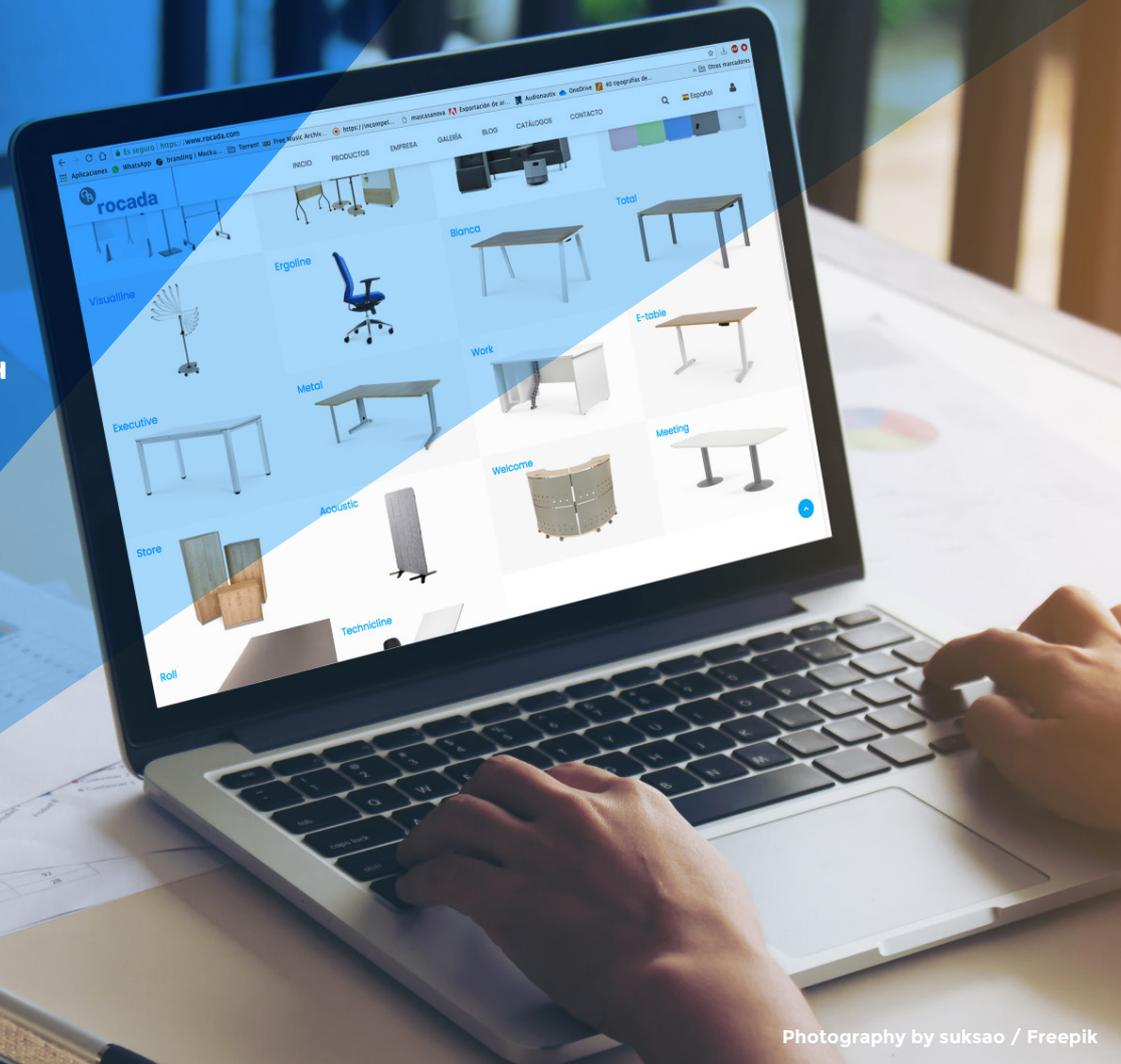

Photography by suksao / Freepik

HOME OFFICE

El llamado home office, o también conocido como teletrabajo, se basa en la flexibilidad de las empresas a la hora de establecer horarios y determinar los espacios de trabajo.

Este 2020, con la pandemia que estamos afrontando, ha pasado de ser una modalidad de trabajo minoritaria, a ser una modalidad adoptada por casi todas las compañías. La posibilidad de trabajar en casa, es una tendencia que aporta múltiples beneficios tanto para las empresas como para los profesionales.

Para las empresas; el home office se traduce en mayor productividad, la eliminación del absentismo laboral, la reducción de costes y el ahorro en el mantenimiento de infraestructuras innecesarias. Y paralelamente, por parte de los trabajadores; se incrementa la autonomía. Las personas pueden encauzar los flujos de trabajo según el horario que les apetezca o les permita conciliar la vida laboral con el cuidado de la familia, evitando, a la vez, gastos en canguros y cuidadores, comidas fuera de casa y

costes de desplazamiento en transporte público o vehículo privado. Generalmente, todas estas ventajas repercuten en un aumento de la satisfacción de los empleados, reforzando su compromiso con la empresa, y a largo plazo, en el incremento de su productividad.

Así pues, cada vez es más evidente que se trata de una modalidad de trabajo altamente eficiente, en especial en las áreas de ventas, marketing, desarrollo de software o gestión del big data.

Sin embargo, para sacar el máximo provecho de esta dinámica laboral es necesario optimizar tu nuevo puesto de trabajo para mantener todas las prestaciones y comodidades de la oficina en casa.

A continuación presentamos las siguientes propuestas de ROCADA. Para cualquier duda, por favor contacta con nosotros. Estaremos encantados de ayudarte a encontrar los productos más adecuados para su Home Office by ROCADA.



CALIDAD Y FIABILIDAD

La calidad y fiabilidad de nuestros procesos de producción están avalados por la certificación ISO 9001:2015



MEDIOAMBIENTE

Respetar y proteger el medioambiente es prioritario en nuestros procesos productivos. El uso de productos reciclados y la utilización razonable de los recursos son prioridades inexcusables.



INTERSEROH

Servicios ambientales con un enfoque integrado para cerrar los bucles de los productos, soluciones de reciclaje y estrategias de prevención de residuos que establecen estándares en toda la industria.

HOME OFFICE

by ROCADA



MESAS

Mesas de diseño funcional que permiten la adaptación a cualquier zona de trabajo, ofreciendo el máximo confort.



ACCESORIOS PARA MESAS

Conjunto de accesorios compatibles con toda la gama de mesas, permitiendo la optimización del espacio y generando más comodidad.

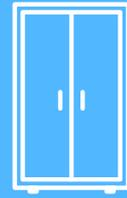

ARMARIOS Y COMPLEMENTOS

Amplia gama de armarios y complementos para la óptima gestión del espacio de trabajo y organización diaria.



SILLAS

Amplia gama de sillas operativas que ofrecen la máxima comodidad al usuario, durante la jornada laboral.



PRODUCTOS AUXILIARES

Mobiliario ergonómico y multifuncional, diseñado para optimizar y sacar el máximo provecho a tu lugar de trabajo.



PIZZARRAS

Múltiples opciones para mejorar la planificación durante la jornada laboral, aportando diseño a tu espacio de trabajo.



MESAS

SMART - MESA PLEGABLE DE PARED



Disponemos de una gran variedad de pizarras, complemento perfecto para la mesa plegable. Para más información consultar todas las opciones de medidas y colores de nuestras pizarras NATURAL y SKINWHITEBOARD.



Mesa plegable de nuestra gama de mesas **"SMART"**, con superficie de melamina de 19mm y sistema de fijación a pared con sistema de plegado de fácil activación. Sistema perfecto para aprovechar cualquier espacio de casa por pequeño que sea. Diseñada para complementar con nuestras pizarras de la gama **NATURAL** y **SKINWHITEBOARD** (pizarra no incluida en el precio).



Ref: 1997FG
(115 x 60 cm)

ESTRUCTURA:



SUPERFICIES DE MELAMINA:

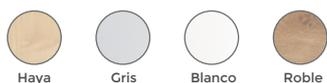



**SMART - MESA
MÓVIL "TOCO"**



Disponemos de una gran variedad de pizarras, complemento perfecto para la mesa móvil "TOCO". Para más información consultar todas las opciones de medidas y colores de nuestras pizarras NATURAL y SKINWHITEBOARD.



Mesa móvil de nuestra nueva gama de mesas **"SMART"**, diseñada y pensada para la adaptación del trabajo en casa.

La elección perfecta para adaptarse a cualquier espacio. Fabricado en tubo cilíndrico de acero de 35 mm y superficie de melamina de 19 mm. Su segundo nivel ofrece un espacio auxiliar para poder disponer de una superficie más limpia en su área de trabajo, con 2 posiciones para ajustarse a sus necesidades.



ESTRUCTURA:



Blanco

SUPERFICIE DE MELAMINA:



Blanco



MESAS

E-TABLE

Mesa con estructura en acero, regulable en altura mediante mecanismo eléctrico, de diseño vanguardista. Superficie de melamínico sobre aglomerado de 25mm de grosor con canto de PVC de 2mm. Incorpora niveladores de regulación en altura de 2cm. Recomendada para los trabajos más exigentes.

ESTRUCTURA:



Blanco

SUPERFICIES DE MELAMINA:



Haya



Gris



Blanco



Roble



Ref: 2002XCR
(160 x 80 cm)

BLANCA

Mesa con estructura tubular de acero de 30x30mm de diseño selecto y pies inclinados de 70x30mm. Superficie de melamínico sobre aglomerado de 25mm de grosor con canto de PVC de 2mm. Incorpora niveladores de regulación en altura de 2cm.

ESTRUCTURA:



Gris



Blanco



Antracita



Cromado

SUPERFICIES DE MELAMINA:



Haya



Gris



Blanco



Roble

SUPERFICIES DE CRISTAL:



Translúcido



Blanco



Negro



Ref:
2000MID / MIM / MIY / MIE - (120 x 60 cm)
2001MID / MIM / MIY / MIE - (140 x 80 cm)
2002MID / MIM / MIY / MIE - (160 x 80 cm)

TOTAL

Mesa con estructura en tubo de acero de 30x30mm de diseño minimalista y pies rectos de 70x30mm. Superficie de melamínico sobre aglomerado de 25mm de grosor con canto de PVC de 2mm. Incorpora niveladores de regulación en altura de 2cm.

ESTRUCTURA:



Gris



Blanco



Antracita



Cromado

SUPERFICIES DE MELAMINA:



Haya



Gris



Blanco



Roble

SUPERFICIES DE CRISTAL:



Translúcido



Blanco



Negro



Ref:
2000MD / MM / MY / ME - (120 x 60 cm)
2001MD / MM / MY / ME - (140 x 80 cm)
2002MD / MM / MY / ME - (160 x 80 cm)



EXECUTIVE

Mesa con estructura en tubo de acero de 40x30mm de diseño compacto y pies rectos de 60x60mm. Superficie de melamínico sobre aglomerado de 25mm de grosor con canto de PVC de 2mm. Incorpora niveladores de regulación en altura de 5cm.

ESTRUCTURA:



SUPERFICIES DE MELAMINA:

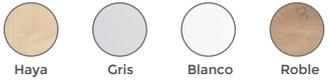

SUPERFICIES DE CRISTAL:



Ref:
2000AD / AM / AY / AE - (120 x 60 cm)
2006AD / AM / AY / AE - (140 x 80 cm)
2001AD / AM / AY / AE - (160 x 80 cm)

METAL

Mesa con estructura de diseño elegante y pies de acero con sistema de pasacables incorporado. Superficie de melamínico sobre aglomerado de 25mm de grosor con canto de PVC de 2mm. Incorpora niveladores de regulación en altura de 5cm.

ESTRUCTURA:



SUPERFICIES DE MELAMINA:



Ref:
2000AC / ACW / ACY - (120 x 60 cm)
2001AC / ACW / ACY - (140 x 80 cm)
2002AC / ACW / ACY - (160 x 80 cm)

WORK

Mesa con estructura de diseño sólida. Pies, estructura y top de melamínico sobre aglomerado de 25mm de grosor con canto de PVC de 2mm. Incorpora niveladores de regulación en altura de 5cm.

ESTRUCTURA DE MELAMINA:

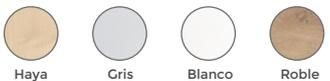

SUPERFICIES Y FALDONES DE MELAMINA:

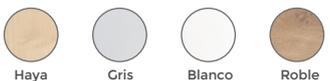

Ref:
2000AA / AB / AW / AR - (120 x 60 cm)
2001AA / AB / AW / AR - (140 x 80 cm)
2002AA / AB / AW / AR - (160 x 80 cm)



ACCESORIOS PARA MESAS

SOPORTES CPU PARA MESAS

Accesorio para torres de ordenador. Las aperturas permiten una correcta conexión de los cables y una óptima ventilación. La Ref. 2944 es compatible para mesas METAL, y ref. 2943 es compatible con mesas E-TABLE, BLANCA, TOTAL, EXECUTIVE y WORK.

DISPONIBLE EN:



Gris



Blanco



Antracita



Plata*



Ref. 2944
(20-25 x 40 x 36 cm)



Ref. 2943
(25 x 55 x 45 cm)
*Disponible en color plata

SOPORTE PARA TECLADO Y RATÓN DE ORDENADOR

Soporte deslizante. Anclajes metálicos, superficie de trabajo en melamina y reposamuñecas ergonómico para el máximo confort. Compatible con todas las mesas con superficie de melamina.



Ref. 2017
(74 x 8 x 32-52 cm)

ESTRUCTURA:



Haya

DISPONIBLE EN:



Gris



Sistema de bloqueo para una mayor seguridad en su desplazamiento.

ELECTRIFICACIÓN

Pasacables flexible en formato de columna adaptable a cualquier superficie. Compatible con nuestras mesas BLANCA, TOTAL, EXECUTIVE, METAL y WORK.

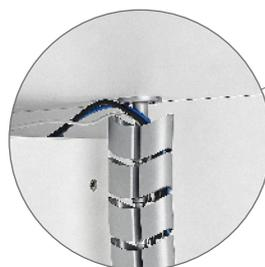

Ref. 2901
(máximo 100 cm de alto)



DISPONIBLE EN:



Gris aluminio



PASACABLES

Estructura metálica diseñada para mejorar la disposición del cableado. Compatible con todas nuestras mesas con superficies de cristal y superficies de melamina. 2 medidas a elegir.

DISPONIBLE EN:



Ref: 2921
(49 x 6 x 10 cm)

SOPORTE MÓVIL CPU

Soporte ergonómico con ruedas para CPU. Ajustable en anchura desde 17 cm a 25 cm. Equipada con 4 ruedas giratorias para su movimiento completo y ágil.

Ref: 2004
(17-25 x 24 x 34 cm)



DISPONIBLE EN:



Negro

PAPELERA 20 LITROS

Papeleras con pedal de obertura redondas de acero inoxidable, fabricada con chapa laminada 18/0 grado A. Incluye cubierta interior de polipropileno negro inyectado, tapa superior de cierre perimetral sobre cubierta interior completamente inerte ante productos de uso cotidiano e incluso de agentes químicos agresivos. Capacidad, 20l. Para otras medidas consultar.

DISPONIBLE EN:



Inox

Ref: COV-BIN20
(29 x 44 x 29 cm)





ARMARIOS Y COMPLEMENTOS

ARMARIOS, ARCHIVADORES Y BUCKS METÁLICOS

Productos fabricados en acero con cerradura incorporada y gran variedad de colores y medidas a escoger, acorde su estilo y necesidades en su nuevo espacio de trabajo.

DISPONIBLE EN:



Ref: 1650AC
(47 x 72 x 63 cm)

Ref: 1500AC
(80 x 70 x 45 cm)



Ref: 4054AC
(43 x 58 x 53 cm)

ARMARIOS COLUMNA Y BUCKS DE MELAMINA

Productos fabricados en melamina con gran variedad de colores y medidas a escoger, acorde su estilo y necesidades en su nuevo espacio de trabajo.

COLOR ESTRUCTURA:



TAPA SUPERIOR (ARMARIOS)

CAJONES (BUCKS):



Ref: 1007
(45 x 78 x 45 cm)

Ref: 4003
(40 x 58 x 60 cm)



CORTINAS ENROLLABLES

Cortinas enrollables translúcidas de gran calidad, con núcleo de 43mm de aluminio, mecanismo reversible, cadena con opción de instalación a derecha o izquierda. Tejido realizado en poliéster 30% y PVC 70%. Su amplia gama de medidas, tejidos y acabados del mecanismo permiten una adaptación total a cualquier espacio de tu casa.

COLOR TELA IGNÍFUGA:

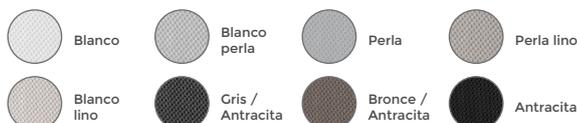

COLOR DEL MECANISMO



Ref: 4003
(40 x 58 x 60 cm)



Ref: ROLL10-14
(100 x 140 cm)

Nota informativa: por defecto, la cadena viene instalada a la derecha. En caso que se prefiera la instalación de la cadena a la izquierda se debe especificar en la hoja del pedido.

SILLAS



RD986

Silla de dirección tapizada en símil piel con base metálica cromada. Incluidos, brazos metálicos cromados y ruedas de parquet.



SIMIL PIEL:



Negro

RD937

Silla operativa profesional con asiento tapizado en tela ignífuga y respaldo en malla negra. Brazos incluidos.

*Reposacabezas no incluido



TAPIZADOS:



Gris Rojo Azul Negro Naranja Verde

RD908

Silla operativa con asiento tapizado en tela ignífuga y respaldo ergonómico en malla negra. Brazos incluidos.

*Reposacabezas no incluido



TAPIZADOS:



Gris Rojo Azul Negro Naranja Verde

RD908W

Silla operativa, acabados en blanco, con asiento tapizado en tela ignífuga y respaldo ergonómico en malla negra. Brazos incluidos.

*Reposacabezas no incluido



TAPIZADOS:



Gris Rojo Azul Negro Naranja Verde

RD907

Silla operativa, con asiento tapizado en tela ignífuga y respaldo confort en malla negra. Brazos incluidos.



TAPIZADOS:



Gris Rojo Azul Negro Naranja Verde

RD930 / 930+956

Silla operativa, con asiento y respaldo tapizado en tela y base de polímero técnico. Brazos incluidos, según modelo.



TAPIZADOS:



Gris Rojo Azul Negro

1828-4-1

Taburete regulable en altura de diseño innovador. Perfecto para áreas mixtas de relax y trabajo, donde el confort y la estética se dan la mano.



TAPIZADO: ESTRUCTURA:



Negro Gris

SILLAS GAMING

Sillas Gaming profesional de gran diseño deportivo, confort y versatilidad. Pensadas para disfrutar en tus momentos de ocio o de trabajo diario.

Ref: RD912



Ref: RD913



Ref: RD914

*Acabados con azul claro



ACABADOS SIMIL PIEL:



Rojo Azul Azul claro*

Todas las sillas son compatibles con nuestras ruedas de parquet RD917 (bajo pedido - Silla RD986 con ruedas de parquet de serie).

Para consultas relacionadas con medidas u otras especificaciones, consultar las características técnicas (pag. 18-19)



PRODUCTOS AUXILIARES

HOT DESK

Mueble multifuncional, diseñado para dar solución a las nuevas necesidades en forma de puesto de trabajo móvil.

COLOR PUERTA METÁLICA:



Gris

ESTRUCTURA E INTERIORES DE MELAMINA:



Haya



Gris

CARRO MULTIFUNCIONAL

Carro multifuncional, apto para servicios de almacenamiento y permitiendo una mejor organización en su nuevo espacio de trabajo.

COLOR ESTRUCTURA:



Gris

COLOR SUPERFICIES DE MELAMINA:



Haya



CARROS CARPETEROS

Carros carpeteros móviles, metálicos y regulables, de 1 o 2 niveles, según modelo.

COLOR ESTRUCTURA:



Negro



Blanco



Ref: RD310
(60 x 69 x 41 cm)





MESAS MÓBILES ERGONÓMICAS

Mesas de trabajo ergonómicas con diferentes regulaciones y niveles, que permiten trabajar en diferentes posiciones, según necesidad.

COLOR PUERTA METÁLICA:



Gris

SUPERFICIE DE MELAMINA:



Haya



Gris



Ref: 3050
(60 x 80 x 70 cm)



Ref: 3055
(80 x 73-110 x 50 cm)

MESAS MÓBILES PARA ORDENADORES

Mesas de ordenador funcionales y móviles, de estructura metálica. Baldas regulables en altura o teclado extraíble mediante guías, según modelo.

COLOR ESTRUCTURA:



Gris

SUPERFICIE DE MELAMINA:



Gris



Ref: 9100
(80 x 79 x 50 cm)



Ref: 5220
(80 x 73-110 x 50 cm)

KIT DE MESA DE DIBUJO TÉCNICO

Kit de dibujo semiprofesional. Mesa con estructura metálica regulable + tablero blanco de melamina 80 x 120cm + bandeja para útiles de 98cm de longitud + taburete móvil de altura ajustable, tapizado en tela ignífuga y de base metálica.

COLOR ESTRUCTURA:



Negro

SUPERFICIE DE MELAMINA:



Blanco

Ref: 030
Mesa (120 x 80 cm)



SKINWHITEBOARD

Es un panel multifuncional y pizarra modular, que gracias a su diseño moderno sin marco y con fijación magnética, permite su instalación tanto en vertical como en horizontal haciendo posibles infinitas composiciones, desde una unidad hasta cubrir una pared, creciendo según sus necesidades. Además, sus acabados y complementos aumentan su funcionalidad con múltiples usos para su hogar.

Pizarras certificadas con la certificación alemana GS, reconocida a nivel mundial como una de las mejores a nivel europeo en seguridad, calidad y continuidad de la fabricación del producto, dando al usuario una máxima seguridad y tranquilidad en su compra.

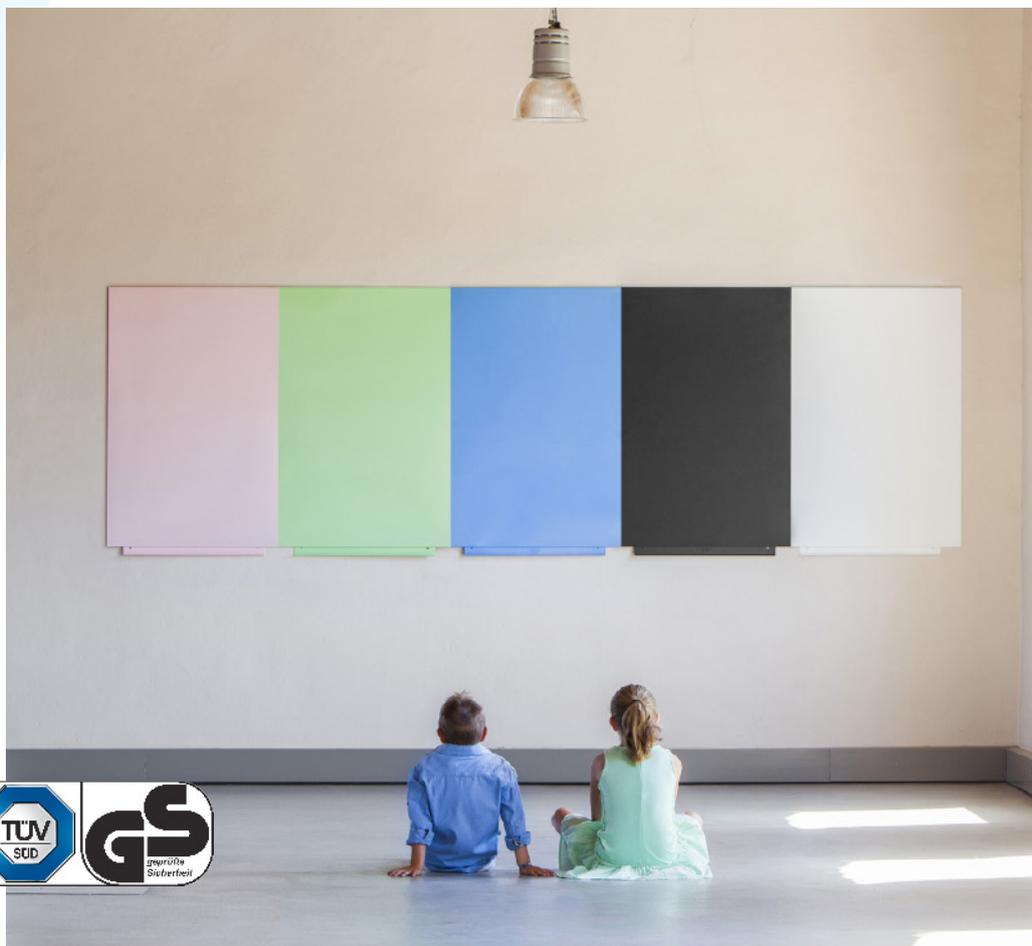

SKINPRO

Acabado especial con protección adicional de la superficie, que permite ser utilizada de forma muy frecuente ofreciendo las máximas garantías de calidad en el borrado, con un mantenimiento mínimo. 2 medidas disponibles.

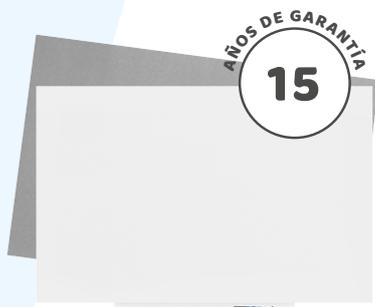

Ref: 6520PRO
(115 x 75 cm)
Ref: 6521PRO
(150 x 100 cm)

COLOR PIZARRA:



Lacada
(con protección adicional de la superficie)

SKINCOLOUR

Los diferentes acabados totalmente compatibles con los rotuladores de borrado en seco, combinan perfectamente con todo tipo de entornos, aportando valor extra a sus pizarras. 3 medidas disponibles.



Ref: 6419R
(75 x 55 cm)
Ref: 6420R
(115 x 75 cm)
Ref: 6421R
(150 x 100 cm)

26 COLORES A ELEGIR:



Pizarra lacada en todos sus acabados

SKINCLOCK

La SkinCLOCK es su pizarra perfecta para ayudarle a planificar y organizar todo tipo de tareas. Incluye calendario y reloj analógico de serie en la parte superior.

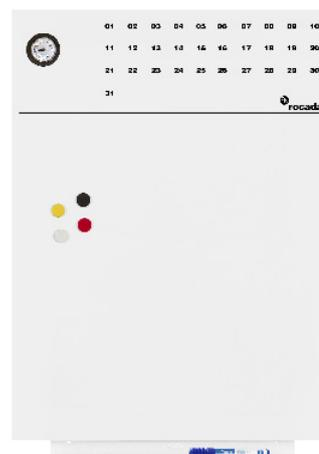

Ref: 6419CL
(55 x 75 cm)

COLOR PIZARRA:



Lacada

PIZARRAS DE PARED "NATURAL"

Las pizarras NATURAL combinan perfectamente con todo tipo de entornos dando un toque moderno, más cálido y más natural a su espacio. 2 medidas disponibles.



Ref: NAT6420
(115 x 75 cm)
Ref: NAT6421
(150 x 100 cm)

COLOR PIZARRA:



Lacada

ESTRUCTURA DE MELAMINA:



Roble

PIZARRAS CON MARCO DE ALUMINIO

Pizarras con marco de aluminio anodizado. Disponible en diferentes acabados según el tipo de pizarra y modelo: Vitrificada, lacada, tapizada o corcho. Disponible en múltiples medidas.

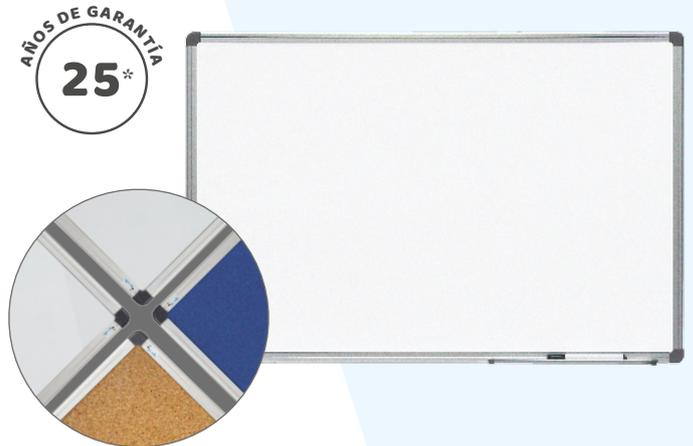

AÑOS DE GARANTÍA
25*

DISPONIBLE EN:



Vitrificada



Lacada



Tapizada



Corcho

PIZARRAS CON MARCO DE MADERA

Pizarras con marco de madera de pino, disponible en 3 superficies diferentes: Lacada, corcho o combinada (lacada + corcho). Disponible en múltiples medidas.

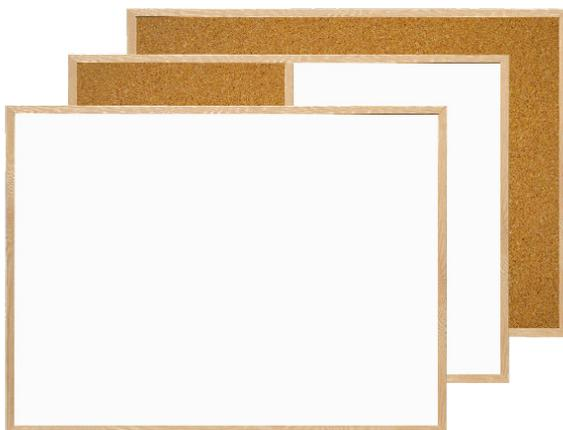

DISPONIBLE EN:



Melamina



Lacada/
Corcho



Corcho

ACCESORIOS PARA PIZARRAS

Amplia gama de accesorios para pizarras magnéticas: rotuladores, sprays de limpieza, notas informativas SkinnyNOTES, y cubilete magnético.



HOME OFFICE
by ROCADA

CARACTERÍSTICAS TÉCNICAS

p.4

SMART - MESA PLEGABLE DE PARED

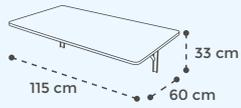

- Mesa con soporte plegable

p.5

SMART - MESA MÓVIL "TOCO"

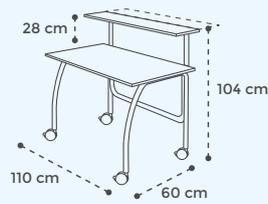

- 4 ruedas de parquet con freno.
- Segundo nivel regulable en 2 posiciones

p.6

E-TABLE

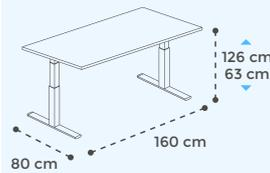

- Niveladores 2 cm
- Regulación en altura eléctrica
- Columna de 3 niveles

p.6

BLANCA

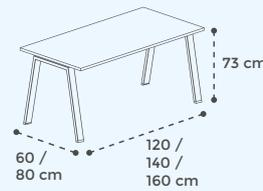

- Niveladores 2 cm

p.6

TOTAL

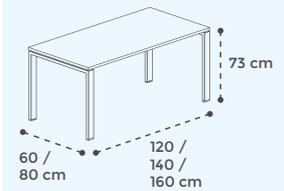

- Niveladores 2 cm

p.7

EXECUTIVE

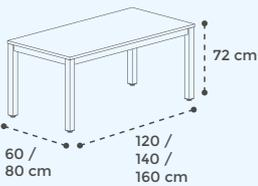

- Niveladores 5 cm

p.7

METAL

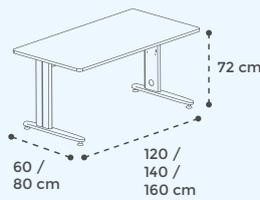

- Niveladores 2 cm
- Sistema de electrificación incorporado

p.7

WORK

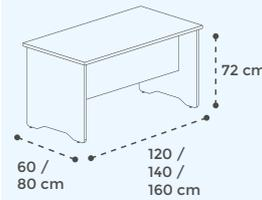

- Niveladores 2 cm
- Faldón con paso de cables

p.8

SOPORTE CPU PARA MESAS "METAL"

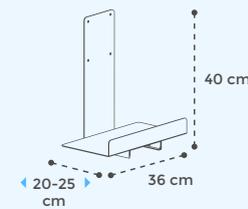

- Compatible con nuestras mesas "METAL"
- Ventilación CPU
- Regulación en anchura

p.8

SOPORTE CPU PARA MESAS

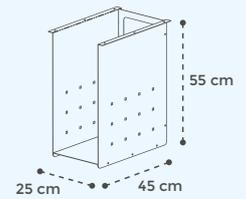

- Compatible con todas nuestras mesas con superficies de melamina
- Ventilación CPU

p.8

SOPORTE PARA TECLADO Y RATÓN DE ORDENADOR

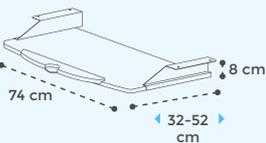

- Compatible con mesas con superficies de melamina
- Bandeja extraíble
- Sistema antivuelco

p.8

ELECTRIFICACIÓN

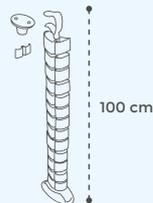

- Compatible con mesas con superficies de cristal y superficies de melamina
- Flexible

p.9

PASACABLES

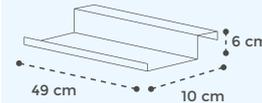

- Compatible con mesas con superficies de cristal y superficies de melamina

p.9

SOPORTE MÓVIL CPU

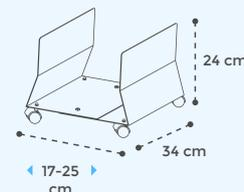

- 4 ruedas con freno
- Regulación en anchura

p.9

PAPELERA 20 LITROS

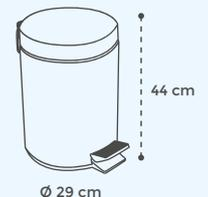

- Cubo interior extraíble
- Pedal de obertura

p.10

ARMARIO METÁLICO

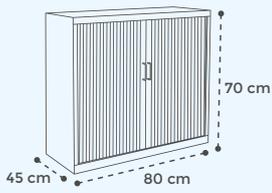

- Niveladores 2 cm
- Cerradura de serie
- Baldas regulables en altura
- Compatible con carpetas colgantes tamaño DIN A4

p.10

ARCHIVADORES METÁLICOS

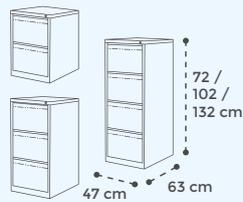

- Cerradura de serie
- Sistema antivuelco
- Portaetiquetas
- Compatible con carpetas DIN A4, folio y folio prolongado

p.10

BUCKS METÁLICOS

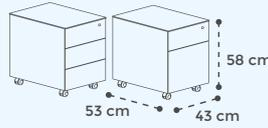

- 4 ruedas con freno
- Cerradura de serie
- Sistema antivuelco
- Cajón carpetero compatible con carpetas colgantes tamaño DIN A4

p.10

ARMARIOS COLUMNA DE MELAMINA

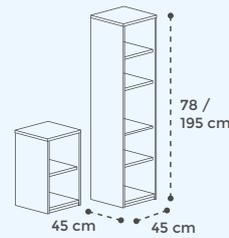

- Niveladores 2 cm
- Baldas regulables en altura

p.10

BUCKS DE MELAMINA

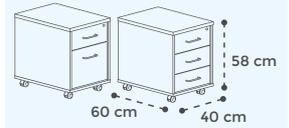

- 4 ruedas con freno
- Cerradura de serie
- Sistema antivuelco
- Cajón carpetero compatible con carpetas colgantes tamaño DIN A4

p.10

CORTINAS ENROLLABLES

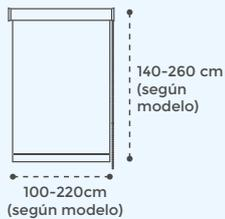

- Tela inífuga (poliéster 30% y PVC 70%)
- Regulación en altura mediante mecanismo con cadena
- Factor de apertura 5%

p.11

SILLA DIRECCIÓN RD986



- Ruedas de parquet de serie
- Regulación en altura
- Reposabrazos fijos
- Simil piel
- Mecanismo basculante

p.11

SILLA OPERATIVA RD937



- Compatible con ruedas de parquet RD917
- Regulación en altura, profundidad, respaldo, lumbar y reposabrazos
- Tapizada
- Mecanismo sincro-basculante

p.11

SILLA OPERATIVA RD908



- Compatible con ruedas de parquet RD917
- Regulación en altura, lumbar y reposabrazos
- Tapizada
- Mecanismo sincro-basculante

p.11

SILLA OPERATIVA RD908W



- Compatible con ruedas de parquet RD917
- Regulación en altura, lumbar y reposabrazos
- Tapizada
- Mecanismo sincro-basculante

p.11

SILLA OPERATIVA RD907



- Compatible con ruedas de parquet RD917
- Regulación en altura, y reposabrazos
- Tapizada
- Mecanismo basculante

p.11

SILLA OPERATIVA RD930+956



- Compatible con ruedas de parquet RD917
- Regulación en altura
- Reposabrazos fijos
- Tapizada
- Mecanismo de contacto permanente

p.11

SILLA OPERATIVA RD930



- Compatible con ruedas de parquet RD917
- Regulación en altura
- Sin reposabrazos
- Tapizada
- Mecanismo de contacto permanente

p.11

TABURETE BE SOFT 1828-4-1

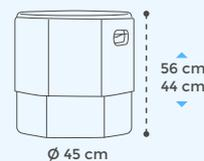

- Regulación en altura
- Base ergonómica con balanceo
- Tapizado

p.11

SILLA GAMING RD912



- Compatible con ruedas de parquet RD917
- Regulación en altura
- Reposabrazos fijos
- Simil piel

p.11

SILLA GAMING RD913



- Compatible con ruedas de parquet RD917
- Regulación en altura
- Reposabrazos fijos
- Simil piel
- Mecanismo basculante

p.11

SILLA GAMING RD914



- Compatible con ruedas de parquet RD917
- Regulación en altura, lumbar, cervical y reposabrazos
- Simil piel
- Mecanismo basculante
- Respaldo reclinable 155°

p.12

HOT DESK

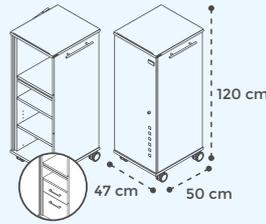

- 4 ruedas con freno
- Cerradura de serie
- Tapa superior escamotable
- Pasacables incorporado
- Cajón carpetero compatible con carpetas tamaño DIN A4

p.12

CARRO MULTIFUNCIONAL

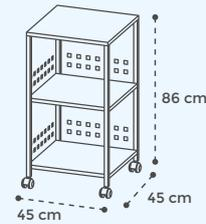

- 4 ruedas con freno
- Paneles laterales intercambiables

p.12

CARRO CARPETERO RD300

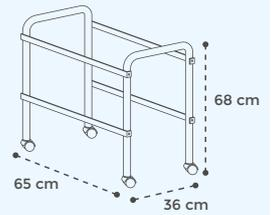

- 4 ruedas con freno
- Compatible con carpetas colgantes de tamaño folio

p.12

CARRO CARPETERO RD310

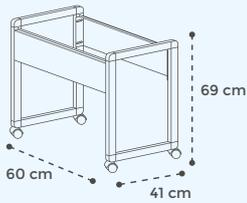

- 4 ruedas con freno
- Compatible con carpetas colgantes de tamaño DIN A4, folio y folio prolongado

p.13

MESA MÓBIL ERGONÓMICA "MILAGRO"

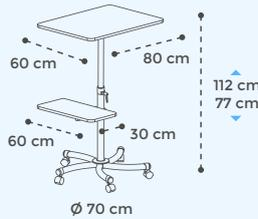

- 5 ruedas con freno
- Regulación en altura
- Superficies regulables en altura

p.13

MESA MÓBIL ERGONÓMICA "ADJUST"

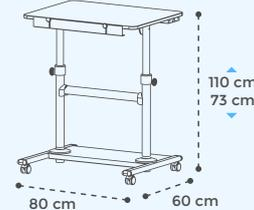

- 4 ruedas con freno
- Regulación en altura
- Regulación en inclinación 80°
- Cajón lateral derecha e izquierda de 74 cm para accesorios

p.13

MESA MÓBIL PARA ORDENADORES



- 4 ruedas con freno
- Bandeja extraíble

p.13

MESA MÓBIL REGULABLE PARA ORDENADORES



- 4 ruedas con freno
- Bandeja extraíble
- Estanterías regulables en altura
- Reposamuñecas desplegable

p.13

KIT DE MESA DE DIBUJO TÉCNICO

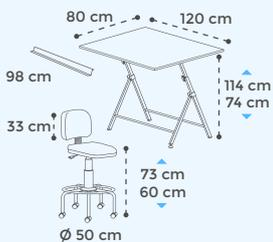

- Kit de dibujo, incorpora: mesa + bandeja para lápices + taburete con reposapiés
- Mesa y taburete regulables en altura

p.14

SKIN PRO

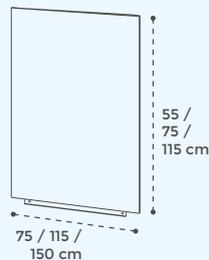

- Superficie lacada con protección adicional (PET)
- Bandeja portaútiles extraíble
- Superficie apta para rotuladores de borrado en seco

p.14

SKIN COLOUR

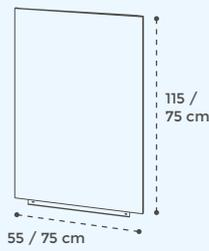

- Superficie lacada
- Bandeja portaútiles extraíble
- Superficie apta para rotuladores de borrado en seco

p.14

SKIN CLOCK

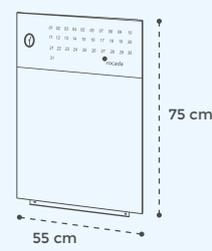

- Superficie lacada
- Bandeja portaútiles extraíble
- Superficie apta para rotuladores de borrado en seco
- Reloj incluido

p.14

PIZARRA DE PARED "NATURAL"

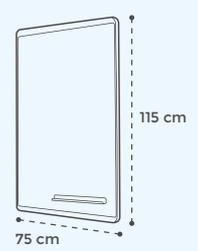

- Superficie lacada
- Soporte de melamina
- Bandeja magnética incluida
- Superficie apta para rotuladores de borrado en seco

PIZARRAS VITRIFICADAS CON MARCO DE ALUMINIO

p.15

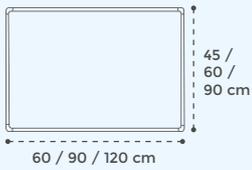

- Superficie vitrificada
- Bandeja portaútiles incluida
- Superficie apta para rotuladores de borrado en seco

PIZARRAS LACADAS CON MARCO DE ALUMINIO

p.15



- Superficie lacada
- Bandeja portaútiles incluida
- Superficie apta para rotuladores de borrado en seco

PIZARRAS TAPIZADAS CON MARCO DE ALUMINIO

p.15

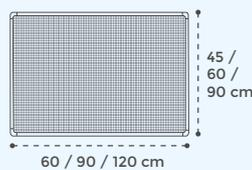

- Superficie tapizada
- Superficie apta para sujeción de la información mediante chinchetas.

PIZARRAS DE CORCHO CON MARCO DE ALUMINIO

p.15

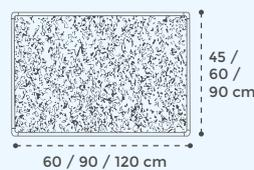

- Superficie de corcho autorregenerable
- Superficie apta para sujeción de la información mediante chinchetas

PIZARRAS DE MELAMINA CON MARCO DE MADERA

p.15

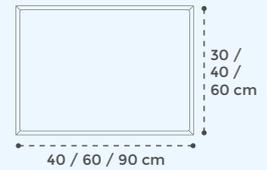

- Superficie de melamina
- Superficie apta para rotuladores de borrado en seco
- Cajas de 5 o 10 unidades según modelo

PIZARRAS LACADA/CORCHO CON MARCO DE MADERA

p.15

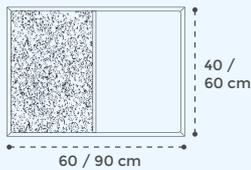

- Dos superficies: 1/2 superficie lacada y 1/2 superficie de corcho autorregenerable
- Cajas de 5 o 10 unidades según modelo

PIZARRAS DE CORCHO CON MARCO DE MADERA

p.15

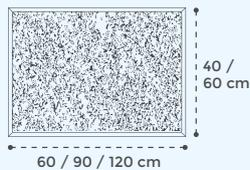

- Superficie de corcho autorregenerable
- Superficie apta para sujeción de la información mediante chinchetas
- Cajas de 5 o 10 unidades según modelo

SERVICIO DE MONTAJE BAJO PEDIDO

Ofrecemos la posibilidad de montar cualquier material en cualquier punto del territorio español por un módico precio sin pedido mínimo.

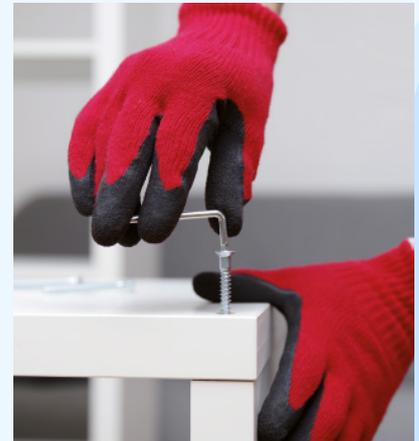

GRAN VARIEDAD EN MEDIDAS Y ACABADOS

En Rocada tenemos una gran variedad en medidas y acabados, aparte de las descritas en esta oferta. Póngase en contacto con Rocada para consultar cualquier otra medida y acabado: rocada@rocada.com.

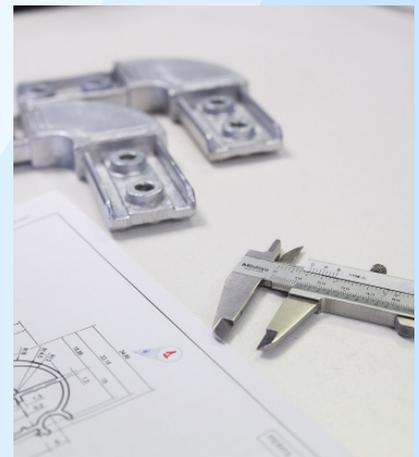

CALIDAD Y FIABILIDAD

La calidad y fiabilidad de nuestros procesos de producción están avalados por la certificación ISO 9001:2015



MEDIOAMBIENTE

Respetar y proteger el medioambiente es prioritario en nuestros procesos productivos. El uso de productos reciclados y la utilización razonable de los recursos son prioridades inexcusables.



INTERSEROH

Servicios ambientales con un enfoque integrado para cerrar los bucles de los productos, soluciones de reciclaje y estrategias de prevención de residuos que establecen estándares en toda la industria.



FFP1 CE certificate
Code: 4Q200328R.DCI0097

MASCARILLAS DE PROTECCIÓN

Para pedidos superiores a 500€ netos,
de regalo una caja de 50 unidades
de mascarillas quirúrgicas.

*Promoción válida hasta agotar existencias.



rocada

Rocada HQ (Spain)
rocada@rocada.com
www.rocada.com

Rocada Deutschland GmbH
info@rocada.de
www.rocada.de

Rocada Japan LLC
info@rocada.co.jp



rocada

Rocada HQ (Spain)
rocada@rocada.com
www.rocada.com

Rocada Deutschland GmbH
info@rocada.de
www.rocada.de

Rocada Japan LLC
info@rocada.co.jp





rocada

PROTECCIÓN MUTUA PARA UN BIENESTAR COMÚN

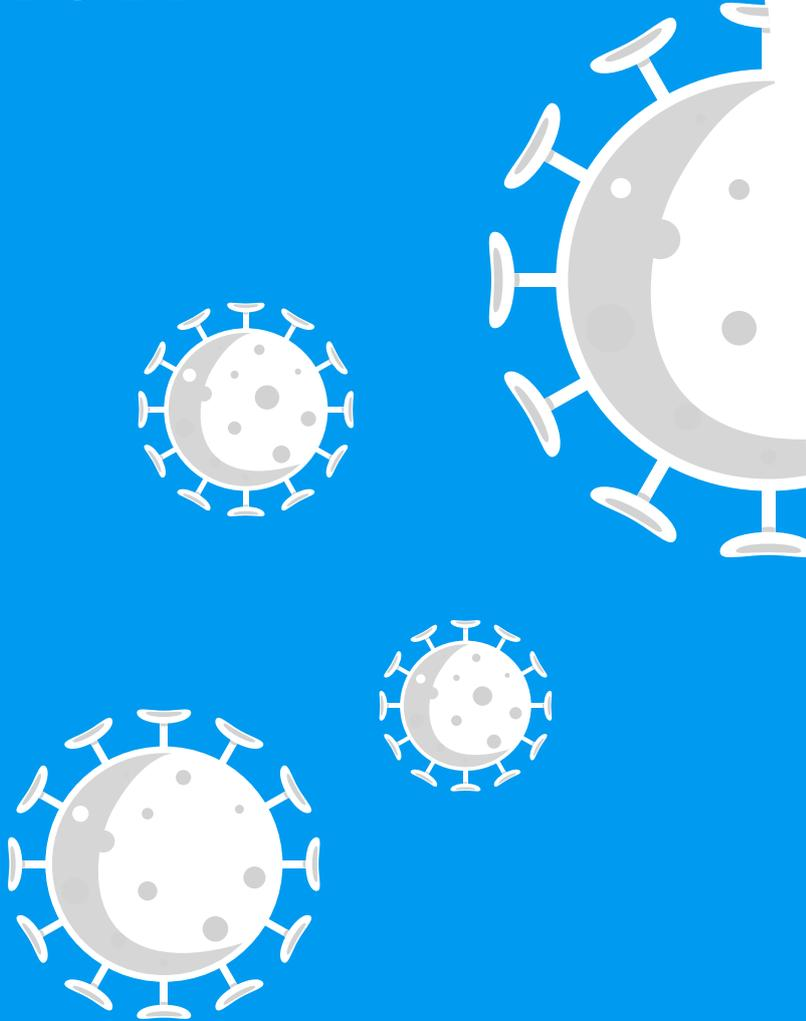

Nueva línea de productos **ROCADA**, adaptados a las necesidades de prevención y protección actuales.



PERSONALIZACIÓN BAJO PEDIDO



FABRICACIÓN ESPECIAL

Al ser fabricantes podemos fabricar a medida. Para consultas relacionadas con productos especiales contactar con **ROCADA**.



Rocada HQ (Spain)
rocada@rocada.com
www.rocada.com

Rocada Deutschland GmbH
info@rocada.de
www.rocada.de

Rocada Japan LLC
info@rocada.co.jp



CALIDAD Y FIABILIDAD

La calidad y fiabilidad de nuestros procesos de producción están avalados por la certificación ISO 9001:2015.



MEDIOAMBIENTE

Respetar y proteger el medioambiente es prioritario en nuestros procesos productivos. El uso de productos reciclados y la utilización razonable de los recursos son prioridades inexcusables.



INTERSEROH

Servicios ambientales con un enfoque integrado para cerrar los bucles de los productos, soluciones de reciclaje y estrategias de prevención de residuos que establecen estándares en toda la industria.



FFP1 CE certificate
Code: 4Q200328R.DCI0097

Image by Myo Min Kyaw from Pixabay (www.pixabay.com) & Freepik (www.freepik.com)

MASCARILLAS DE PROTECCIÓN

Para pedidos superiores a 500€ netos,
de regalo una caja de 50 unidades
de mascarillas quirúrgicas.



rocada

Rocada HQ (Spain)
rocada@rocada.com
www.rocada.com

Rocada Deutschland GmbH
info@rocada.de
www.rocada.de

Rocada Japan LLC
info@rocada.co.jp

*Promoción válida hasta agotar existencias.

MAMPARA MODULAR DE CRISTAL TEMPLADO CON PIES DE MADERA

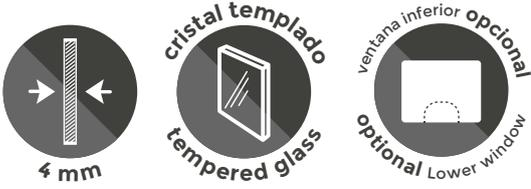

COV-BLWG8570



Soporte de madera natural de gran calidad.



COV-BLG8570

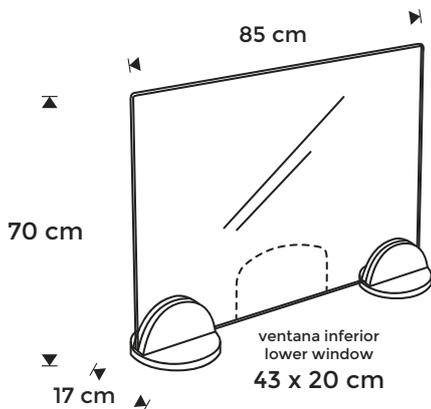

Mampara modular de cristal templado de 4 mm de espesor, con pies ajustables realizados en madera natural, que permite una adaptación según la necesidad deseada, pudiendo elegir entre 2 modelos de sobremesa, con o sin ventana, donde podremos colocar el cristal en horizontal o vertical. Gracias a sus características, el cristal templado aporta ventajas de limpieza y durabilidad frente a otros materiales plásticos.

El sistema de fijación de los pies permite unir módulos entre ellos para conseguir la medida deseada.

REF	MATERIAL	MEDIDAS
COV-BLG8570	Cristal Templado	85 x 70 x 17 cm
COV-BLWG8570	Cristal Templado / Ventana	85 x 70 x 17 cm

*Medidas: Ancho x alto x fondo.

MAMPARA DE GRAN FORMATO CON PANTALLA ACRÍLICA Y ESTRUCTURA DE ALUMINIO

 **rocada**



Ruedas con
freno de serie.
Opción de
niveladores
(bajo pedido)



Mampara acrílica de 5mm de espesor con marco de aluminio anodizado color aluminio de 100 x 180 cm. Pies realizados en chapa de acero que permiten la utilización de niveladores o de ruedas según necesidad.

Disponible en varias medidas (bajo pedido). Consultar para más información.

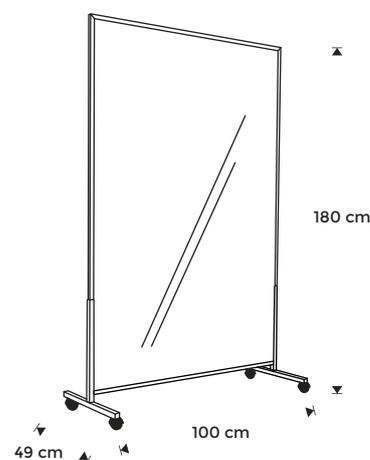

REF	MATERIAL	MEDIDAS
COV-AF1018	Acero / Acrílico	100 x 180 x 49 cm

*Medidas: Ancho x alto x fondo.



CORTINAS TRANSPARENTES ENROLLABLES

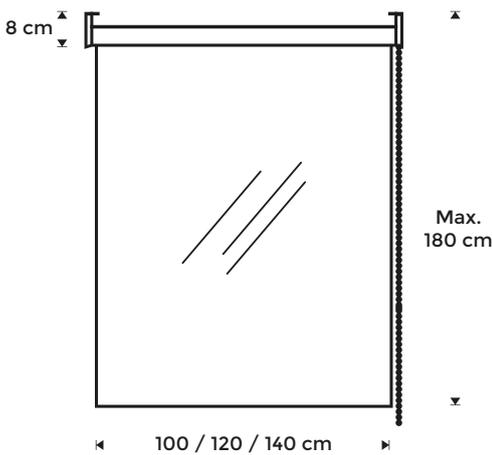

Permite adaptar la protección deseada en cada momento ajustando la longitud de la cortina según sus necesidades. Fijación al techo de fácil instalación.

Nota: por defecto, la cadena viene instalada a la derecha. En caso que se prefiera la instalación de la cadena a la izquierda se debe especificar en la hoja del pedido.



Para más información, consultar nuestra gama de cortinas enrollables en nuestra web:
www.rocada.com

REF	MATERIAL	MEDIDAS
ROLL10-18T9005	PVC	100 x 180 x 8 cm
ROLL12-18T9005	PVC	120 x 180 x 8 cm
ROLL14-18T9005	PVC	140 x 180 x 8 cm

*Medidas: Ancho x alto x fondo.

MAMPARA REGULABLE DE CRISTAL TEMPLADO ESPECIAL RECEPCIONES



COV-EPG8570
Soporte para pared.
Fijación de la pantalla
en 2 posiciones.



COV-EWG8570
Soporte para superficie.
Fijación de la pantalla
en 2 posiciones.

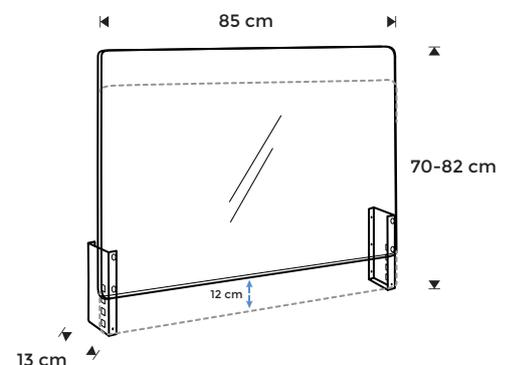
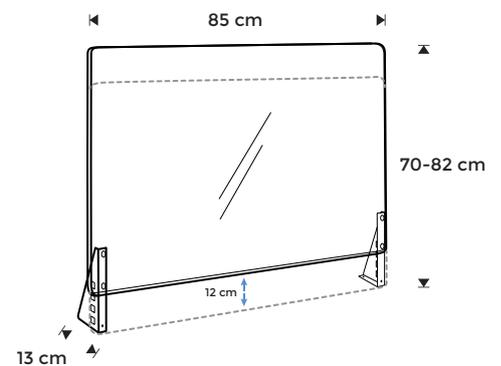

Mampara regulable en altura para adaptar el nivel de protección de cada espacio. Pensada para instalar en recepciones donde la repisa del mostrador es muy estrecha o bien para ventanas fijándola directamente a la pared. Es la solución de protección ideal para secretarías de colegios, empresas, garitas de seguridad, etc. El diseño de los pies permite instalar el panel frontal en 2 posiciones, así como la fijación de la mampara a la repisa de recepción mediante tornillos para evitar su desplazamiento. Gracias a sus características, el cristal templado aporta ventajas de limpieza y durabilidad frente a otros materiales plásticos.

REF	MATERIAL	MEDIDAS
COV-EWG8570	Cristal templado / Acero	85 x 70-82 x 13 cm
COV-EPG8570	Cristal templado / Acero	85 x 70-82 x 13 cm

*Medidas: Ancho x alto x fondo.



3 mm



MAMPARA ACRÍLICA CON FIJACIÓN A TECHO



Incluye cadena de bolas de plástico (6 m de largo)



Coffee photo created by cookie_studio - www.freepik.com

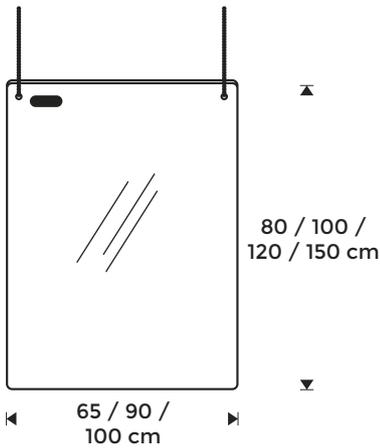

Mampara protectora con fijación a techo, ideal para recepciones en hospitales, supermercados, gasolineras, farmacias, panaderías, etc. Previene la infección por transmisión de gotas. Fabricada con acrílico de 3mm de espesor de fácil limpieza.

Montaje con fijación a techo (suspendido). Incluye cadena de bolas de plástico (Ø 3,2 mm, 6 m de largo) para fijar el panel en formato vertical u horizontal.

REF	MATERIAL	MEDIDAS
COV-EO865	Acrílico	65 x 80 x 3 cm
COV-EO1065	Acrílico	65 x 100 x 3 cm
COV-EO129	Acrílico	90 x 120 x 3 cm
COV-EO1510	Acrílico	100 x 150 x 3 cm

*Medidas: Ancho x alto x fondo.

MAMPARA DE SOBREMESA CON FRONTAL DE CRISTAL TEMPLADO Y PIES REDONDOS



años de garantía (cristal)
25
years guarantee (glass)



Soporte redondo
de diseño simple
y robusto.

Mampara protectora de gran diseño pensada para oficinas y negocios. Separa físicamente a las personas entre sí para conseguir una máxima protección ante cualquier infección por transmisión de gotas. Ventana inferior opcional de 43 cm de ancho y 20 cm de altura. Pies de diseño simple y robusto realizados en chapa de acero pintado. Panel de cristal templado de 4mm. Se puede limpiar con todo tipo de desinfectantes y limpiacristales sin dañar la superficie. Gracias a sus características, el cristal templado aporta ventajas de limpieza y durabilidad frente a otros materiales plásticos.

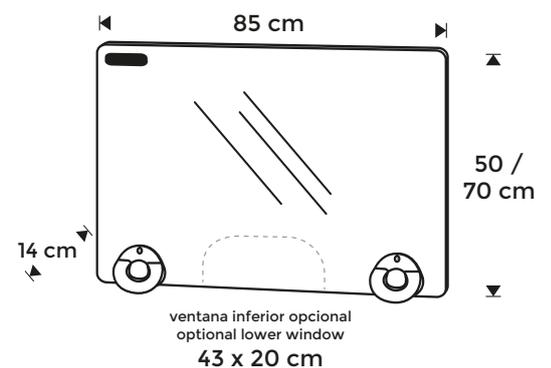

REF	MATERIAL	MEDIDAS
COV-ERG8550	Cristal templado	85 x 50 x 14 cm
COV-ERG8570	Cristal templado	85 x 70 x 14 cm
COV-ERWG8570	Cristal templado / Ventana	85 x 70 x 14 cm

*Medidas: Ancho x alto x fondo.

MAMPARA REGULABLE DE SOBREMESA CON FRONTAL DE CRISTAL TEMPLADO Y PIES TRIANGULARES



El diseño de los pies permite la fijación de la pantalla en 2 posiciones.



Mampara protectora regulable en altura pensada para una máxima adaptación a todo tipo de necesidades, tanto para oficinas como negocios que impliquen un contacto directo con otras personas. El diseño de los pies permite ajustar la posición del panel en 2 alturas (totalmente cerrada o abierta en la parte inferior 12 cm), así como la fijación de la pantalla a la mesa para evitar que se desplace o caiga. Pies realizados en chapa de acero pintado. Panel de cristal templado de 4mm. Ventana inferior opcional de 43 cm de ancho y 20 cm de altura. Se puede limpiar con todo tipo de productos desinfectantes. Gracias a sus características, el cristal templado aporta ventajas de limpieza y durabilidad frente a otros materiales plásticos.

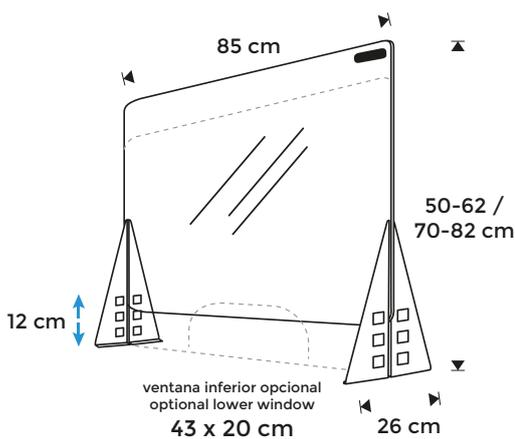

REF	MATERIAL	MEDIDAS
COV-ETG8550	Cristal templado	85 x 50-62 x 26 cm
COV-ETG8570	Cristal templado	85 x 70-82 x 26 cm
COV-ETWG8570	Cristal templado / Ventana	85 x 70-82 x 26 cm

*Medidas: Ancho x alto x fondo.

MAMPARA REGULABLE DE SOBREMESA CON FRONTAL DE CRISTAL TEMPLADO Y PIES TUBULARES



Robusta estructura metálica que permite la fijación de la pantalla en 2 posiciones.

Mampara protectora de 2 posiciones con robusta estructura metálica para oficinas y negocios. Separa físicamente a las personas entre sí para conseguir una máxima protección ante cualquier infección por transmisión de gotas. Gracias a su diseño, permite la fijación de la pantalla en 2 posiciones, abierta en la parte inferior 5cm, o subirla hasta 19cm. Pies realizados en tubo de acero pintado. Máxima protección para un bienestar común. Panel de cristal templado de 4mm. Se puede limpiar con todo tipo de desinfectantes o limpiacristales sin dañar la superficie. Las características del cristal templado aportan ventajas de limpieza y durabilidad frente a otros materiales plásticos.

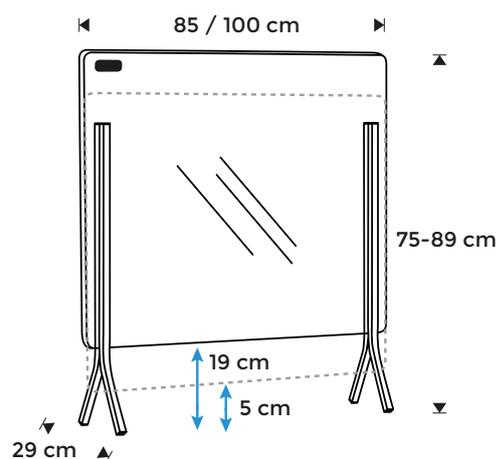

REF	MATERIAL	MEDIDAS
COV-EYG8570	Cristal templado	85 x 75-89 x 29 cm
COV-EYG1070	Cristal templado	100 x 75-89 x 29 cm

*Medidas: Ancho x alto x fondo.



MAMPARA DE SOBREMESA CON FRONTAL ACRÍLICO Y ESTRUCTURA DE ALUMINIO



Estructura de aluminio anodizado plateado y pie de 42 cm de profundidad.

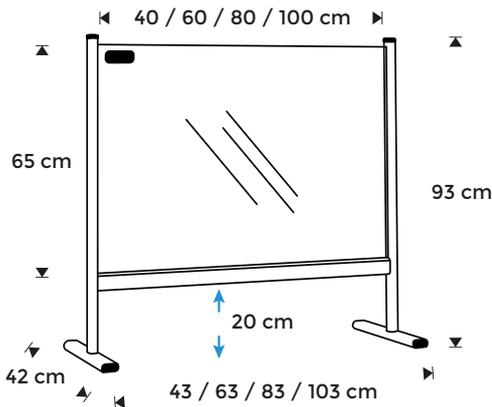

Mampara protectora para separar físicamente a las personas entre sí, y permite a la vez intercambiar objetos según cada puesto de trabajo. Ideal para estaciones de servicio, farmacias, consultorios médicos, oficinas entre otros. Dispone de un espacio inferior para poder intercambiar lo necesario en cada puesto de trabajo. Estructura de aluminio anodizado plateado y pie de 42 cm de profundidad. Barra transversal para una mejor estabilidad.

REF	MATERIAL	MEDIDAS
COV-D64P	Aluminio / Acrílico	43 x 93 x 42 cm
COV-D66P	Aluminio / Acrílico	63 x 93 x 42 cm
COV-D86P	Aluminio / Acrílico	83 x 93 x 42 cm
COV-D106P	Aluminio / Acrílico	103 x 93 x 42 cm

*Medidas: Ancho x alto x fondo.

MAMPARA DE SOBREMESA CON FRONTAL Y PIES EN ACRÍLICO

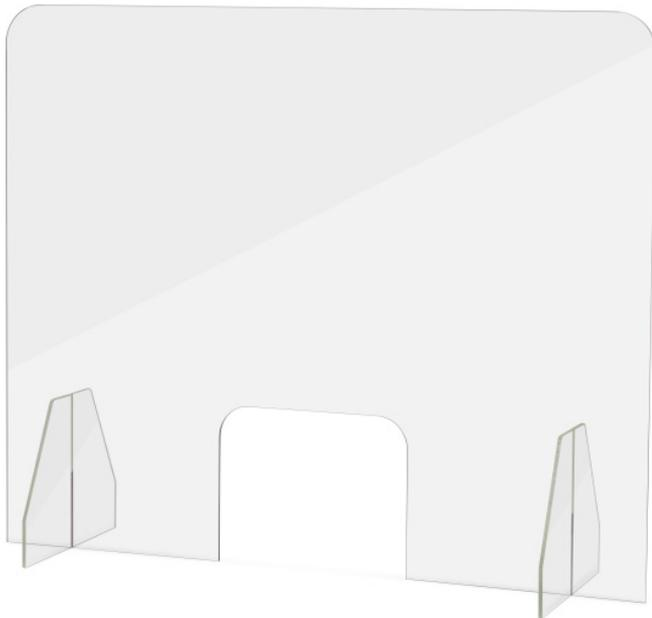

COV-ES8470



COV-ES5081



COV-ES7084



Pies en acrílico y
ventana inferior
de 25 cm de ancho
x 20 cm de altura.

Mampara protectora diseñada para negocios con una zona para la caja registradora y/o con mostrador que implique un contacto directo con otras personas. Separa físicamente a las personas entre sí y gracias a su apertura inferior permite pasar los productos comprados, así como el pago de los mismos. Ideal para estaciones de servicio, farmacias, consultorios médicos y otros. Apertura inferior de 25 cm x 20 cm. Protección ante cualquier estornudo, previene la infección por transmisión de gotas. Se puede limpiar con todo tipo de desinfectante.

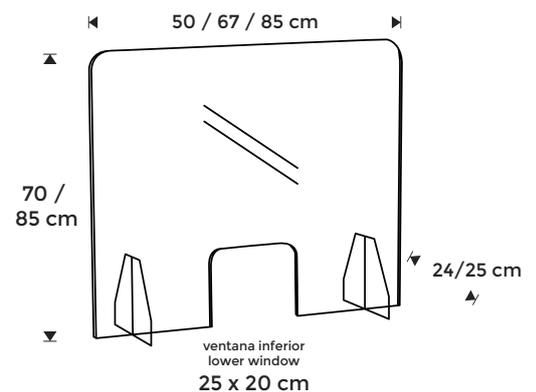

REF	MATERIAL	MEDIDAS
COV-ES5081	Acrílico	50 x 85 x 25 cm
COV-ES7084	Acrílico	67 x 85 x 24 cm
COV-ES8470	Acrílico	85 x 70 x 25 cm

*Medidas: Ancho x alto x fondo.

PANEL SEPARADOR DE CRISTAL TEMPLADO PARA MESAS DE OFICINA

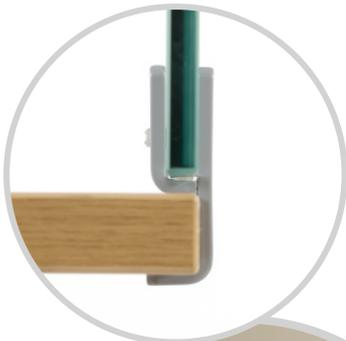

Sistema de anclaje de fácil fijación.

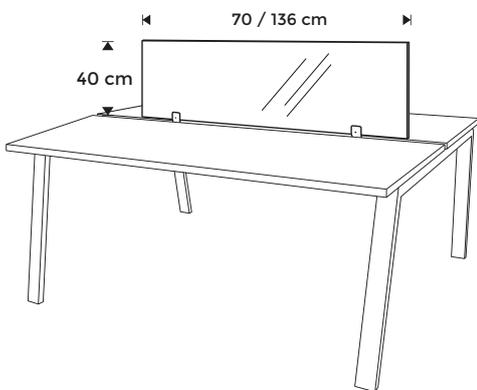

Paneles separadores de cristal templado de 10mm de espesor con acabado translúcido pensado para dar protección y privacidad a cada puesto de trabajo. Sistema de anclaje de fácil fijación.

REF	MATERIAL	MEDIDAS
2916IE	Cristal templado	70 x 40 x 1 cm
2917IE	Cristal templado	136 x 40 x 1 cm

*Medidas: Ancho x alto x fondo.

MAMPARA MÓVIL REGULABLE EN ALTURA CON PANTALLA ACRÍLICA

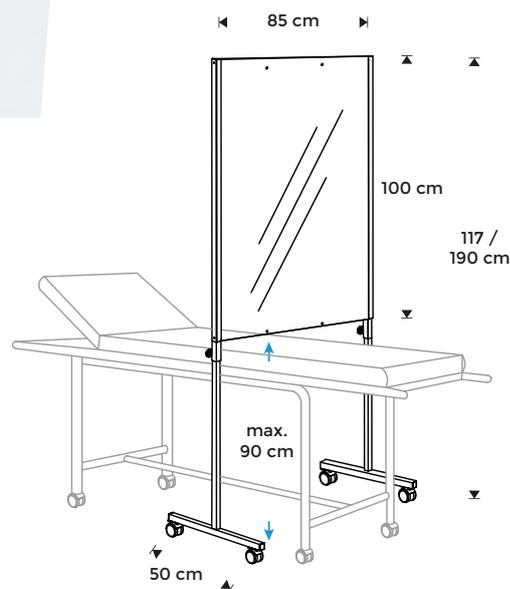

Mampara protectora móvil y regulable en altura diseñada especialmente para dar solución a los centros de estética, podólogos, etc en los que sea necesario salvar camas o camillas. Medida interior de 80cm. Robusta estructura realizada en tubo de acero. Pantalla realizada en acrílico de 3mm de espesor. Protección ante cualquier estornudo, previene la infección por transmisión de gotas. Ruedas con freno.

REF	MATERIAL	MEDIDAS
COV-CAM80	Acrílico	85 x 117-190 x 50 cm

*Medidas: Ancho x alto x fondo.



MAMPARA ACRÍLICA CON FORMA DE "U" ESPECIAL PUPITRES

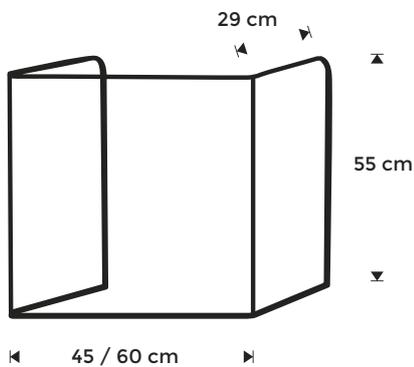
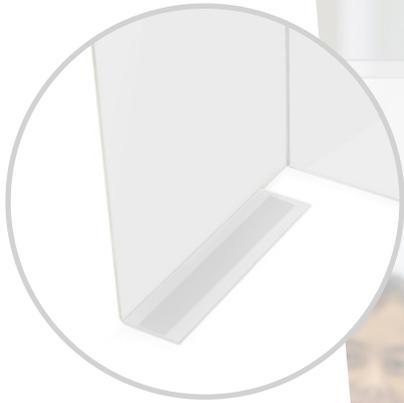

Mampara de protección especial para el alumnado. Fijación en las superficies de las mesas mediante sistema adhesivo de doble cara.

Máxima eficacia en las aulas educativas.

REF	PACKS	MATERIAL	MEDIDAS
COV-SKOOL01	4u	Acrílico	45 x 55 x 29 cm
COV-SKOOL02	4u	Acrílico	60 x 55 x 29 cm

*Medidas: Ancho x alto x fondo.

MAMPARA ACRÍLICA DE SOBREMESA EN FORMA DE CRUZ

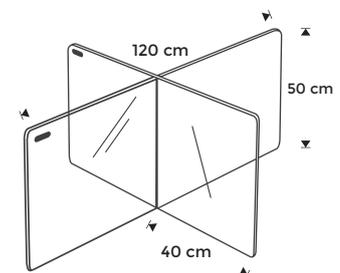
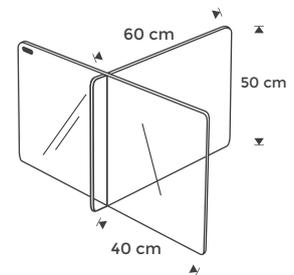

Paneles acrílicos de 5mm de espesor pensados para hostelería (restaurantes y cafeterías) proporcionando una máxima protección entre los comensales.

Sus diferentes combinaciones permiten adaptarse a cada momento.

REF	DIVISIONES / MATERIAL	MEDIDAS
COV-CROS2	Para 2 personas / Acrílico	60 x 50 x 80 cm
COV-CROS4	Para 4 personas / Acrílico	120 x 50 x 80 cm

*Medidas: Ancho x alto x fondo.

MAMPARA DE CRISTAL TEMPLADO PARA NUESTRA GAMA DE PRODUCTOS BE SOFT

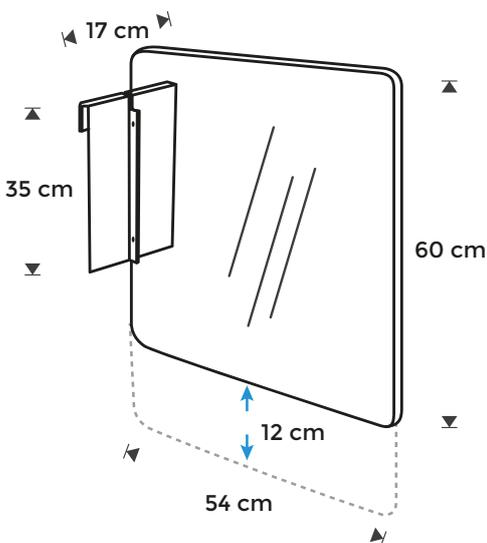

Pantalla protectora de cristal de 6 mm de espesor y regulable en altura (2 posiciones). Pensada para una máxima adaptación a todo tipo de necesidades. Complemento perfecto para la gama de sofás Be Soft.



Para más información, consultar nuestro catálogo BE SOFT:
[www.rocada.com/
document/be-soft-2020.pdf](http://www.rocada.com/document/be-soft-2020.pdf)

REF	MATERIAL	MEDIDAS
COV-BE1805	Cristal templado	54 x 60 x 17 cm

*Medidas: Ancho x alto x fondo.

PANEL SEPARADOR CON PIZARRA DE DOBLE CARA, LACADA Y MAGNÉTICA



Superficie
lacada con
marco de
aluminio
anodizado.



Soporte móvil
telescópico
y ruedas con
freno incluidas.

Soportes con robusta estructura realizada en acero que permiten la fijación de pizarras magnéticas de doble cara lacadas aptas para la escritura de rotuladores de borrado en seco.

Pizarra lacada magnética para uso con rotuladores de borrado en seco incluida.

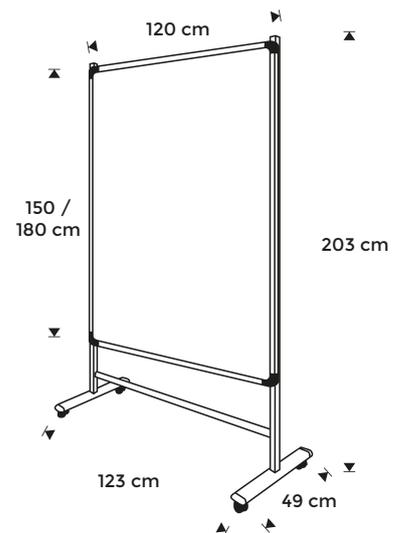

REF	MATERIAL	MEDIDAS
COV-6951PK	Pizarra lacada (120 x 150 cm)	123 x 203 x 49 cm
COV-6952PK	Pizarra lacada (120 x 180 cm)	123 x 203 x 49 cm

*Medidas: Ancho x alto x fondo.



SEPARADOR MÓVIL MODULAR TAPIZADO DE DOBLE CARA

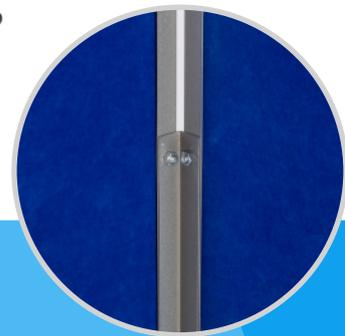
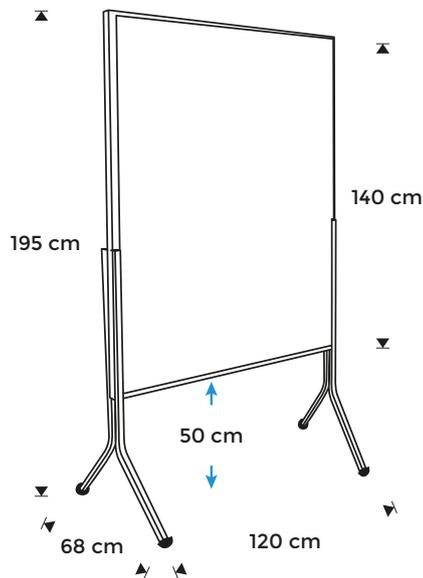

ref: RD8115
Sistemas de unión
para formar múltiples
combinaciones.

Separador móvil de doble cara de estructura metálica y superficie blanda para chinchetas y notas. Gracias a su resistente superficie absorbe la sonoridad. Ruedas de serie.

Permite múltiples combinaciones gracias a RD8115 (elementos de unión).

REF	PACK	MATERIAL	MEDIDAS
RD8100	1u	Tapizado gris	120 x 195 x 68 cm
RD8100/2	1u	Tapizado azul	120 x 195 x 68 cm
RD8115	2u	Acero	54 x 4 cm

*Medidas: Ancho x alto x fondo.

PIZARRA MÓVIL DE DOBLE CARA DE NUESTRA GAMA NATURAL

 **rocada**

con ruedas

with wheels

años de garantía (pizarra)
2
years guarantee (whiteboard)



Soporte móvil de doble cara de la gama NATURAL, con pizarras lacadas en ambos lados totalmente compatibles con los rotuladores de borrado en seco. Soporte móvil de melamina con un diseño moderno y minimalista, con 4 ruedas en los pies para su desplazamiento y movilidad. Medida útil de la superficie de escritura de 92 x 120 cm en ambos lados. Bandeja magnética de 40 cm incluida. Fácil montaje.



Para más información,
consultar nuestro catálogo
NATURAL:
[www.rocada.com/document/
natural-2020.pdf](http://www.rocada.com/document/natural-2020.pdf)

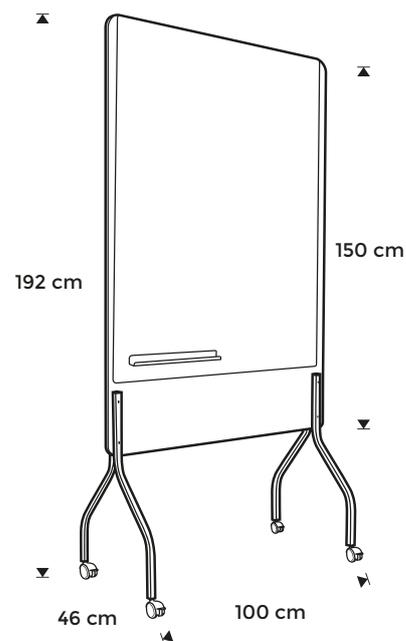

REF	MATERIAL	MEDIDAS
NAT8100	Acero / Melamina	100 x 192 x 46 cm

*Medidas: Ancho x alto x fondo.



BANDEJA PORTAÚTILES DE CRISTAL TEMPLADO PARA PIZZARRAS MÓVILES



Bandeja de cristal templado de grandes dimensiones.

Pizarra móvil magnética con estructura metálica de la gama NATURAL, fabricada con un soporte de melamina. Superficie lacada apta para la escritura con rotuladores de borrado en seco y con base de melamina de 5 ruedas de gran diseño. Embellecedor en la parte superior para esconder los pomos de sujeción del papel universal. Incluye 2 brazos abatibles de serie. Fácil montaje. Medida útil de la superficie de escritura 69 x 99 cm.

Bandeja de cristal templado de 8 mm de espesor de grandes dimensiones para poder disponer de elementos de protección como gel o guantes durante cualquier reunión.



Para más información, consultar nuestro catálogo NATURAL:
www.rocada.com/document/natural-2020.pdf

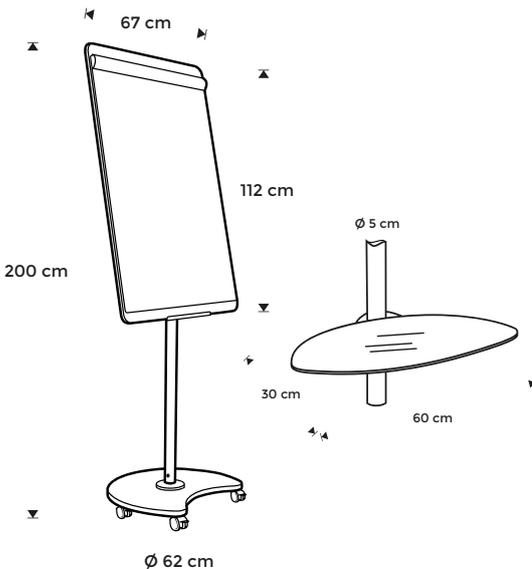

REF	PRODUCTO	MATERIAL	MEDIDAS
RD619	Bandeja de cristal	Cristal templado	60 x 30 cm
NAT0616	Pizarra lacada	Melamina / Acero	67 x 200 x 62 cm

*Medidas: Ancho x alto x fondo.

COMPLEMENTOS ADICIONALES PARA PIZZARRAS MÓVILES

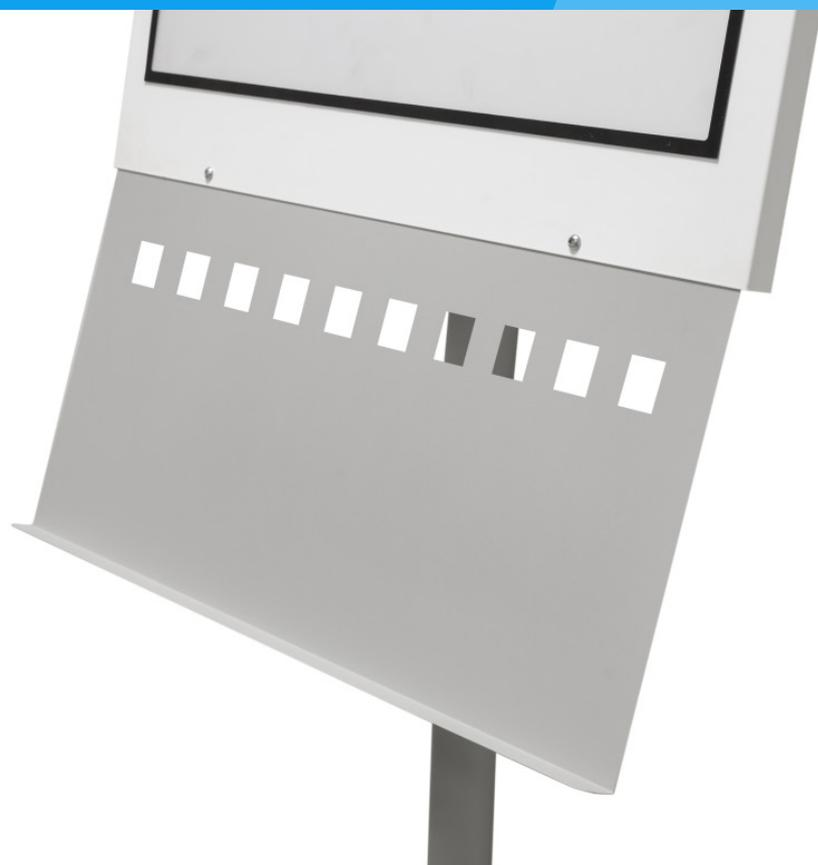

Pizarra móvil metálica y magnética, apta para escritura con rotuladores de borrado en seco. Admite bloc de papel universal. No regulable en altura. Incluye 1 brazo telescópico. Fácil montaje.

Bandeja metálica de fácil instalación para poder transformar una pizarra móvil en expositor y poder informar/señalizar en cualquier zona que lo requiera. La pizarra admite funda magnética RDS0703A1 tamaño A1 vertical.

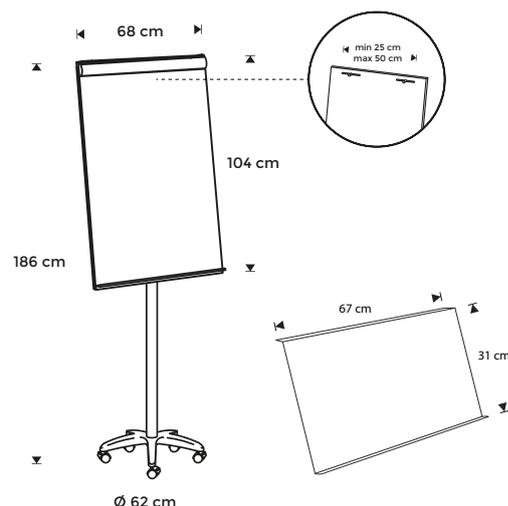

REF	PRODUCTO	MATERIAL	MEDIDAS
BS0616	Bandeja de acero	Acero	67 x 31 x 3 cm
RDS0301A1	Funda magnética	Acrílico	DIN A1
RD616	Pizarra lacada	Acero / Melamina	68 x 186 x 64 cm

*Medidas: Ancho x alto x fondo.

PANEL INFORMATIVO CON BANDEJA PARA DOSIFICADOR DE NUESTRA GAMA NATURAL

PANEL INFORMATIVO METÁLICO CON BANDEJA PARA DOSIFICADOR



COV-SIS1600
Acabado en madera.



Paneles informativos con fundas magnéticas incluidas.



COV-SIS1500

Nueva familia de paneles informativos regulables en altura pensados para una máxima adaptación en restaurantes, bares, comercios, lugares públicos... Gama que incluye desde soportes informativos con acabados que recuerdan la calidez de la madera, hasta paneles informativos pensados para utilizar en restaurantes y poder visualizar la carta de una forma segura y rápida. La bandeja (de 30 x 20 cm) es regulable en altura y permite colocar geles desinfectantes o guantes según la necesidad. Paneles informativos con fundas magnéticas incluidas.

REF	MATERIAL	TAMAÑO	MEDIDAS
COV-SIS1600	Acero / Melamina	DIN A4	40 x 102-150 x 30 cm
COV-SIS1500	Acero	DIN A4	30 x 102-150 x 30 cm

*Medidas: Ancho x alto x fondo.

PANEL INFORMATIVO METÁLICO REGULABLE EN ALTURA



Panel informativo con fundas magnéticas incluidas.



Superficie apta para la escritura con rotuladores de borrado en seco.

Panel informativo metálico regulable en altura con panel rotativo 360°.

Superficie metálica para fijar documentos en formato A3 o A4 mediante imanes y pintada en blanco para escribir directamente con rotuladores especiales para pizarra. Fácil montaje.

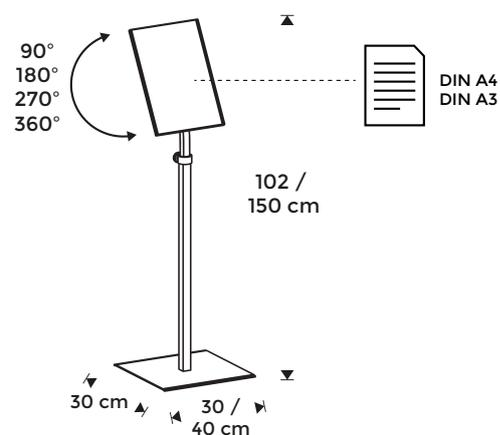

REF	TAMAÑO	MATERIAL	MEDIDAS
BS0705S	DIN A4	Acero	30 x 102-150 x 30 cm
BS0706S	DIN A3	Acero	40 x 102-150 x 30 cm

*Medidas: Ancho x alto x fondo.

PANEL INFORMATIVO METÁLICO DE DOBLE CARA TAMAÑO DIN A1

Ref. RDS0301A1
Protector acrílico imantado
no incluido.

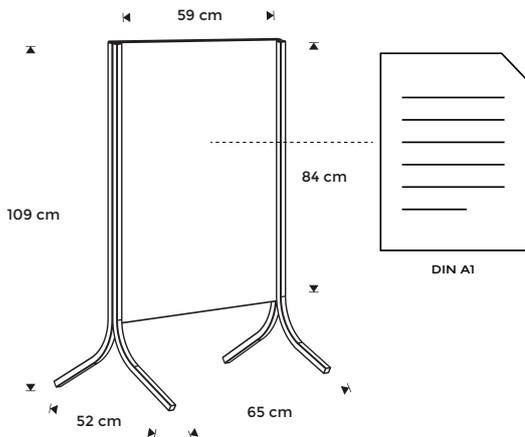

Panel informativo metálico de doble cara fabricado en blanco, apto para la escritura con rotuladores de borrado en seco.

La superficie del panel se adapta perfectamente con la funda magnética imantada de tamaño DIN A1, muy aconsejable para proteger la escritura o la fijación de información impresa. Fácil montaje.

REF	MATERIAL	TAMAÑO	MEDIDAS
RD8210	Acero	DIN A1	65 x 109 x 52 cm
RDS0301A1	Acrílico	DIN A1	59.5 x 84 cm

*Medidas: Ancho x alto x fondo.

POSTES DE CINTA RECTRÁCTIL



Ref. BS0771S
Accesorio
a pared.



Poste metálico con 2m de cinta retráctil extensible acabado en color negro, ideal para la gestión en colas o la separación de espacios. La altura del poste de más de 1 metro de alto permite su perfecta adaptación al entorno.

Accesorio de pared disponible para dar la mejor solución al espacio donde se utilice.

Las cintas se pueden personalizar en distintos colores diferentes bajo pedido.

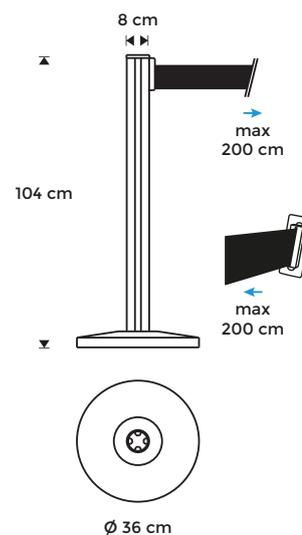

REF	PRODUCTO	MEDIDAS
BS0770S	Columna (2u)	36 x 104 x 36 cm
BS0771S	Accesorio a pared	-

*Medidas: Ancho x alto x fondo.

PAPELERAS CON PEDAL DE APERTURA

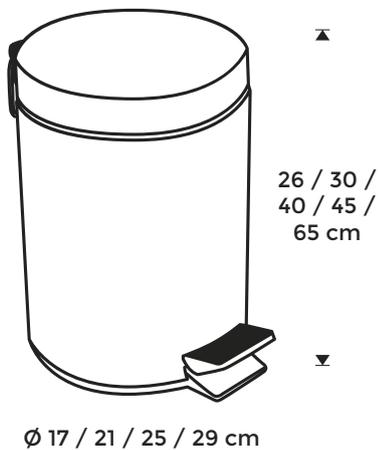
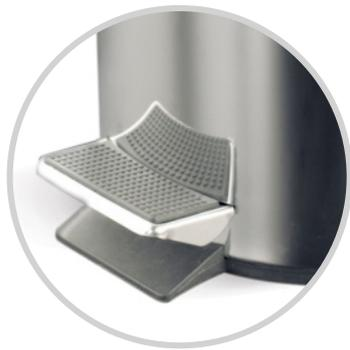

Papeleras de pedal redondas inox brillo, Incluye cubeta interior de polipropileno negro inyectado, completamente inerte ante productos de uso cotidiano e incluso de agentes químicos agresivos.

Tapa superior de cierre perimetral sobre la cubeta interior. Producto apropiado para baños de hoteles, restaurantes y colectividades.

REF	MATERIAL	CAPACIDAD	MEDIDAS
COV-BIN03	Inox	3 litros	17 x 26 x 17 cm
COV-BIN07	Inox	7 litros	21 x 30 x 21 cm
COV-BIN12	Inox	12 litros	25 x 40 x 25 cm
COV-BIN20	Inox	20 litros	29 x 45 x 29 cm
COV-BIN30	Inox	30 litros	29 x 65 x 29 cm

*Medidas: Ancho x alto x fondo.

DISPENSADORES A PARED Y SOPORTE DE PIE CON BANDEJA ADICIONAL

 **rocada**

NUEVO



COV-DISP850AUT



COV-DISP800AUT



COV-DISP1000

Dispensadores automáticos
(pilas tipo AA no incluidas).

Dispensador
manual.

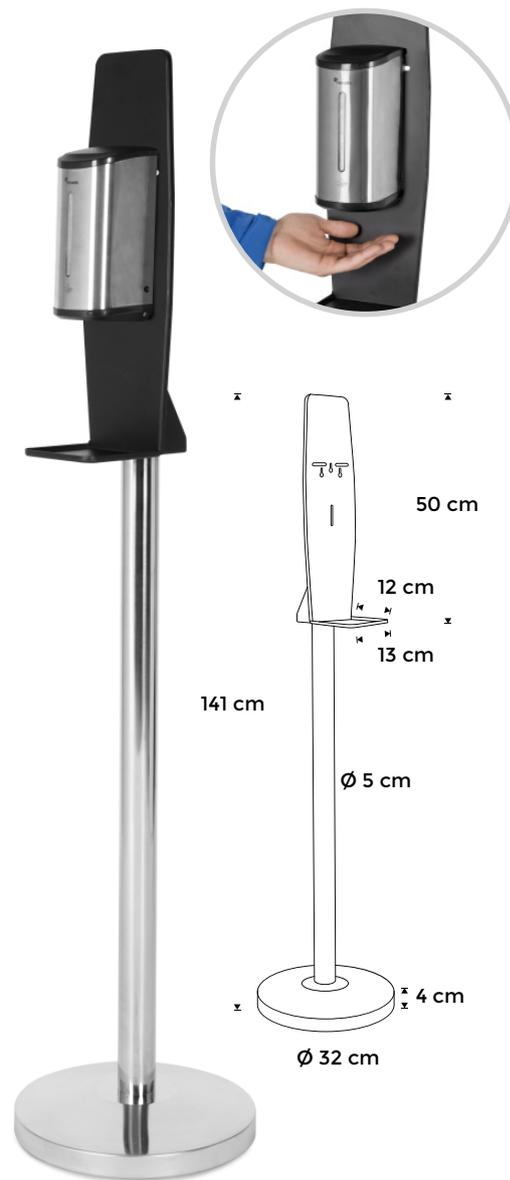
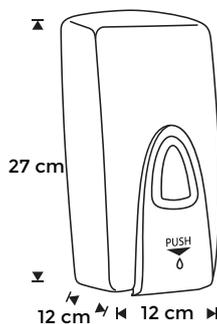
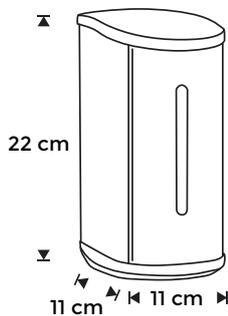
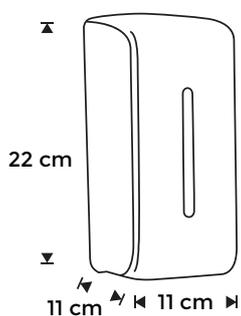

Dispensadores de pared con diferentes acabados para adaptarse a todo tipo de entornos (trabajo, tienda, museo, etc). Fácil instalación y mantenimiento. Incluye llave para la apertura y acceso al depósito y herrajes para la fijación a pared. 3 modelos a elegir. Posibilidad de complementar el dispensador con nuestro soporte de pie para dispensadores.

COV-DISPSTAND:

Soporte universal de pie para dispensadores de pared con acabado INOX. Bandeja adicional de 13 x 12 cm para evitar la suciedad de residuos en el suelo o para disponer de útiles de limpieza e higiene.

REF	MATERIAL	CAPACIDAD	TIPO	MEDIDAS
COV-DISP850AUT	Inox / Polímero técnico	0,85 litros	Automático	11 x 22 x 11 cm
COV-DISP800AUT	Polímero técnico	0,8 litros	Automático	11 x 22 x 11 cm
COV-DISP1000	Polímero técnico	1 litro	Manual	12 x 27 x 12 cm
COV-DISPSTAND	Inox / Polímero técnico	-	-	32 x 141 x 32 cm

*Medidas: Ancho x alto x fondo.

GEL HIDROALCOHÓLICO 1L



Gel hidroalcohólico de (1000 ml), para una limpieza exhaustiva y profunda de manos sin necesidad de agua. Ideal para recargar los dispensadores de pared y garantizar una máxima limpieza en cualquier establecimiento.

Disponible en packs de 12 unidades.

REF	MATERIAL	PACK	MEDIDAS
COV-GEL1L	Gel	1 litro + dosificador	9 x 27 x 4 cm
COV-GEL1LREC	Gel	1 litro	9 x 27 x 4 cm
COV-GEL1LREC*12	Gel	12 x 1 litro = 12 litros	9 x 27 x 4 cm

*Medidas: Ancho x alto x fondo.



rocada

Rocada HQ (Spain)
rocada@rocada.com
www.rocada.com

Rocada Deutschland GmbH
info@rocada.de
www.rocada.de

Rocada Japan LLC
info@rocada.co.jp





rocada

www.rocada.com
rocada@rocada.com



ISO 14001
BUREAU VERITAS
Certification



SKINWHITEBOARD

PIZARRAS MODULARES DE ALTA CALIDAD

SKINWHITEBOARD

EL SOPORTE IDEAL PARA SU CREATIVIDAD

Las pizarras modulares **SKINWHITEBOARD**, gracias a sus acabados, funciones y medidas le permiten potenciar y mimar la comunicación en todo momento.



Pizarras certificadas con la **certificación alemana GS**, reconocida a nivel mundial como una de las mejores certificaciones europeas en seguridad, calidad y continuidad de la fabricación del producto, dando al usuario una máxima seguridad y tranquilidad en su compra.





¿POR QUÉ

SKINWHITEBOARD?





AHORRA EN TIEMPO Y DINERO, GANA EN DISEÑO Y PRESTACIONES

Consigue en cada momento
la pizarra que necesita.

Descubre las ventajas que ofrecen
las pizarras modulares sin marco
y con fijación magnética.

SKINWHITEBOARD

VENTAJAS RESPECTO A LAS PIZARRAS CONVENCIONALES

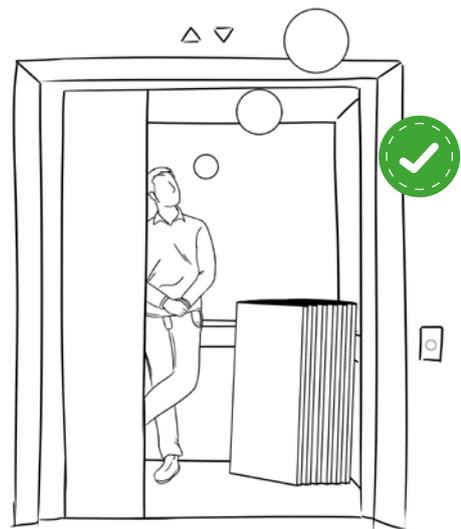
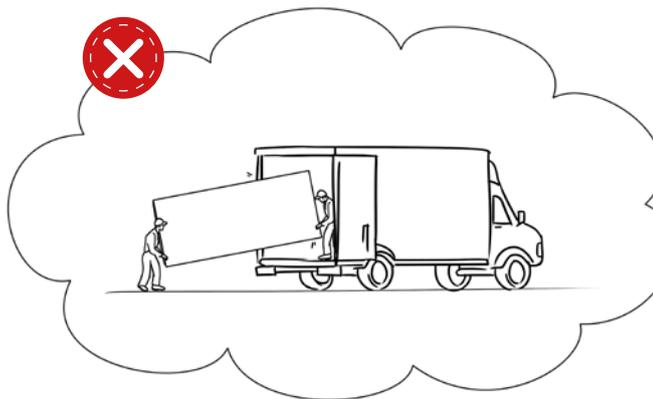

FÁCIL TRANSPORTE

Facilidad de transporte evitando incidencias, golpes y retrasos en los plazos de entrega, pudiendo transportar una pizarra de gran formato con cualquier vehículo de transporte.

FÁCIL ACCESO

No se requiere de transportes especiales, pudiendo transportarlas libremente con total comodidad.

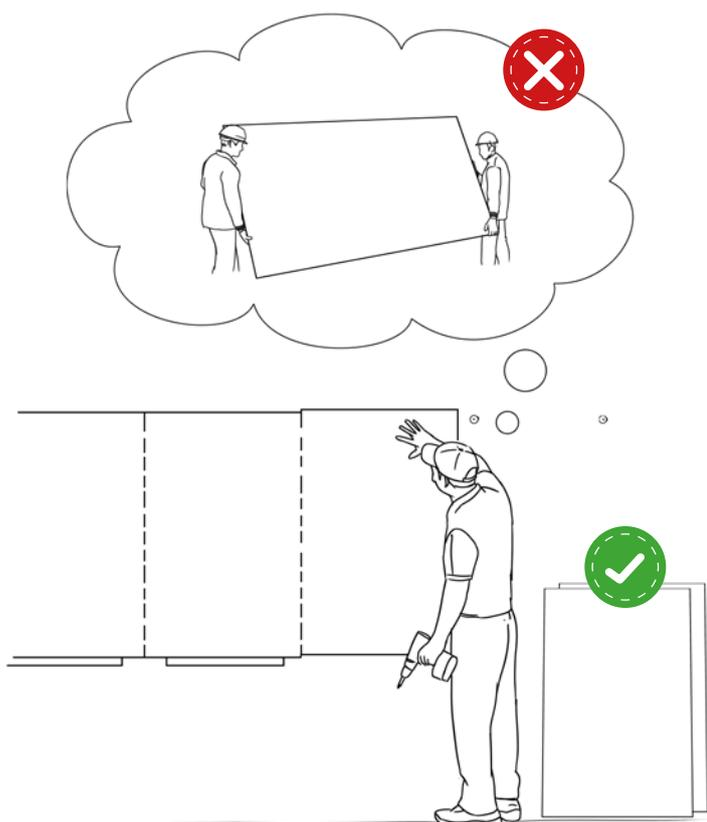

FÁCIL INSTALACIÓN

No se necesita más de una persona para moverlas e instalarlas, y su sistema de fijación imantado ofrece la máxima comodidad.



PIZARRA MODULAR

Infinidad de medidas y acabados para personalizar el espacio con diferentes superficies y funcionalidades. Infinitas combinaciones con múltiples posibilidades.

FÁCIL TRANSPORTE Y ACCESO

GRACIAS A SU MODULARIDAD





ALMACENAJES Y TRANSPORTES CÓMODOS Y SEGUROS

Sus características de **ligereza y modularidad**, ofrecen la posibilidad de ser transportadas fácilmente, adaptándose a cada situación y a cada método de transporte.

FÁCIL INSTALACIÓN

MÁXIMA SIMPLICIDAD Y COMODIDAD



Ver video de instalación
SKINWHITEBOARD:
<https://www.youtube.com/watch?v=bJkK0mfzgUA>



SISTEMA DE FIJACIÓN MÓDULO ÚNICO

Su facilidad y simplicidad en su sistema de montaje son únicos.



PRESENTACIÓN

NIVELACIÓN



MARCAJE / PERFORACIÓN



PREPARACIÓN DE ANCLAJES



FIJACIÓN



FÁCIL INSTALACIÓN

MÁXIMA SIMPLICIDAD Y COMODIDAD





Ver video de instalación
SKINWHITEBOARD:
[https://www.youtube.com/
watch?v=bJkK0mfzgUA](https://www.youtube.com/watch?v=bJkK0mfzgUA)

Sigue montando el resto de pizarras que formen la combinación final con la máxima facilidad que ofrece el sistema magnético.

COLOCACIÓN



ALINEACIÓN DE MÓDULOS

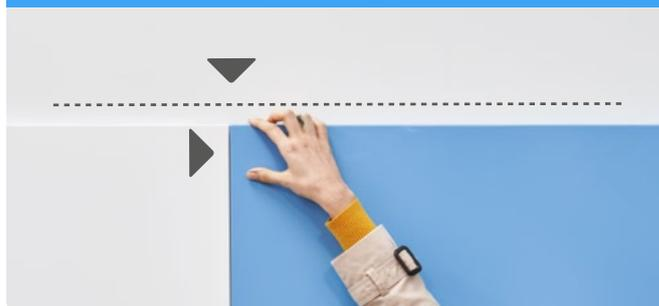

COLOCACIÓN DE LA BANDEJA



BLOQUEO DE MÓDULOS SELECCIONADOS



PIZARRA MODULAR

INFINITAS COMBINACIONES CON MÚLTIPLES POSIBILIDADES



3 MEDIDAS A ELEGIR:

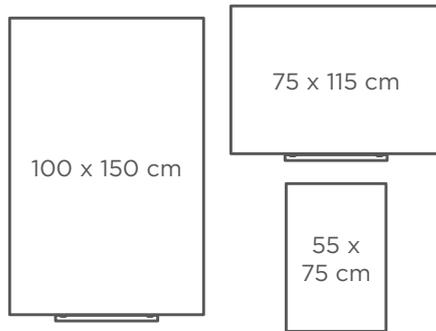

Gracias a su diseño sin marco y a sus diferentes tipos de funcionalidades y medidas, **SKINWHITEBOARD** le permite ajustar diferentes pizarras en un mismo espacio para conseguir una pizarra única y personalizarla con una gran variedad de acabados.

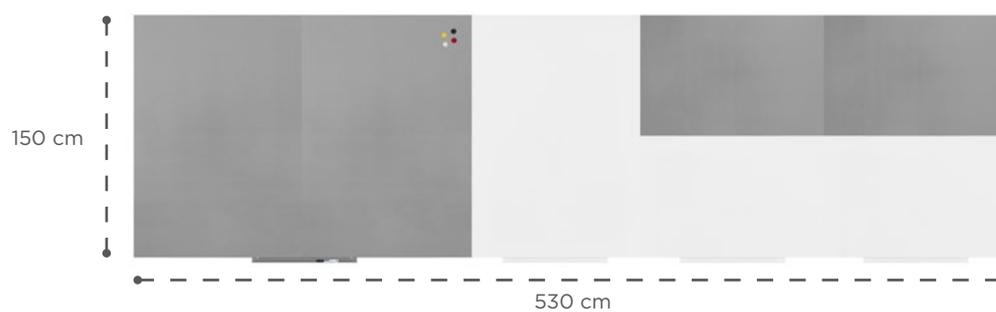
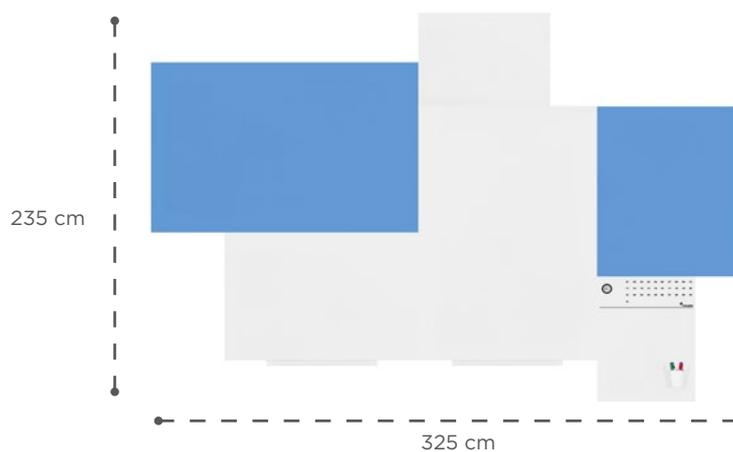
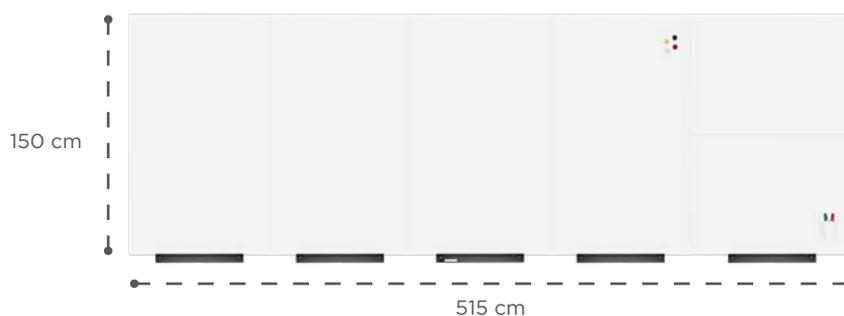

SKINWHITEBOARD

¿ARE YOU READY?

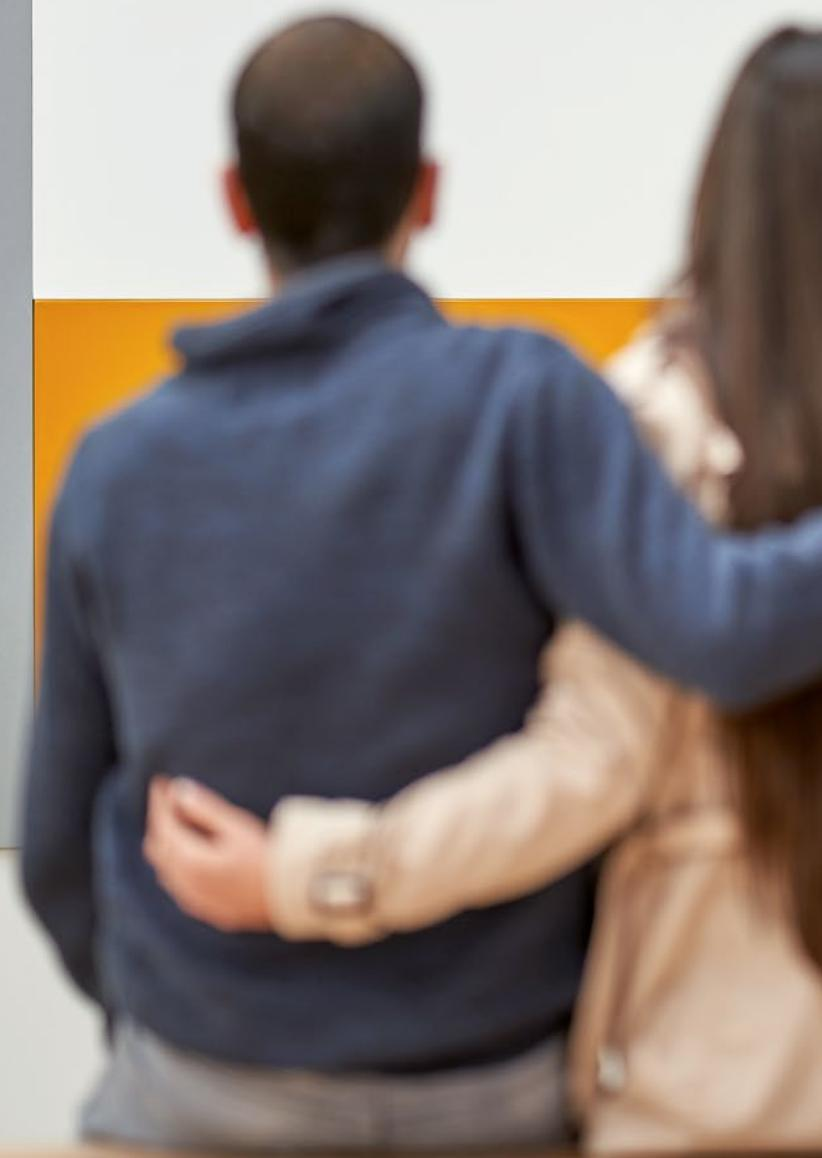

A continuación, le mostramos las diferentes pizarras que forman nuestra familia **SKINWHITEBOARD**. Diferentes modelos, medidas y acabados para una infinidad de composiciones.



SKINWHITEBOARD

LA MEJOR ELECCIÓN



SKINCERAMIC
(p. 20)

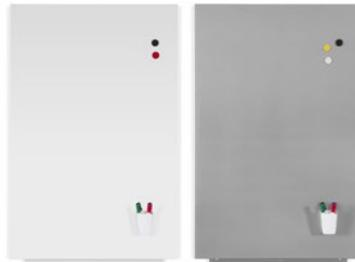

SKINPRO
(p. 24)



SKINCOLOUR
(p. 28)

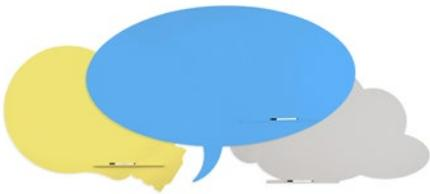

SKINSHAPE
(p. 32)



SKINMATT
(p. 36)

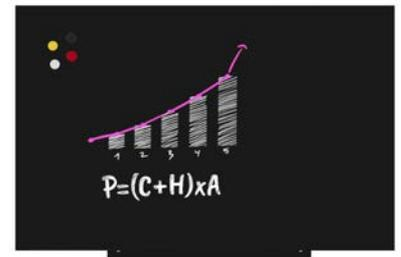

SKINLIQUID
(p. 38)



SKINAGILE
(p. 40)

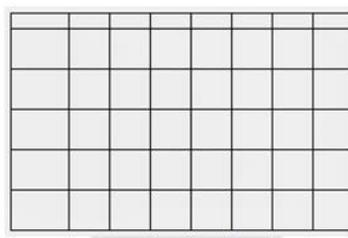

SKINPLANNER
(p. 42)



SKINMUSIC
(p. 44)



SKINCLOCK
(p. 46)



SKINMAP
(p. 48)



SKINPINBOARD
(p. 50)



SKINCUBE
(p. 52)



SKINSUPPORT
(p. 54)



SKINBLOCK
(p. 56)



SKINNYNOTES
(p. 58)

SKINCERAMIC

SUPERFICIE VITRIFICADA



T 1
25p
1p
15p
15p
35p
10p

TEST 1

- (A) Introduce yourself with a few lines.
- (B) Write down your future job.
- (C) Write down the present simple of the verb "to go"

- Complete this sentence:
- (D) "I used to play for ..."
 - (E) Make a brief review of listening 2.1.

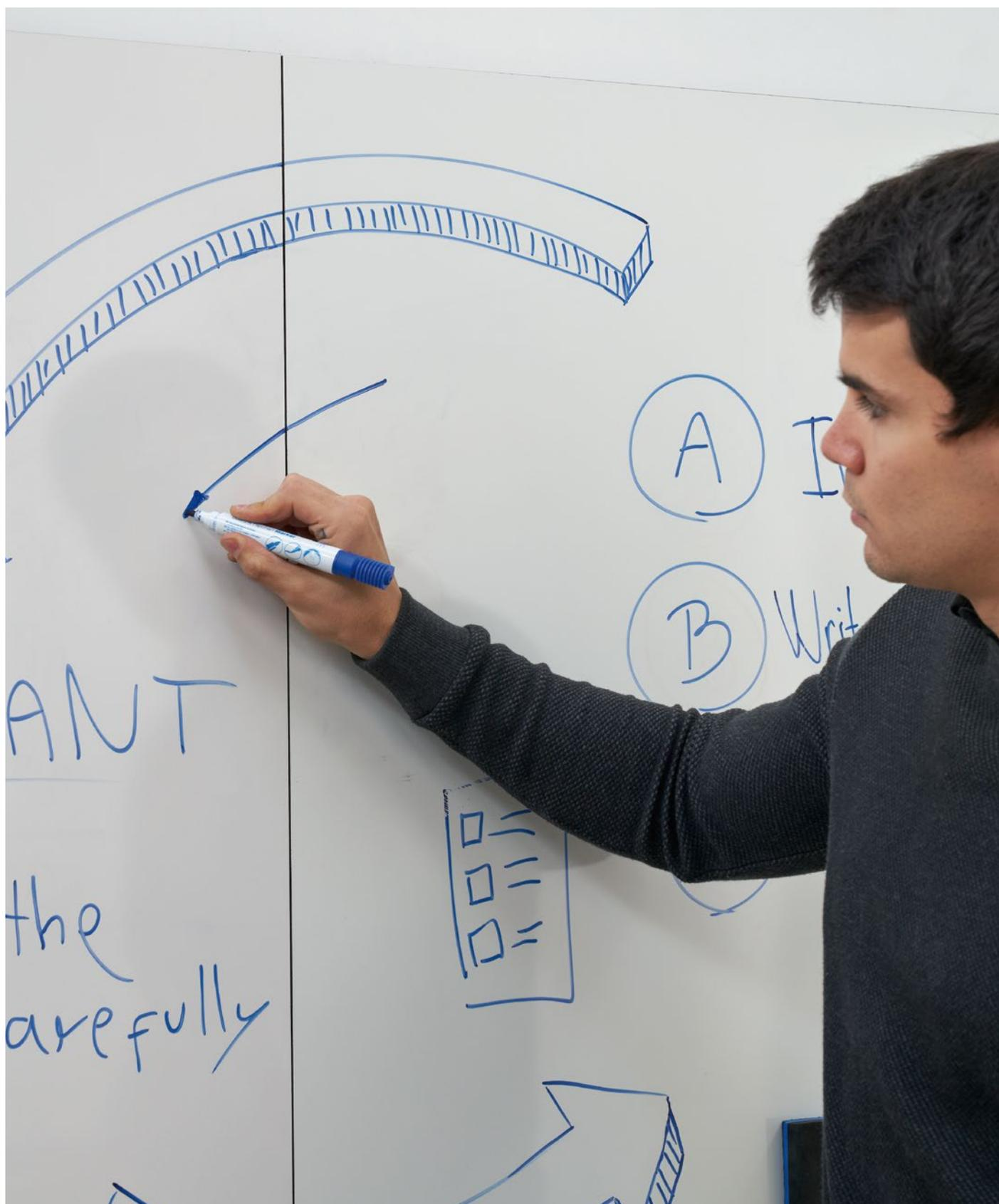

Pizarra modular con superficie vitrificada. **SkinCERAMIC** permite ser utilizada en los entornos con uso diario: escuelas, institutos, aulas de formación y salas de reuniones donde la escritura es intensiva.

Su superficie realizada en chapa de acero vitrificado permite una escritura diaria, con un mantenimiento mínimo y máxima garantía.



PRESENTACIÓN Y NIVELACIÓN

Plantilla de instalación para facilitar el montaje de las pizarras. Sistema de fijación imantada adaptado a las pizarras **SkinCERAMIC**, y sujeción atornillada de las bandejas para una mayor seguridad en zonas públicas.

PREPARACIÓN ANCLAJES



FIJACIÓN



COLOCACIÓN



BLOQUEO DE MÓDULOS SELECCIONADOS



ALINEACIÓN DE MÓDULOS

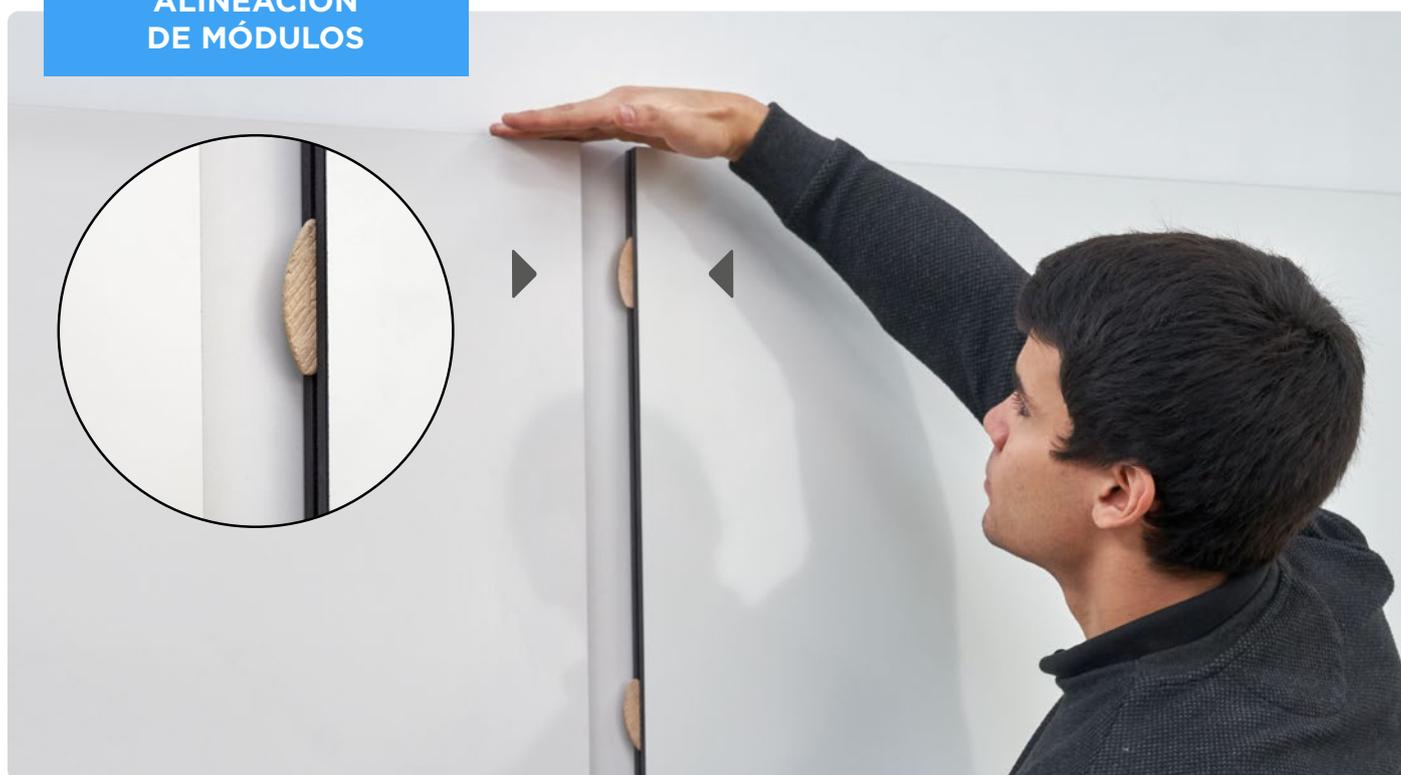

Sistema de auto alineado para ajustarse a las irregularidades que puedan presentar las paredes y tener siempre una superficie totalmente llana.



Rotulador de borrado en seco incluido.

COLOR DISPONIBLE



RAL 9003
blanco

CARACTERÍSTICAS TÉCNICAS

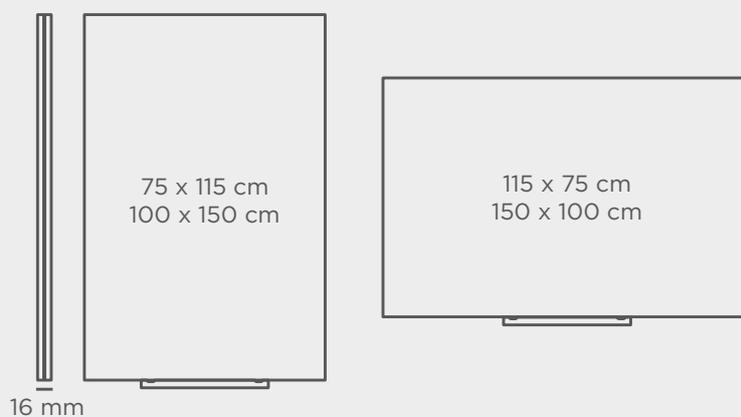

REFERENCIA	COLOR	SUPERFICIE	EMBALAJE
6620CER	Blanco	75 x 115 cm	124 x 84 x 4 cm / 0,041 m ³ / 9,50 Kg
6621CER	Blanco	100 x 150 cm	159 x 109 x 4 cm / 0,069 m ³ / 18,50 Kg

Superficie: ancho x alto.

SKINPRO



*Consultar modelos

SUPERFICIE LACADA CON PROTECCIÓN ADICIONAL





La pizarra **SkinPRO** gracias a su nuevo acabado especial con protección adicional de la superficie realizado en material polimérico (PET) permite ser utilizada en los entornos donde es

frecuente la escritura y su utilización. Su superficie permite una escritura continua con un mantenimiento mínimo y con una máxima garantía.



SkinPRO es una perfecta elección para aquellos que buscan calidad y un buen precio en una pizarra.



Rotulador de borrado en seco incluido.

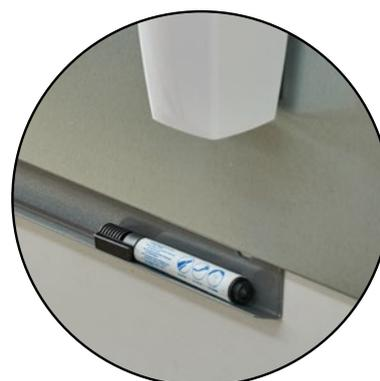

Posibilidad de atornillar las bandejas para mayor seguridad.

COLORES DISPONIBLES



RAL 9003
blanco

RAL 9006
gris plata

CARACTERÍSTICAS TÉCNICAS

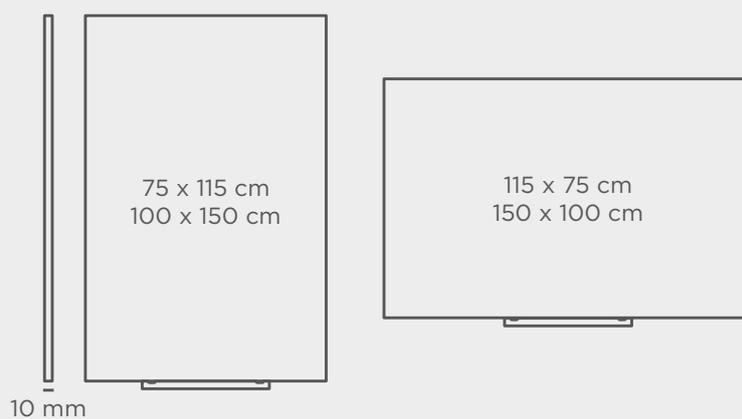

REFERENCIA	COLOR	SUPERFICIE	EMBALAJE
6520PRO	Blanco	75 x 115 cm	124 x 84 x 3 cm / 0,031 m ³ / 8,15 Kg
6520PRO-9006	Gris plata	75 x 115 cm	159 x 109 x 3 cm / 0,052 m ³ / 16,10 Kg
6521PRO	Blanco	100 x 150 cm	124 x 84 x 3 cm / 0,031 m ³ / 8,15 Kg
6521PRO-9006	Gris plata	100 x 150 cm	159 x 109 x 3 cm / 0,052 m ³ / 16,10 Kg

Superficie: ancho x alto.

SKINCOLOUR

SUPERFICIE LACADA



*Consultar modelos

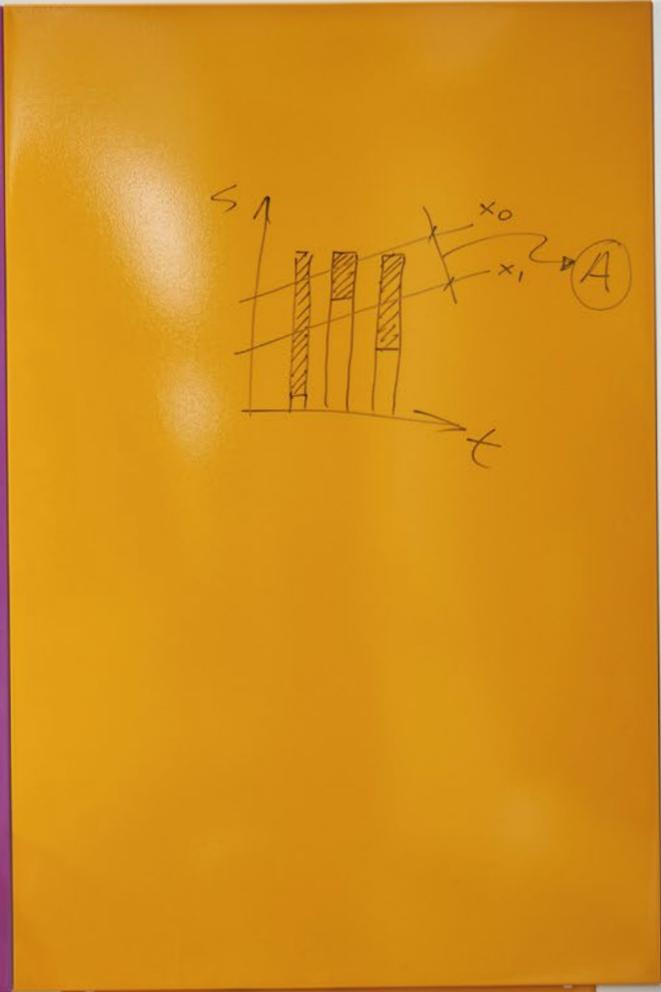



Gracias su variedad cromática, **SkinCOLOUR** te permite ordenar las tareas por colores y personalizar los departamentos de tu empresa, mejorar la visualización de la información, etc. Los diferentes acabados totalmente

compatibles con los rotuladores de borrado en seco, combinan perfectamente con todo tipo de entornos y además darán un toque moderno y fresco a su oficina.



Superficie lacada disponible en múltiples acabados. Personaliza su oficina según sus necesidades.



Rotulador de borrado en seco incluido.



Superficies compatibles con rotuladores de borrado en seco. Permite la escritura con rotuladores de tiza líquida.



Posibilidad de atornillar las bandejas para mayor seguridad.

COLORES DISPONIBLES

RAL 9003 blanco	RAL 1013 amarillo perla	RAL 1015 amarillo claro	RAL 1016 amarillo azufre	RAL 1023 amarillo tráfico	RAL 2008 naranja	RAL 2002 rojo bermejo
RAL 3002 rojo carmín	RAL 3014 rosa oscuro	RAL 3015 rosa amaranto	RAL 490 rosa	RAL 3012 rojo beige	RAL 4005 lila	RAL 5021 azul agua
RAL 5017 azul tráfico	RAL 5024 azul pastel	RAL 630 azul	RAL 6027 turquesa	RAL 6019 verde luminoso	RAL 230 verde	RAL 6018 verde amarillento
RAL 7035 gris luminoso	RAL 7038 gris Ágata	RAL 7030 gris piedra	RAL 7033 gris cemento	RAL 7039 gris cuarzo		

Acabados **BAJO PEDIDO**

CARACTERÍSTICAS TÉCNICAS

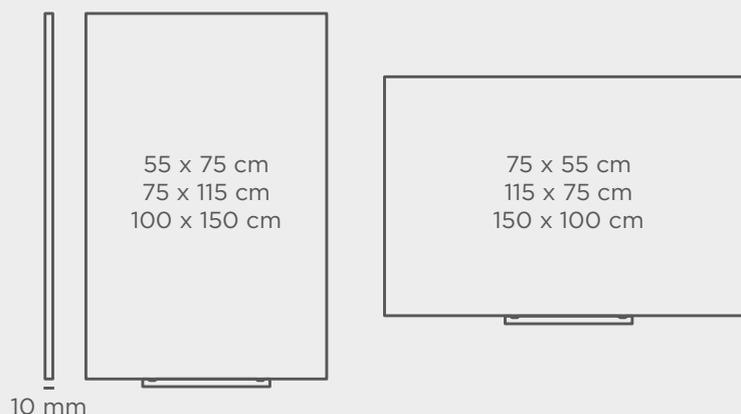

REFERENCIA	COLOR	SUPERFICIE	EMBALAJE
6419R	Blanco	55 x 75 cm	124 x 84 x 3 cm / 0,031 m ³ / 8,15 Kg
6419R-COLOR	A elegir	55 x 75 cm	83 x 63 x 3 cm / 0,016 m ³ / 4,40 Kg
6420R	Blanco	75 x 115 cm	124 x 84 x 3 cm / 0,031 m ³ / 8,15 Kg
6420R-COLOR	A elegir	75 x 115 cm	159 x 109 x 3 cm / 0,052 m ³ / 16,10 Kg
6421R	Blanco	100 x 150 cm	124 x 84 x 3 cm / 0,031 m ³ / 8,15 Kg
6421R-COLOR	A elegir	100 x 150 cm	159 x 109 x 3 cm / 0,052 m ³ / 16,10 Kg

Superficie: ancho x alto / Plazo de preparación de los acabados bajo pedido entre 5 y 10 días laborables.

SKINSHAPE

SUPERFICIE LACADA





Las pizarras **SkinSHAPE** son pizarras metálicas, magnéticas, sin marco y con 3 innovadores formas a elegir:

- **SkinTALK**: con forma de diálogo
- **SkinCLOUD**: con forma de nube
- **SkinIDEA**: con forma de bombilla

Superficie lacada apta para rotuladores de borrado en seco. Disponible en 2 medidas diferentes y múltiples colores.

3 MODELOS A ELEGIR:

Porque tus formas deben comunicar mensajes según sus necesidades.

SkinSHAPE te permite orientar de forma muy gráfica el uso de la pizarra al que quieres dirigirte gracias a su forma perimetral.

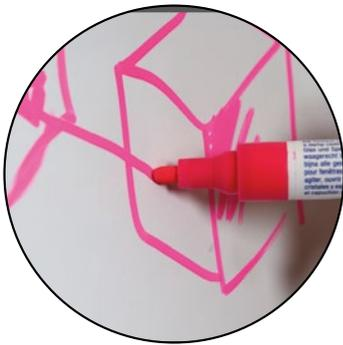

Superficies compatibles con rotuladores de borrado en seco. Permite la escritura con rotuladores de tiza líquida.



Rotulador de borrado en seco incluido.

SKINTALK



SKINCLOUD



SKINIDEA

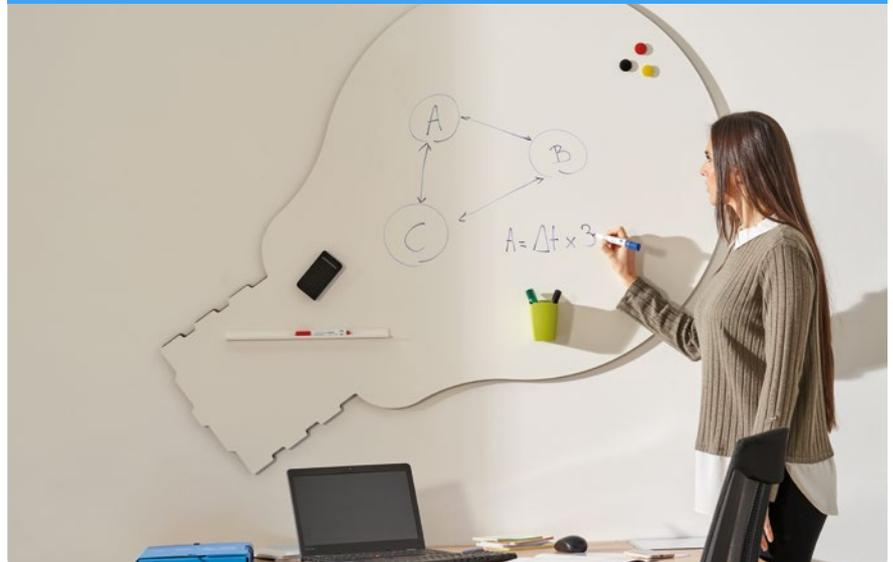



Bandeja imantada incluida, para poder colocarla en la zona de la pizarra que más desee.

COLORES DISPONIBLES

RAL 9003 blanco	RAL 1013 amarillo perla	RAL 1015 amarillo claro	RAL 1016 amarillo azufre	RAL 1023 amarillo tráfico	RAL 2008 naranja	RAL 2002 rojo bermejo
RAL 3002 rojo carmín	RAL 3014 rosa oscuro	RAL 3015 rosa amaranto	RAL 490 rosa	RAL 3012 rojo beige	RAL 4005 lila	RAL 5021 azul agua
RAL 5017 azul tráfico	RAL 5024 azul pastel	RAL 630 azul	RAL 6027 turquesa	RAL 6019 verde luminoso	RAL 230 verde	RAL 6018 verde amarillento
RAL 7035 gris luminoso	RAL 7038 gris Ágata	RAL 7030 gris piedra	RAL 7033 gris cemento	RAL 7039 gris cuarzo		

! Acabados **BAJO PEDIDO**

CARACTERÍSTICAS TÉCNICAS



TALK
75 x 115 cm
100 x 150 cm



CLOUD
75 x 115 cm
100 x 150 cm



IDEA
75 x 115 cm
100 x 150 cm

REFERENCIA	TIPO	SUPERFICIE	EMBALAJE
6440-COLOR	TALK	75 x 115 cm	124 x 84 x 3 cm / 0,031 m ³ / 8,15 Kg
6441-COLOR	TALK	100 x 150 cm	159 x 109 x 3 cm / 0,052 m ³ / 16,10 Kg
6450-COLOR	CLOUD	75 x 115 cm	124 x 84 x 3 cm / 0,031 m ³ / 8,15 Kg
6451-COLOR	CLOUD	100 x 150 cm	159 x 109 x 3 cm / 0,052 m ³ / 16,10 Kg
6460-COLOR	IDEA	75 x 115 cm	124 x 84 x 3 cm / 0,031 m ³ / 8,15 Kg
6461-COLOR	IDEA	100 x 150 cm	159 x 109 x 3 cm / 0,052 m ³ / 16,10 Kg

Superficie: ancho x alto / Plazo de preparación de los acabados bajo pedido entre 5 y 10 días laborables.

SKINMATT

SUPERFICIE LACADA MATE

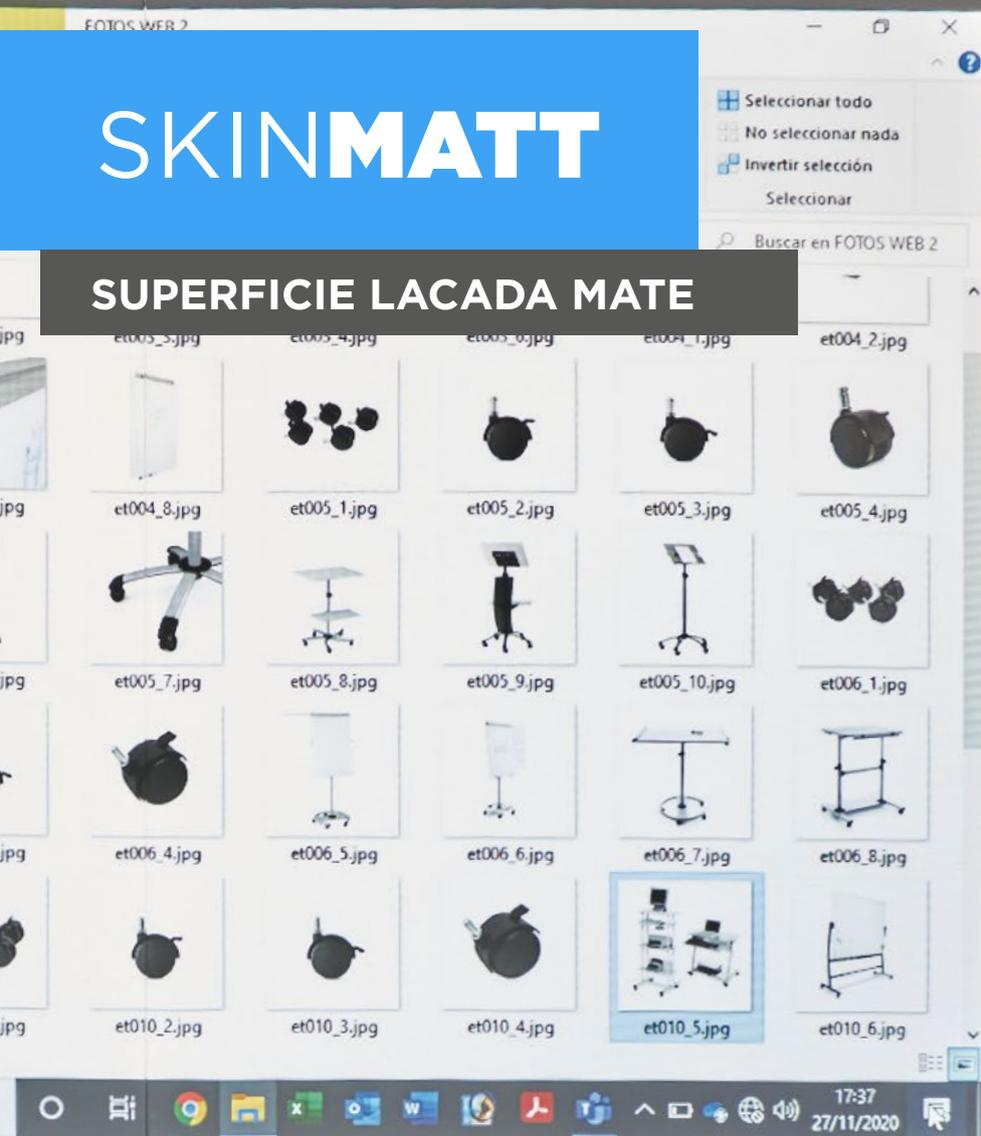

La pizarra **SkinMATT** se adapta perfectamente al formato de proyección 4:3, pudiendo crear una imagen de tamaño un 25% más grande que con las pizarras mate convencionales cuya altura máxima es tan sólo de 120 cm.

Ejemplo:



SkinMATT



PIZARRA CONVENCIONAL



Mejora tus presentaciones con la pizarra **SkinMATT**. Gracias a su nuevo acabado mate, permite ser utilizadas como pantalla de proyección para video proyectores, además de ser una pizarra totalmente compatible con los rotuladores de borrado en seco. El acabado de su superficie ofrece un borrado fácil y un mantenimiento muy efectivo gracias a su tolerancia al alcohol en sus procesos de limpieza.

Bandeja con sistema "click". Posibilidad de atornillar las bandejas para una mayor seguridad en zonas públicas.

Bandeja portaútiles y rotulador de borrado en seco incluido.



COLOR DISPONIBLE



RAL 9003
blanco mate

CARACTERÍSTICAS TÉCNICAS

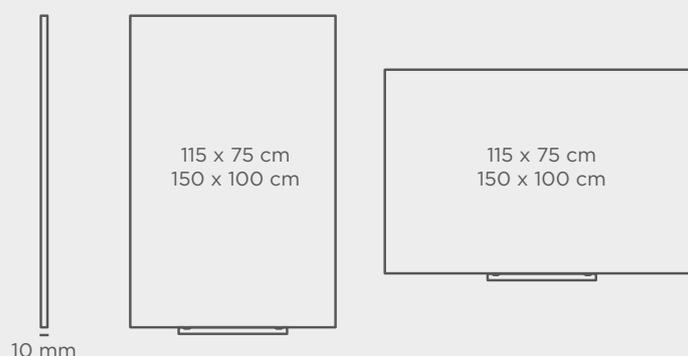

REFERENCIA	COLOR	SUPERFICIE	EMBALAJE
6420MATT	Blanco mate	75 x 115 cm	124 x 84 x 3 cm / 0,031 m ³ / 8,15 Kg
6421MATT	Blanco mate	100 x 150 cm	159 x 109 x 3 cm / 0,052 m ³ / 16,10 Kg

Superficie: ancho x alto.

SKINLIQUID

SUPERFICIE LACADA COLOR NEGRO

WIFI

#23@TA

Take Your Time



Bandeja portaútiles
y rotulador de
borrado en seco
incluido.

Su acabado lacado, magnético y de color negro permite a la pizarra **SkinLIQUID** ser utilizada con rotuladores de tiza líquida. Ideal para zonas donde su escritura no es frecuente y la información sea muy importante.

Su excelente modularidad permite crear todo tipo de configuraciones acorde a las necesidades actuales en sus espacios de trabajo.

Bandeja con sistema "click". Posibilidad de atornillar las bandejas para una mayor seguridad en zonas públicas.

COLOR DISPONIBLE



RAL 9005
negro

CARACTERÍSTICAS TÉCNICAS

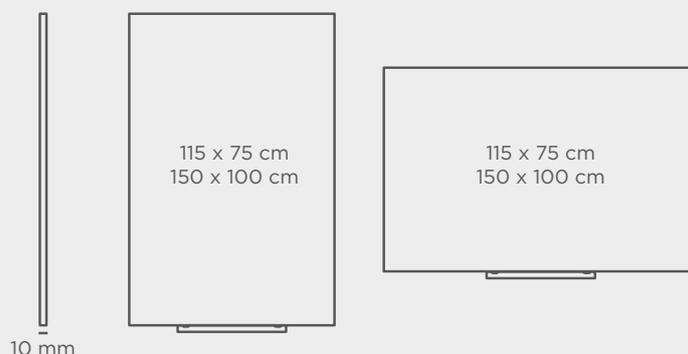

REFERENCIA	COLOR	SUPERFICIE	EMBALAJE
6820V19	Negro	75 x 115 cm	124 x 84 x 3 cm / 0,031 m ³ / 8,15 Kg
6821V19	Negro	100 x 150 cm	159 x 109 x 3 cm / 0,052 m ³ / 16,10 Kg

Superficie: ancho x alto.

SKINAGILE

SUPERFICIE LACADA CON COLUMNAS





Bandeja portaútiles y rotulador de borrado en seco incluido.

La pizarra **SkinAGILE** está pensada para ser un cuadro de control y de organización, potenciar la eficiencia en un equipo de trabajo y aplicar diferentes metodologías de trabajo para el desarrollo de proyectos que precisan rapidez y flexibilidad.

Informar, ver e identificar en qué estado se encuentran las tareas pendientes de una forma más fácil y más cómoda.

Bandeja con sistema "click". Posibilidad de atornillar las bandejas para una mayor seguridad en zonas públicas.

COLOR DISPONIBLE



RAL 9003
blanco

CARACTERÍSTICAS TÉCNICAS

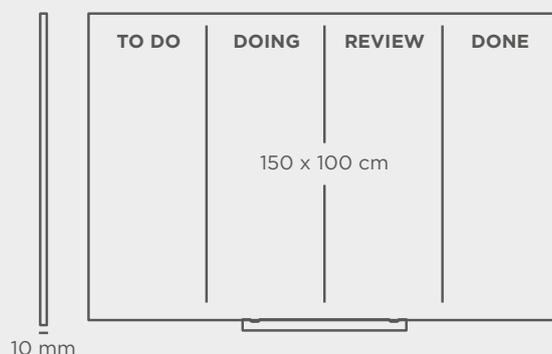

REFERENCIA

SUPERFICIE

EMBALAJE

6421AG

150 x 100 cm

159 x 109 x 3 cm / 0,052 m³ / 16,10 Kg

Superficie: ancho x alto.

SKINPLANNER

SUPERFICIE LACADA CON CUADRÍCULA





Bandeja portaútiles y rotulador de borrado en seco incluido.

Las pizarras **SkinPLANNER** están especialmente preparadas para planificar sus reuniones, sus presentaciones, visitas, etc. Distribución anual de serie y otra versión totalmente personalizable gracias a su plantilla en 4 idiomas, con múltiples opciones:

- números
- días de la semana
- estados de los procesos

.....
Pizarra totalmente compatible con los rotuladores de borrado en seco.

Bandeja con sistema "click". Posibilidad de atornillar las bandejas para una mayor seguridad en zonas públicas.

COLOR DISPONIBLE



RAL 9003
blanco

CARACTERÍSTICAS TÉCNICAS

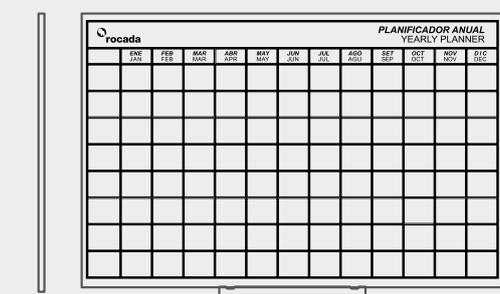

6420YP
115 x 75 cm

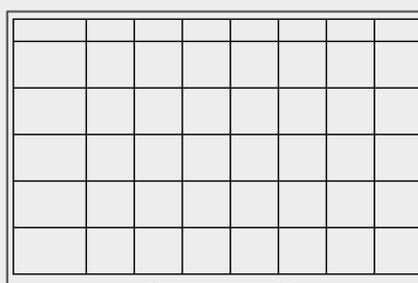

6420UP
115 x 75 cm

Plantilla adhesiva

rocada		Universal skin planner	
MONDAY	MONTAG	LUNDI	LUNES
TUESDAY	DIENSTAG	MARDI	MARTES
WEDNESDAY	MITTWOCH	MERCREDI	MIÉRCOLES
THURSDAY	DONNERSTAG	JEUDI	JUEVES
FRIDAY	FREITAG	VENDREDI	VIERNES
SATURDAY	SAMSTAG	SAMEDI	SABADO
SUNDAY	SONNTAG	DIMANCHE	DOMINGO
WEEK	WOCHE	SEMAINE	SEMANA
DAY	TAG	JOUR	DIA
1	2	3	4
5	6	7	8
PROJECT	TO DO	PRIO	SPRINT
TASK	TO DO	PRIO	SPRINT
PROJECT	DONE	BLOCKED	IN PROGRESS
TASK	DONE	BLOCKED	IN PROGRESS
PRODUCT	STORY	NEXT	SPRINT
BACKLOG	STORY	NEXT	BACKLOG
PRODUCT	IN TEST	REVIEW	SPRINT
BACKLOG	IN TEST	REVIEW	BACKLOG

REFERENCIA

SUPERFICIE

TIPO

EMBALAJE

6420YP

115 x 75 cm

Cuadrícula mensual

124 x 84 x 3 cm / 0,031 m³ / 8,15 Kg

6420UP

115 x 75 cm

Cuadrícula genérica

124 x 84 x 3 cm / 0,031 m³ / 8,15 Kg

Superficie: ancho x alto.

SKINMUSIC

SUPERFICIE LACADA CON PENTAGRAMAS



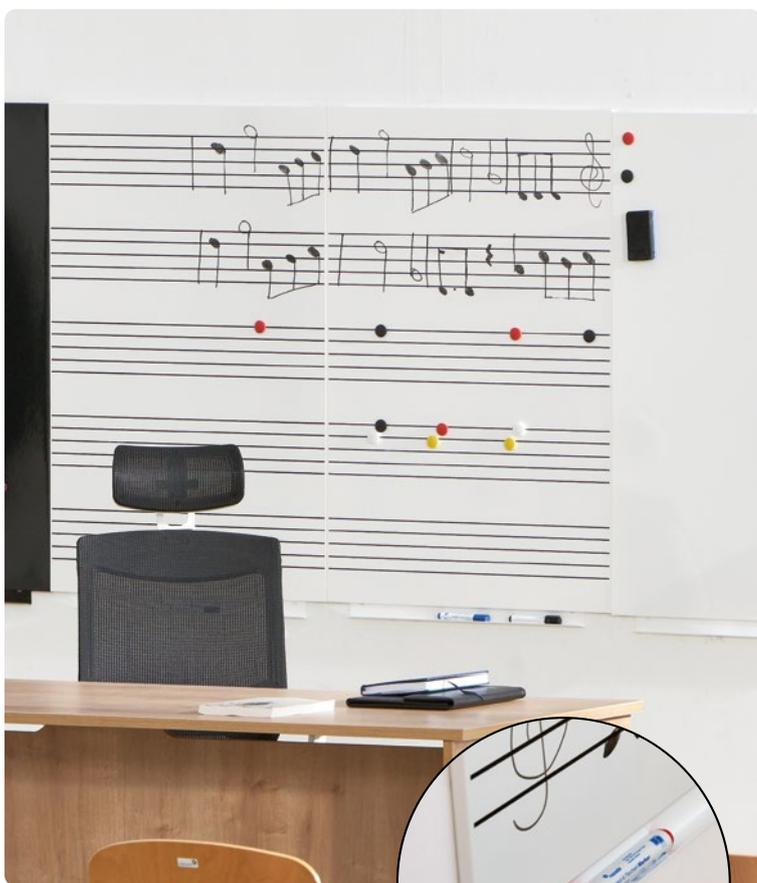

Bandeja portaútiles y rotulador de borrado en seco incluido.

Gracias a su acabado lacado con pentagrama y a la modularidad del sistema Skin, convierten a la **SkinMUSIC** en una de las mejores herramientas para el estudio y la creación de todo tipo de música.

Su acabado con pentagrama es totalmente compatible con los rotuladores de borrado en seco. Disponible en 3 modelos diferentes.

Bandeja con sistema "click". Posibilidad de atornillar las bandejas para una mayor seguridad en zonas públicas.

COLOR DISPONIBLE



RAL 9003
blanco

CARACTERÍSTICAS TÉCNICAS

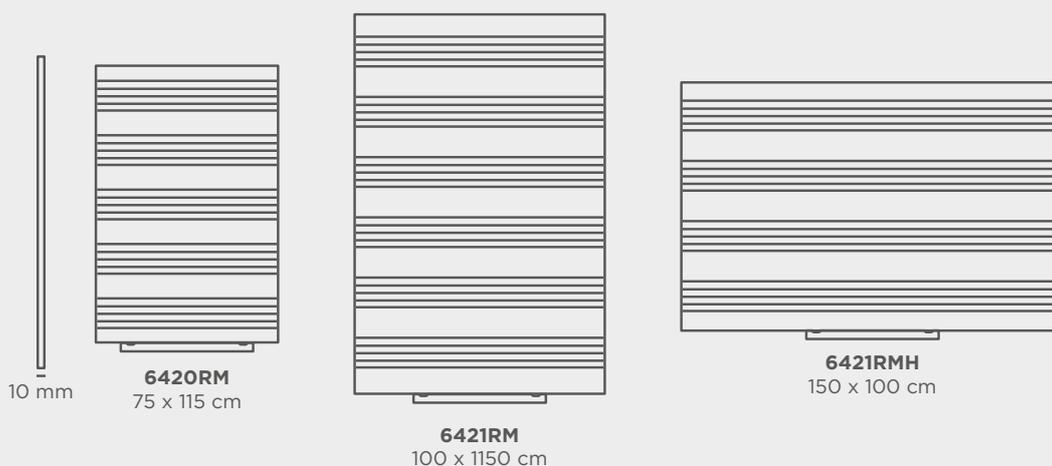

REFERENCIA	SUPERFICIE	Nº PENTAGRAMAS	EMBALAJE
6420RM	75 x 115 cm	5	124 x 84 x 3 cm / 0,031 m ³ / 8,15 Kg
6421RM	100 x 150 cm	6	159 x 109 x 3 cm / 0,052 m ³ / 16,10 Kg
6421RMH	150 x 100 cm	4	159 x 109 x 3 cm / 0,052 m ³ / 16,10 Kg

Superficie: ancho x alto.

SKINCLOCK

SUPERFICIE LACADA CON RELOJ Y CALENDARIO





La **SkinLOCK** es su pizarra metálica y magnética con superficie lacada perfecta para ayudarle a planificar y organizar todo tipo de tareas.

Su acabado es totalmente compatible con los rotuladores de borrado en seco. Incluye calendario y reloj analógico de serie en la parte superior. Recomendada para la organización de su oficina y la planificación en su vida familiar.

Bandeja con sistema "click". Posibilidad de atornillar las bandejas para una mayor seguridad en zonas públicas.

Bandeja portaútiles incluida. Viene equipada de serie con reloj y calendario.



COLOR DISPONIBLE



RAL 9003
blanco

CARACTERÍSTICAS TÉCNICAS

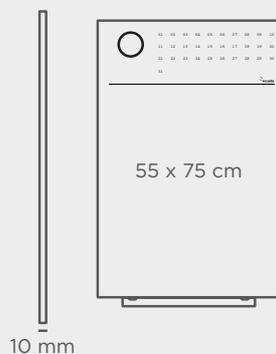

REFERENCIA	SUPERFICIE	EMBALAJE
6419CL	55 x 75 cm	159 x 109 x 3 cm / 0,052 m ³ / 16,10 Kg

Superficie: ancho x alto.

SKINMAP

SUPERFICIE VINILIZADA CON MAPA



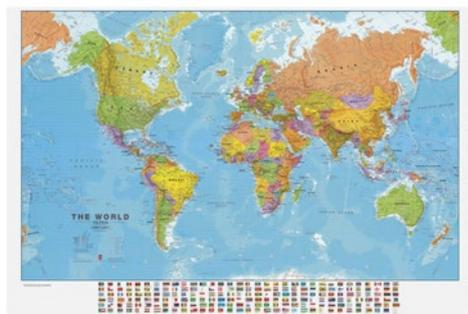

6421MAPWD



6421MAPUE



6421MAPSP

Las pizarras **SkinMAP** son pizarras metálicas, magnéticas y sin marco especialmente preparadas para ilustrar y trabajar entorno a los mapas.

Toda la superficie de la pizarra admite la fijación de imanes u otros accesorios magnéticos, y es totalmente compatible con los rotuladores de borrado en seco. Disponible según modelo con el mapa de España, Europa y el mundo.

Bandeja con sistema “click”. Posibilidad de atornillar las bandejas para una mayor seguridad en zonas públicas.



Bandeja portaútiles y rotulador de borrado en seco incluido.

COLOR DISPONIBLE



RAL 9003
blanco

CARACTERÍSTICAS TÉCNICAS

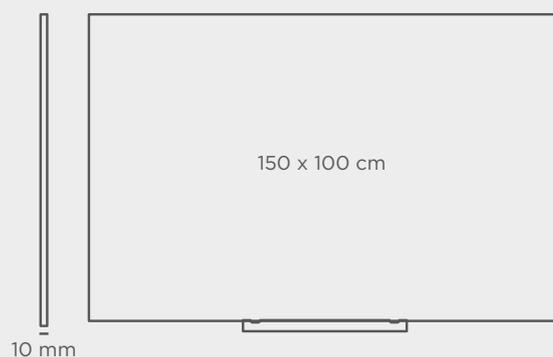

REFERENCIA	SUPERFICIE	TIPO	EMBALAJE
6421MAPWD	150 x 100 cm	Mapa del mundo	159 x 109 x 3 cm / 0,052 m ³ / 16,10 Kg
6421MAPUE	150 x 100 cm	Mapa de Europa	159 x 109 x 3 cm / 0,052 m ³ / 16,10 Kg
6421MAPSP	150 x 100 cm	Mapa de España	159 x 109 x 3 cm / 0,052 m ³ / 16,10 Kg

Superficie: ancho x alto.

 rocada

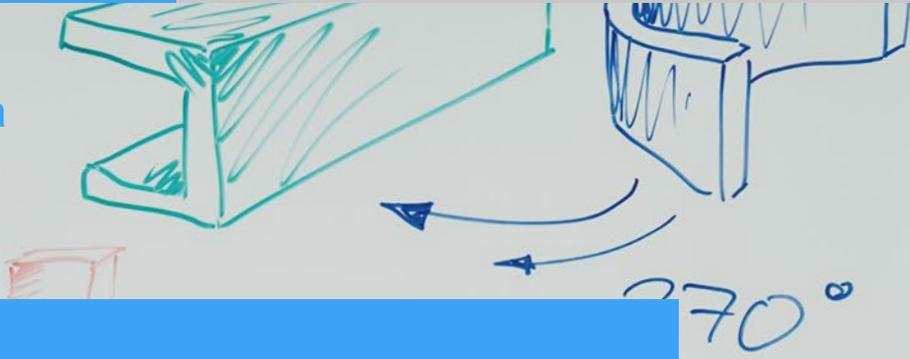

SKINPINBOARD

SUPERFICIE TAPIZADA





Fijación del panel mediante platinas con sistema de velcro. Fácil instalación.



SkinPINBOARD es un panel modular sin marco y tapizado, diseñado para la fijación de documentos mediante chinchetas u otros elementos de sujeción. Su diseño moderno permite colocarlas en vertical y horizontal para generar múltiples combinaciones. Disponible en 6 colores diferentes según modelo, con una fácil instalación ahorrando tiempo y dinero.

COLORES DISPONIBLES



0
tapizado gris



2
tapizado azul



510
tapizado verde



512
tapizado turquesa



518
tapizado marrón



523
tapizado naranja

CARACTERÍSTICAS TÉCNICAS

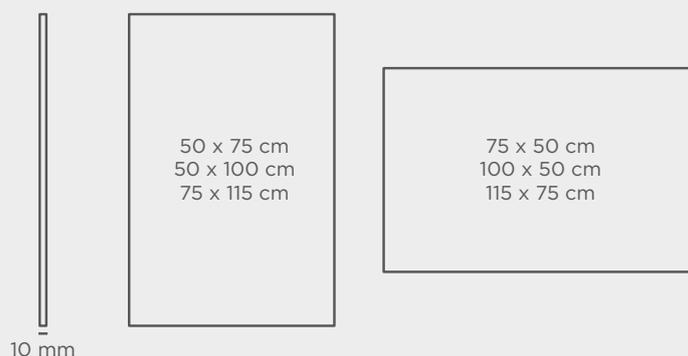

REFERENCIA	SUPERFICIE	EMBALAJE
6249-COLOR	50 x 75 cm	83 x 63 x 3 cm / 0,016 m ³ / 2,00 Kg
6248-COLOR	50 x 100 cm	109 x 59 x 3 cm / 0,019 m ³ / 3,00 Kg
6250-COLOR	75 x 115 cm	124 x 84 x 3 cm / 0,031 m ³ / 3,00Kg

Superficie: ancho x alto.

SKINCUBE

PIZARRA MÓVIL CON 4 SUPERFICIES





Ruedas de diseño para todo tipo de superficies.

El intercambio de información requiere soluciones de gestión visual (visual management) que se actualizan tan rápido y eficientemente como sea posible.

SkinCUBE nace con esta idea. 4 caras fabricadas con chapa de acero lacadas y magnéticas compatibles con rotuladores de borrado en seco. Realizado con una estructura interior en DM sobre ruedas de diseño y de gran resistencia para su desplazamiento y movilidad.

COLOR DISPONIBLE



RAL 9003
blanco

CARACTERÍSTICAS TÉCNICAS

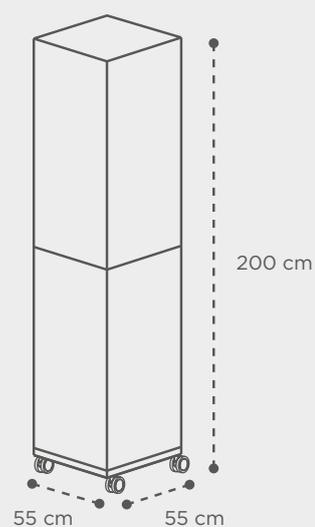

REFERENCIA

6876S4

MEDIDAS PRODUCTO

55 x 200 x 55 cm

EMBALAJE

130 x 120 x 80 cm / 1,248 m³ / 40,00 Kg

Medidas producto: ancho x alto x profundidad.

SKINSUPPORT

SOPORTE MÓVIL PARA PIZARRAS SKINWHITEBOARD





SkinSUPPORT, el soporte móvil de doble cara para la línea de pizarras SKINWHITEBOARD, muy resistente y con un diseño simple.

Sistema de fijación mediante imanes según el sistema patentado Skin. El soporte permite fijar una pizarra a cada lado, dando la posibilidad de conseguir una pizarra de doble cara y pudiendo combinar dos modelos y funcionalidades diferentes. **Pizarras no incluidas.**

Ruedas de diseño para todo tipo de superficies.



COLOR DISPONIBLE



RAL 9003
blanco

! Compatible con los modelos de pizarras SKINWHITEBOARD en formato horizontal de 150 x 100 cm:

- Skin**PRO**
- Skin**COLOUR**
- Skin**MATT**
- Skin**AGILE**
- Skin**MUSIC**
- Skin**MAP**

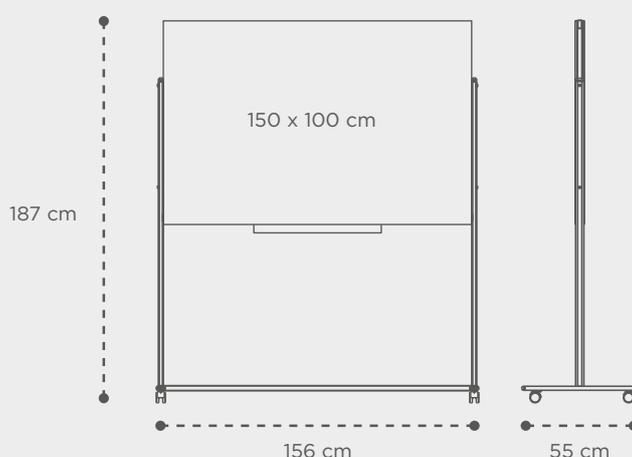

REFERENCIA	MEDIDAS PRODUCTO	EMBALAJE
6875	156 x 187 x 55 cm	159 x 100 x 7 cm / 0,11 m ³ / 17,10 Kg

Medidas producto: ancho x alto x profundidad.

SKINBLOCK

SOPORTE CON BLOCK DE HOJAS DE PAPEL

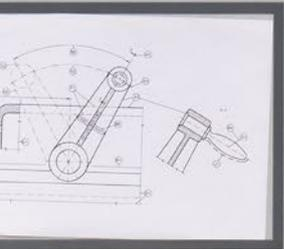

abric
t days

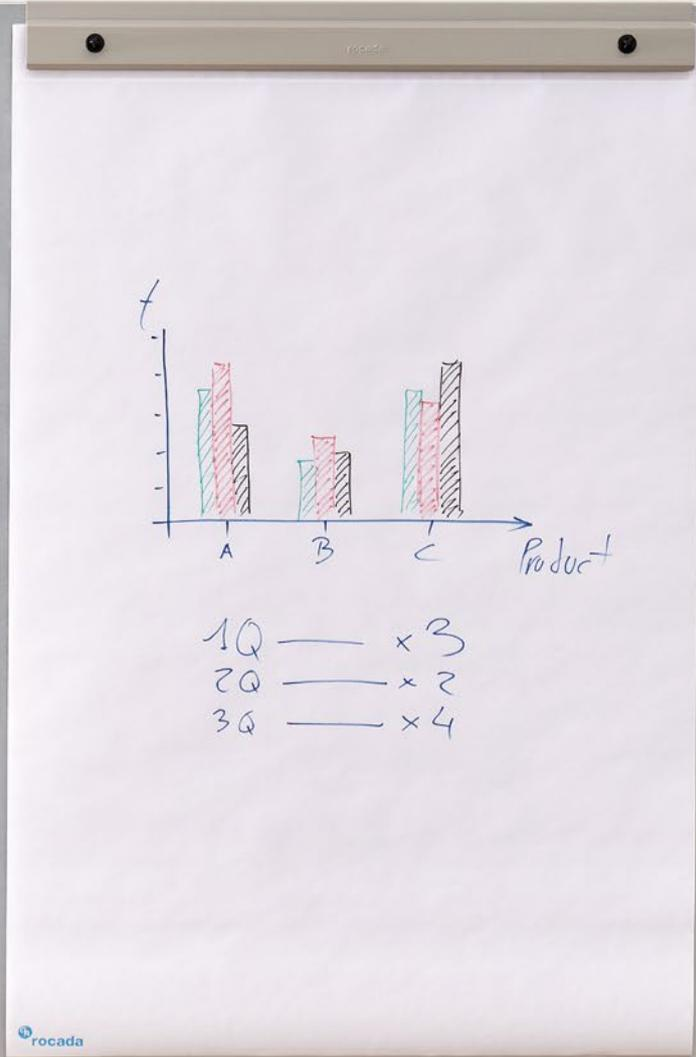



SkinBLOCK es el accesorio perfecto que se adapta a cualquier producto del Skin program. Incluye sistema de fijación y bloque de papel de 20 hojas de 70gr. Su fácil aplicación y fácil recambio agiliza la comunicación en todo momento.



CARACTERÍSTICAS TÉCNICAS

! Bloc de papel de 20 hojas **incluido**.

Compatible con los modelos de pizarras SKINWHITEBOARD:

- Skin**PRO**
- Skin**COLOUR**
- Skin**MATT**
- Skin**AGILE**
- Skin**PLANNER**
- Skin**MUSIC**
- Skin**MAP**

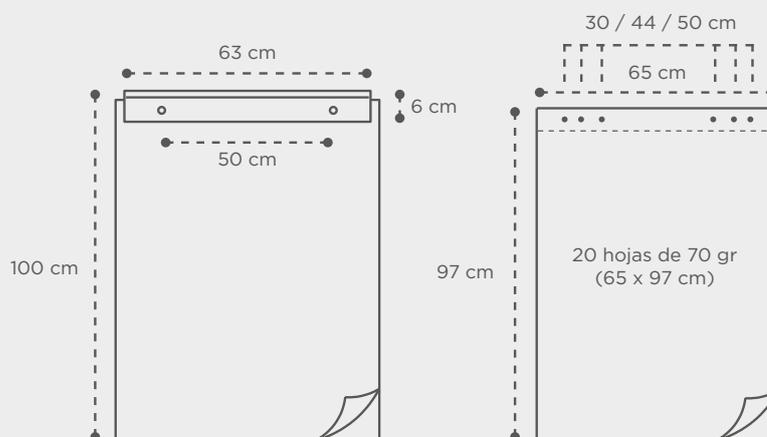

REFERENCIA

MEDIDAS PRODUCTO

EMBALAJE

6430R

100 x 65 x 1 cm

87 x 8 x 8 cm / 0,005 m³ / 1,60 Kg

Medidas producto: ancho x alto x profundidad.

SKINNYNOTES

NOTAS INFORMATIVAS



Remember
the
meeting
at lunch!

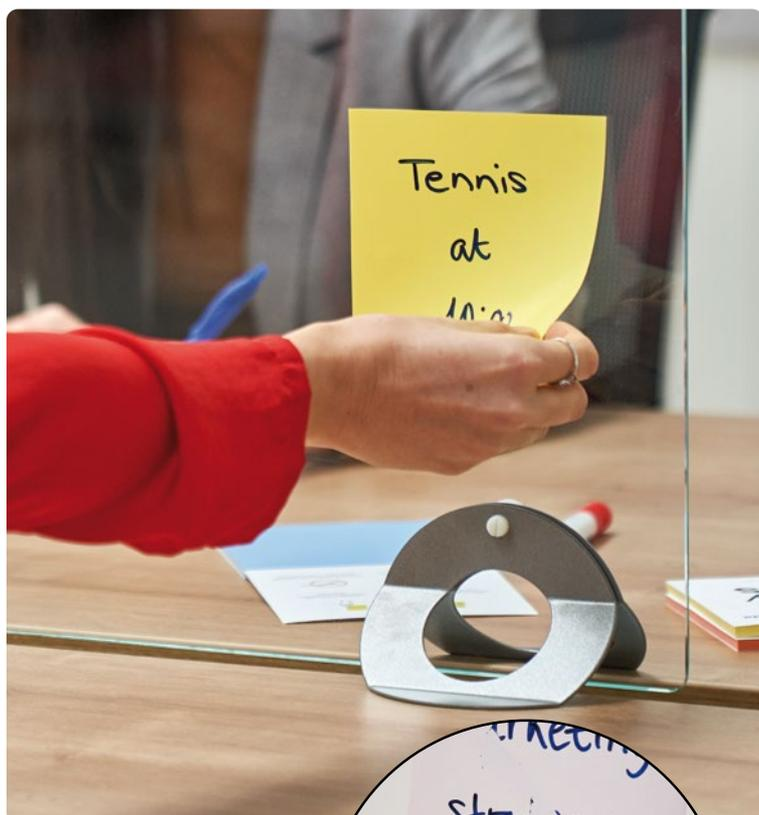

En la parte trasera de la hoja, la escritura se puede borrar.

SkinnyNOTES, notas informativas removibles sin adhesivo que se fijan mediante electricidad electroestática en cualquier tipo de superficie

Permite la escritura en ambas caras con todo tipo de rotuladores. En la parte trasera se puede borrar el texto si se utilizan rotuladores de borrado en seco.

COLORES POR UNIDAD



CARACTERÍSTICAS TÉCNICAS

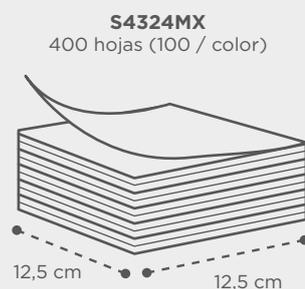
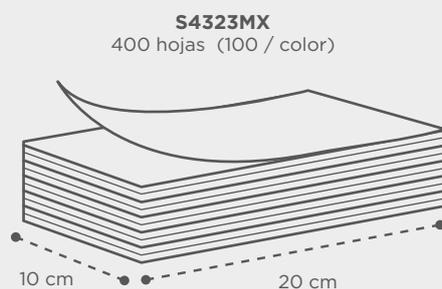

REFERENCIA	HOJAS	Nº HOJAS	EMBALAJE
S4323MX	20 x 10 cm	400 hojas (100 / color)	20 x 10 x 3 cm / 0,001 m ³ / 2,00 Kg
S4324MX	12,5 x 12,5 cm	400 hojas (100 / color)	13 x 13 x 3 cm / 0,001 m ³ / 3,00 Kg

Hojas: ancho x alto.

SKINWHITEBOARD

COMPARATIVA Y TIPOS DE PIZARRAS SKINWHITEBOARD

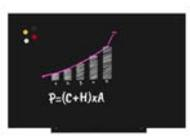
	SkinCERAMIC	SkinPRO	SkinCOLOUR	SkinSHAPE	SkinMATT	SkinLIQUID
						
Años de garantía	25	15	5	5	3	3
Certificación GS	<input type="radio"/>	<input checked="" type="radio"/>	<input checked="" type="radio"/>	<input type="radio"/>	<input type="radio"/>	<input type="radio"/>
Frecuencia de uso	★★★★★★	★★★★★	★★★★★	★★★★★	★★★★★	★★★★★
Magnética	<input checked="" type="radio"/>	<input checked="" type="radio"/>	<input checked="" type="radio"/>	<input checked="" type="radio"/>	<input checked="" type="radio"/>	<input checked="" type="radio"/>
Tipo de superficie	Vitrificada	Lacada con protección adicional (PET)	Lacada	Lacada	Lacada mate	Lacada
Rotuladores	Borrado en seco	Borrado en seco	Borrado en seco	Borrado en seco	Borrado en seco	Tiza líquida
Tipo fijación de bandeja	Atornillada	Sistema "click"	Sistema "click"	Magnética	Sistema "click"	Sistema "click"
Superficie apta para proyecciones	<input type="radio"/>	<input type="radio"/>	<input type="radio"/>	<input type="radio"/>	<input checked="" type="radio"/>	<input type="radio"/>
Resistencia a los arañazos	<input checked="" type="radio"/>	<input type="radio"/>	<input type="radio"/>	<input type="radio"/>	<input type="radio"/>	<input type="radio"/>
Superficie resistente al alcohol	<input checked="" type="radio"/>	<input checked="" type="radio"/>	<input type="radio"/>	<input type="radio"/>	<input type="radio"/>	<input type="radio"/>
Tipo de limpieza	Agua / Alcohol Puntual	Agua / Alcohol Puntual	Agua regularmente	Agua regularmente	Agua regularmente	Agua regularmente
Compatible con SkinSUPPORT	<input type="radio"/>	<input checked="" type="radio"/>	<input checked="" type="radio"/>	<input type="radio"/>	<input checked="" type="radio"/>	<input checked="" type="radio"/>
Compatible con SkinBLOCK	<input type="radio"/>	<input checked="" type="radio"/>	<input checked="" type="radio"/>	<input type="radio"/>	<input checked="" type="radio"/>	<input checked="" type="radio"/>
Compatible con SkinnyNOTES	<input checked="" type="radio"/>	<input checked="" type="radio"/>	<input checked="" type="radio"/>	<input checked="" type="radio"/>	<input checked="" type="radio"/>	<input checked="" type="radio"/>
Unidades por palet	30 unidades aprox.	40 unidades aprox	40 unidades aprox	40 unidades aprox	40 unidades aprox	40 unidades aprox

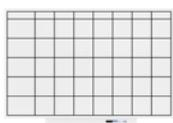
SkinAGILE	SkinPLANNER	SkinMUSIC	SkinCLOCK	SkinMAP	SkinPINBOARD	SkinCUBE
						
3	3	3	3	3	3	3
<input type="radio"/>	<input type="radio"/>	<input type="radio"/>	<input type="radio"/>	<input type="radio"/>	<input type="radio"/>	<input type="radio"/>
<input checked="" type="checkbox"/> <input type="checkbox"/> <input type="checkbox"/> <input type="checkbox"/> <input type="checkbox"/> <input type="checkbox"/>	<input checked="" type="checkbox"/> <input type="checkbox"/> <input type="checkbox"/> <input type="checkbox"/> <input type="checkbox"/> <input type="checkbox"/>	<input checked="" type="checkbox"/> <input checked="" type="checkbox"/> <input checked="" type="checkbox"/> <input type="checkbox"/> <input type="checkbox"/> <input type="checkbox"/>	<input checked="" type="checkbox"/> <input type="checkbox"/> <input type="checkbox"/> <input type="checkbox"/> <input type="checkbox"/> <input type="checkbox"/>	<input checked="" type="checkbox"/> <input type="checkbox"/> <input type="checkbox"/> <input type="checkbox"/> <input type="checkbox"/> <input type="checkbox"/>	<input checked="" type="checkbox"/> <input checked="" type="checkbox"/> <input checked="" type="checkbox"/> <input checked="" type="checkbox"/> <input checked="" type="checkbox"/> <input checked="" type="checkbox"/>	<input checked="" type="checkbox"/> <input checked="" type="checkbox"/> <input checked="" type="checkbox"/> <input type="checkbox"/> <input type="checkbox"/> <input type="checkbox"/>
<input checked="" type="radio"/>	<input checked="" type="radio"/>	<input checked="" type="radio"/>	<input checked="" type="radio"/>	<input checked="" type="radio"/>	<input type="radio"/>	<input checked="" type="radio"/>
Lacada	Lacada	Lacada	Lacada	Vinilada	Tapizada	Lacada
Borrado en seco	Borrado en seco	Borrado en seco	Borrado en seco	Borrado en seco	Chinchetas	Borrado en seco
Sistema "click"	Sistema "click"	Sistema "click"	Sistema "click"	Sistema "click"	-	-
<input type="radio"/>	<input type="radio"/>	<input type="radio"/>	<input type="radio"/>	<input type="radio"/>	<input type="radio"/>	<input type="radio"/>
<input type="radio"/>	<input type="radio"/>	<input type="radio"/>	<input type="radio"/>	<input type="radio"/>	<input checked="" type="radio"/>	<input type="radio"/>
<input type="radio"/>	<input type="radio"/>	<input type="radio"/>	<input type="radio"/>	<input type="radio"/>	<input type="radio"/>	<input type="radio"/>
Agua regularmente	Agua regularmente	Agua regularmente	Agua regularmente	Agua regularmente	-	Agua regularmente
<input checked="" type="radio"/>	<input type="radio"/>	<input checked="" type="radio"/>	<input type="radio"/>	<input checked="" type="radio"/>	<input type="radio"/>	<input type="radio"/>
<input checked="" type="radio"/>	<input checked="" type="radio"/>	<input checked="" type="radio"/>	<input type="radio"/>	<input checked="" type="radio"/>	<input type="radio"/>	<input type="radio"/>
<input checked="" type="radio"/>	<input checked="" type="radio"/>	<input checked="" type="radio"/>	<input checked="" type="radio"/>	<input checked="" type="radio"/>	<input type="radio"/>	<input checked="" type="radio"/>
30 unidades aprox	30 unidades aprox	30 unidades aprox	80 unidades aprox	30 unidades aprox	80 unidades aprox	1 unidad

100% RECICLABLE



La pizarra modular **SKINWHITEBOARD** esta fabricada con materiales de fácil reciclaje y debido a la ausencia de adhesivos la separación de los mismos es directa, sin necesidad de ningún proceso industrial.

1 único palet da la posibilidad de contener diferentes tipos de medidas y acabados.

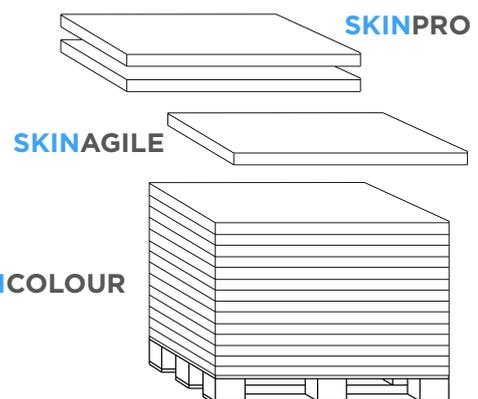



Pizarras con la certificación alemana GS, reconocida a nivel mundial como una de los mejores estándares europeos en seguridad, calidad y continuidad de la fabricación del producto, dando al usuario una máxima seguridad y tranquilidad en su compra.



La calidad y fiabilidad de nuestros procesos de producción están avalados por la certificación ISO 9001:2015



Respetar y proteger el medioambiente es prioritario en nuestros procesos productivos. El uso de productos reciclados y la utilización razonable de los recursos son prioridades inexcusables.



Servicios ambientales con un enfoque integrado para cerrar los bucles de los productos, soluciones de reciclaje y estrategias de prevención de residuos que establecen estándares en toda la industria.

ROCADÁ S.L.
Camí de Can Llebre, 5 · 08552 Taradell BCN (Spain)

SKINWHITEBOARD

SOLUCIONES AVANZADAS PARA IR MÁS LEJOS





rocada

Rocada HQ (Spain)
rocada@rocada.com
www.rocada.com

Rocada Deutschland GmbH
info@rocada.de
www.rocada.de

Rocada Japan LLC
info@rocada.co.jp



Rocada HQ (Spain)
rocada@rocada.com
www.rocada.com

Rocada Deutschland GmbH
info@rocada.de
www.rocada.de

Rocada Japan LLC
info@rocada.co.jp

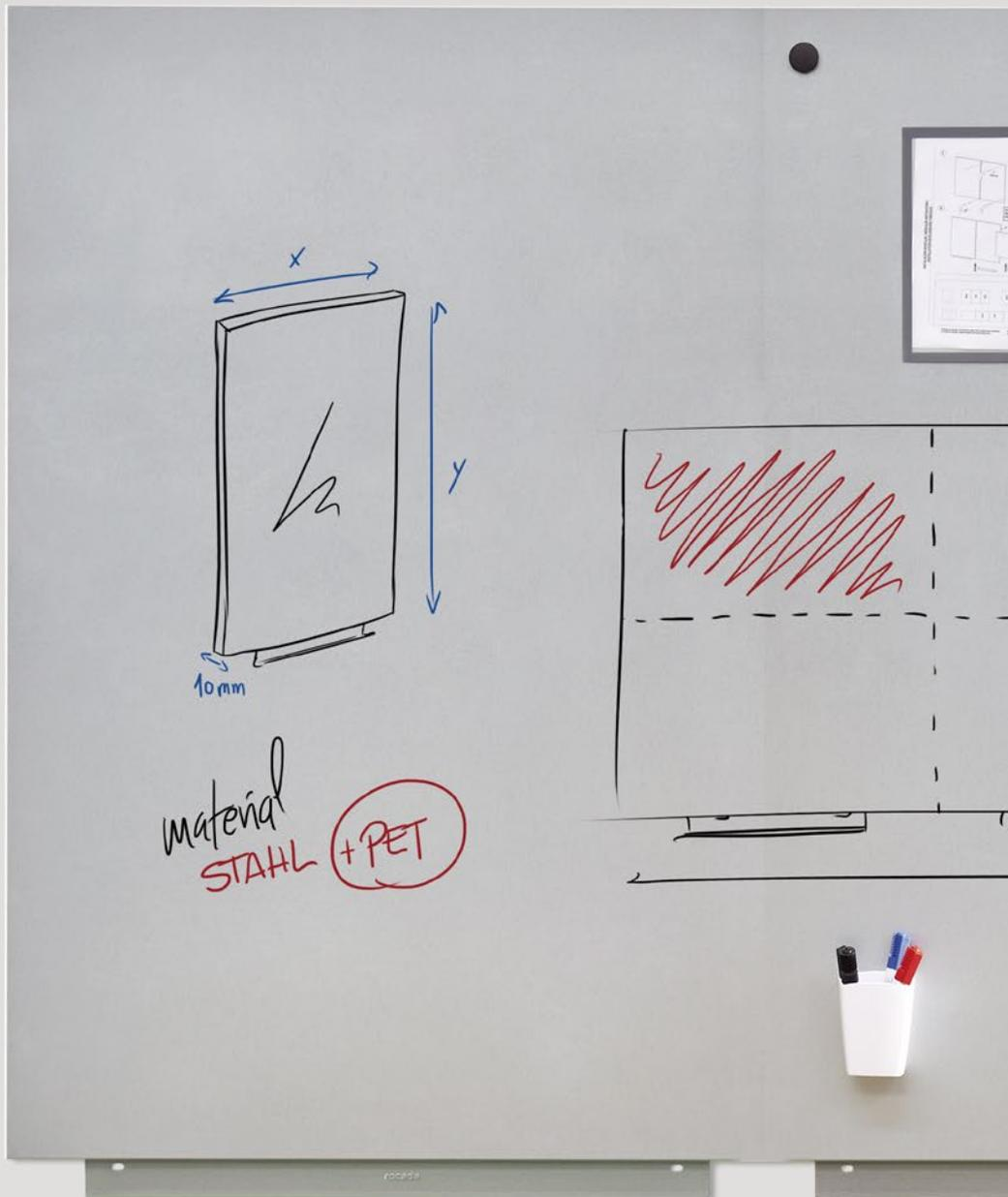



Set
Human working environments

Calidad, confianza, responsabilidad
Quality, trust, responsibility
Qualität, Vertrauen, Verantwortung
Qualité, confiance, responsabilité



Todo el equipo de **Rocada** le da las gracias por su confianza en nuestros productos.
All **Rocada** Team would like to thank you for your confidence in our products.
Das gesamte **Rocada**-Team möchte sich bei Ihnen für Ihr Vertrauen in unsere Produkte bedanken.
Toute l'équipe **Rocada** vous remercie pour votre confiance en ses produits

Marc Roca
CEO

[ESP] Los productos presentados en este catálogo son reproducciones fotográficas impresas, por lo cual pueden ocasionarse leves variaciones de color en el resultado final. Así pues, este catálogo, aún asemejándose mucho a la realidad, sirve sólo a título orientativo.

Rocada se reserva el derecho de modificar sin previo aviso características, medidas y colores de nuestros productos.

[ENG] The products presented in this catalogue are printed photographic reproductions, so there can be colour variations in the end result. Although its contents bear a close resemblance to the actual products, the catalogue is therefore for guidance purposes only.

Rocada reserves the right to change product specifications, sizes or colors without prior notice.

[DE] Bei den in diesem Katalog abgebildeten Produkten handelt es sich um fotografische Wiedergaben, weshalb es hinsichtlich der Farben zu leichten Abweichungen vom Original kommen kann. Trotz weitestgehender Übereinstimmung mit dem Endprodukt ist dieser Katalog also rein informativ zu verstehen.

Rocada behält sich das Recht vor, Merkmale, Abmessungen und Farben der vorgestellten Produkte ohne Vorankündigung zu verändern.

[FR] Les produits présentés dans ce catalogue sont des reproductions photographiques imprimées ; de ce fait, il peut y avoir de légères variations de couleur dans le produit final. Ce catalogue, bien que très proche de la réalité, ne peut donc servir qu'à titre de référence.

Rocada se réserve le droit de modifier sans avis préalable les caractéristiques, les mesures et les couleurs de ses produits.

Stock permanente • Permanent stock Permanente Lagerhaltung • Stock permanent

[ESP] Rapidez • Eficacia • Stock permanente • Entrega inmediata

En un nuevo mundo globalizado, no puedes permitirte el lujo de malgastar espacio y tiempo, Rocada lo sabe. Una estructura de 20.000m² y un almacén de 5.000m² nos permiten disponer de un stock permanente de productos que asegura una entrega inmediata de 7 días.

[ENG] Speed • Efficiency • Permanent stock • Immediate delivery

In a new globalized world, one cannot permit himself the luxury of wasting space and time. Rocada knows this. A structure of 20,000 m² and a warehouse of 5,000 m² allows us to have the product available for immediate 7-day delivery.

[DE] Schnelligkeit • Wirksamkeit • Permanente Lagerung • Sofortige Lieferung

In einer neuen globalisierten Welt kann man sich den Luxus einer Platz- und Zeitverschwendung nicht erlauben. Rocada ist sich dessen bewusst. Ein Betriebsfläche mit 20.000m² und ein Warenlager von 5.000m² erlaubt es uns, über die Produkte zu verfügen und eine sofortige, 7-tägige Lieferung zu garantieren.

[FR] Rapidité • Efficacité • Stock permanent • Livraison immédiate

À l'heure de la mondialisation, vous ne pouvez plus vous permettre le luxe de mal gérer votre espace et votre temps. Rocada en est conscient. Une structure de 20000 m² et un entrepôt de 5000 m² nous permettent de disposer d'un stock permanent de produits afin de garantir une livraison rapide départ usine dans les 7 jours.



Servicio de montaje Montageservice

[ESP] Ofrecemos la posibilidad de montar cualquier material en cualquier punto del territorio español por un módico precio sin pedido mínimo.

[DE] Wir bieten Ihnen die Möglichkeit, unseren Montageservice in jedem Ort in Deutschland zu einem kleinen Aufpreis in Anspruch zu nehmen, unabhängig von der Höhe des Bestellwerts. Bitte erfragen Sie bei uns vorab die Höhe des Aufpreises.

Proyectos a medida Custom projects Benutzerdefinierte Projekte Projets personnalisés

[ESP] Ofrecemos la posibilidad de realizar proyectos a medida con material estándares de nuestro catálogo o con maderas y acabados especiales. Para más información consultar a Rocada.





[ESP] La certificación alemana GS reconocida a nivel mundial como una de las mejores a nivel europeo, garantiza la seguridad, calidad y continuidad de la fabricación del producto, dando al usuario una máxima seguridad y tranquilidad en su compra.

[ENG] GS German certification is world recognised as one of the best in Europe, a guarantee of safety, quality and product production continuity giving the user maximum security and peace of mind when purchasing.

[DE] Die deutsche GS-Zertifizierung ist weltweit als eine der besten europäischen Zertifizierungen anerkannt. Das GS-Zeichen steht für geprüfte Sicherheit, Qualität und Kontinuität der Warenproduktion und signalisiert dem Endverbraucher ein hohes Maß an Sicherheit.

[FR] La certification allemande GS est reconnue au niveau mondial comme une des meilleures en Europe. Elle garantit la sécurité, la qualité et le suivi de production du produit, elle assure au consommateur une sécurité maximale et la tranquillité par rapport à son achat.



ISO 9001:2015

[ESP] La calidad y fiabilidad de nuestros procesos de producción están avalados por la certificación ISO 9001:2015

[ENG] The quality and reliability of our production processes are guaranteed by ISO 9001:2015 certification.

[DE] Die Qualität und Zuverlässigkeit unserer Produktionsprozesse ist durch ISO 9001:2015

[FR] La qualité et la fiabilité de nos processus de production sont garanties par la certification ISO 9001:2015



ISO 14001:2015

[ESP] Respetar y proteger el medioambiente es prioritario en nuestros procesos productivos. El uso de productos reciclados y la utilización razonable de los recursos son prioridades

[ENG] Respect for and protection of the environment are priorities in our production processes. The use of recycled products and the reasonable use of resources are unbending priorities.

[DE] Der Umweltschutz gehört im Rahmen unserer Produktionsprozesse zu den zentralen Anliegen. Der Einsatz von Recyclingmaterialien und die vernünftige Nutzung von natürlichen Ressourcen steht für uns an erster Stelle.

[FR] Respecter et protéger l'environnement est une priorité pour nos processus de production. L'utilisation de matières recyclées et l'utilisation raisonnable des ressources sont des priorités essentielles.



BLANCA

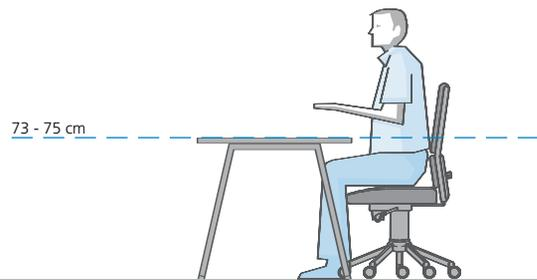

[ESP] SUPERFICIES DE MESA

Cristal templado de 10 mm de grosor. Melamínico sobre aglomerado de 25 mm de grosor con canto de PVC de 2 mm de grosor. Acabados en haya, gris, roble y blanco.

COMPLEMENTOS

Soporte CPU metálico, faldón metálico, separador (melamina, cristal), sistema de electrificación horizontal y vertical.

ESTRUCTURA

Estructura con sistema de regulación independiente (20 mm) fabricada en tubo de acero de 70x30x1,5 mm. Acabado cromado o pintado epoxy según modelo. Travesaños tubulares de acero con nuevas medidas reducidas de 30x30mm para una máxima comodidad. Sistema de fijación del tablero mediante una pieza de polímero técnico.

Para medidas y aplicaciones especiales, consultar a Rocada.

[ENG] TABLE TOPS

10 mm tempered glass. Melamine coated 25 mm particle board with 2 mm thick PVC edges. Beech, grey, oak and white finishes.

ACCESSORIES

Metal CPU support, metal skirting for more privacy, divider (melamine, glass), horizontal and vertical cable management system.

STRUCTURE

Structure with independent height regulation system (20 mm) made out of 70x30x1,5 mm. steel tubing. Chrome or painted epoxy finish depending on model. New reduced size 30 x 30 mm steel tube cross bars for maximum comfort. Board fixing system by a piece of polymer technical.

For special sizes and uses contact Rocada.

[DE] TISCHPLATTEN

Alternativ gehärtete, einseitig Glasplatte (ESG 10mm) oder melaminbeschichtete Spanplatte (25mm) mit 2mm starkem Kunststoff - Umleimer. Dekorauswahl: Buche hell, Lichtgrau, Eiche.

ZUBEHÖR

Metall – Sichtblenden, Trennblenden (melaminbeschichtet oder aus Glas), horizontale und vertikale Kabelführungen. CPU Träger.

GESTELL

Stahlrohrgestell, wahlweise verchromt oder pulverbeschichtet. Tischbeine 70x30x1,5 mm. Traversenstärke 30x30mm. System zur Plattenbefestigung mithilfe eines Teils aus technischem Kunststoff.

Sonderanfertigungen auf Anfrage.

[FR] PLATEAUX DE TABLE

Verre trempé de 10 mm d'épaisseur. Panneau de particules mélaminé de 25 mm d'épaisseur avec chant en PVC de 2 mm d'épaisseur. Finitions hêtre, gris, chêne et blanc.

ACCESSOIRES

Support Unité centrale métallique, voile de fond en métal, séparateur (en mélaminé, verre), système électrique horizontal et vertical.

STRUCTURE

Structure avec système de réglage indépendant (20 mm) en tube d'acier de 70x30x1,5 mm. Finitions chromé ou époxy en fonction du modèle. Barres transversales en tubes d'acier avec de nouvelles dimensions réduites de 30x30 mm pour plus de confort. Système de fixation du tableau moyennant une pièce en polymère technique

Veuillez contacter Rocada pour des dimensions et applications spécifiques.



D	E	F	G
Blue			Red
Green			Blue
Yellow		Red	

Whiteboard area containing:

- A document with text and a small chart.
- A larger line graph showing an upward trend.











For proposals
consider
consequences
Business alternatives
short ideas
analysis
promote your
advantage
Don't pay for proposals
Don't let anyone pay for
Don't let the budget
Don't let someone else



MESA

TABLE • TISCHE • BUREAUX

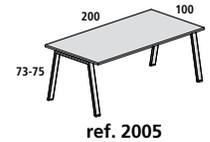

Ref.	cm (producto / product)	kg / m ³ (embalaje / packaging)	N° Packs	Estructura cromada / Chromed structure Verchromtes Gestell / Piétement chromé		Estructura pintada / Painted structure Gestell pulverbeschichtet / Piétement laqué	
				Cristal / Glass	Melamine	Cristal / Glass	Melamine
2000 ⁽²⁾	120x60	35 kg / 0,147 m ³	3	✓	✓	✓	✓
2001	140x80	38 kg / 0,172 m ³	3	✓	✓	✓	✓
2002	160x80	48 kg / 0,182 m ³	3	✓	✓	✓	✓
2003	180x80	52 kg / 0,192 m ³	3	✓	✓	✓	✓
2004	200x80	58 kg / 0,209 m ³	3	✓	✓	✓	✓
2005	200x100	63 kg / 0,222 m ³	3	✓	✓	✓	✓

⁽²⁾ No admite ala auxiliar / Not suitable for wing table.

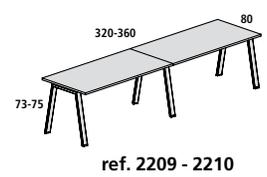
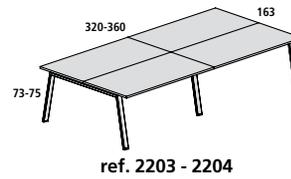
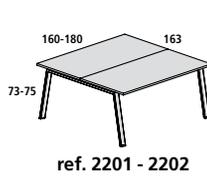

MESA DOBLE

DOUBLE TABLE • MEHRFACHARBEITSTISCHE • DOUBLE TABLES

Ref.	cm (producto / product)	kg / m ³ (embalaje / packaging)	N° Packs	Estructura cromada / Chromed structure Verchromtes Gestell / Piétement chromé		Estructura pintada / Painted structure Gestell pulverbeschichtet / Piétement laqué	
				Cristal / Glass	Melamine	Cristal / Glass	Melamine
2201	160x163	80 kg / 0,257 m ³	4	✓	✓	✓	✓
2202	180x163	87 kg / 0,276 m ³	4	✓	✓	✓	✓
2203	320x163	154 kg / 0,461 m ³	8	✓	✓	✓	✓
2204	360x163	169 kg / 0,496 m ³	8	✓	✓	✓	✓
2209	320x80	88 kg / 0,335 m ³	5	✓	✓	✓	✓
2210	360x80	98 kg / 0,415 m ³	5	✓	✓	✓	✓

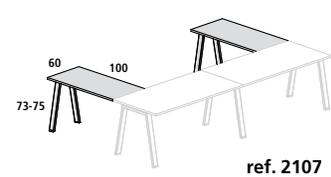
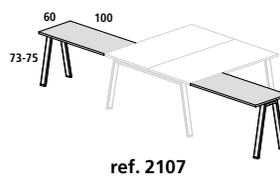
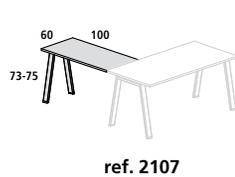

ALA MESA

WING TABLE • ANSTELLTISCH • RETOUR

Ref.	cm (producto / product)	kg / m ³ (embalaje / packaging)	N° Packs	Estructura cromada / Chromed structure Verchromtes Gestell / Piétement chromé		Estructura pintada / Painted structure Gestell pulverbeschichtet / Piétement laqué	
				Cristal / Glass	Melamine	Cristal / Glass	Melamine
2107	100x60	26,5 kg / 0,144 m ³	4	✓	✓	✓	✓

MESAS L

L-TABLES • TISCH IN L-FORM • BUREAU EN L

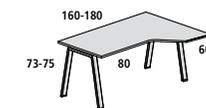

Derecha/ Right / Rechts / Droite

ref. 2051 - 2052

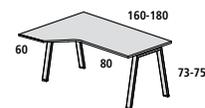

Izquierda / Left / Links / Gauche

ref. 2053 - 2054

Ref.	cm (producto / product)	kg / m ³ (embalaje / packaging)	N° Packs	Estructura cromada / Chromed structure Verchromtes Gestell / Piètement chromé	Estructura pintada / Painted structure Gestell pulverbeschichtet / Piètement laqué
				Melamine	Melamine
2051	160x110x80	52 kg / 0,172 m ³	3	✓	✓
2052	180x110x80	54 kg / 0,184 m ³	3	✓	✓
2053	160x110x80	52 kg / 0,172 m ³	3	✓	✓
2054	180x110x80	54 kg / 0,184 m ³	3	✓	✓

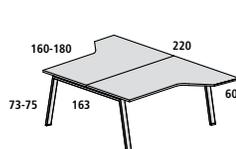

ref. 2205 - 2206

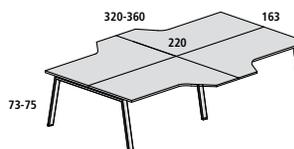

ref. 2207 - 2208

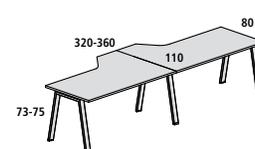

ref. 2211 - 2212

MESAS L DOBLES

DOUBLE L-TABLES • MEHRFACHARBEITSTISCHE IN L-FORM • BUREAU EN L À DOUBLE

Ref.	Cms.	kg / m ³	N° Packs	Estructura cromada / Chromed structure Verchromtes Gestell / Piètement chromé	Estructura pintada / Painted structure Gestell pulverbeschichtet / Piètement laqué
				Melamine	Melamine
2205	160x163x220	88 kg / 0,315 m ³	4	✓	✓
2206	180x163x220	94 kg / 0,346 m ³	4	✓	✓
2207	320x163x220	167 kg / 0,485 m ³	8	✓	✓
2208	360x163x220	182 kg / 0,496 m ³	8	✓	✓
2211	320x110x80	96 kg / 0,403 m ³	6	✓	✓
2212	360x110x80	104 kg / 0,445 m ³	6	✓	✓



Nivelador /Leveler
Nivellierer / Niveleur

Estructura y cableado
Structure and wiring

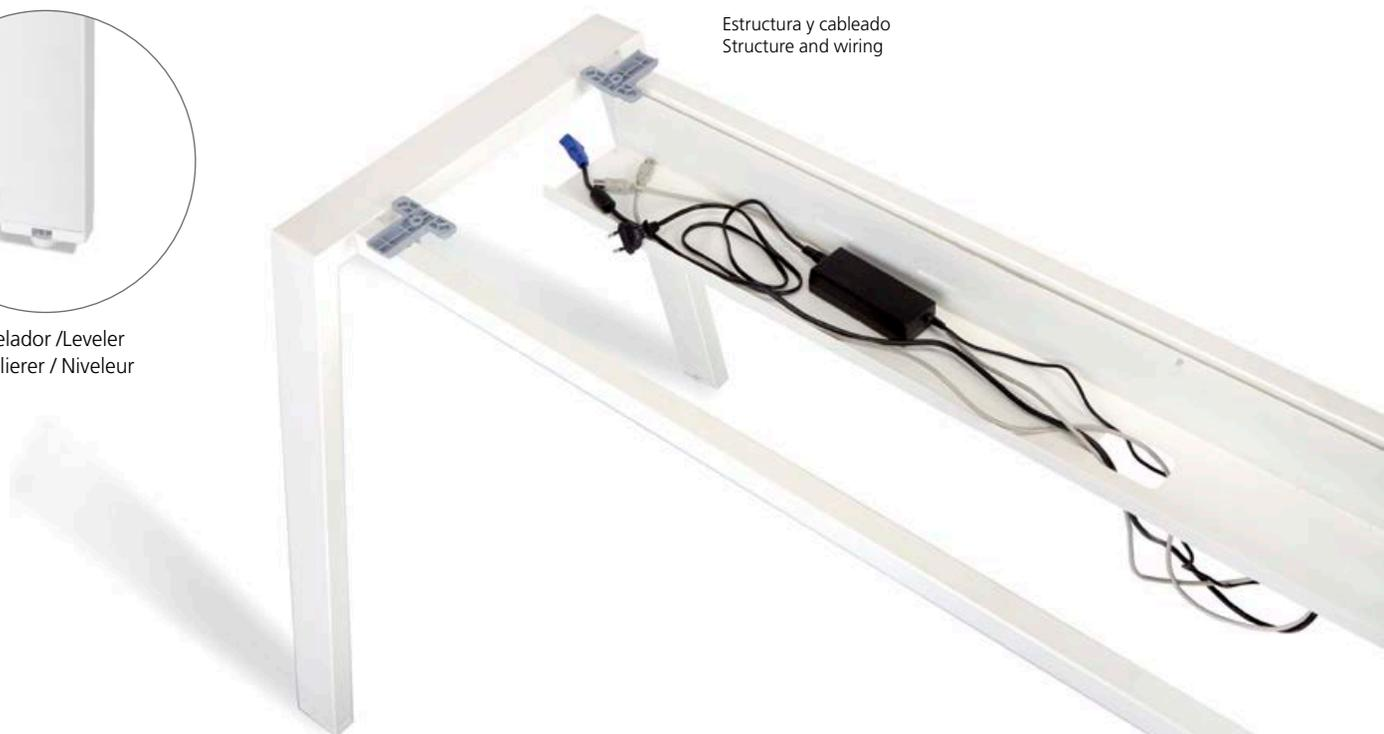

ACABADOS

FINISHES • DEKORE • FINITIONS



MID 01
Alumino / Haya
Aluminium / Beech
Aluminium / Buche
Aluminium / Hêtre



MID 02
Alumino / Gris
Aluminium / Grey
Aluminium / Grau
Aluminium / Gris



MID 04
Alumino / Blanco
Aluminium / White
Aluminium / Weiss
Aluminium / Blanc



MID 05
Alumino / Cristal translúcido
Aluminium / Translucent glass
Aluminium / Satinierte glas
Aluminium / Translucide verre



MID 08
Alumino / Roble
Aluminium / Oak
Aluminium / Eiche
Aluminium / Chêne



MID 15*
Alumino / Cristal pintado negro
Aluminium / Glass painted in black
Aluminium / Schwarz eingefärbtes glas
Aluminium / Verre peint en noir



MID 25*
Alumino / Cristal pintado blanco
Aluminium / Glass painted in white
Aluminium / Weiss eingefärbtes glas
Aluminium / Verre peint en blanc



*Bajo pedido / on request



MIM 01
Blanco / Haya
White / Beech
Weiss / Buche
Blanc / Hêtre



MIM 02
Blanco / Gris
White / Grey
Weiss / Grau
Blanc / Gris



MIM 04
Blanco / Blanco
White / White
Weiss / Weiss
Blanc / Blanc



MIM 05
Blanco / Cristal translúcido
White / Translucent glass
Weiss / Satinierte glas
Blanc / Translucide verre



MIM 08
Blanco / Roble
White / Oak
Weiss / Eiche
Blanc / Chêne



MIM 15*
Blanco / Cristal pintado negro
White / Glass painted in black
Weiss / Schwarz eingefärbtes glas
Blanc / Verre peint en noir

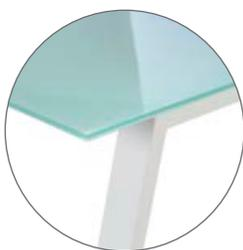

MIM 25*
Blanco / Cristal pintado blanco
White / Glass painted in white
Weiss / Weiss eingefärbtes glas
Blanc / Verre peint en blanc



*Bajo pedido / on request



MIY 01
Antracita / Haya
Anthracite / Beech
Anthrazit / Buche
Anthracite / Hêtre



MIY 02
Antracita / Gris
Anthracite / Grey
Anthrazit / Grau
Anthracite / Gris



MIY 04
Antracita / Blanco
Anthracite / White
Anthrazit / Weiss
Anthracite / Blanc



MIY 05
Antracita / Cristal translúcido
Anthracite / Translucent glass
Anthrazit / Satinierte glas
Anthracite / Translucide verre



MIY 08
Antracita / Roble
Anthracite / Oak
Anthrazit / Eiche
Anthracite / Chêne



MIY 15*
Antracita / Cristal pintado negro
Anthracite / Glass painted in black
Anthrazit / Schwarz eingefärbtes glas
Anthracite / Verre peint en noir

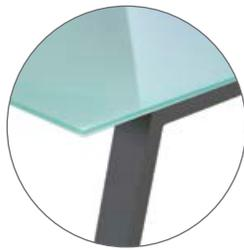

MIY 25*
Antracita / Cristal pintado blanco
Anthracite / Glass painted in white
Anthrazit / Weiss eingefärbtes glas
Anthracite / Verre peint en blanc



*Bajo pedido / on request

CROMADO • CHROMED • VERCHROMT • CHROMÉ



MIE 01
Cromado / Haya
Chrome / Beech
Chrom / Buche
Chrome / Hêtre



MIE 02
Cromado / Gris
Chrome / Grey
Chrom / Grau
Chrome / Gris



MIE 04
Cromado / Blanco
Chrome / White
Chrom / Weiss
Chrome / Blanc



MIE 05
Cromado / Cristal translúcido
Chrome / Translucent glass
Chrom / Satinierte glas
Chrome / Translucide verre



MIE 08
Cromado / Roble
Chrome / Oak
Chrom / Eiche
Chrome / Chêne



MIE 15*
Cromado / Cristal pintado negro
Chrome / Glass painted in black
Chrom / Schwarz eingefärbtes glas
Chrome / Verre peint en noir



MIE 25*
Cromado / Cristal pintado blanco
Chrome / Glass painted in white
Chrom / Weiss eingefärbtes glas
Chrome / Verre peint en blanc

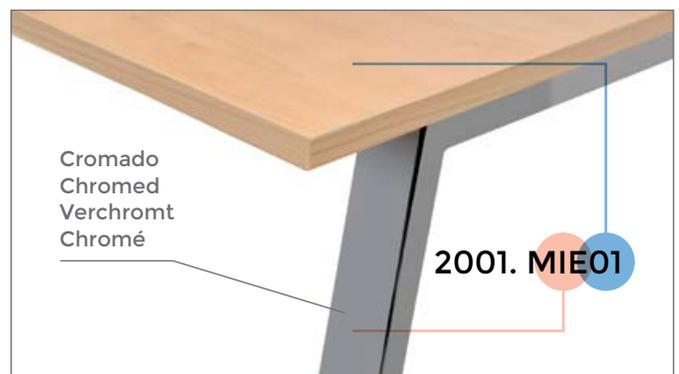

*Bajo pedido / on request

ACCESORIOS

ACCESSORIES • ZUBEHÖR • ACCESSOIRES



Cristal / Glass
Glas / Verre



Melamina / Melamine
Melamin / Mèlamine

1 Faldón metálico
Modesty panel
Metallblende
Voile de fond en métal



2 Electrificación
Wiring
Kabelkette
Système électrique



3 Soporte CPU
CPU support
CPU Träger
Support d'unité centrale



4 Pasacables
Cable duct
Kabelführung
Passe-câbles



5 Separador
Divider
Trennblenden
Séparateur

6 Caja conexión
Cable management box
Mehrfachsteckdose
Boîtier de branchements



117-137-157-177

ref. 3939/W/S/Y - 3940/W/S/Y
3941/W/S/Y - 3942/W/S/Y

1 FALDÓN METÁLICO MESA / MODESTY PANEL / METALLBLENDE / VOILE DE FOND EN MÉTAL

Ref. aluminio / aluminium	Ref. blanco / white weiss / blanc	Ref. plata / silver silber / argent	Ref. antracita / anthracite anthrazit / anthracite	cm (producto / product)	Medidas mesa / Table size	kg / m ³ (embalaje / pack)	Nº bultos / packs
3939	3939W	3939S	3939Y	117x30	140	5 kg / 0,015 m ³	1
3940	3940W	3940S	3940Y	137x30	160	5,5 kg / 0,018 m ³	1
3941	3941W	3941S	3941Y	157x30	180	6 kg / 0,020 m ³	1
3942	3942W	3942S	3942Y	177x30	200	6,5 kg / 0,023 m ³	1



ref. 2901⁽¹⁾

2 ELECTRIFICACIÓN / WIRING / KABELKETTE / SYSTÈME ÉLECTRIQUE

Ref.	cm (producto / product)	kg / m ³ (embalaje / pack)	Nº bultos / packs	Acabados / Finishes Dekore / Finitons
2901 ⁽¹⁾	46x46x7	2 kg / 0,014 m ³	1	gris / grey / grau / gris

⁽¹⁾ sólo tableros melamina / only melamine boards



ref. 2943/W/Y/S⁽¹⁾

3 SOPORTE CPU / CPU SUPPORT / CPU TRÄGER / SUPPORT D'UNITÉ CENTRALE

Ref.	cm (producto / product)	kg / m ³ (embalaje / pack)	Nº bultos / packs	Acabados / Finishes Dekore / Finitons
2943 ⁽¹⁾	25x45x55	9 kg / 0,011 m ³	1	aluminio / aluminium
2943W ⁽¹⁾	25x45x55	9 kg / 0,011 m ³	1	blanco / white / weiss / blanc
2943Y ⁽¹⁾	25x45x55	9 kg / 0,011 m ³	1	antracita / anthracite / anthrazit / anthracite
2943S ⁽¹⁾	25x45x55	9 kg / 0,011 m ³	1	plata / silver / asilber / argent

⁽¹⁾ sólo tableros melamina / only melamine boards

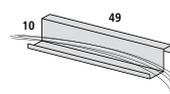

ref. 2921/W/Y/S⁽¹⁾

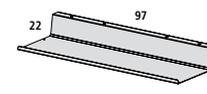

ref. 2922/W/Y/S⁽¹⁾⁽²⁾

Accesorio no disponible para mesas de 120 x 60 cm

4 PASACABLES / CABLE DUCT / KABELFÜHRUNG/ PASSE-CÂBLES

Ref.	cm (producto / product)	kg / m ³ (embalaje / pack)	Nº bultos / packs	Acabados / Finishes Dekore / Finitons
2921 ⁽¹⁾	49x10x6	1 kg / 0,002 m ³	1	aluminio / aluminium
2921W ⁽¹⁾	49x10x6	1 kg / 0,002 m ³	1	blanco / white / weiss / blanc
2921Y ⁽¹⁾	49x10x6	1 kg / 0,002 m ³	1	antracita / anthracite / anthrazit / anthracite
2921S ⁽¹⁾	49x10x6	1 kg / 0,002 m ³	1	plata / silver / silber / argent
2922 ⁽¹⁾⁽²⁾	97x22x6	3,5 kg / 0,015 m ³	1	aluminio / grau / gris
2922W ⁽¹⁾⁽²⁾	97x22x6	3,5 kg / 0,015 m ³	1	blanco / white / weiss / blanc
2922Y ⁽¹⁾⁽²⁾	97x22x6	3,5 kg / 0,015 m ³	1	antracita / anthracite / anthrazit / anthracite
2922S ⁽¹⁾⁽²⁾	97x22x6	3,5 kg / 0,015 m ³	1	plata / silver / silber / argent

⁽¹⁾ sólo tableros melamina / only melamine boards

⁽²⁾ accesorio para mesas a partir de 140cm / Accessory to be used from 140cm tables

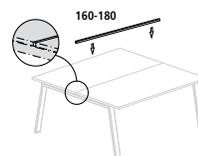

ref. 2960* - 2961* - 2960V* - 2961V*

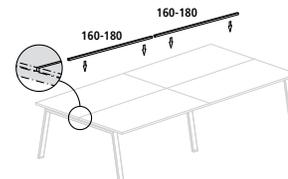

ref. 2962* - 2963* - 2962V* - 2963V*

EMBELLECEDOR MESA / TABLE COVER
ABDECKLEISTE / EMBELLISSEUR DE TABLE

Ref. mesas melamina / melamine tables	Ref. mesas cristal / glass tables	Cms.	kg / m ³	Nº bultos / packs	Acabados / Finishes / Dekore / Finitons			
					AE Cromado Chromed	AD Aluminio Aluminium	AM Blanco White	AY Antracita Anthracite
2960* (1u)	2960V* (1u)	160	2 kg / 0,005 m ³	1	✓	✓	✓	✓
2961* (1u)	2961V* (1u)	180	2 kg / 0,005 m ³	1	✓	✓	✓	✓
2962* (2u)	2962V* (2u)	160	4 kg / 0,005 m ³	1	✓	✓	✓	✓
2963* (2u)	2963V* (2u)	180	4 kg / 0,005 m ³	1	✓	✓	✓	✓

* Bajo pedido / On request / Auf Anforderung / Sur demande.

5 SEPARADOR / DIVIDER / TRENNBLENDEN / SÉPARATEUR

* Bajo pedido / On request / Auf Anforderung / Sur demande.

MELAMINA / MELAMINE / MELAMIN / MÉLAMINE

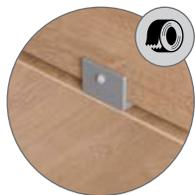
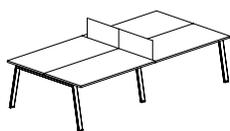

ref. 2905AE*



ref. 2905IE*



ref. 2905IV*

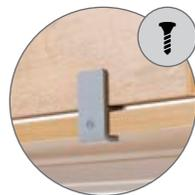
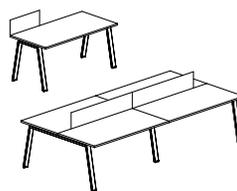

ref. 2903IE*

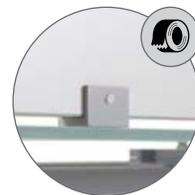

ref. 2903IV*

CRISTAL / GLASS / GLAS / VERRE

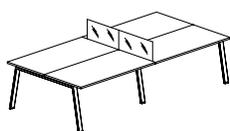

ref. 2916*



ref. 2916IE*

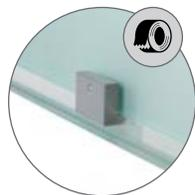
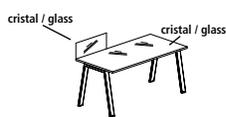

ref. 2916IV*

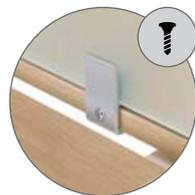
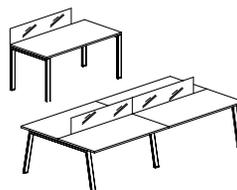

ref. 2917IE*

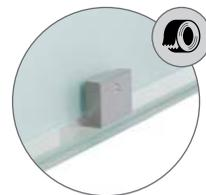

ref. 2917IV*

Ref.	cm (producto / product)	kg / m ³	Nº Packs	Acabados / Finishes / Dekore / Finitons
2916* (1u)	70x40	7 kg / 0,020 m ³	1	Cristal translúcido / Translucent glass Satinierter glas / Translucide verre
2916IE* (1u)				
2916IV* (1u)				
2917IE* (1u)	136x40	14 kg / 0,053 m ³	1	
2917IV* (1u)				
2905AE* (1u)	70x40	7 kg / 0,020 m ³	1	01* Haya Beech 02* Gris Grey 04* Blanco White 08* Roble Oak
2905IE* (1u)				
2905IV* (1u)				
2903IE* (1u)	136x40	10 kg / 0,032 m ³	1	
2903IV* (1u)				

6 CAJA CONEXIÓN / CABLE MANAGEMENT BOX / MEHRFACHSTECKDOSE / BOÎTIER DE BRANCHEMENTS

No incluye mecanizado / Fixing not included / Montageservice auf Anfrage / Usinage et adaptation non compris



ref. 2964

2 shucko + 1 2RJ45 + 2m wiring/kabel

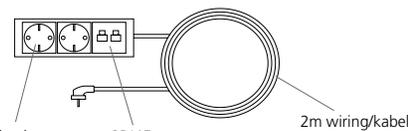

ref. 2965

vacío / empty / leere / vides

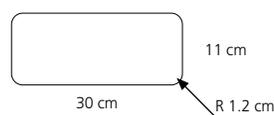

Dimensiones agujero / Hole sizes

Ref.	cm (producto / product)	kg / m ³ (embalaje / pack)	Nº bultos / packs	Acabados / Finishes / Dekore / Finitons
2964	32x13x10	1,2 kg / 0,060 m ³	1	gris / grey / grau / gris
2965	32x13x10	0,5 kg / 0,060 m ³	1	gris / grey / grau / gris

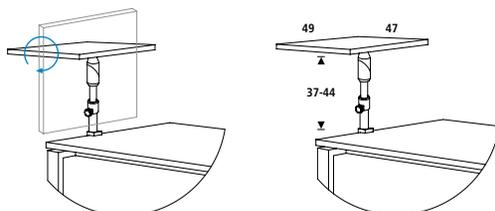

7 SEGUNDO NIVEL ABATIBLE / FOLDABLE SECOND LEVEL / ZWEITE EBENE ABKLAPPBAR / DEUXIÈME NIVEAU ARTICULÉ

Ref.	cm (producto / product)	kg / m ³ (embalaje / pack)	Nº bultos / packs
2906V19	50x50x11	4 kg / 0,021 m ³	1



ACABADOS / FINISHES
DEKORE / FINITIONS



01
Haya · Beech
Buche · Hêtre



02
Gris · Grey
Grau · Gris

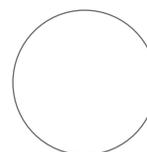

04
Blanco · White
Weiss · Blanc



08
Roble · Oak
Eiche · Chêne

8 PIZARRA LACADA MAGNÉTICA PARA PANEL DIVISOR / MAGNETIC LACQUERED WHITEBOARD PANEL DIVIDER
LACKIERTE MAGNETTAFEL ALS TRENNPLATTE / TABLEAU LAQUÉ MAGNÉTIQUE POUR PANNEAU DIVISEUR

Ref.	cm (producto / product)	kg / m ³ (embalaje / pack)	Nº bultos / packs	Acabados / Finishes / Dekore / Finitions
1900W	50x40x4	2 kg / 0,008 m ³	1	blanco / white / weiss / blanc

8

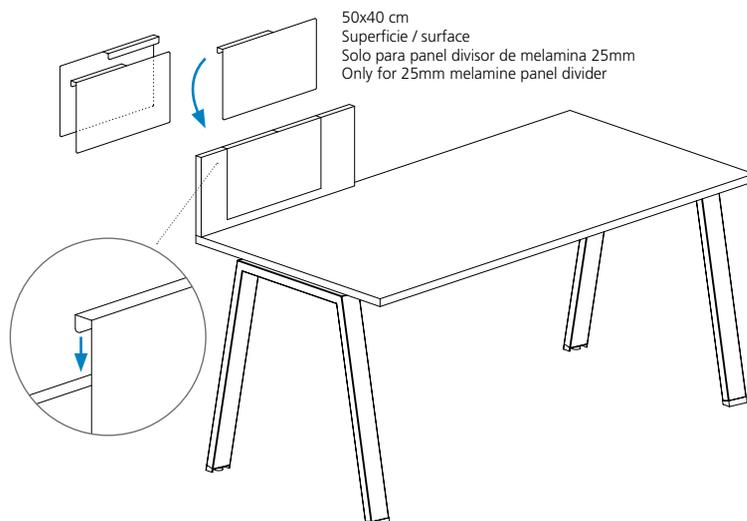

TOTAL

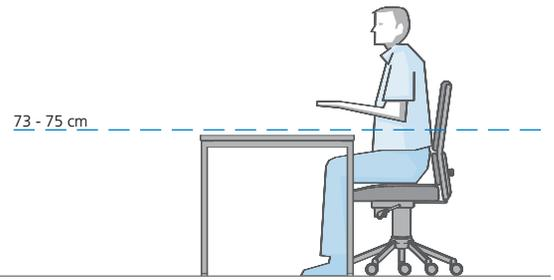

[ESP] SUPERFICIES DE MESA

Cristal templado de 10 mm de grosor. Melamínico sobre aglomerado de 25 mm de grosor con canto de PVC de 2 mm de grosor. Acabados en haya, gris, roble y blanco.

COMPLEMENTOS

Soporte CPU metálico, faldón metálico, separador (melamina, cristal), sistema de electrificación horizontal y vertical.

ESTRUCTURA

Estructura con sistema de regulación independiente (50 mm) fabricada en tubo de acero de 70x30x1,5 mm. Acabado cromado o pintado epoxy según modelo. Travesaños tubulares de acero con nuevas medidas reducidas de 30x30mm para una máxima comodidad. Sistema de fijación del tablero mediante una pieza de polímero técnico.

Para medidas y aplicaciones especiales, consultar a Rocada.

[ENG] TABLE TOPS

10 mm tempered glass. Melamine coated 25 mm particle board with 2 mm thick PVC edges. Beech, grey, oak and white finishes.

ACCESSORIES

Metal CPU support, metal skirting for more privacy, divider (melamine, glass), horizontal and vertical cable management system.

STRUCTURE

Structure with independent height regulation system (50 mm) made out of 70x30x1,5 mm. steel tubing. Chrome or painted epoxy finish depending on model. New reduced size 30 x 30 mm steel tube cross bars for maximum comfort. Board fixing system by a piece of polymer technical.

For special sizes and uses contact Rocada.

[DE] TISCHPLATTEN

Alternativ gehärtete, einseitig Glasplatte (ESG 10mm) oder melaminbeschichtete Spanplatte (25mm) mit 2mm starkem Kunststoff - Umleimer. Dekorauswahl: Buche hell, Lichtgrau, Eiche.

ZUBEHÖR

Metall – Sichtblenden, Trennblenden (melaminbeschichtet oder aus Glas), horizontale und vertikale Kabelführungen. CPU Träger.

GESTELL

Stahlrohrgestell, wahlweise verchromt oder pulverbeschichtet. Tischbeine 70x30x1,5 mm. Traversenstärke 30x30mm. System zur Plattenbefestigung mithilfe eines Teils aus technischem Kunststoff.

Sonderanfertigungen auf Anfrage.

[FR] PLATEAUX DE TABLE

Verre trempé de 10 mm d'épaisseur. Panneau de particules mélaminé de 25 mm d'épaisseur avec chant en PVC de 2 mm d'épaisseur. Finitions hêtre, gris, chêne et blanc.

ACCESSOIRES

Support Unité centrale métallique, voile de fond en métal, séparateur (en mélaminé, verre), système électrique horizontal et vertical.

STRUCTURE

Structure avec système de réglage indépendant (50 mm) en tube d'acier de 70x30x1,5 mm. Finitions chromé ou époxy en fonction du modèle. Barres transversales en tubes d'acier avec de nouvelles dimensions réduites de 30x30 mm pour plus de confort. Système de fixation du tableau moyennant une pièce en polymère technique

Veillez contacter Rocada pour des dimensions et applications spécifiques.











Break
10:00 h





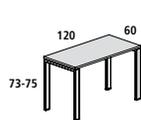

ref. 2000 ⁽²⁾

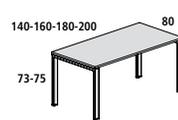

ref. 2001 - 2002 - 2003 - 2004

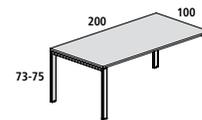

ref. 2005

MESA

TABLE • TISCHE • BUREAUX

Ref.	cm (producto / product)	kg / m ³ (embalaje / packaging)	N° Packs	Estructura cromada / Chromed structure Verchromtes Gestell / Piétement chromé		Estructura pintada / Painted structure Gestell pulverbeschichtet / Piétement laqué	
				Cristal / Glass	Melamine	Cristal / Glass	Melamine
2000 ⁽²⁾	120x60	37 kg / 0,147 m ³	3	✓	✓	✓	✓
2001	140x80	40 kg / 0,172 m ³	3	✓	✓	✓	✓
2002	160x80	50 kg / 0,182 m ³	3	✓	✓	✓	✓
2003	180x80	54 kg / 0,192 m ³	3	✓	✓	✓	✓
2004	200x80	60 kg / 0,209 m ³	3	✓	✓	✓	✓
2005	200x100	65 kg / 0,222 m ³	3	✓	✓	✓	✓

⁽²⁾ No admite ala auxiliar / Not suitable for wing table.

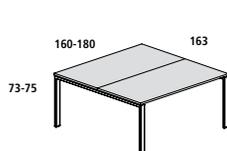

ref. 2201 - 2202

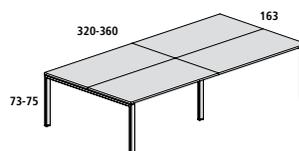

ref. 2203 - 2204

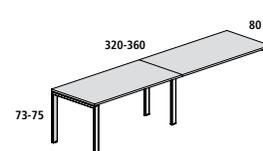

ref. 2209 - 2210

MESA DOBLE

DOUBLE TABLE • MEHRFACHARBEITSTISCHE • DOUBLE TABLES

Ref.	cm (producto / product)	kg / m ³ (embalaje / packaging)	N° Packs	Estructura cromada / Chromed structure Verchromtes Gestell / Piétement chromé		Estructura pintada / Painted structure Gestell pulverbeschichtet / Piétement laqué	
				Cristal / Glass	Melamine	Cristal / Glass	Melamine
2201	160x163	84 kg / 0,257 m ³	4	✓	✓	✓	✓
2202	180x163	91 kg / 0,276 m ³	4	✓	✓	✓	✓
2203	320x163	162 kg / 0,461 m ³	8	✓	✓	✓	✓
2204	360x163	177 kg / 0,496 m ³	8	✓	✓	✓	✓
2209	320x80	92 kg / 0,336 m ³	5	✓	✓	✓	✓
2210	360x80	102 kg / 0,416 m ³	5	✓	✓	✓	✓

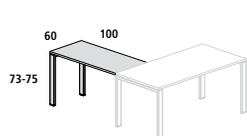

ref. 2107

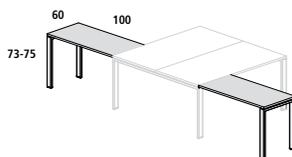

ref. 2107

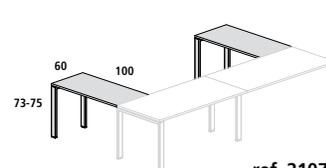

ref. 2107

ALA MESA

WING TABLE • ANSTELLTISCH • RETOUR

Ref.	cm (producto / product)	kg / m ³ (embalaje / packaging)	N° Packs	Estructura cromada / Chromed structure Verchromtes Gestell / Piétement chromé		Estructura pintada / Painted structure Gestell pulverbeschichtet / Piétement laqué	
				Cristal / Glass	Melamine	Cristal / Glass	Melamine
2107	100x60	27,5 kg / 0,144 m ³	4	✓	✓	✓	✓

MESAS L

L-TABLES • TISCH IN L-FORM • BUREAU EN L

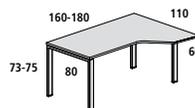

Derecha/ Right / Rechts / Droite

ref. 2051 - 2052

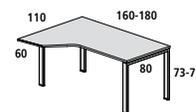

Izquierda / Left / Links / Gauche

ref. 2053 - 2054

Ref.	cm (producto / product)	kg / m ³ (embalaje / packaging)	N° Packs	Estructura cromada / Chromed structure Verchromtes Gestell / Piétement chromé	Estructura pintada / Painted structure Gestell pulverbeschichtet / Piétement laqué
				Melamine	Melamine
2051	160x110x80	54 kg / 0,172 m ³	3	✓	✓
2052	180x110x80	56 kg / 0,184 m ³	3	✓	✓
2053	160x110x80	54 kg / 0,172 m ³	3	✓	✓
2054	180x110x80	56 kg / 0,184 m ³	3	✓	✓

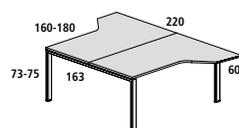

ref. 2205 - 2206

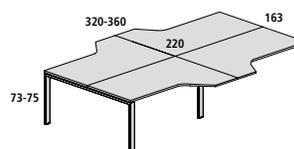

ref. 2207 - 2208

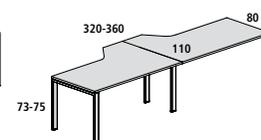

ref. 2211 - 2212

MESAS L DOBLES

DOUBLE L-TABLES • MEHRFACHARBEITSTISCHE IN L-FORM • BUREAU EN L À DOUBLE

Ref.	Cms.	kg / m ³	N° Packs	Estructura cromada / Chromed structure Verchromtes Gestell / Piétement chromé	Estructura pintada / Painted structure Gestell pulverbeschichtet / Piétement laqué
				Melamine	Melamine
2205	160x163x220	92 kg / 0,315 m ³	4	✓	✓
2206	180x163x220	98 kg / 0,346 m ³	4	✓	✓
2207	320x163x220	175 kg / 0,485 m ³	8	✓	✓
2208	360x163x220	190 kg / 0,496 m ³	8	✓	✓
2211	320x110x80	100 kg / 0,403 m ³	6	✓	✓
2212	360x110x80	108 kg / 0,445 m ³	6	✓	✓

Estructura y cableado
Structure and wiring

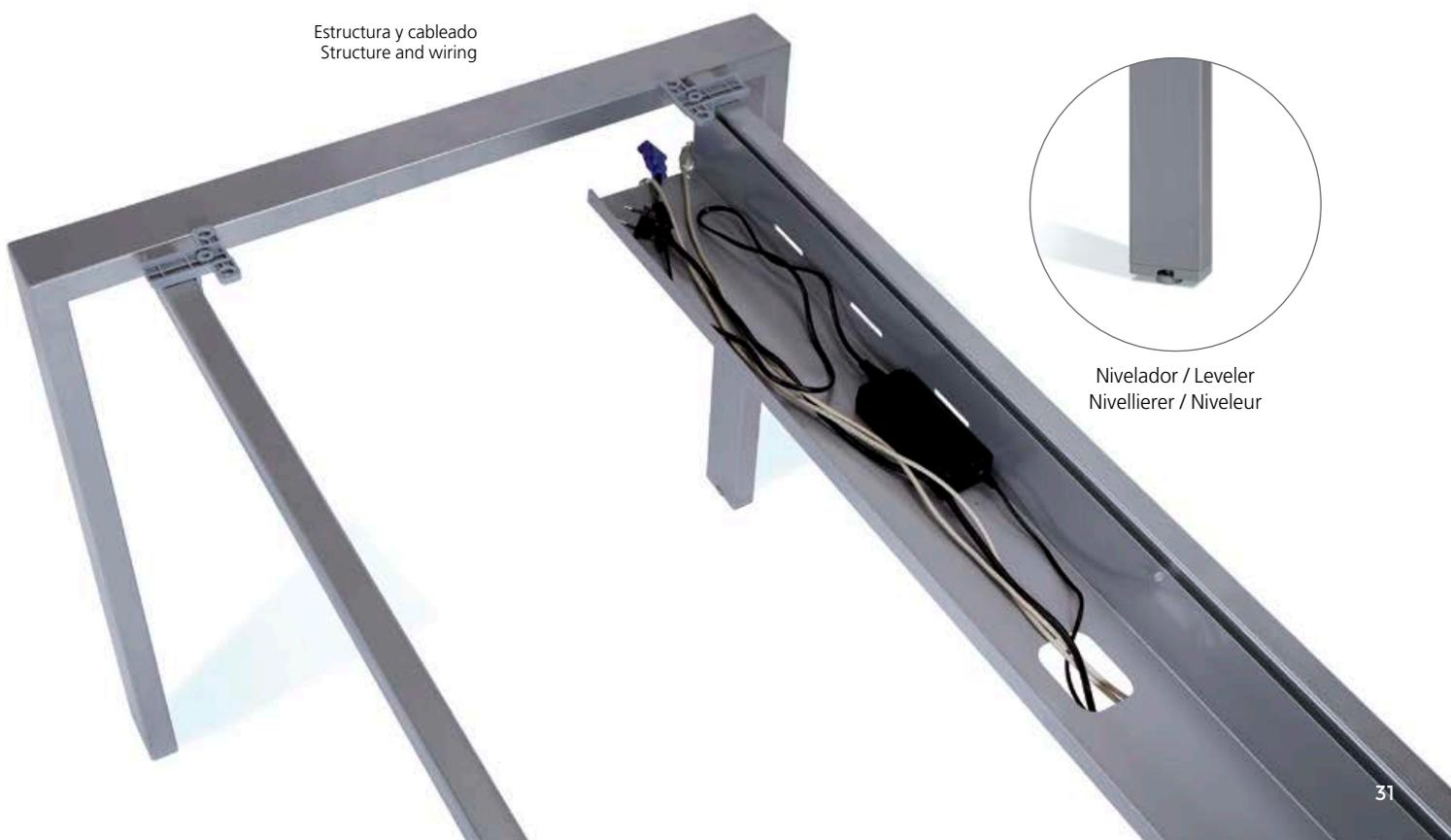

Nivelador / Leveler
Nivellier / Niveleur

ACABADOS

FINISHES • DEKORE • FINITIONS



MD 01
Alumino / Haya
Aluminium / Beech
Aluminium / Buche
Aluminium / Hêtre



MD 02
Alumino / Gris
Aluminium / Grey
Aluminium / Grau
Aluminium / Gris



MD 04
Alumino / Blanco
Aluminium / White
Aluminium / Weiss
Aluminium / Blanc

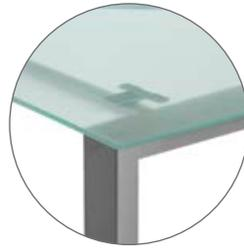

MD 05
Alumino / Cristal translúcido
Aluminium / Translucent glass
Aluminium / Satinierte glas
Aluminium / Translucide verre



MD 08
Alumino / Roble
Aluminium / Oak
Aluminium / Eiche
Aluminium / Chêne



MD 15*
Alumino / Cristal pintado negro
Aluminium / Glass painted in black
Aluminium / Schwarz eingefärbtes glas
Aluminium / Verre peint en noir

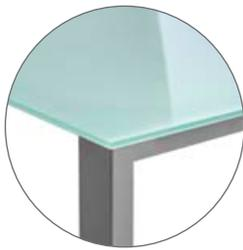

MD 25*
Alumino / Cristal pintado blanco
Aluminium / Glass painted in white
Aluminium / Weiss eingefärbtes glas
Aluminium / Verre peint en blanc



*Bajo pedido / on request



MM 01
Blanco / Haya
White / Beech
Weiss / Buche
Blanc / Hêtre



MM 02
Blanco / Gris
White / Grey
Weiss / Grau
Blanc / Gris



MM 04
Blanco / Blanco
White / White
Weiss / Weiss
Blanc / Blanc



MM 05
Blanco / Cristal translúcido
White / Translucent glass
Weiss / Satinierte glas
Blanc / Translucide verre



MM 08
Blanco / Roble
White / Oak
Weiss / Eiche
Blanc / Chêne



MM 15*
Blanco / Cristal pintado negro
White / Glass painted in black
Weiss / Schwarz eingefärbtes glas
Blanc / Verre peint en noir



MM 25*
Blanco / Cristal pintado blanco
White / Glass painted in white
Weiss / Weiss eingefärbtes glas
Blanc / Verre peint en blanc



*Bajo pedido / on request



MY 01
Antracita / Haya
Anthracite / Beech
Anthrazit / Buche
Anthracite / Hêtre



MY 02
Antracita / Gris
Anthracite / Grey
Anthrazit / Grau
Anthracite / Gris



MY 04
Antracita / Blanco
Anthracite / White
Anthrazit / Weiss
Anthracite / Blanc

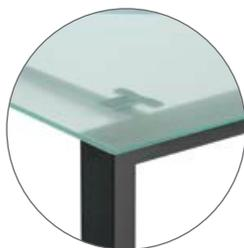

MY 05
Antracita / Cristal translúcido
Anthracite / Translucent glass
Anthrazit / Satinierte glas
Anthracite / Translucide verre



MY 08
Antracita / Roble
Anthracite / Oak
Anthrazit / Eiche
Anthracite / Chêne



MY 15*
Antracita / Cristal pintado negro
Anthracite / Glass painted in black
Anthrazit / Schwarz eingefärbtes glas
Anthracite / Verre peint en noir



MY 25*
Antracita / Cristal pintado blanco
Anthracite / Glass painted in white
Anthrazit / Weiss eingefärbtes glas
Anthracite / Verre peint en blanc



*Bajo pedido / on request

CROMADO • CHROMED • VERCHROMT • CHROMÉ



ME 01
Cromado / Haya
Chrome / Beech
Chrom / Buche
Chrome / Hêtre



ME 02
Cromado / Gris
Chrome / Grey
Chrom / Grau
Chrome / Gris



ME 04
Cromado / Blanco
Chrome / White
Chrom / Weiss
Chrome / Blanc



ME 05
Cromado / Cristal translúcido
Chrome / Translucent glass
Chrom / Satinierte glas
Chrome / Translucide verre



ME 08
Cromado / Roble
Chrome / Oak
Chrom / Eiche
Chrome / Chêne



ME 15*
Cromado / Cristal pintado negro
Chrome / Glass painted in black
Chrom / Schwarz eingefärbtes glas
Chrome / Verre peint en noir



ME 25*
Cromado / Cristal pintado blanco
Chrome / Glass painted in white
Chrom / Weiss eingefärbtes glas
Chrome / Verre peint en blanc



*Bajo pedido / on request

ACCESORIOS

ACCESSORIES • ZUBEHÖR • ACCESSOIRES



Cristal / Glass
Glas / Verre



Melamina / Melamine
Melamin / Mèlamine



- 1 Faldón metálico
Modesty panel
Metallblende
Voile de fond en métal



- 2 Electrificación
Wiring
Kabelkette
Système électrique



- 3 Soporte CPU
CPU support
CPU Träger
Support d'unité centrale



- 4 Pasacables
Cable duct
Kabelführung
Passe-câbles



- 5 Separador
Divider
Trennblenden
Séparateur

- 6 Caja conexión
Cable management box
Mehrfachsteckdose
Boîtier de branchements



117-137-157-177

ref. 3939/W/S/Y - 3940/W/S/Y
3941/W/S/Y - 3942/W/S/Y

1 FALDÓN METÁLICO MESA / MODESTY PANEL / METALLBLENDE / VOILE DE FOND EN MÉTAL

Ref. aluminio / aluminium	Ref. blanco / white weiss / blanc	Ref. plata / silver silber / argent	Ref. antracita / anthracite anthrazit / anthracite	cm (producto / product)	Medidas mesa / Table size	kg / m ³ (embalaje / pack)	Nº bultos / packs
3939	3939W	3939S	3939Y	117x30	140	5 kg / 0,015 m ³	1
3940	3940W	3940S	3940Y	137x30	160	5,5 kg / 0,018 m ³	1
3941	3941W	3941S	3941Y	157x30	180	6 kg / 0,020 m ³	1
3942	3942W	3942S	3942Y	177x30	200	6,5 kg / 0,023 m ³	1

ref. 2901⁽¹⁾

2 ELECTRIFICACIÓN / WIRING / KABELKETTE / SYSTÈME ÉLECTRIQUE

Ref.	cm (producto / product)	kg / m ³ (embalaje / pack)	Nº bultos / packs	Acabados / Finishes Dekore / Finitons
2901 ⁽¹⁾	46x46x7	2 kg / 0,014 m ³	1	gris / grey / grau / gris

⁽¹⁾ sólo tableros melamina / only melamine boards



3 SOPORTE CPU / CPU SUPPORT / CPU TRÄGER / SUPPORT D'UNITÉ CENTRALE

ref. 2943/W/Y/S⁽¹⁾

Ref.	cm (producto / product)	kg / m ³ (embalaje / pack)	Nº bultos / packs	Acabados / Finishes Dekore / Finitons
2943 ⁽¹⁾	25x45x55	9 kg / 0,011 m ³	1	aluminio / aluminium
2943W ⁽¹⁾	25x45x55	9 kg / 0,011 m ³	1	blanco / white / weiss / blanc
2943Y ⁽¹⁾	25x45x55	9 kg / 0,011 m ³	1	antracita / anthracite / anthrazit / anthracite
2943S ⁽¹⁾	25x45x55	9 kg / 0,011 m ³	1	plata / silver / asilber / argent

⁽¹⁾ sólo tableros melamina / only melamine boards

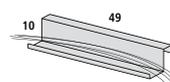
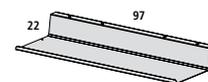
ref. 2921/W/Y/S⁽¹⁾ref. 2922/W/Y/S⁽¹⁾⁽²⁾

Accesorio no disponible para mesas de 120 x 60 cm

4 PASACABLES / CABLE DUCT / KABELFÜHRUNG/ PASSE-CÂBLES

Ref.	cm (producto / product)	kg / m ³ (embalaje / pack)	Nº bultos / packs	Acabados / Finishes Dekore / Finitons
2921 ⁽¹⁾	49x10x6	1 kg / 0,002 m ³	1	aluminio / aluminium
2921W ⁽¹⁾	49x10x6	1 kg / 0,002 m ³	1	blanco / white / weiss / blanc
2921Y ⁽¹⁾	49x10x6	1 kg / 0,002 m ³	1	antracita / anthracite / anthrazit / anthracite
2921S ⁽¹⁾	49x10x6	1 kg / 0,002 m ³	1	plata / silver / silber / argent
2922 ⁽¹⁾⁽²⁾	97x22x6	3,5 kg / 0,015 m ³	1	aluminio / grau / gris
2922W ⁽¹⁾⁽²⁾	97x22x6	3,5 kg / 0,015 m ³	1	blanco / white / weiss / blanc
2922Y ⁽¹⁾⁽²⁾	97x22x6	3,5 kg / 0,015 m ³	1	antracita / anthracite / anthrazit / anthracite
2922S ⁽¹⁾⁽²⁾	97x22x6	3,5 kg / 0,015 m ³	1	plata / silver / silber / argent

⁽¹⁾ sólo tableros melamina / only melamine boards

⁽²⁾ accesorio para mesas a partir de 140cm / Accessory to be used from 140cm tables

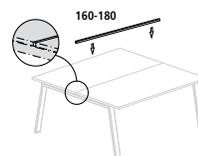

ref. 2960* - 2961* - 2960V* - 2961V*

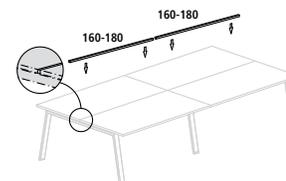

ref. 2962* - 2963* - 2962V* - 2963V*

EMBELLECEDOR MESA / TABLE COVER ABDECKLEISTE / EMBELLISSEUR DE TABLE

Ref. mesas melamina / melamine tables	Ref. mesas cristal / glass tables	Cms.	kg / m ³	Nº bultos / packs	Acabados / Finishes / Dekore / Finitons			
					AE Cromado Chromed	AD Aluminio Aluminium	AM Blanco White	AY Antracita Anthracite
2960* (1u)	2960V* (1u)	160	2 kg / 0,005 m ³	1	✓	✓	✓	✓
2961* (1u)	2961V* (1u)	180	2 kg / 0,005 m ³	1	✓	✓	✓	✓
2962* (2u)	2962V* (2u)	160	4 kg / 0,005 m ³	1	✓	✓	✓	✓
2963* (2u)	2963V* (2u)	180	4 kg / 0,005 m ³	1	✓	✓	✓	✓

* Bajo pedido / On request / Auf Anforderung / Sur demande.

5 SEPARADOR / DIVIDER / TRENNBLENDEN / SÉPARATEUR

* Bajo pedido / On request / Auf Anforderung / Sur demande.

MELAMINA / MELAMINE / MELAMIN / MÉLAMINE

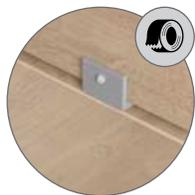
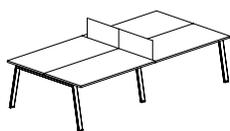

ref. 2905AE*



ref. 2905IE*

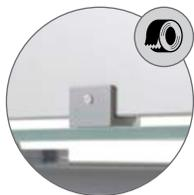

ref. 2905IV*

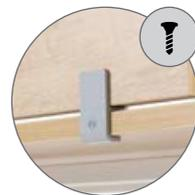
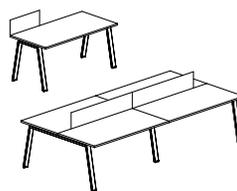

ref. 2903IE*

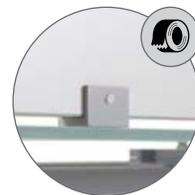

ref. 2903IV*

CRISTAL / GLASS / GLAS / VERRE

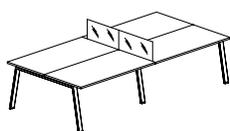

ref. 2916*



ref. 2916IE*

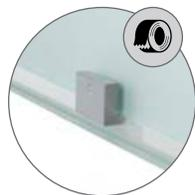
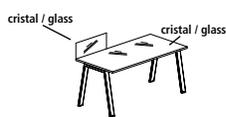

ref. 2916IV*

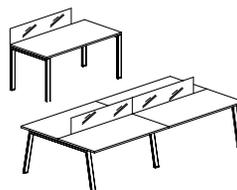

ref. 2917IE*

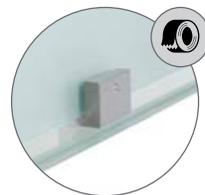

ref. 2917IV*

Ref.	cm (producto / product)	kg / m ³	Nº Packs	Acabados / Finishes / Dekore / Finitons
2916* (1u)	70x40	7 kg / 0,020 m ³	1	Cristal translúcido / Translucent glass Satinierter glas / Translucide verre
2916IE* (1u)				
2916IV* (1u)				
2917IE* (1u)	136x40	14 kg / 0,053 m ³	1	
2917IV* (1u)				
2905AE* (1u)	70x40	7 kg / 0,020 m ³	1	01* Haya Beech 02* Gris Grey 04* Blanco White 08* Roble Oak
2905IE* (1u)				
2905IV* (1u)				
2903IE* (1u)				
2903IV* (1u)	136x40	10 kg / 0,032 m ³	1	

6 CAJA CONEXIÓN / CABLE MANAGEMENT BOX / MEHRFACHSTECKDOSE / BOÎTIER DE BRANCHEMENTS

No incluye mecanizado / Fixing not included / Montageservice auf Anfrage / Usinage et adaptation non compris



ref. 2964
2 shucko + 1 2RJ45 + 2m wiring/kabel

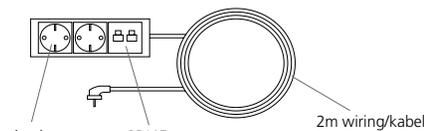

ref. 2965
vacío / empty / leere / vides

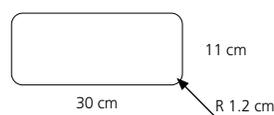

Dimensiones agujero / Hole sizes

Ref.	cm (producto / product)	kg / m ³ (embalaje / pack)	Nº bultos / packs	Acabados / Finishes / Dekore / Finitons
2964	32x13x10	1,2 kg / 0,060 m ³	1	gris / grey / grau / gris
2965	32x13x10	0,5 kg / 0,060 m ³	1	gris / grey / grau / gris

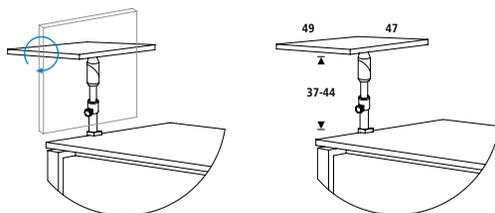

7 SEGUNDO NIVEL ABATIBLE / FOLDABLE SECOND LEVEL / ZWEITE EBENE ABKLAPPBAR / DEUXIÈME NIVEAU ARTICULÉ

Ref.	cm (producto / product)	kg / m ³ (embalaje / pack)	Nº bultos / packs
2906V19	50x50x11	4 kg / 0,021 m ³	1



ACABADOS / FINISHES
DEKORE / FINITIONS



01
Haya · Beech
Buche · Hêtre



02
Gris · Grey
Grau · Gris

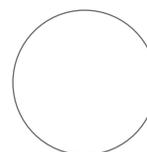

04
Blanco · White
Weiss · Blanc



08
Roble · Oak
Eiche · Chêne

8 PIZARRA LACADA MAGNÉTICA PARA PANEL DIVISOR / MAGNETIC LACQUERED WHITEBOARD PANEL DIVIDER
LACKIERTE MAGNETTAFEL ALS TRENNPLATTE / TABLEAU LAQUÉ MAGNÉTIQUE POUR PANNEAU DIVISEUR

Ref.	cm (producto / product)	kg / m ³ (embalaje / pack)	Nº bultos / packs	Acabados / Finishes / Dekore / Finitions
1900W	50x40x4	2 kg / 0,008 m ³	1	blanco / white / weiss / blanc

8

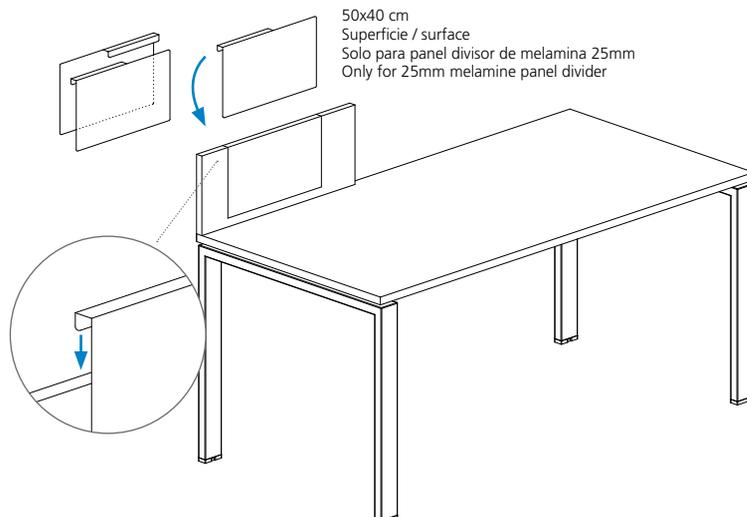

EXECUTIVE

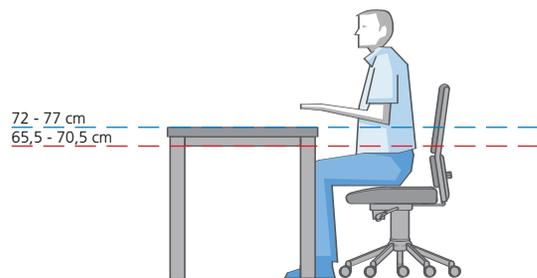

[ESP] SUPERFICIES DE MESA

Cristal templado de 10 mm de grosor. Melamínico sobre aglomerado de 25 mm de grosor con canto de PVC de 2 mm de grosor. Acabados en haya, gris, roble y blanco.

COMPLEMENTOS

Soporte CPU metálico, faldón metálico, separador (melamina, cristal), sistema de electrificación horizontal y vertical.

ESTRUCTURA

Estructura con sistema de regulación independiente (50 mm) fabricada en tubo de acero de 60x60x1,5 mm. Acabado cromado o pintado epoxy según modelo. Sistema de anclaje en fundición de aluminio. Travesaños tubulares de acero con nuevas medidas reducidas de 40x30mm para una máxima comodidad.

Para medidas y aplicaciones especiales, consultar a Rocada.

[ENG] TABLE TOPS

10 mm tempered glass. Melamine coated 25 mm particle board with 2 mm thick PVC edges. Beech, grey, oak and white finishes.

ACCESSORIES

Metal CPU support, metal skirting for more privacy, divider (melamine, glass), horizontal and vertical cable management system.

STRUCTURE

Structure with independent height regulation system (50 mm) made out of 60 x 60 x 1,5 mm steel tubing. Chrome or painted epoxy finish depending on model. Die cast aluminium anchoring system. New reduced size 40 x 30 mm steel tube cross bars for maximum comfort.

For special sizes and uses contact Rocada.

[DE] TISCHPLATTEN

Alternativ gehärtete, einseitig Glasplatte (ESG 10mm) oder melaminbeschichtete Spanplatte (25mm) mit 2mm starkem Kunststoff - Umleimer. Dekorauswahl: Buche hell, Lichtgrau, Eiche.

ZUBEHÖR

Metall – Sichtblenden, Trennblenden (melaminbeschichtet oder aus Glas), horizontale und vertikale Kabelführungen. CPU Träger.

GESTELL

Stahlrohrgestell, wahlweise verchromt oder pulverbeschichtet. Tischbeine 60x60x1,5 mm. Traversenstärke 40x30mm. Tischhöhe von 720 – 770mm individuell einstellbar.

Sonderanfertigungen auf Anfrage.

[FR] PLATEAUX DE TABLE

Verre trempé de 10 mm d'épaisseur. Panneau de particules mélaminé de 25 mm d'épaisseur avec chant en PVC de 2 mm d'épaisseur. Finitions hêtre, gris, chêne et blanc.

ACCESSOIRES

Support Unité centrale métallique, voile de fond en métal, séparateur (en mélaminé, verre), système électrique horizontal et vertical.

STRUCTURE

Structure avec système de réglage indépendant (50 mm) en tube d'acier de 60x60x1,5 mm. Finitions chromé ou époxy en fonction du modèle. Système de fixation en aluminium fondu. Barres transversales en tubes d'acier avec de nouvelles dimensions réduites de 40x30 mm pour plus de confort.

Veillez contacter Rocada pour des dimensions et applications spécifiques.













	A	B	C	D	E	F	G
1				??			Pa's Carving
2			for Paol				
3					High + 100		
4	Box 100			Lunch 2.0		Long 7	
5							



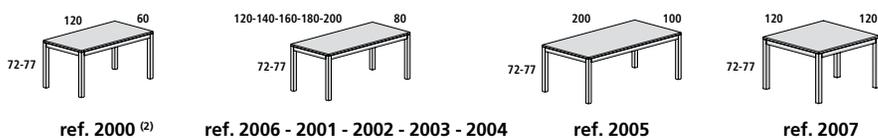

MESA

TABLE • TISCHE • BUREAUX

Ref.	cm (producto / product)	kg / m ³ (embalaje / packaging)	Nº bultos / packs	Estructura cromada / Chromed structure Verchromtes Gestell / Piétement chromé		Estructura pintada / Painted structure Gestell pulverbeschichtet / Piétement laqué	
				Cristal / Glass	Melamine	Cristal / Glass	Melamine
2000 ⁽²⁾	120x60	32 kg / 0,077 m ³	3	✓	✓	✓	✓
2006	120x80	34 kg / 0,095 m ³	3	✓	✓	✓	✓
2001	140x80	36 kg / 0,102 m ³	3	✓	✓	✓	✓
2002	160x80	45 kg / 0,112 m ³	3	✓	✓	✓	✓
2003	180x80	49 kg / 0,122 m ³	3	✓	✓	✓	✓
2004	200x80	55 kg / 0,139 m ³	3	✓	✓	✓	✓
2005	200x100	60 kg / 0,152 m ³	3	✓	✓	✓	✓
2007	120x120	49 kg / 0,122 m ³	3	✓	✓	✓	✓

⁽²⁾ No admite ala auxiliar / Not suitable for wing table.

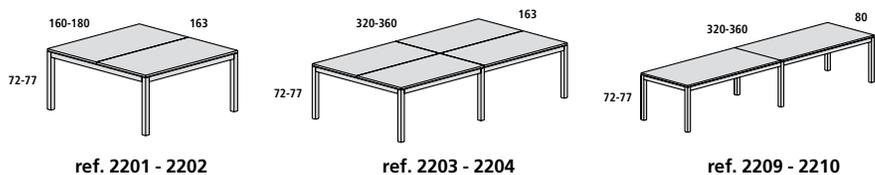

MESA DOBLE

DOUBLE TABLE • MEHRFACHARBEITSTISCHE • DOUBLE TABLES

Ref.	cm (producto / product)	kg / m ³ (embalaje / packaging)	Nº bultos / packs	Estructura cromada / Chromed structure Verchromtes Gestell / Piétement chromé		Estructura pintada / Painted structure Gestell pulverbeschichtet / Piétement laqué	
				Cristal / Glass	Melamine	Cristal / Glass	Melamine
2201	160x163	74,5 kg / 0,187 m ³	4	✓	✓	✓	✓
2202	180x163	81 kg / 0,206 m ³	4	✓	✓	✓	✓
2203	320x163	142 kg / 0,356 m ³	8	✓	✓	✓	✓
2204	360x163	157 kg / 0,391 m ³	8	✓	✓	✓	✓
2209	320x80	82 kg / 0,230 m ³	5	✓	✓	✓	✓
2210	360x80	92 kg / 0,310 m ³	5	✓	✓	✓	✓

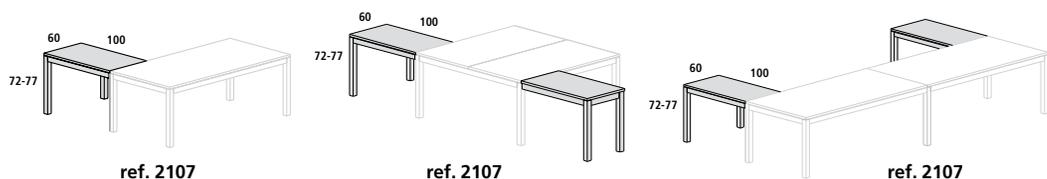

ALA MESA

WING TABLE • ANSTELLTISCH • RETOUR

Ref.	cm (producto / product)	kg / m ³ (embalaje / packaging)	Nº bultos / packs	Estructura cromada / Chromed structure Verchromtes Gestell / Piétement chromé		Estructura pintada / Painted structure Gestell pulverbeschichtet / Piétement laqué	
				Cristal / Glass	Melamine	Cristal / Glass	Melamine
2107	100x60	25 kg / 0,074 m ³	4	✓	✓	✓	✓

MESAS L

L-TABLES • TISCH IN L-FORM • BUREAU EN L

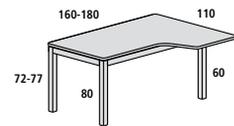

Derecha/ Right / Rechts / Droite

ref. 2051 - 2052

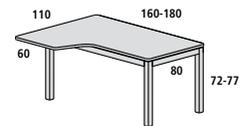

Izquierda / Left / Links / Gauche

ref. 2053 - 2054

Ref.	cm (producto / product)	kg / m ³ (embalaje / packaging)	Nº bultos / packs	Estructura cromada / Chromed structure Verchromtes Gestell / Piétement chromé	Estructura pintada / Painted structure Gestell pulverbeschichtet / Piétement laqué
				Melamine	Melamine
2051	160x110x80	49 kg / 0,102 m ³	3	✓	✓
2052	180x110x80	51 kg / 0,114 m ³	3	✓	✓
2053	160x110x80	49 kg / 0,102 m ³	3	✓	✓
2054	180x110x80	51 kg / 0,114 m ³	3	✓	✓

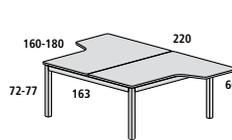

ref. 2205 - 2206

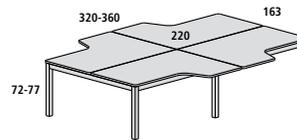

ref. 2207 - 2208

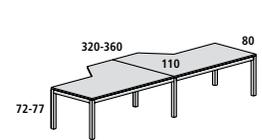

ref. 2211 - 2212

MESAS L DOBLES

DOUBLE L-TABLES • MEHRFACHARBEITSTISCHE IN L-FORM • BUREAU EN L À DOUBLE

Ref.	Cms.	kg / m ³	Nº bultos / packs	Estructura cromada / Chromed structure Verchromtes Gestell / Piétement chromé	Estructura pintada / Painted structure Gestell pulverbeschichtet / Piétement laqué
				Melamine	Melamine
2205	160x163x220	82 kg / 0,245 m ³	4	✓	✓
2206	180x163x220	88 kg / 0,276 m ³	4	✓	✓
2207	320x163x220	155 kg / 0,380 m ³	8	✓	✓
2208	360x163x220	170 kg / 0,391 m ³	8	✓	✓
2211	320x110x80	90 kg / 0,298 m ³	6	✓	✓
2212	360x110x80	98 kg / 0,340 m ³	6	✓	✓

Estructura y cableado
Structure and wiring

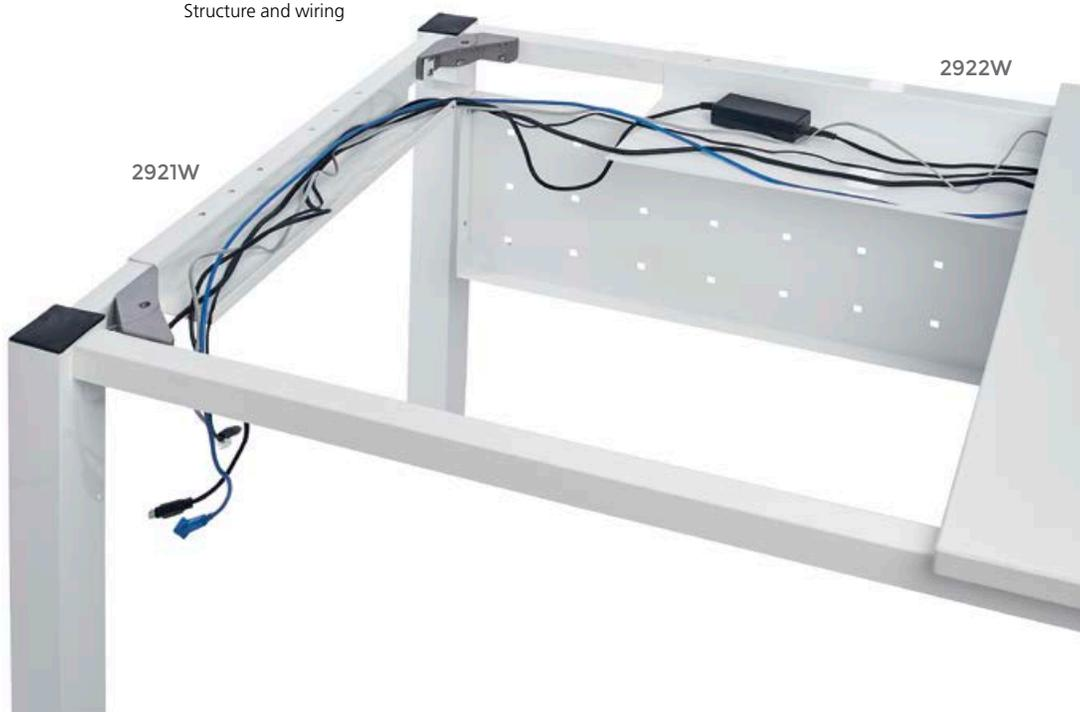

ACABADOS

FINISHES • DEKORE • FINITIONS



AD 01
 Aluminio / Haya
 Aluminium / Beech
 Aluminium / Buche
 Aluminium / Hêtre



AD 02
 Aluminio / Gris
 Aluminium / Grey
 Aluminium / Grau
 Aluminium / Gris



AD 04
 Aluminio / Blanco
 Aluminium / White
 Aluminium / Weiss
 Aluminium / Blanc

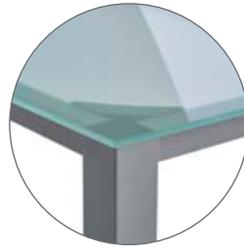

AD 05
 Aluminio / Cristal translúcido
 Aluminium / Translucent glass
 Aluminium / Satinierte glas
 Aluminium / Translucide verre



AD 08
 Aluminio / Roble
 Aluminium / Oak
 Aluminium / Eiche
 Aluminium / Chêne



AD 15*
 Aluminio / Cristal pintado negro
 Aluminium / Glass painted in black
 Aluminium / Schwarz eingefärbtes glas
 Aluminium / Verre peint en noir

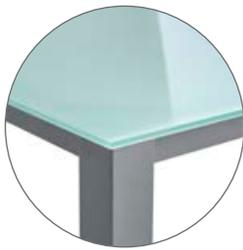

AD 25*
 Aluminio / Cristal pintado blanco
 Aluminium / Glass painted in white
 Aluminium / Weiss eingefärbtes glas
 Aluminium / Verre peint en blanc



*Bajo pedido / on request



AM 01
 Blanco / Haya
 White / Beech
 Weiss / Buche
 Blanc / Hêtre



AM 02
 Blanco / Gris
 White / Grey
 Weiss / Grau
 Blanc / Gris



AM 04
 Blanco / Blanco
 White / White
 Weiss / Weiss
 Blanc / Blanc

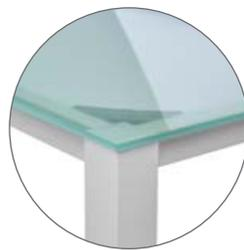

AM 05
 Blanco / Cristal translúcido
 White / Translucent glass
 Weiss / Satinierte glas
 Blanc / Translucide verre



AM 08
 Blanco / Roble
 White / Oak
 Weiss / Eiche
 Blanc / Chêne



AM 15*
 Blanco / Cristal pintado negro
 White / Glass painted in black
 Weiss / Schwarz eingefärbtes glas
 Blanc / Verre peint en noir

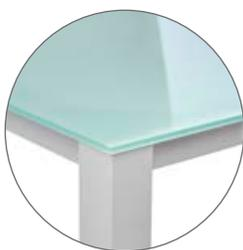

AM 25*
 Blanco / Cristal pintado blanco
 White / Glass painted in white
 Weiss / Weiss eingefärbtes glas
 Blanc / Verre peint en blanc



*Bajo pedido / on request



AY 01
Antracita / Haya
Anthracite / Beech
Anthrazit / Buche
Anthracite / Hêtre



AY 02
Antracita / Gris
Anthracite / Grey
Anthrazit / Grau
Anthracite / Gris



AY 04
Antracita / Blanco
Anthracite / White
Anthrazit / Weiss
Anthracite / Blanc

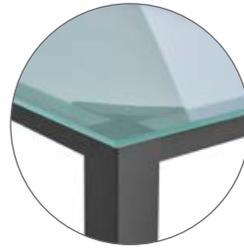

AY 05
Antracita / Cristal translúcido
Anthracite / Translucent glass
Anthrazit / Satinierte glas
Anthracite / Translucide verre



AY 08
Antracita / Roble
Anthracite / Oak
Anthrazit / Eiche
Anthracite / Chêne



AY 15*
Antracita / Cristal pintado negro
Anthracite / Glass painted in black
Anthrazit / Schwarz eingefärbtes glas
Anthracite / Verre peint en noir

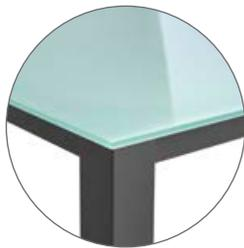

AY 25*
Antracita / Cristal pintado blanco
Anthracite / Glass painted in white
Anthrazit / Weiss eingefärbtes glas
Anthracite / Verre peint en blanc



2001. AY01

*Bajo pedido / on request

CROMADO • CHROMED • VERCHROMT • CHROMÉ



AE 01
Cromado / Haya
Chrome / Beech
Chrom / Buche
Chrome / Hêtre



AE 02
Cromado / Gris
Chrome / Grey
Chrom / Grau
Chrome / Gris



AE 04
Cromado / Blanco
Chrome / White
Chrom / Weiss
Chrome / Blanc

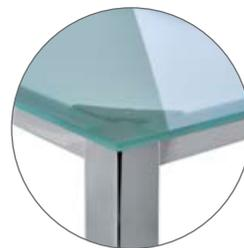

AE 05
Cromado / Cristal translúcido
Chrome / Translucent glass
Chrom / Satinierte glas
Chrome / Translucide verre



AE 08
Cromado / Roble
Chrome / Oak
Chrom / Eiche
Chrome / Chêne



AE 15*
Cromado / Cristal pintado negro
Chrome / Glass painted in black
Chrom / Schwarz eingefärbtes glas
Chrome / Verre peint en noir



AE 25*
Cromado / Cristal pintado blanco
Chrome / Glass painted in white
Chrom / Weiss eingefärbtes glas
Chrome / Verre peint en blanc



Cromado
Chromed
Verchromt
Chromé

2001. AE01

*Bajo pedido / on request

ACCESORIOS

ACCESSORIES • ZUBEHÖR • ACCESSOIRES



1 Faldón metálico
Modesty panel
Metallblende
Voile de fond en métal

2 Electrificación
Wiring
Kabelkette
Système électrique

3 Soporte cpu
CPU support
CPU Träger
Support d'unité centrale

4 Pasacables
Cable duct
Kabelführung
Passe-câbles

5 Separador
Divider
Trennblenden
Séparateur

6 Caja conexión
Cable management box
Mehrfachsteckdose
Boîtier de branchements





ref. 2939/W/S/Y - 2940/W/S/Y
2941/W/S/Y - 2942/W/S/Y

1 FALDÓN METÁLICO MESA / MODESTY PANEL / METALLBLENDE / VOILE DE FOND EN MÉTAL

Ref. aluminio / aluminium	Ref. blanco / white weiss / blanc	Ref. plata / silver silber / argent	Ref. antracita / anthracite anthrazit / anthracite	cm (producto / product)	Medidas mesa / Table size	kg / m ³ (embalaje / pack)	Nº bultos / packs
2939	2939W	2939S	2939Y	117x30	140	5 kg / 0,015 m ³	1
2940	2940W	2940S	2940Y	137x30	160	5,5 kg / 0,018 m ³	1
2941	2941W	2941S	2941Y	157x30	180	6 kg / 0,020 m ³	1
2942	2942W	2942S	2942Y	177x30	200	6,5 kg / 0,023 m ³	1



ref. 2901⁽¹⁾

2 ELECTRIFICACIÓN / WIRING / KABELKETTE/ SYSTÈME ÉLECTRIQUE

Ref.	cm (producto / product)	kg / m ³ (embalaje / pack)	Nº bultos / packs	Acabados / Finishes Dekore / Finitons
2901 ⁽¹⁾	46x46x7	2 kg / 0,014 m ³	1	gris / grey / grau / gris

⁽¹⁾sólo tableros melamina / only melamine boards



ref. 2943/W/Y/S⁽¹⁾

3 SOPORTE CPU / CPU SUPPORT / CPU TRÄGER / SUPPORT D'UNITÉ CENTRALE

Ref.	cm (producto / product)	kg / m ³ (embalaje / pack)	Nº bultos / packs	Acabados / Finishes Dekore / Finitons
2943 ⁽¹⁾	25x45x55	9 kg / 0,011 m ³	1	aluminio / aluminium
2943W ⁽¹⁾	25x45x55	9 kg / 0,011 m ³	1	blanco / white / weiss / blanc
2943Y ⁽¹⁾	25x45x55	9 kg / 0,011 m ³	1	antracita / anthracite / anthrazit / anthracite
2943S ⁽¹⁾	25x45x55	9 kg / 0,011 m ³	1	plata / silver / silber / argent

⁽¹⁾sólo tableros melamina / only melamine boards

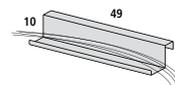

ref. 2921/W/Y/S⁽¹⁾

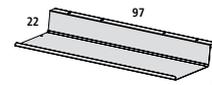

ref. 2922/W/Y/S⁽¹⁾⁽²⁾

Accesorio no disponible para mesas de 120 x 60 cm

4 PASACABLES / CABLE DUCT / KABELFÜHRUNG/ PASSE-CÂBLES

Ref.	cm (producto / product)	kg / m ³ (embalaje / pack)	Nº bultos / packs	Acabados / Finishes Dekore / Finitons
2921 ⁽¹⁾	49x10x6	1 kg / 0,002 m ³	1	aluminio / aluminium
2921W ⁽¹⁾	49x10x6	1 kg / 0,002 m ³	1	blanco / white / weiss / blanc
2921Y ⁽¹⁾	49x10x6	1 kg / 0,002 m ³	1	antracita / anthracite / anthrazit / anthracite
2921S ⁽¹⁾	49x10x6	1 kg / 0,002 m ³	1	plata / silver / silber / argent
2922 ⁽¹⁾⁽²⁾	97x22x6	3,5 kg / 0,015 m ³	1	aluminio / aluminium
2922W ⁽¹⁾⁽²⁾	97x22x6	3,5 kg / 0,015 m ³	1	blanco / white / weiss / blanc
2922Y ⁽¹⁾⁽²⁾	97x22x6	3,5 kg / 0,015 m ³	1	antracita / anthracite / anthrazit / anthracite
2922S ⁽¹⁾⁽²⁾	97x22x6	3,5 kg / 0,015 m ³	1	plata / silver / silber / argent

⁽¹⁾sólo tableros melamina / only melamine boards

⁽²⁾accesorio para mesas a partir de 140cm / Accessory to be used from 140cm tables

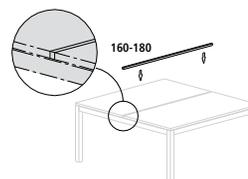

ref. 2960* - 2961* - 2960V* - 2961V*

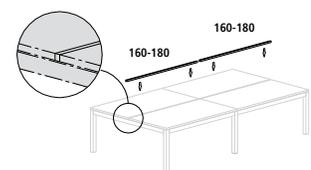

ref. 2962* - 2963* - 2962V* - 2963V*

EMBELLECEDOR MESA / TABLE COVER ABDECKLEISTE / EMBELLISSEUR DE TABLE

Ref. mesas melamina / melamine tables	Ref. mesas cristal / glass tables	Cms.	kg / m ³	Nº bultos / packs	Acabados / Finishes / Dekore / Finitons			
					AE Cromado Chromed	AD Aluminio Aluminium	AM Blanco White	AY Antracita Anthracite
2960* (1u)	2960V* (1u)	160	2 kg / 0,005 m ³	1	✓	✓	✓	✓
2961* (1u)	2961V* (1u)	180	2 kg / 0,005 m ³	1	✓	✓	✓	✓
2962* (2u)	2962V* (2u)	160	4 kg / 0,005 m ³	1	✓	✓	✓	✓
2963* (2u)	2963V* (2u)	180	4 kg / 0,005 m ³	1	✓	✓	✓	✓

* Bajo pedido / On request / Auf Anforderung / Sur demande.



Melamina / Melamine
Melamin / Mélamine



Cristal / Glass
Glas / Verre



Mesa doble - Mesas "L" dobles (ref. 2903AE / 2917)
Double table - Double L-Tables (ref. 2903AE / 2917)
Mehrfacharbeitstische - Mehrfacharbeitstische in L-Form (ref. 2903AE / 2917)
Double tables - Bureau en L à double (ref. 2903AE / 2917)

MELAMINA / MELAMINE / MELAMIN / MÉLAMINE

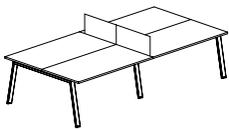

ref. 2905AE*

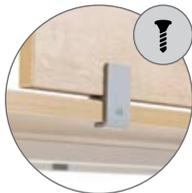

ref. 2905IE*

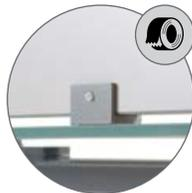

ref. 2905IV*

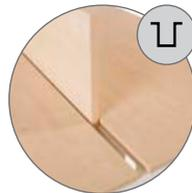
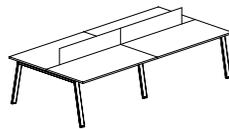

ref. 2903AE*

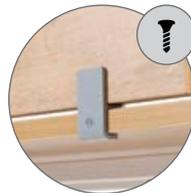

ref. 2903IE*

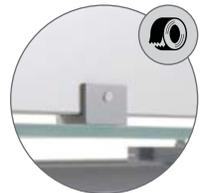
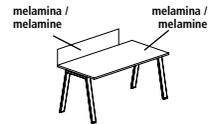

ref. 2903IV*

CRISTAL / GLASS / GLAS / VERRE

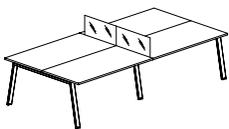

ref. 2916*



ref. 2916IE*

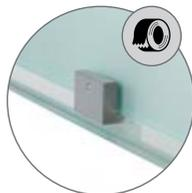
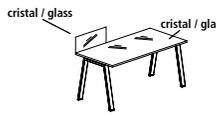

ref. 2916IV*

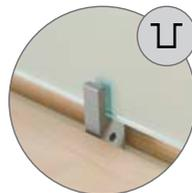
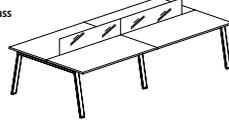

ref. 2917*



ref. 2917IE*

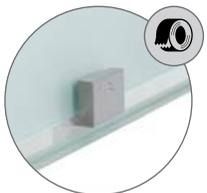
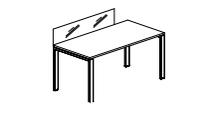

ref. 2917IV*

Ref.	cm (producto / product)	kg / m ³	N° Packs	Acabados / Finishes / Dekore / Finitons
2916* (1u)	70x40	7 kg / 0,020 m ³	1	Cristal translúcido / Translucent glass Satinerte glas / Translucide verre
2916IE* (1u)				
2916IV* (1u)				
2917* (1u)	136x40	14 kg / 0,053 m ³	1	
2917IE* (1u)				
2917IV* (1u)				
2905AE* (1u)	70x40	7 kg / 0,020 m ³	1	<div style="display: flex; justify-content: space-around; align-items: flex-start;"> <div style="text-align: center;"> ■ 01* Haya Beech </div> <div style="text-align: center;"> ■ 02* Gris Grey </div> <div style="text-align: center;"> ■ 04* Blanco White </div> <div style="text-align: center;"> ■ 08* Roble Oak </div> </div>
2905IE* (1u)				
2905IV* (1u)				
2903AE* (1u)	136x45	10 kg / 0,032 m ³	1	
2903IE* (1u)				
2903IV* (1u)				

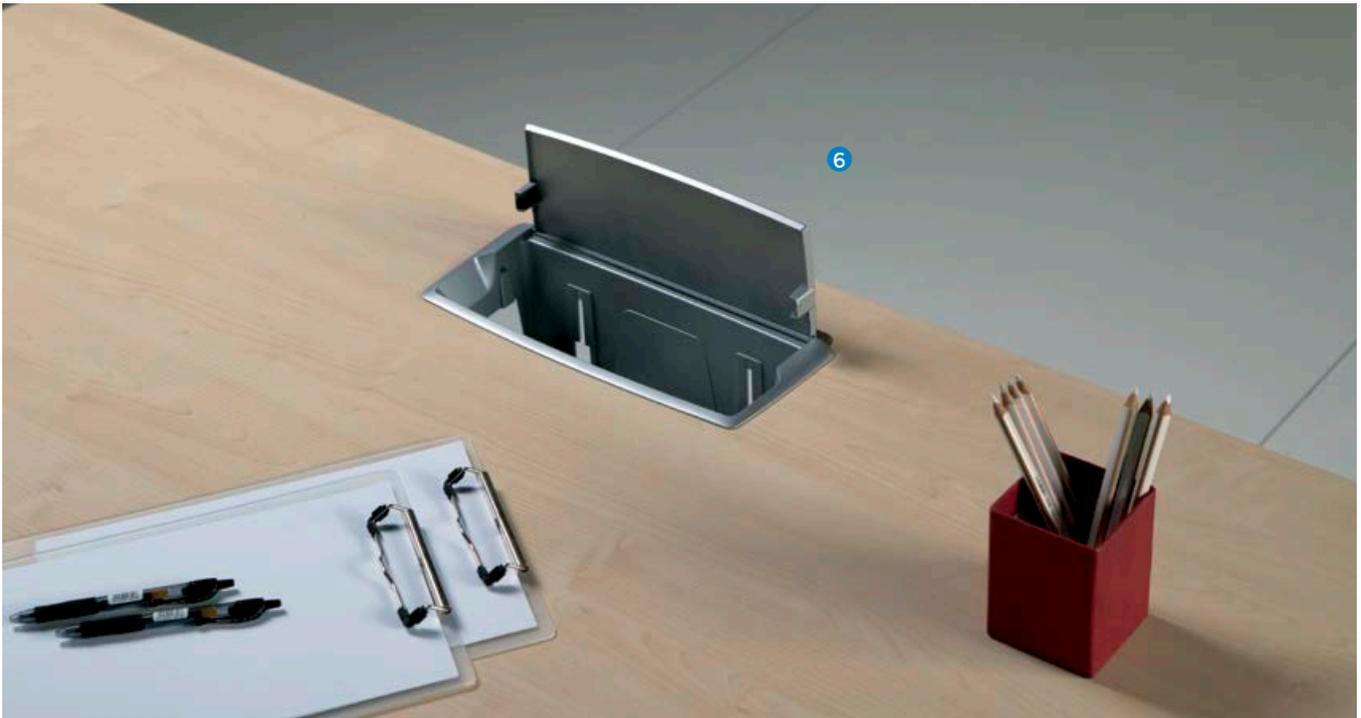

ref. 2964

2 shucko + 1 2RJ45 + 2m wiring/kabel

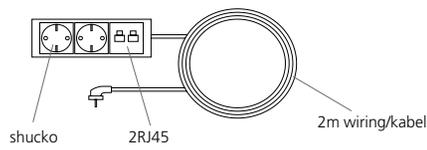

ref. 2965

vacío / empty / leere / vides

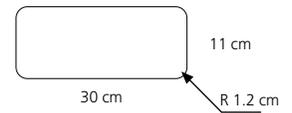

Dimensiones agujero / Hole sizes

6 CAJA CONEXIÓN / CABLE MANAGEMENT BOX / MEHRFACHSTECKDOSE / BOÎTIER DE BRANCHEMENTS

Ref.	cm (producto / product)	kg / m ³ (embalaje / pack)	Nº bultos / packs	Acabados / Finishes / Dekore / Finitons
2964	32x13x10	1,2 kg / 0,060 m ³	1	gris / grey / grau / gris
2965	32x13x10	0,5 kg / 0,060 m ³	1	gris / grey / grau / gris

No incluye mecanizado / Fixing not included / Montageservice auf Anfrage / Usinage et adaptation non compris



Agujero pasacables disponible bajo pedido
Wiring drill available on request

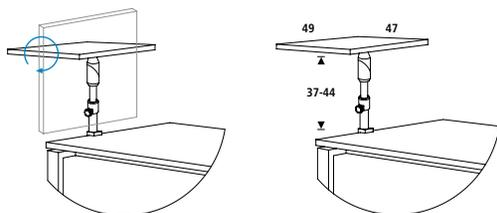

7 SEGUNDO NIVEL ABATIBLE / FOLDABLE SECOND LEVEL / ZWEITE EBENE ABKLAPPBAR / DEUXIÈME NIVEAU ARTICULÉ

Ref.	cm (producto / product)	kg / m ³ (embalaje / pack)	Nº bultos / packs
2906V19	50x50x11	4 kg / 0,021 m ³	1



**ACABADOS / FINISHES
DEKORE / FINITIONS**



01
Haya · Beech
Buche · Hêtre



02
Gris · Grey
Grau · Gris

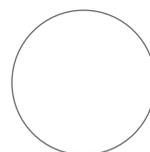

04
Blanco · White
Weiss · Blanc



08
Roble · Oak
Eiche · Chêne

**8 PIZARRA LACADA MAGNÉTICA PARA PANEL DIVISOR / MAGNETIC LACQUERED WHITEBOARD PANEL DIVIDER
LACKIERTE MAGNETTAFEL ALS TRENNPLATTE / TABLEAU LAQUÉ MAGNÉTIQUE POUR PANNEAU DIVISEUR**

Ref.	cm (producto / product)	kg / m ³ (embalaje / pack)	Nº bultos / packs	Acabados / Finishes / Dekore / Finitions
1900W	50x40x4	2 kg / 0,008 m ³	1	blanco / white / weiss / blanc

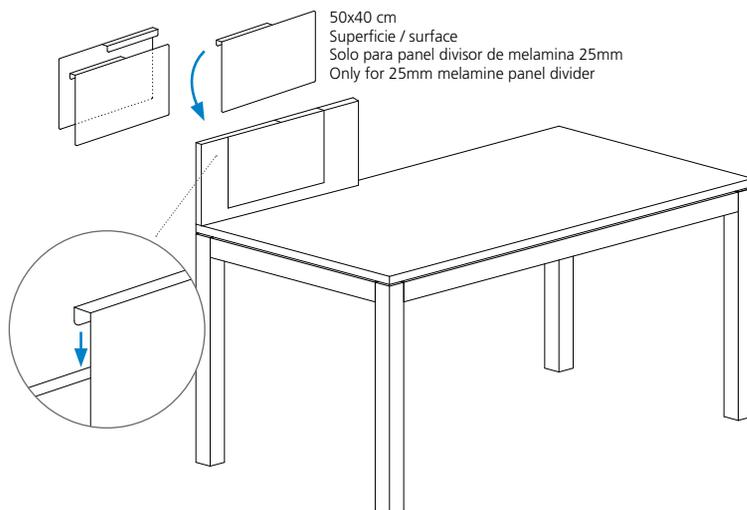

MESA

TABLE • TISCHE • BUREAUX

[ESP] Mesa de la gama Executive pensada para satisfacer las necesidades de los trabajos realizados de pie. Con una estructura inferior que permite almacenar objetos. Esta mesa puede ser utilizada como mostrador, mesa de trabajo o mesa de reunión en entornos de oficina e industriales.

[ENG] Executive range table designed to meet the needs of the work carried out while standing with a lower structure that allows this table to be stored. It can be used as a counter, work table, meeting table..... in the office and industrial environments.

[DE] Tisch der Produktreihe Executive, speziell entworfen, um die besonderen Anforderungen bei der Arbeit im Stehen zu erfüllen. Dank seines als Ablage nutzbaren Untergestells kann dieser Tisch als Tresen, Arbeitstisch, Konferenztisch usw. in Büros und Gewerberäumen verwendet werden.

[FR] Table de la gamme Executive pensée pour satisfaire aux besoins des tâches devant être réalisées debout. Avec une structure inférieure comportant des options de stockage, cette table peut être utilisée comme présentoir, table de travail, table de réunion, etc., aussi bien dans un bureau que dans un environnement industriel.



Ref.	cm (producto / product)	kg / m ³ (embalaje / pack)	Nº bultos / packs
2008	160x80x100	68 kg / 0,189 m ³	4

ACABADOS

FINISHES • DEKORE • FINITIONS



AD 01

Alumino / Haya · Aluminium / Beech
Aluminium / Buche · Aluminium / Hêtre



AD 02

Alumino / Gris · Aluminium / Grey
Aluminium / Grau · Aluminium / Gris



AD 04

Alumino / Blanco · Aluminium / White
Aluminium / Weiss · Aluminium / Blanc



AD 08

Alumino / Roble · Aluminium / Oak
Aluminium / Eiche · Aluminium / Chêne



AM 01

Blanco / Haya · White / Beech
Weiss / Buche · Blanc / Hêtre



AM 02

Blanco / Gris · White / Grey
Weiss / Grau · Blanc / Gris



AM 04

Blanco / Blanco · White / White
Weiss / Weiss · Blanc / Blanc



AM 08

Blanco / Roble · White / Oak
Weiss / Eiche · Blanc / Chêne

METAL

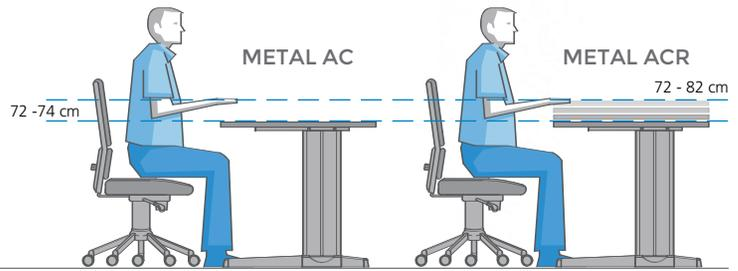

[ESP] SUPERFICIES DE MESA

Melamínico sobre aglomerado de 25 mm de grosor con canto de PVC de 2 mm. Acabados en haya, gris, roble y blanco. Superficies con cantos rectos.

COMPLEMENTOS

Soporte CPU metálico, separador (en melamina, cristal), sistema de electrificación vertical.

ESTRUCTURA

Estructura fija o regulable en distintos niveles. Realizada en plancha de acero plegada y estampada con acabado pintado epoxy según modelo. Con sistema de electrificación interna. Su sistema telescópico permite una regulación de altura de 100mm.

Para medidas y aplicaciones especiales, consultar a Rocada.

[ENG] TABLE TOPS

Melamine coated 25 mm particle board with 2 mm PVC edges. Beech, grey, oak and white finishes. Table tops with straight edges.

ACCESSORIES

Metal CPU support, divider (melamine, glass), vertical cable management system.

STRUCTURE

Fixed or adjustable to different levels. Made from folded, impressed sheet steel with painted epoxy finish. Internal electrification system. Its telescopic system enables height adjustment of 100 mm.

For special sizes and uses contact Rocada.

[DE] TISCHPLATTEN

Melaminbeschichtete Spanplatte (25mm) mit 2mm starkem Kunststoff - Umleimer. Dekorauswahl: Buche hell, Lichtgrau, Eiche.

ZUBEHÖR

CPU Träger, Sichtblende, Trennblenden (melaminbeschichtet oder aus Glas).

GESTELL

Lichtgrau pulverbeschichtete Stahlblechkonstruktion, Fußelemente aus Druckguss. Wahlweise mit fester Tischhöhe 720mm (Version AC) oder von 720 - 820mm höhenverstellbar (Version ACR) lieferbar. Beide Versionen mit separater Höhennivellierung (20mm) Integrierte Kabelkanäle mit Auslässen.

Sonderanfertigungen auf Anfrage.

[FR] PLATEAUX DE TABLE

Panneau de particules mélaminé de 25 mm d'épaisseur avec chant en PVC de 2 mm. Finitions hêtre, gris, chêne et blanc. Plateaux avec chants droits.

ACCESSOIRES

Support d'Unité centrale en métal, séparateur (en mélaminé, verre), système électrique vertical.

STRUCTURE

Structure fixe ou réglable sur différents niveaux. Réalisée en acier plié avec perforations, finitions peinture époxy. Système de passe câbles intégré. Système télescopique avec réglage de hauteur de 100 mm.

Veillez contacter Rocada pour des dimensions et applications spécifiques.















MESAS

TABLES • TISCHE • BUREAUX

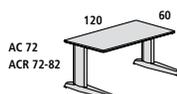

ref. 2000 ⁽²⁾



ref. 2001 - 2002
2003 - 2004

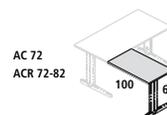

ref. 2102

Ref.	AC	ACR	cm (producto / product)	kg / m ³ (embalaje / packaging)	N° Packs
2000 ⁽²⁾	✓	✓	120x60	31 kg / 0,081 m ³	3
2001	✓	✓	140x80	40 kg / 0,111 m ³	3
2002	✓	✓	160x80	43 kg / 0,120 m ³	3
2003	✓	✓	180x80	47 kg / 0,128 m ³	3
2004	✓	✓	200x80	51 kg / 0,140 m ³	3
2102	✓	✓	100x60	25 kg / 0,060 m ³	3

(2) No admite ala auxiliar / Not suitable for wing table.

MESAS L

L-TABLES • TISCH IN L-FORM • BUREAU EN L

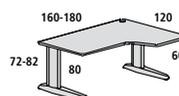

Derecha/ Right / Rechts / Droite
ref. 2051 - 2052

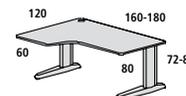

Izquierda / Left / Links / Gauche
ref. 2053 - 2054

Ref.	AC	ACR	cm (producto / product)	kg / m ³ (embalaje / packaging)	N° Packs
2051	✓	✓	160x120x80	50 kg / 0,128 m ³	3
2052	✓	✓	180x120x80	51 kg / 0,138 m ³	3
2053	✓	✓	160x120x80	51 kg / 0,138 m ³	3
2054	✓	✓	180x120x80	51 kg / 0,138 m ³	3
2945 (columna gris / grey column)	✓	✓	13x13x72	3 kg / 0,015 m ³	1
2945W (columna blanca / white column)	✓	✓	13x13x72	3 kg / 0,015 m ³	1
2945Y (columna antracita / anthracite column)	✓	✓	13x13x72	3 kg / 0,015 m ³	1

Agujero pasacables incluido. Wiring drill included.

Atención / Attention

Mesas L requieren buck altura mesa (sólo ref AC / ACW / ACY) o columna ref. 2945
L-table require high pedestals (only ref AC / ACW / ACY) or column ref 2945



ÁNGULO DE 90°

90° ANGLE • WINKEL 90° • ANGLE DE 90°

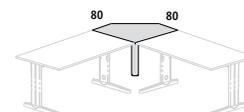

ref. 2907AG
Ángulo 90° / Angle 90°

Ref.	cm (producto / product)	kg / m ³ (embalaje / packaging)	N° Packs	Acabados / Finishes Dekore / Finitions
2907AG (aluminio / aluminium)	80x80	15 kg / 0,040 m ³	2	<div style="display: flex; justify-content: space-around;"> <div style="text-align: center;">01 Haya Beech</div> <div style="text-align: center;">02 Gris Grey</div> <div style="text-align: center;">04 Blanco White</div> <div style="text-align: center;">08 Roble Oak</div> </div>
2907AGW (blanco / white)	80x80	15 kg / 0,040 m ³	2	
2907AGY (antracita / anthracite)	80x80	15 kg / 0,040 m ³	2	

Estructura: nuevo acabado antracita
Structure: new finish in anthracite

ACABADOS

FINISHES • DEKORE • FINITIONS



AC 01 / ACR 01
Aluminio / Haya
Aluminium / Beech
Aluminium / Buche
Aluminium / Hêtre



AC 02 / ACR 02
Aluminio / Gris
Aluminium / Grey
Aluminium / Grau
Aluminium / Gris



AC 04 / ACR 04
Aluminio / Blanco
Aluminium / White
Aluminium / Weiss
Aluminium / Blanc



AC 08 / ACR 08
Aluminio / Roble
Aluminium / Oak
Aluminium / Eiche
Aluminium / Chêne



ACW 01 / ACRW 01
Blanco / Haya
White / Beech
Weiss / Buche
Blanc / Hêtre



ACW 02 / ACRW 02
Blanco / Gris
White / Grey
Weiss / Grau
Blanc / Gris



ACW 04 / ACRW 04
Blanco / Blanco
White / White
Weiss / Weiss
Blanc / Blanc



ACW 08 / ACRW 08
Blanco / Roble
White / Oak
Weiss / Eiche
Blanc / Chêne



ACY 01 / ACRY 01
Antracita / Haya
Anthracite / Beech
Anthrazit / Buche
Anthracite / Hêtre



ACY 02 / ACRY 02
Antracita / Gris
Anthracite / Grey
Anthrazit / Grau
Anthracite / Aluminium



ACY 04 / ACRY 04
Antracita / Blanco
Anthracite / White
Anthrazit / Weiss
Anthracite / Blanc



ACY 08 / ACRY 08
Antracita / Roble
Anthracite / Oak
Anthrazit / Eiche
Anthracite / Chêne



ACR: Estructura regulable Adjustable structure



regulable / adjustable
einstellbar / réglable 10 cm.



2001. AC01

ACCESORIOS

ACCESSORIES • ZUBEHÖR • ACCESSOIRES



1 Faldón metálico mesa
Modesty panel
Metallblende
Voile de fond en métal

2 Soporte cpu
CPU support
CPU träger
Support d'unité centrale

3 Separador
Divider
Trennblenden
Séparateur

4 Caja conexión
Cable management box
Mehrfachsteckdose
Boîtier de branchements





Estructura y cableado
Structure and wiring

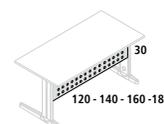

1 FALDÓN METÁLICO MESA / MODESTY PANEL / METALLBLLENDE / VOILE DE FOND EN MÉTAL

ref. 2935 - 2936 - 2937 - 2938

Ref. aluminio / aluminium	Ref. blanco / white weiss / blanc	Ref. antracita / anthracite anthrazit / anthracite	cm (producto / product)	Medidas mesa / Table size	kg / m ³ (embalaje / pack)	Nº bultos / packs
2935	2935W	2935Y	120x30	140 cm	6 kg / 0,015 m ³	1
2936	2936W	2936Y	140x30	160 cm	6,5 kg / 0,018 m ³	1
2937	2937W	2937Y	160x30	180 cm	7 kg / 0,020 m ³	1
2938	2938W	2938Y	180x30	200 cm	8 kg / 0,023 m ³	1

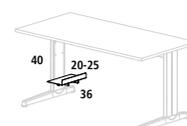

2 SOPORTE CPU / CPU SUPPORT / CPU TRÄGER / SUPPORT D'UNITÉ CENTRALE

ref. 2944

Ref. aluminio / aluminium	Ref. blanco / white weiss / blanc	Ref. antracita / anthracite anthrazit / anthracite	cm (producto / product)	Medidas mesa / Table size	kg / m ³ (embalaje / pack)	Nº bultos / packs
2944	2944W	2944Y	40x36x20-25	4 kg / 0,043 m ³	1	1



Cristal / Glass
Glas / Verre



Melamina / Melamine
Melamin / Mèlamine

NEW

3 SEPARADOR / DIVIDER / TRENNBLENDEN / SÉPARATEUR

MELAMINA / MELAMINE / MELAMIN / MÉLAMINE

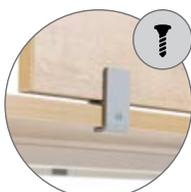
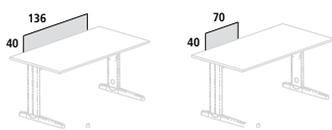

ref. 2905IE* / ref. 2903IE*

CRISTAL / GLASS / GLAS / VERRE

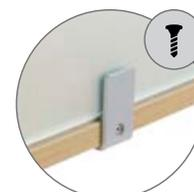
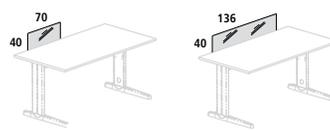

ref. 2916IE* / ref. 2917IE*

Ref.	cm (producto / product)	kg / m ³ (embalaje / packaging)	Nº Packs	Acabados / Finishes Dekore / Finitons
2916IE* (1u)	70x40	7 kg / 0,020 m ³	1	Cristal translúcido / Translucent glass Satinierde glas / Translucide verre
2917IE* (1u)	136x40	14 kg / 0,053 m ³	1	
2905IE* (1u)	70x40	7 kg / 0,020 m ³	1	 01* Haya Beech 02* Gris Grey 04* Blanco White 08* Roble Oak
2903IE* (1u)	136x40	10 kg / 0,032 m ³	1	

(*) Bajo pedido / On request / Auf Anforderung / Sur demande

4 CAJA CONEXIÓN / CABLE MANAGEMENT BOX / MEHRFACHSTECKDOSE / BOÎTIER DE BRANCHEMENTS



ref. 2964

2 shucko + 1 2RJ45 + 2m wiring/kabel

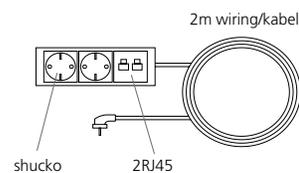

ref. 2965

vacio / empty / leere / vides

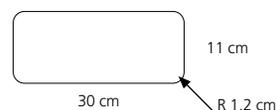

Dimensiones agujero / Hole sizes

Ref.	cm (producto / product)	kg / m ³ (embalaje / packaging)	Nº Packs	Acabados / Finishes / Dekore / Finitons
2964	32x13x10	1,2 kg / 0,060 m ³	1	gris / grey / grau / gris
2965	32x13x10	0,5 kg / 0,060 m ³	1	gris / grey / grau / gris

No incluye mecanizado / Fixing not included / Montageservice auf Anfrage / Usinage et adaptation non compris

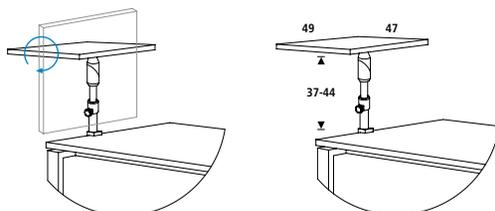

5 SEGUNDO NIVEL ABATIBLE / FOLDABLE SECOND LEVEL / ZWEITE EBENE ABKLAPPBAR / DEUXIÈME NIVEAU ARTICULÉ

Ref.	cm (producto / product)	kg / m ³ (embalaje / pack)	Nº bultos / packs
2906V19	50x50x11	4 kg / 0,021 m ³	1



ACABADOS / FINISHES
DEKORE / FINITIONS



01
Haya · Beech
Buche · Hêtre



02
Gris · Grey
Grau · Gris

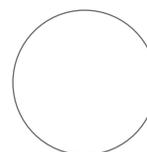

04
Blanco · White
Weiss · Blanc



08
Roble · Oak
Eiche · Chêne

6 PIZARRA LACADA MAGNÉTICA PARA PANEL DIVISOR / MAGNETIC LACQUERED WHITEBOARD PANEL DIVIDER
LACKIERTE MAGNETTAFEL ALS TRENNPLATTE / TABLEAU LAQUÉ MAGNÉTIQUE POUR PANNEAU DIVISEUR

Ref.	cm (producto / product)	kg / m ³ (embalaje / pack)	Nº bultos / packs	Acabados / Finishes / Dekore / Finitions
1900W	50x40x4	2 kg / 0,008 m ³	1	blanco / white / weiss / blanc

6

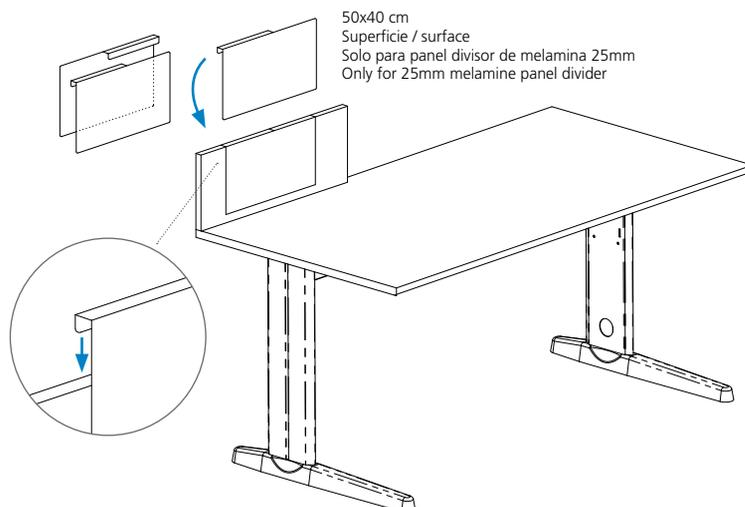

WORK



[ESP] SUPERFICIES DE MESA

Melamínico sobre aglomerado de 25 mm de grosor con canto de PVC de 2 mm. Acabados en haya, gris, roble y blanco. Superficies con cantos rectos.

COMPLEMENTOS

Soporte CPU metálico, separador (melamina, cristal), sistema de electrificación vertical y horizontal.

ESTRUCTURA MELAMINA

Estructura melamínica con sistema de regulación independiente (20 mm). Melamínico sobre aglomerado de 25 mm de grosor con canto de PVC de 2 mm de grosor. Acabados en haya, aluminio, blanco y roble. Estructura con cantos redondeados.

Para medidas y aplicaciones especiales, consultar a Rocada.

[ENG] TABLE TOPS

Melamine coated 25 mm particle board with 2 mm PVC edges. Beech, grey, oak and white finishes. Table tops with straight edges.

ACCESSORIES

Metal CPU support, divider, (melamine, glass), horizontal and vertical cable management system.

MELAMINE STRUCTURE

Melamine structure with independent adjustment system (20 mm). Melamine coated 25 mm particle board with 2 mm PVC edges. Beech, aluminium and white finishes. Structure with rounded edges.

For special sizes and uses contact Rocada.

[DE] TISCHPLATTEN

Melaminbeschichtete Spanplatte (25mm) mit 2mm starkem Kunststoff - Umleimer. Dekorauswahl: Buche hell, Lichtgrau, Eiche.

ZUBEHÖR

CPU Träger, Trennblenden (melaminbeschichtet), horizontale und vertikale Kabelführungen.

WANGENGESTELL

Wangenkonstruktion aus melaminbeschichteter Spanplatte (25mm) mit Kunststoffumleimer (2mm). Dekorvarianten wahlweise Alufarben oder Buche hell.

Sonderanfertigungen auf Anfrage.

[FR] PLATEAUX DE TABLE

Panneau de particules mélaminé de 25 mm d'épaisseur avec chant en PVC de 2 mm. Finitions hêtre, gris, chêne et blanc. Plateaux avec chants droits.

ACCESSOIRES

Support Unité centrale métallique, séparateur (en mélaminé, verre), système électrique vertical et horizontal.

STRUCTURE MÉLAMINÉ

Structure mélaminée avec système de réglage indépendant (20 mm). Panneau de particules mélaminé de 25 mm d'épaisseur avec chant en PVC de 2 mm d'épaisseur. Finitions hêtre, aluminium, blanc et chêne. Structure avec chants arrondis.

Veillez contacter Rocada pour des dimensions et applications spécifiques.









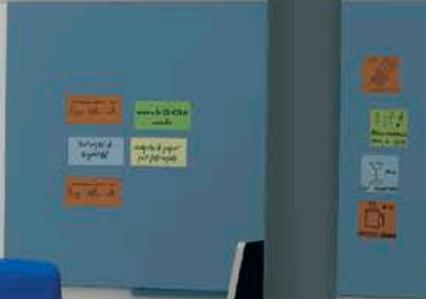
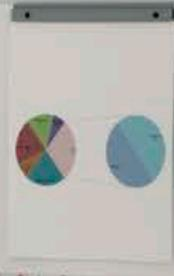





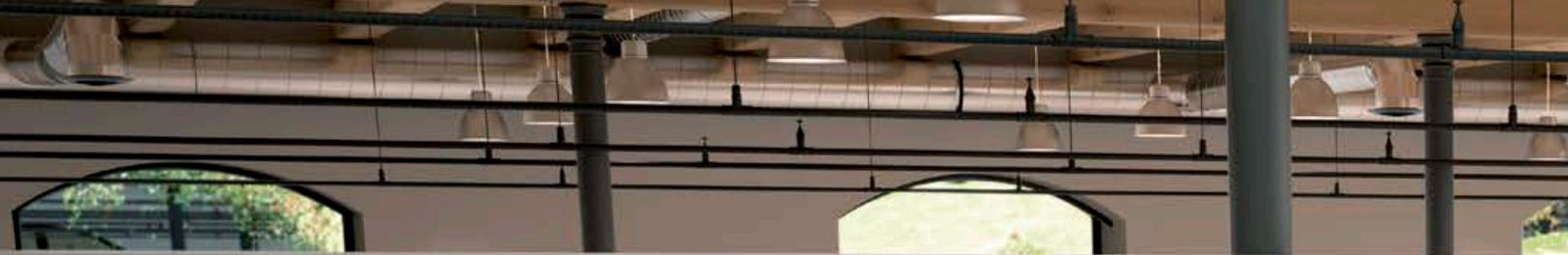



MESAS

TABLES • TISCHE • BUREAUX

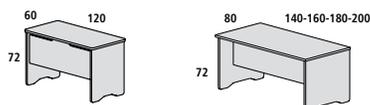

ref. 2000 ⁽²⁾ ref. 2001 - 2002 - 2003 - 2004

Ref.	cm (producto / product)	kg / m ³ (embalaje / packaging)	N° Packs
2000 ⁽²⁾	120x60	31,65 kg / 0,103 m ³	3
2001	140x80	45,15 kg / 0,115 m ³	3
2002	160x80	48,50 kg / 0,128 m ³	3
2003	180x80	51,60 kg / 0,148 m ³	3
2004	200x80	55,55 kg / 0,166 m ³	3

(2) No admite ala auxiliar / Not suitable for wing table.

ALA MESA

WING TABLE • ANSTELLTISCH • RETOUR

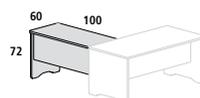

ref. 2102

Ref.	cm (producto / product)	kg / m ³ (embalaje / packaging)	N° Packs
2102	100x60	28 kg / 0,076 m ³	1

MESAS L

L-TABLES • TISCH IN L-FORM • BUREAU EN L

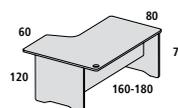

Derecha / Right / Rechts / Droite
ref. 2051 - 2052

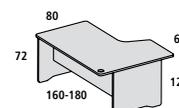

Izquierda / Left / Links / Gauche
ref. 2053 - 2054

Ref.	cm (producto / product)	kg / m ³ (embalaje / packaging)	N° Packs
2051	160x120x80	57 kg / 0,224 m ³	3
2052	180x120x80	64 kg / 0,243 m ³	3
2053	160x120x80	57 kg / 0,224 m ³	3
2054	180x120x80	64 kg / 0,243 m ³	3

Agujero pasacables incluido. Wiring drill included.

ÁNGULO DE 90°

90° ANGLE • WINKEL 90° • ANGLE DE 90°

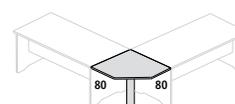

ref. 2907AG*
Ángulo 90° / Angle 90°

Ref.	cm (producto / product)	kg / m ³ (embalaje / packaging)	N° Packs	Acabados / Finishes / Dekore / Finitions				
2907AG	80x80	15 kg / 0,040 m ³	2	<table border="0"> <tr> <td>01 Haya Beech</td> <td>02 Gris Grey</td> <td>04 Blanco White</td> <td>08 Roble Oak</td> </tr> </table>	01 Haya Beech	02 Gris Grey	04 Blanco White	08 Roble Oak
01 Haya Beech	02 Gris Grey	04 Blanco White	08 Roble Oak					
2907AGW	80x80	15 kg / 0,040 m ³	2					



2907AG - Columna gris / Grey column
2907AGW - Columna blanca / White column

ACABADOS

FINISHES / DEKORE / FINITIONS



AA 01
Haya / Haya · Beech / Beech
Buche / Buche · Hêtre / Hêtre



AA 02
Haya / Gris · Beech / Grey
Buche / Grau · Hêtre / Gris



AA 04
Haya / Blanco · Beech / White
Buche / Weiss · Hêtre / Blanc



AA 08
Haya / Roble · Beech / Oak
Buche / Eiche · Hêtre / Chêne



AB 01
Aluminio / Haya · Aluminium / Beech
Aluminium / Buche · Aluminium / Hêtre



AB 02
Aluminio / Gris · Aluminium / Grey
Aluminium / Grau · Aluminium / Gris



AB 04
Aluminio / Blanco · Aluminium / White
Aluminium / Weiss · Aluminium / Blanc



AB 08
Aluminio / Roble · Aluminium / Oak
Aluminium / Eiche · Aluminium / Chêne



AW 01
Blanco / Haya · White / Beech
Weiss / Buche · Blanc / Hêtre



AW 02
Blanco / Gris · White / Grey
Weiss / Grau · Blanc / Gris



AW 04
Blanco / Blanco · White / White
Weiss / Weiss · Blanc / Blanc



AW 08
Blanco / Roble · White / Oak
Weiss / Eiche · Blanc / Chêne



AR 01
Roble / Haya · Oak / Beech
Eiche / Buche · Chêne / Hêtre



AR 02
Roble / Gris · Oak / Grey
Eiche / Grau · Chêne / Gris



AR 04
Roble / Blanco · Oak / White
Eiche / Weiss · Chêne / Blanc



AR 08
Roble / Roble · Oak / Oak
Eiche / Eiche · Chêne / Chêne



ACCESORIOS

ACCESSORIES / ZUBEHÖR / ACCESSOIRES



1 Electrificación
Wiring
Kabelkette
Système électrique

2 Pasacables
Cable duct
Kabelführung
Passe-câbles

3 Soporte cpu
CPU support
CPU Träger
Support d'unité centrale

4 Separador
Divider
Trennblenden
Séparateur

5 Caja conexión
Cable management box
Mehrfachsteckdose
Boîtier de branchements

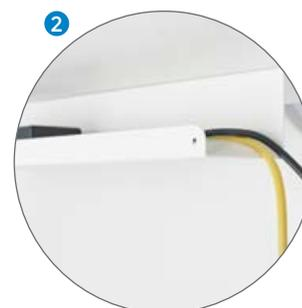

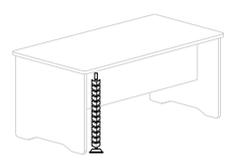
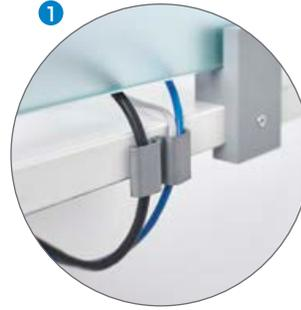

ref. 2901

1 ELECTRIFICACIÓN / WIRING / KABELKETTE/ SYSTÈME ÉLECTRIQUE

Ref.	cm (producto / product)	kg / m ³ (embalaje / packaging)	Nº Packs	Acabados / Finishes Dekore / Finitons
2901	100	2 kg / 0,014 m ³	1	gris / grey / grau / gris

2 PASACABLES / CABLE DUCT / KABELFÜHRUNG/ PASSE-CÂBLES

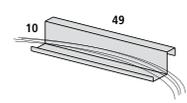

ref. 2921/W/Y/S

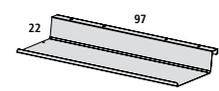

ref. 2922/W/Y/S

Ref.	cm (producto / product)	kg / m ³ (embalaje / packaging)	Nº Packs	Acabados / Finishes Dekore / Finitons
2921	49x10x6	1 kg / 0,002 m ³	1	gris / grey / grau / gris
2921W	49x10x6	1 kg / 0,002 m ³	1	blanco / white / weiss / blanc
2922	97x22x6	3,5 kg / 0,015 m ³	1	gris / grey / grau / gris
2922W	97x22x6	3,5 kg / 0,015 m ³	1	blanco / white / weiss / blanc

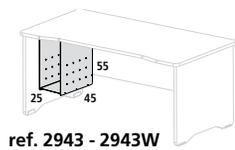

ref. 2943 - 2943W

3 SOPORTE CPU / CPU SUPPORT / CPU TRÄGER / SUPPORT D'UNITÉ CENTRALE

Ref.	cm (producto / product)	kg / m ³ (embalaje / packaging)	Nº Packs	Acabados / Finishes Dekore / Finitons
2943	55x45x25	9 kg / 0,011 m ³	1	gris / grey / grau / gris
2943W	55x45x25	9 kg / 0,011 m ³	1	blanco / white / weiss / blanc



4 SEPARADOR / DIVIDER / TRENNBLENDEN / SÉPARATEUR

MELAMINA / MELAMINE / MELAMIN / MÉLAMINE

CRISTAL / GLASS / GLAS / VERRE

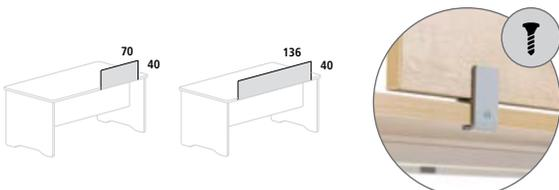

ref. 2905IE* / ref. 2903IE*

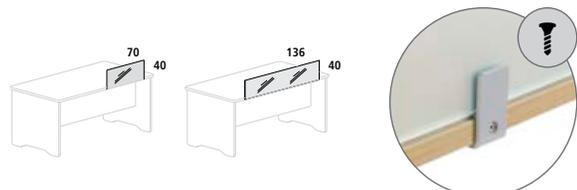

ref. 2916IE* / ref. 2917IE*

Ref.	cm (producto / product)	kg / m ³ (embalaje / packaging)	Nº Packs	Acabados / Finishes / Dekore / Finitons												
2916IE* (1u)	70x40	7 kg / 0,020 m ³	1	Cristal translúcido / Translucent glass Satinierde glas / Translucide verre												
2917IE* (1u)	136x40	14 kg / 0,053 m ³	1													
2905IE* (1u)	70x40	7 kg / 0,020 m ³	1	<table border="0"> <tr> <td>01*</td> <td>02*</td> <td>04*</td> <td>08*</td> </tr> <tr> <td>Haya</td> <td>Gris</td> <td>Blanco</td> <td>Roble</td> </tr> <tr> <td>Beech</td> <td>Grey</td> <td>White</td> <td>Oak</td> </tr> </table>	01*	02*	04*	08*	Haya	Gris	Blanco	Roble	Beech	Grey	White	Oak
01*	02*	04*	08*													
Haya	Gris	Blanco	Roble													
Beech	Grey	White	Oak													
2903IE* (1u)	136x40	10 kg / 0,032 m ³	1													

(*) Bajo pedido / On request / Auf Anforderung / Sur demande

5 CAJA CONEXIÓN / CABLE MANAGEMENT BOX / MEHRFACHSTECKDOSE / BOÎTIER DE BRANCHEMENTS

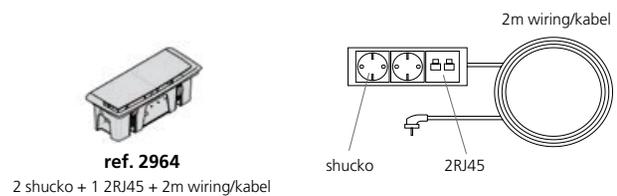

ref. 2964
2 shucko + 1 2RJ45 + 2m wiring/kabel

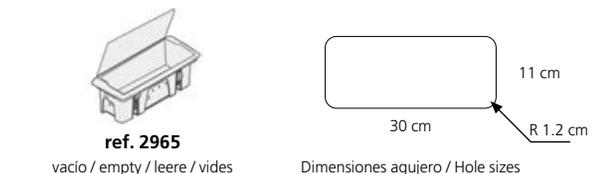

ref. 2965
vacío / empty / leere / vides

Dimensiones agujero / Hole sizes

Ref.	cm (producto / product)	kg / m ³ (embalaje / packaging)	Nº Packs	Acabados / Finishes / Dekore / Finitons
2964	32x13x10	1,2 kg / 0,060 m ³	1	gris / grey / grau / gris
2965	32x13x10	0,5 kg / 0,060 m ³	1	gris / grey / grau / gris

No incluye mecanizado / Fixing not included / Montageservice auf Anfrage / Usinage et adaptation non compris

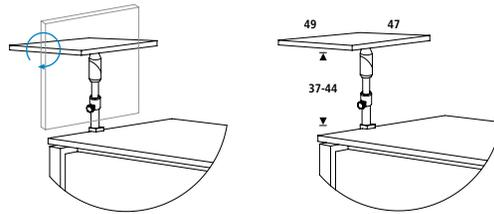

6 SEGUNDO NIVEL ABATIBLE / FOLDABLE SECOND LEVEL / ZWEITE EBENE ABKLAPPBAR / DEUXIÈME NIVEAU ARTICULÉ

Ref.	cm (producto / product)	kg / m ³ (embalaje / pack)	Nº bultos / packs
2906V19	50x50x11	4 kg / 0,021 m ³	1



ACABADOS / FINISHES
DEKORE / FINITIONS



01
Haya · Beech
Buche · Hêtre



02
Gris · Grey
Grau · Gris

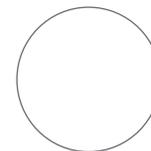

04
Blanco · White
Weiss · Blanc



08
Roble · Oak
Eiche · Chêne

7 PIZARRA LACADA MAGNÉTICA PARA PANEL DIVISOR / MAGNETIC LACQUERED WHITEBOARD PANEL DIVIDER
LACKIERTE MAGNETTAFEL ALS TRENNPLATTE / TABLEAU LAQUÉ MAGNÉTIQUE POUR PANNEAU DIVISEUR

Ref.	cm (producto / product)	kg / m ³ (embalaje / pack)	Nº bultos / packs	Acabados / Finishes / Dekore / Finitions
1900W	50x40x4	2 kg / 0,008 m ³	1	blanco / white / weiss / blanc

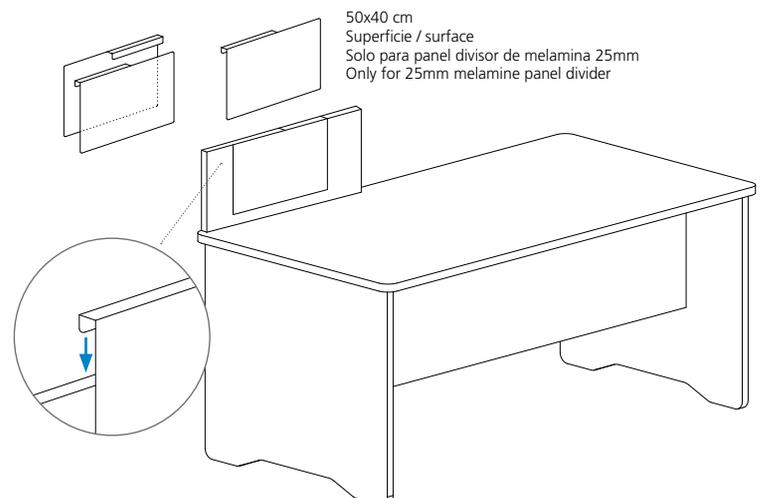

E-TABLE

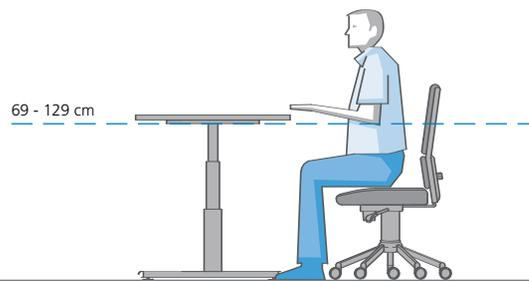

[ESP] SUPERFICIES DE MESA

Melamínico sobre aglomerado de 25 mm de grosor con canto de PVC de 2 mm. Acabados en haya, gris, roble y blanco. Superficies con cantos rectos.

ESTRUCTURA METÁLICA

Estructura compuesta de columnas de 3 niveles regulable en altura mediante mecanismo eléctrico. Realizada en tubo y chapa de acero plegada y estampada con acabado pintado epoxy. Pies con niveladores incluidos. El sistema telescópico permite una regulación de altura de 600mm.

Para medidas y aplicaciones especiales, consultar a Rocada.

[ENG] TABLE TOPS

25 mm melamine coated particle board with 2 mm PVC edges. Beech, grey, oak and white finishes. Table tops with straight edges.

METALLIC STRUCTURE

Structure composed of 3-level columns, adjustable in height by means of an electrical mechanism. Made of steel tube and folded and stamped sheet metal finished in epoxy paint. Feet include levelling devices. The telescopic system allows for 600mm of height adjustment.

Central beam made of 2 mm folded sheet steel with several openings for correct electrical wiring.

For special sizes and uses contact Rocada.

[DE] TISCH- / ABSCHLUSSPLATTE

Melaminbeschichtete Spanplatte 25 mm, mit 2 mm Kunststoffumleimer. Serienmäßig Dekorvarianten Buche hell und Lichtgrau.

T-Fuß-GESTELL

Elektrisch höhenverstellbarer Schreibtisch mit Teleskop-Stahlrohrgestell.

Stufenlose Höhenverstellung von 69 -129cm.

Die Quertraverse aus 2 mm starkem gefalztem Stahlblech verleiht dem Tisch nicht nur hohe Stabilität, sondern bietet Platz für eine bequeme und sichere Verkabelung.

Sonderanfertigungen auf Anfrage.

[FR] PLATEAUX DE TABLE

Panneau de particules mélaminé de 25 mm d'épaisseur avec chant en PVC de 2 mm. Finitions hêtre, gris, chêne et blanc. Plateaux avec chants droits.

STRUCTURE MÉTALLIQUE

Structure composée de 3 niveaux réglables en hauteur, au moyen d'un mécanisme électrique. Réalisée en tube et plaque d'acier pliée et gaufrée avec une finition peinture époxy. Pieds avec niveaux inclus. Le système télescopique permet un réglage en hauteur de 600 mm. Barre centrale en tôle d'acier de 2 mm pliée avec plusieurs ouvertures pour une électrification correcte

Veillez contacter Rocada pour des dimensions et applications spécifiques.



E-TABLE



Columna de 3 niveles
Three level column



Dispositivo de regulación de altura
Height adjustable device

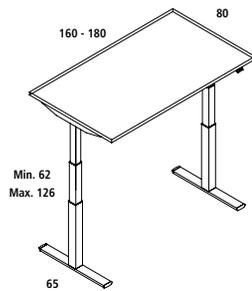

MESAS

TABLE • TISCHE • BUREAUX

Ref.	cm (producto / product)	kg / m ³ (embalaje / packaging)	Nº bultos / packs
2002XCR	160x80	48,5 kg / 0,098 m ³	3
2003XCR	180x80	52,5 kg / 0,102 m ³	3

ACABADOS

FINISHES • DEKORE • FINITIONS



XCR 01

Aluminio / Haya
Aluminium / Beech
Aluminium / Buche
Aluminium / Hêtre



XCR 02

Aluminio / Gris
Aluminium / Grey
Aluminium / Grau
Aluminium / Gris



XCR 04

Aluminio / Blanco
Aluminium / White
Aluminium / Weiss
Aluminium / Blanc



XCR 08

Aluminio / Roble
Aluminium / Oak
Aluminium / Eiche
Aluminium / Chêne



2002. XCR01

Regulación eléctrica según norma EN62233 2008
230V - 50Hz
Cable de alimentación Shucko de 3 m

Electrical unit by norms EN62233 2008
230V - 50Hz
3 m wiring (Shucko)





Melamina / Melamine
Melamin / Mélamine



Cristal / Glass
Glas / Verre

1 SEPARADOR / DIVIDER / TRENNBLENDEN / SÉPARATEUR

MELAMINA / MELAMINE / MELAMIN / MÉLAMINE

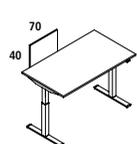

ref. 2905IE*

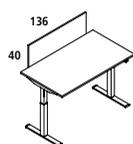

ref. 2903IE*

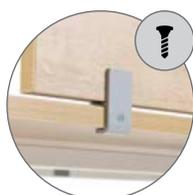

ref. 2905IE* / ref. 2903IE*

CRISTAL / GLASS / GLAS / VERRE

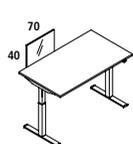

ref. 2916IE*

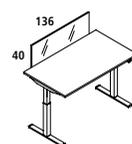

ref. 2917IE*

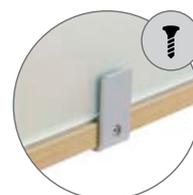

ref. 2916IE* / ref. 2917IE*

Ref.	cm (producto / product)	kg / m ³ (embalaje / packaging)	Nº Packs	Acabados / Finishes Dekore / Finitons
2916IE* (1u)	70x40	7 kg / 0,020 m ³	1	Cristal translúcido / Translucent glass Satinierter glas / Translucide verre
2917IE* (1u)	136x40	14 kg / 0,053 m ³	1	
2905IE* (1u)	70x40	7 kg / 0,020 m ³	1	 01* Haya Beech 02* Gris Grey 04* Blanco White 08* Roble Oak
2903IE* (1u)	136x40	10 kg / 0,032 m ³	1	

(*) Bajo pedido / On request / Auf Anforderung / Sur demande

2 CAJA CONEXIÓN / CABLE MANAGEMENT BOX / MEHRFACHSTECKDOSE / BOÎTIER DE BRANCHEMENTS



ref. 2964

2 shucko + 1 2RJ45 + 2m wiring/kabel

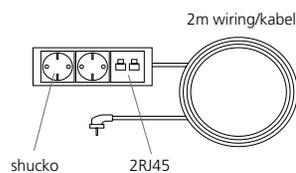

ref. 2965

vacio / empty / leere / vides

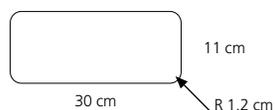

Dimensiones agujero / Hole sizes

Ref.	cm (producto / product)	kg / m ³ (embalaje / packaging)	Nº Packs	Acabados / Finishes / Dekore / Finitons
2964	32x13x10	1,2 kg / 0,060 m ³	1	gris / grey / grau / gris
2965	32x13x10	0,5 kg / 0,060 m ³	1	gris / grey / grau / gris

No incluye mecanizado / Fixing not included / Montageservice auf Anfrage / Usinage et adaptation non compris

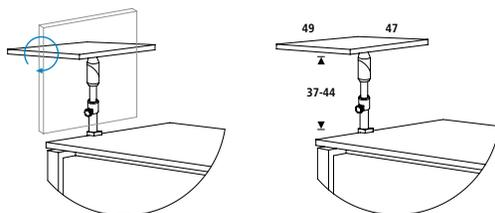

3 SEGUNDO NIVEL ABATIBLE / FOLDABLE SECOND LEVEL / ZWEITE EBENE ABKLAPPBAR / DEUXIÈME NIVEAU ARTICULÉ

Ref.	cm (producto / product)	kg / m ³ (embalaje / pack)	Nº bultos / packs
2906V19	50x50x11	4 kg / 0,021 m ³	1



ACABADOS / FINISHES
DEKORE / FINITIONS



01
Haya · Beech
Buche · Hêtre



02
Gris · Grey
Grau · Gris

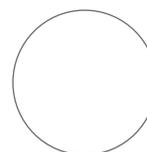

04
Blanco · White
Weiss · Blanc



08
Roble · Oak
Eiche · Chêne

4 PIZARRA LACADA MAGNÉTICA PARA PANEL DIVISOR / MAGNETIC LACQUERED WHITEBOARD PANEL DIVIDER
LACKIERTE MAGNETTAFEL ALS TRENNPLATTE / TABLEAU LAQUÉ MAGNÉTIQUE POUR PANNEAU DIVISEUR

Ref.	cm (producto / product)	kg / m ³ (embalaje / pack)	Nº bultos / packs	Acabados / Finishes / Dekore / Finitions
1900W	50x40x4	2 kg / 0,008 m ³	1	blanco / white / weiss / blanc

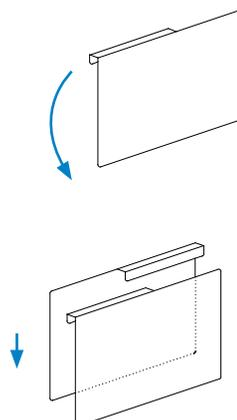

50x40 cm
Superficie / surface
Solo para panel divisor de melamina 25mm
Only for 25mm melamine panel divider

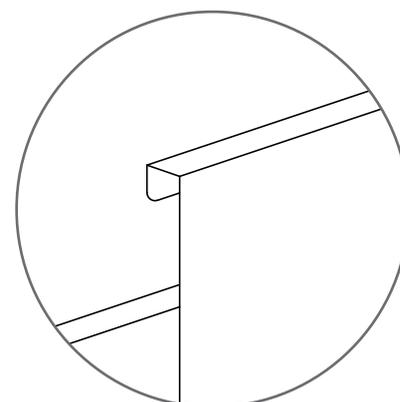

ACOUSTIC

[ESP] PANELES ACÚSTICOS

Gama de paneles acústicos que se adaptan a los requerimientos técnicos y estéticos de cada proyecto. Realizados en polímero técnico PET permite una excelente absorción acústica tanto para espacios públicos como privados. Los paneles acústicos son especialmente útiles para controlar las primeras reflexiones, así como el tiempo de reverberación en medias-altas y altas frecuencias. Permiten reducir el ruido ambiental en oficinas, salas de reuniones, call centers, salas de videoconferencia, etc. Disponible en diferentes medidas, colores y distintas formas de aplicación (de sobremesa, divisores de pie y para pared)

[ENG] ACOUSTIC PANELS

Range of acoustic panels that adapt to the technical and aesthetic requirements of each project. Made in PET, technical polymer allows excellent acoustic absorption for both public and private spaces. The acoustic panels are especially useful for controlling the first reflections, as well as the reverberation time in medium-high and high frequencies. They allow to reduce the environmental noise in offices, meeting rooms, call centers, video conferencing rooms, etc. Available in different sizes, colors and different forms (desk, dividers and wall dividers)

[DE] SCHALLDÄMMPLATTEN

Produktreihe an Schalldämmplatten, die sich ganz an die technischen und stilistischen Anforderungen des jeweiligen Projekts anpassen. Die Platten sind aus dem technischen Kunststoff PET gefertigt und bieten dadurch eine hervorragende Schallabsorption, sowohl in öffentlichen als auch privaten Räumen. Die Schalldämmplatten eignen sich besonders für die Kontrolle der frühen Reflexionen sowie der Nachhallzeit bei mittelhohen und hohen Frequenzen. Sie ermöglichen die Verringerung des Umgebungslärms in Büros, Versammlungsräumen, Callcentern, Videokonferenzräumen usw. Verfügbar in verschiedenen Größen, Farben und unterschiedlichen Anwendungsformen (Tischplatten, freistehende Trennwände sowie Wandplatten).

[FR] PANNEAUX ACOUSTIQUES

Gamme de panneaux acoustiques qui s'adaptent aux exigences techniques et esthétiques de chaque projet. Ils sont en polymère technique PET qui permet une excellente absorption acoustique aussi bien pour les espaces publics que privés. Les panneaux acoustiques sont particulièrement utiles pour le contrôle des premières réflexions, ainsi que du temps de réverbération avec des fréquences moyennes-hautes et hautes. Ils permettent de réduire le bruit de fond dans les bureaux, les salles de réunions, les centres d'appels, les salles de vidéoconférences, etc. Disponibles dans différentes mesures, couleurs et types d'application (table, séparateurs de pied et pour les cloisons)



[ESP] Como definir el número de paneles para cada necesidad?

La reverberación es un fenómeno sonoro producido por la reflexión, que consiste en una ligera permanencia del sonido una vez que la fuente original ha dejado de emitirlo.

Tiempo reverberación IDEAL en segundos para aulas / oficinas en función de los m² de la sala:

	10m ²	20m ²	30m ²	40m ²	50m ²
Aula / oficina	0.4	0.5	0.6	0.7	0.7

Metros cuadrados de paneles acústicos necesarios para conseguir los tiempos ideales comentados en la tabla anterior = (m² de la sala) x (Superficie a cubrir, en aulas/ oficina 60%)

Ejemplo: Oficina de 70m² x 0.60 (60% de superficie a cubrir) = 42m²

[ENG] How to define the number of panels for each need?

Reverberation is a sound phenomenon produced by reflection, which consists in a slight permanence of the sound once the original source has stopped emitting it. IDEAL reverberation time in seconds for classrooms / offices depending on the m² of the room

	10m ²	20m ²	30m ²	40m ²	50m ²
Office / Room	0.4	0.5	0.6	0.7	0.7

Meters panels of the acoustic panels needed to achieve the ideal times discussed in the table above = (m² of the room) x (Surface to cover, in classrooms / office 60%)

Example: Office of 70m² x 0.60 (60% of surface to cover) = 42m²

[DE] Wie kann die Anzahl der notwendigen Platten für den jeweiligen Anwendungsfall bestimmt werden?

Der Nachhall ist ein akustisches Phänomen, das durch Reflexion entsteht und sich dadurch auszeichnet, dass der Schall nach Verstummen der ursprünglichen Schallquelle kurz verbleibt und abklingt.

IDEALE Nachhallzeit in Sekunden für Hörsäle/Büroräume in Abhängigkeit der Raumgröße in m²:

	10m ²	20m ²	30m ²	40m ²	50m ²
Hörsaal / Büroraum	0.4	0.5	0.6	0.7	0.7

Erforderliche Quadratmeter Schalldämmplatten, um die in der vorherigen Tabelle erwähnten idealen Nachhallzeiten zu erhalten = (m² Raum) x (abzudeckende Oberfläche, in Hörsälen/Büroräumen 60 %)

Beispiel: Büro mit 70 m² x 0,60 (60 % der abzudeckenden Fläche) = 42 m²

[FR] Comment définir le nombre de panneaux pour chaque besoin ?

La réverbération est un phénomène sonore produit par la réflexion : le son reste pendant une court instant une fois que sa source d'origine a cessé d'émettre.

Temps de réverbération IDÉAL en secondes pour salles/bureaux en fonction de la superficie de la salle :

	10m ²	20m ²	30m ²	40m ²	50m ²
Salle / bureau	0.4	0.5	0.6	0.7	0.7

Superficie (en m²) de panneaux acoustiques nécessaires pour obtenir des temps idéaux indiqués dans le tableau ci-dessus = (Superficie en m² de la salle) x (60 % de la superficie à couvrir de salles/bureaux)

Exemple : Bureau de 70 m² x 0,60 (60 % de superficie à couvrir) = 42 m²

ACABADOS

FINISHES • DEKORE • FINITIONS



1
Gris / Grey
Grau / Gris

Limpieza: Con agua y jabón
Cleaning: With soap and water

Para medidas y aplicaciones especiales, consultar a Rocada.
For special sizes and uses contact Rocada.
Sonderanfertigungen auf Anfrage.
Veuillez contacter Rocada pour des dimensions et applications spécifiques.

- 3903-1
- 3904-1
- 3905-1
- 3906-1



3910-1



3920-1



3903-1

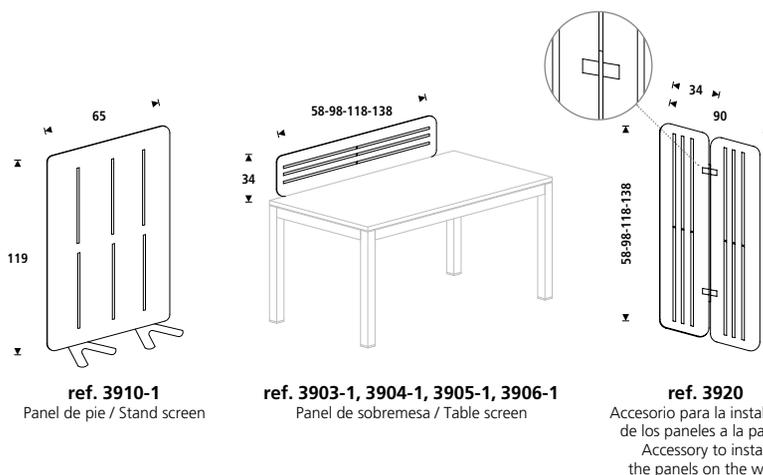

Ref.	cm (embalaje / packaging)	kg / m ³
3903-1* Panel/Screen 58x34cm	60x36x5	2 kg / 0,011 m ³
3904-1* Panel/Screen 98x34cm	100x36x5	2,5 kg / 0,018 m ³
3905-1* Panel/Screen 118x34cm	120x36x5	3 kg / 0,022 m ³
3906-1* Panel/Screen 138x34cm	140x36x5	3,5 kg / 0,025 m ³
3910-1 Panel de pie / Stand screen 119x65cm	121x67x8	12 kg / 0,065 m ³
3920 (2u) Accesorios para pared / Wall accessories	120x5x5	1 kg / 0,001 m ³

* Anclajes incluidos / Screen clamp included



STORE

[ESP] ESTRUCTURA METÁLICA

Estructura con sistema de regulación independiente (20mm) realizada en plancha de acero embutida y plegada, pintada en epoxy acabado según modelo. Admite baldas regulables metálicas para carpetas A4.

ESTRUCTURA MELAMINA

Estructura con sistema de regulación independiente (20 mm) de melamina de 25 y 19mm de grosor con canto de PVC de 2mm. Acabados en haya, aluminio, blanco y roble. Su mecanizado permite la fijación de diferentes configuraciones. Trasera DM de 3mm pintada por ambas caras en color gris.

CONFIGURACIONES

Puertas (vidrio o melamina en sus distintos 4 acabados) con sistema de cierre. Carpeteros (adaptables en todos los armarios de 90cm de ancho) con sistema de cierre y antivuelco. Estantes de melamina y metálicos (los metálicos permiten colgar carpetas A4). Sistema de unión de armarios con tapa superior doble.

Puertas de persiana para los armarios metálicos con sistema de cierre y totalmente ocultas.

Para medidas y aplicaciones especiales, consultar a Rocada.

[ENG] METAL STRUCTURE

Structure with independent adjustment system (20 mm) made from hammered and folded steel sheet, painted in epoxy. Suitable for metal adjustable shelves for A4 files.

MELAMINE STRUCTURE

25 and 19 mm melamine structure with independent height adjustment system (20 mm). Beech, aluminium, white and oak finishes. Its machining enables the attachment of different configurations.

Back panel of 3 mm MDF board, painted on both sides.

CONFIGURATIONS

Doors (glass or melamine in 4 different finishes) with locking system. File holders (adaptable in all 90 cm wide cupboards) with locking and anti-topple device. Melamine and metal shelves (A4 files can be hung in the metal shelves). Cupboard joining system with double upper cover.

Rolling doors for metal cupboards with locking system and completely hidden.

For special sizes and uses contact Rocada.

[DE] KORPUS AUS METALL

Korpus aus gefalteten, tiefgezogenen Stahlplatten mit Epoxidbeschichtung in verschiedenen Farben und zusätzlicher Höhennivellierung (20 mm). Verstellbare Einlegeböden für die Aufnahme von DIN A4-Mappen.

KORPUS AUS MELAMINBESCHICHTETEM HOLZ

Melaminbeschichtete Holzplatten (Stärke: 25 und 19 mm), 2 mm-Kunststoffkleimer. Höhennivellierung (20 mm). Korpusdekore: Buche, Eiche, Aluminium und Weiss. Fronten und Deckplatten wahlweise in Buche Eiche, Aluminium und Weiss. Schrankhöhen 78 cm (2OH) – 156 cm (3 OH) – 195 cm (5 OH), Schrankbreiten 90 und 45 cm. Metall-Sockelblende. Rückplatte aus MDF, beidseitig grau beschichtet (Stärke: 3mm).

KONFIGURATIONEN

Satinierte Glastüren mit Aluminiumrahmen oder melaminbeschichtete Holztüren in 4 verschiedenen Ausführungen, mit Verriegelung. Hängeregisterauszüge (für Schrankmodule mit 90 cm Breite) und Schubladen bei Rollcontainern mit Zentralverriegelung und Auszugssperre / Kippsicherung. Serienmäßig Einlegeböden aus melaminbeschichteter Spanplatte analog zum Schrankdekor. Optional sind für 90 cm breite Schrankelemente Metallböden erhältlich, die auch für die Aufnahme von DIN A4-Hängemappen geeignet sind. Verbindung von jeweils zwei Schrankelementen mittels doppelter Abdeckplatte optional möglich.

Für Metallschränke sind abschließbare Lamellentüren erhältlich.

Sonderabmessungen und Sonderanfertigungen auf Anfrage.

[FR] STRUCTURE MÉTALLIQUE

Structure avec système de réglage indépendant (20 mm) réalisée en acier perforé et plié, peinture époxy finitions. Compatible avec étagères en métal pour dossiers suspendus A4.

STRUCTURE MÉLAMINÉE

Structure avec système de réglage indépendant (20 mm) en mélaminé de 25 et 19 mm d'épaisseur avec chant en PVC de 2 mm. Finitions hêtre, aluminium, blanc et chêne. Son usinage permet d'adopter différentes configurations. Arrière DM de 3 mm peinte sur les deux faces.

CONFIGURATIONS

Portes (en verre ou en mélaminé selon les 4 finitions distinctes) avec système de fermeture. Classeurs (adaptables sur toutes les armoires de 90 cm de large) avec système de fermeture et dispositif anti-renversement. Étagères mélaminées et métalliques (la version métallique permet d'accrocher des dossiers suspendus). Système d'assemblage des armoires avec panneaux supérieurs double.

Portes persiennes pour armoires métalliques avec système de fermeture entièrement occultées.

Veillez contacter Rocada pour des dimensions et applications spécifiques.



ARMARIOS METÁLICOS DE PERSIANA

METAL BLIND CABINET • ROLLADEN-SCHRANCK • ARMOIRE À RIDEAUX

Para medidas y aplicaciones especiales, consultar a Rocada.
 For special sizes and uses contact Rocada.
 Sonderabmessungen und Sonderanfertigungen auf Anfrage.
 Veuillez contacter Rocada pour des dimensions et applications spécifiques.



[ESP] Armarios metálicos con niveladores realizados en plancha de acero. Puertas de persiana con cerradura realizadas en polímero técnico y baldas metálicas regulables en altura incluidas (admiten carpetas colgantes A4). Montados de serie.

[ENG] Metal cupboards with levelers made from steel sheet. Lockable rolling doors made from technical polymer and height adjustable metal shelves included (suitable for hanging A4 files). Series assembled.

[DE] Schränke aus Stahlplatten, mit Stellfüßen zur Höhenjustierung. Abschließbare Kunststoff – Lamellentüren. Höhenverstellbare Einlegeböden (auch für die Aufnahme von DIN A4-Hängemappen geeignet). Vormontierte Serienmodelle.

[FR] Armoires métalliques avec dispositifs de mise à niveau en acier. Portes persiennes avec fermeture en polymère technique et étagères métalliques réglables en hauteur incluses (pour recevoir des dossiers suspendus format A4). Montées en série.

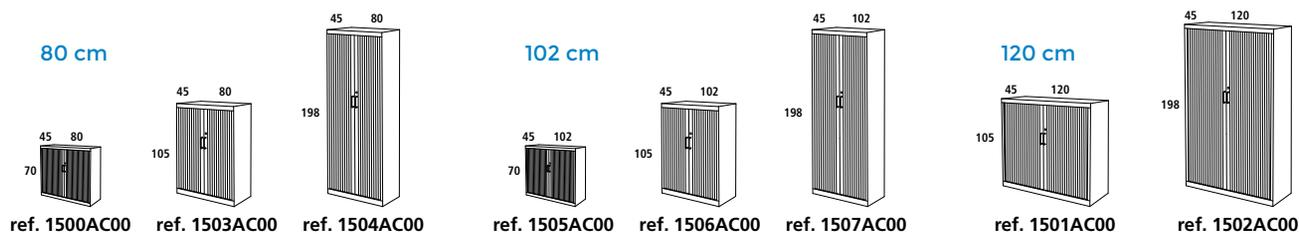

	Ref.	cm (producto / product)	kg / m ³ (embalaje / packaging)	baldas / shelves	Nº Packs
80 cm	1500AC00	70x80x45	25 kg / 0,250 m ³	1	1
	1503AC00	105x80x45	35 kg / 0,378 m ³	2	1
	1504AC00	198x80x45	58 kg / 0,712 m ³	4	1
102 cm	1505AC00	70x102x45	28 kg / 0,32 m ³	1	1
	1506AC00	105x102x45	36 kg / 0,48 m ³	2	1
	1507AC00	198x102x45	58 kg / 0,91 m ³	4	1
120 cm	1501AC00	105x120x45	38 kg / 0,570 m ³	2	1
	1502AC00	198x120x45	62 kg / 1,070 m ³	4	1

*Baldas incluidas / Shelves included.



1512AC
 Accesorio carpetas colgantes.
 Para armarios de ancho 120cm
 Hanging file folders accessory.
 Only for cupboard 120cm width

1504AC00



- 1 Cerradura con dos llaves plegables.
Locking system with 2 keys
- 2 Nivelador.
Leveler.

- 3 Baldas regulables en altura y que permiten carpetas colgantes.
Height adjustable metal shelves and suitable for hanging A4 files.



ACCESORIO CARPETAS COLGANTES

HANGING FILE FOLDERS • ZUBEHÖR HÄNGEORDNER
 ACCESSOIRE DOSSIERS SUSPENDUS



Para armarios de ancho 120cm
 Only for cupboard 120cm width

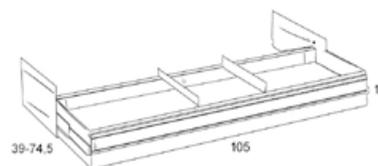

Ref.	cm (producto / product)	kg / m ³ (embalaje / packaging)	Nº Packs
1512AC (opcional / optional)	105x39x10	3 kg / 0,050 m ³	1





- 1 Cerradura con dos llaves plegables.
Locking system with 2 keys
- 2 Nivelador.
Leveler.
- 3 Baldas regulables en altura y que permiten carpetas colgantes.
Height adjustable metal shelves and suitable for hanging A4 files.

BALDA METÁLICA

METAL SHELF • EINLEGEBODEN METALL • ETAGÈRE EN MÉTAL

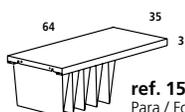

ref. 1510AC00
Para / For 1500AC00 - 1503AC00 - 1504AC00

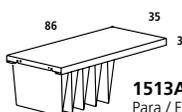

1513AC00
Para / For 1505AC00 - 1506AC00 - 1507AC00

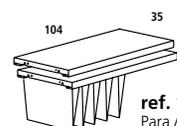

ref. 1511AC00
Para / For 1501AC00 - 1502AC00

Ref.	armario / cupboard	cm (producto / product)	kg / m ³ (embalaje / packaging)	Nº Packs
1510AC00 (1u.) opcional / optional	80 cm	64x35x3	3 kg / 0,099 m ³	1
1513AC00 (1u.) opcional / optional	102 cm	86x35x3	4 kg / 0,124 m ³	1
1511AC00 (2u.) opcional / optional	120 cm	104x35x3	7,75 kg / 0,142 m ³	1

ACABADOS

FINISHES • DEKORE • FINITIONS

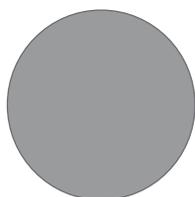

AC 00
RAL 9006
Gris / Grey

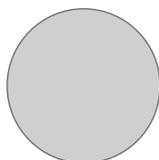

AC 10*
RAL 7035
Gris / Grey



AC 11*
RAL 7015
Antracita / Anthracite



AC 12*
RAL 9005
Negro / Black

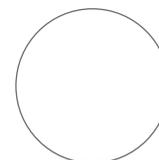

AC 13*
RAL 9010
Blanco / White

* Bajo pedido / On request

ARMARIOS METÁLICOS CON PUERTAS BATIENTES

TWO DOORS METAL CABINET • METALLSCHRANK • ARMOIRE PORTES BATTANTES

Para medidas y aplicaciones especiales, consultar a Rocada.
 For special sizes and uses contact Rocada.
 Sonderabmessungen und Sonderanfertigungen auf Anfrage.
 Veuillez contacter Rocada pour des dimensions et applications spécifiques.

1601AC00
2 Baldas / Shelves



1600AC00
1 Balda / Shelf

1602AC00
4 Baldas / Shelves



[ESP] Armarios metálicos con niveladores realizados en plancha de acero. Puertas metálicas de acero de 0.7 mm batientes con refuerzo interior y cerradura de seguridad con tirador incorporado. Baldas metálicas regulables en altura incluidas (admiten carpetas colgantes A4).

[ENG] Metal cupboards made of sheet steel, with levelling feet. Casement-opening 0.7 mm steel doors with interior reinforcement and security closure with built-in handle. Adjustable-height metal shelves (admit A4 hanging folders). Shelves included.

[DE] Solider Metall-Schrank aus Stahlblech mit Innenverstärkung. Stellfüße mit Höhenausgleich. Sicherheitsverriegelung mit eingelassenem Griff. Höhenverstellbare Einlegeböden aus Metall. Je nach Schrankhöhe gehören 1 - 3 Böden zum Lieferumfang.

[FR] Armoires métalliques avec niveleurs en tôle d'acier. Portes métalliques battantes en acier de 0,7 mm avec renfort intérieur et serrure de sécurité avec pommeau intégré. Étagères métalliques réglables en hauteur (admettant dossiers suspendus A4). Étagères incluses.

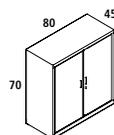

ref. 1600AC00

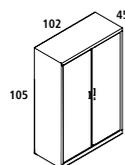

ref. 1601AC00

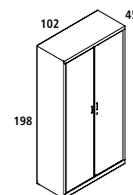

ref. 1602AC00

Ref.	cm (producto / product)	kg / m ³ (embalaje / packaging)	Nº Packs
1600AC00	70x80x45	31 kg / 0,250 m ³	1
1601AC00	105x102x45	48,9 kg / 0,480 m ³	1
1602AC00	198x102x45	80,9 kg / 0,910 m ³	1

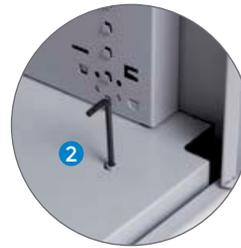

- 1 Cerradura con dos llaves plegables.
Locking system with 2 keys
- 2 Nivelador.
Leveler.

- 3 Baldas regulables en altura y que permiten carpetas colgantes.
Height adjustable metal shelves and suitable for hanging A4 files.

BALDA METÁLICA

METAL SHELF • EINLEGEBODEN METALL • ETAGÈRE EN MÉTAL

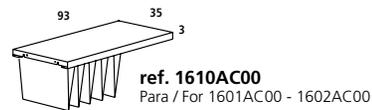

Ref.	armario / cupboard	cm (producto / product)	kg / m ³ (embalaje / packaging)	Nº Packs
1611AC00 (1u) opcional / optional.	80 cm	71x35x3	3 kg / 0,007 m ³	1
1610AC00 (1u.) opcional / optional	102 cm	93x35x3	4 kg / 0,009 m ³	1

ACABADOS

FINISHES • DEKORE • FINITIONS

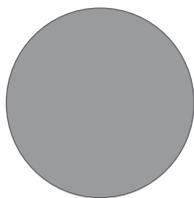

AC 00
RAL 9006
Gris / Grey

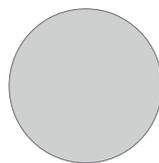

AC 10*
RAL 7035
Gris / Grey



AC 11*
RAL 7015
Antracita / Anthracite



AC 12*
RAL 9005
Negro / Black

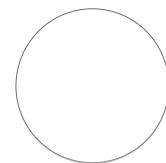

AC 13*
RAL 9010
Blanco / White

* Bajo pedido / On request

ARCHIVADORES METÁLICOS

STEEL FILING CABINET • HÄNGEREGISTRATURSCHRÄNKE • CLASSEURS MÉTALLIQUES



Para medidas y aplicaciones especiales, consultar a Rocada.
 For special sizes and uses contact Rocada.
 Sonderabmessungen und Sonderanfertigungen auf Anfrage.
 Veuillez contacter Rocada pour des dimensions et applications spécifiques.

[ESP] Archivadores metálicos para carpetas colgantes. Realizados en plancha de acero entre 0.6 y 0.8mm de espesor. Estructura soldada. Cajones con guías metálicas y rodamientos de alta resistencia de extracción total, con sistema de cierre centralizado y antivuelco. Barra móvil que permite archivar tamaño A4 y folio. Cumplen normativa BS4875 apartado 7. Se suministran montados. Garantía 5 años.

[ENG] Steel filing cabinet for hanging A4 files. Manufactured in 0.6mm and 0.8mm steel. Fully welded structure. Drawer with a metallic runners, locking draws and anti-topple device. The drawers are adjustable to fit Fulscape and A4 size. Tested to BS4875. Comes assembled. 5 year warranty.

[DE] Einreihig, wahlweise mit 2, 3 oder 4 Schüben. Korpus aus 0,6 / 0,8mm starkem Stahlblech. Metallschübe mit Auszugssperre / Antikippicherung und Zentralverschluss. Montierte Anlieferung. 5 Jahre Garantie.

[FR] Classeurs métalliques pour dossiers suspendus format A4. En tôle acier de 0,6 et 0,8 mm d'épaisseur. Structure soudée. Tiroirs avec guides métalliques et système antivol centralisé. Les tiroirs sont réglables pour recevoir des documents aux formats Ministre ou A4. Satisfont à la norme BS4875.7. Livrés montés. Garantie 5 ans.

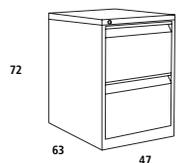

ref. 1650AC00

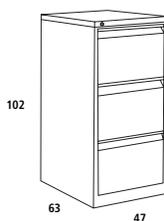

ref. 1651AC00

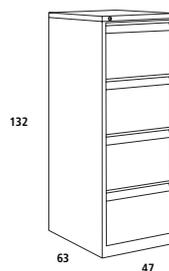

ref. 1652AC00

Ref.	cm (producto / product)	kg / m³ (embalaje / packaging)	Nº Packs
1650AC00	47,5x62,7x71,6	28 Kg / 0,213 m³	1
1651AC00	47,5x62,7x102,1	38 Kg / 0,304 m³	1
1652AC00	47,5x62,7x132,6	50 Kg / 0,394 m³	1



- 1 Cerradura con dos llaves plegables.
Locking system with 2 keys.
- 2 Sistema antivuelco incorporado para una máxima seguridad.
Anti-topple device to get the maximum safety.
- 3 Portaetiquetas
Label support
- 4 Barra móvil que permite archivar tamaño A4 y folio.
The drawers are adjustable to fit Fulscap and A4 size.
- 5 Cajones metálicos realizados en chapa de acero.
Metallic drawer made in steel sheet.



ACABADOS

FINISHES • DEKORE • FINITIONS

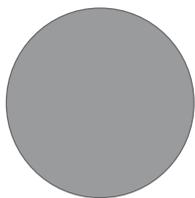

AC 00
RAL 9006
Gris / Grey

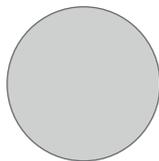

AC 10*
RAL 7035
Gris / Grey



AC 11*
RAL 7015
Antracita / Anthracite



AC 12*
RAL 9005
Negro / Black

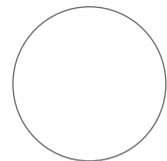

AC 13*
RAL 9010
Blanco / White

* Bajo pedido / On request

ARMARIOS DE MELAMINA

MELAMINE CUPBOARDS • MELAMIN SCHRÄNKE • ARMOIRES DE MÉLAMINE



1 Estructura realizada en melamina de 19-25mm. Structure made in melamine of 19-25mm thickness.

2 Armarios con zócalo metálico. Cupboards with metallic plinth.

3 Cerradura con 2 llaves plegables. Locking system with 2 keys.

4 Baldas regulables de melamina de 25mm de espesor. Adjustable melamine shelves of 25mm thickness.

5 Tiradores metálicos con acabado metalizado. Metallic Handel with metallic finish.

6 Trasera color gris. Backside in grey.



ARMARIOS DE MELAMINA

MELAMINE CUPBOARDS • MELAMIN SCHRÄNKE • ARMOIRES DE MÉLAMINE



1 Estructura realizada en melamina de 19-25mm.
Structure made in melamine of 19-25mm thickness.

4 Baldas regulables de melamina de 25mm de espesor.
Adjustable melamine shelves of 25mm thickness.

2 Armarios con zócalo metálico.
Cupboards with metallic plinth.

5 Tiradores metálicos con acabado metalizado.
Metallic Handel with metallic finish.

3 Cerradura con 2 llaves plegables.
Locking system with 2 keys.

6 Trasera color gris
Backside in grey



ARMARIOS CON TAPA

CUPBOARDS WITH TOP PANEL • SCHRÄNKE MIT ABSCHLUSSPLATTE
ARMOIRES AVEC PANNEAUX

195 cm

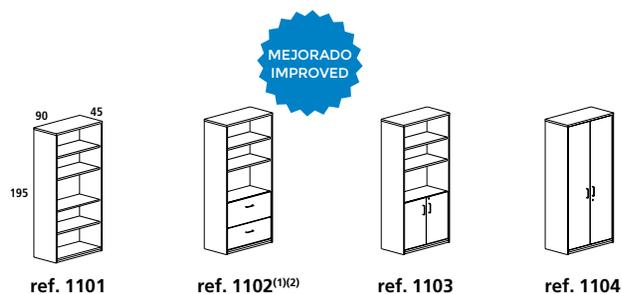

Altura / Height / Höhe / Hauteur 195 cm			
Ref.	cm (producto / product)	kg / m ³ (embalaje / packaging)	Nº Packs
1101	195x90x45	64,50 kg / 0,125 m ³	3
1102 ⁽¹⁾⁽²⁾	195x90x45	88,25 kg / 0,176 m ³	4
1103	195x90x45	73,20 kg / 0,145 m ³	4
1104	195x90x45	86,65 kg / 0,169 m ³	4

⁽¹⁾Armarios carpetero admiten todo tipo de carpetas gracias a su estructura regulable / Filing cupboards which allow the use of any type of files thanks it's adjustable structure

⁽²⁾Montaje bajo pedido / Assembling under request

Armarios con zócalo metálico y todas las baldas de 25mm incluidas / Cupboards with metallic plinth and all 25mm shelves included

156 cm

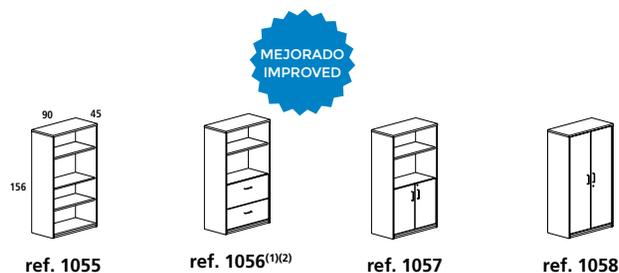

Altura / Height / Höhe / Hauteur 156 cm			
Ref.	cm (producto / product)	kg / m ³ (embalaje / packaging)	Nº Packs
1055	156x90x45	53,80 kg / 0,115 m ³	3
1056 ⁽¹⁾⁽²⁾	156x90x45	71 kg / 0,201 m ³	4
1057	156x90x45	62,50 kg / 0,135 m ³	4
1058	156x90x45	71,49 kg / 0,180 m ³	4

⁽¹⁾Armarios carpetero admiten todo tipo de carpetas gracias a su estructura regulable / Filing cupboards which allow the use of any type of files thanks it's adjustable structure

⁽²⁾Montaje bajo pedido / Assembling under request

Armarios con zócalo metálico y todas las baldas de 25mm incluidas / Cupboards with metallic plinth and all 25mm shelves included

78 cm



Altura / Height / Höhe / Hauteur 78 cm			
Ref.	cm (producto / product)	kg / m ³ (embalaje / packaging)	Nº Packs
1004	78x90x45	30,25 kg / 0,051 m ³	2
1006 ⁽¹⁾⁽²⁾	78x90x45	47,45 kg / 0,152 m ³	3
1005	78x90x45	38,95 kg / 0,086 m ³	3

⁽¹⁾Armarios carpetero admiten todo tipo de carpetas gracias a su estructura regulable / Filing cupboards which allow the use of any type of files thanks it's adjustable structure

⁽²⁾Montaje bajo pedido / Assembling under request

Armarios con zócalo metálico y todas las baldas de 25mm incluidas / Cupboards with metallic plinth and all 25mm shelves included

ARMARIOS SIN TAPA

CUPBOARDS WITHOUT TOP PANEL
SCHRÄNKE OHNE ABSCHLUSSPLATTE
ARMOIRES SANS PANNEAUX

156 cm

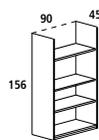

ref. 1051

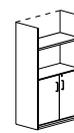
ref. 1052⁽¹⁾⁽²⁾

ref. 1053

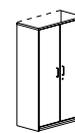

ref. 1054

Altura / Height / Höhe / Hauteur 156 cm

Ref.	cm (producto / product)	kg / m ³ (embalaje / packaging)	Nº Packs
1051*	156x90x45	47,3 kg / 0,100 m ³	2
1052 ⁽¹⁾⁽²⁾	156x90x45	64,50 kg / 0,186 m ³	3
1053*	156x90x45	56 kg / 0,120 m ³	3
1054*	156x90x45	64,95 kg / 0,135 m ³	3

*Armarios para tapa corrida ref 1903 para dos armarios / Cupboards with slide runners ref 1903 for two cupboards

⁽¹⁾Armarios carpetero admiten todo tipo de carpetas gracias a su estructura regulable / Filing cupboards which allow the use of any type of files thanks it's adjustable structure

⁽²⁾Montaje bajo pedido / Assembling under request

Armarios con zócalo metálico y todas las baldas de 25mm incluidas / Cupboards with metallic plinth and all 25mm shelves included

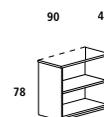

ref. 1001*

ref. 1002⁽¹⁾⁽²⁾

ref. 1003*

78 cm

Altura / Height / Höhe / Hauteur 78 cm

Ref.	cm (producto / product)	kg / m ³ (embalaje / packaging)	Nº Packs
1001*	78x90x45	23,75 kg / 0,051 m ³	1
1002 ⁽¹⁾⁽²⁾	78x90x45	40,95 kg / 0,135 m ³	2
1003*	78x90x45	32,45 kg / 0,071 m ³	2

*Armarios para tapa corrida ref 1903 para dos armarios / Cupboards with slide runners ref 1903 for two cupboards

⁽¹⁾Armarios carpetero admiten todo tipo de carpetas gracias a su estructura regulable / Filing cupboards which allow the use of any type of files thanks it's adjustable structure

Armarios con zócalo metálico y todas las baldas de 25mm incluidas / Cupboards with metallic plinth and all 25mm shelves included

⁽²⁾ Montaje bajo pedido / Assembling under request

TAPA SUPERIOR

TOP PANEL • ABSCHLUSSPLATTE • DESSUS D'ARMOIRE

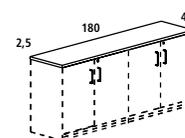

ref. 1903

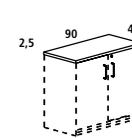

ref. 1904

Ref.	cm (producto / product)	kg / m ³ (embalaje / packaging)	Nº Packs
1903	180x45x2,5	14 kg / 0,035 m ³	1
1904	90x45x2,5	6,5 kg / 0,015 m ³	1

ARMARIOS COLUMNA

COLUMN-TYPE CUPBOARDS / SCHRÄNKE IN SÄULENFORM / ARMOIRE COLONNE

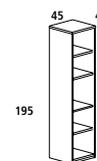

ref. 1105



ref. 1007

Ref.	cm (producto / product)	kg / m ³ (embalaje / packaging)	Nº Packs
Altura / Height / Höhe / Hauteur 195 cm			
1105	195x45x45	44 kg / 0,087 m ³	3
Altura / Height / Höhe / Hauteur 78 cm			
1007	78x45x45	19,40 kg / 0,040 m ³	2

Armarios con zócalo metálico y todas las baldas de 25mm incluidas / Cupboards with metallic plinth and all 25mm shelves included

ACABADOS

FINISHES • DEKORE • FINITIONS

ARMARIOS CON TAPA • CUPBOARDS WITH TOP PANEL
SCHRÄNKE MIT ABSCHLUSSPLATTE • ARMOIRES AVEC PANNEAUX



AA 01
Haya / Haya
Beech / Beech
Buche / Buche
Hêtre / Hêtre



AA 02
Haya / Gris
Beech / Grey
Buche / Grau
Hêtre / Gris



AA 04
Haya / Blanco
Beech / White
Buche / Weiss
Hêtre / Blanc



AA 08
Haya / Roble
Beech / Oak
Buche / Eiche
Hêtre / Chêne



AB 01
Aluminio / Haya
Aluminium / Beech
Aluminium / Buche
Aluminium / Hêtre



AB 02
Aluminio / Gris
Aluminium / Grey
Aluminium / Grau
Aluminium / Gris



AB 04
Aluminio / Blanco
Aluminium / White
Aluminium / Weiss
Aluminium / Blanc



AB 08
Aluminio / Roble
Aluminium / Oak
Aluminium / Eiche
Aluminium / Chêne



AW 01
Blanco / Haya
White / Beech
Weiss / Buche
Blanc / Hêtre



AW 02
Blanco / Gris
White / Grey
Weiss / Grau
Blanc / Gris



AW 04
Blanco / Blanco
White / White
Weiss / Weiss
Blanc / Blanc



AW 08
Blanco / Roble
White / Oak
Weiss / Eiche
Blanc / Chêne



AR 01
Roble / Haya
Oak / Beech
Eiche / Buche
Chêne / Hêtre



AR 02
Roble / Gris
Oak / Grey
Eiche / Grau
Chêne / Gris



AR 04
Roble / Blanco
Oak / White
Eiche / Weiss
Chêne / Blanc



AR 08
Roble / Roble
Oak / Oak
Eiche / Eiche
Chêne / Chêne



1057. AW08

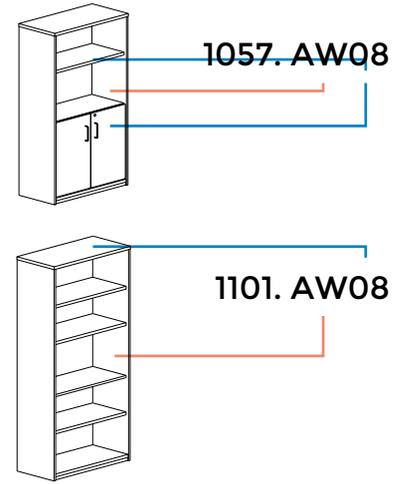

ARMARIOS SIN TAPA / CUPBOARDS WITHOUT TOP PANEL
SCHRÄNKE OHNE ABSCHLUSSPLATTE / ARMOIRES SANS PANNEAUX

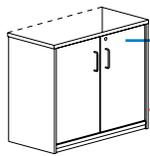

1003. AW08

+

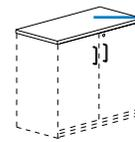

190408

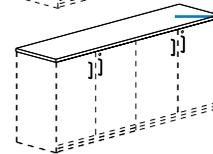

190308

ACABADOS TAPA SUPERIOR / TOP PANEL FINISHES / DEKORE ABSCHLUSSPLATTEN / FINITIONS DESSUS D'ARMOIRE



01
Haya · Beech
Buche · Hêtre



02
Gris · Grey
Grau · Gris

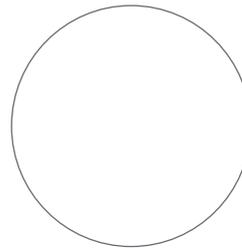

04
Blanco · White
Weiss · Blanc



08
Roble · Oak
Eiche · Chêne

PERCHERO PARA ARMARIO DE MELAMINA

COAT RACK FOR MELAMINE CUPBOARD • HANGING ACCESSORY FÜR MELAMINE SCHRANK
FERMETURE POUR ARMOIRE EN MÉLAMINE



Medidas / Sizes (cm)

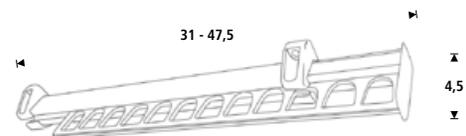

Ref.	cm (producto / product)	kg / m ³ (embalaje / packaging)
1910	32x5x4	0,5 kg / 0,001 m ³

ARMARIOS CON PUERTAS DE CRISTAL SIN TAPA

CUPBOARDS WITH GLASS DOORS WITHOUT TOP PANEL

+SCHRÄNKE MIT GLASTÜREN, OHNE ABSCHLUSSPLATTE

ARMOIRES AVEC PORTES VITRÉES SANS PANNEAUX SUPÉRIEURS

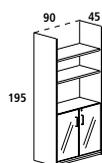

ref. 1111

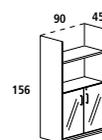

ref. 1053

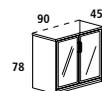

ref. 1003

Ref.	cm (producto / product)	kg / m ³ (embalaje / packaging)	Nº Packs
Altura / Height / Höhe / Hauteur 195 cm			
1111	195x90x45	66,7 kg / 0,120 m ³	3
Altura / Height / Höhe / Hauteur 156 cm			
1053	156x90x45	56 kg / 0,101 m ³	3
Altura / Height / Höhe / Hauteur 78 cm			
1003	78x90x45	32,45 kg / 0,071 m ³	2

Armarios con zócalo metálico y todas las baldas de 25mm incluidas / Cupboards with metallic plinth and all 25mm shelves included

ACABADOS

FINISHES • DEKORE • FINITIONS



AA 05 (+190401)
Haya / Haya · Beech / Beech
Buche / Buche · Hêtre / Hêtre



AA 05 (+190402)
Haya / Gris · Beech / Grey
Buche / Grau · Hêtre / Gris



AA 05 (+190404)
Haya / Blanco · Beech / White
Buche / Weiss · Hêtre / Blanc



AA 05 (+190408)
Haya / Roble · Beech / Oak
Buche / Eiche · Hêtre / Chêne



AB 05 (+190401)
Aluminio / Haya · Aluminium / Beech
Aluminium / Buche · Aluminium / Hêtre



AB 05 (+190402)
Aluminio / Gris · Aluminium / Grey
Aluminium / Grau · Aluminium / Gris



AB 05 (+190404)
Aluminio / Blanco · Aluminium / White
Aluminium / Weiss · Aluminium / Blanc



AB 05 (+190408)
Aluminio / Roble · Aluminium / Oak
Aluminium / Eiche · Aluminium / Chêne



AW 05 (+190401)
Blanco / Haya · White / Beech
Weiss / Buche · Blanc / Hêtre



AW 05 (+190402)
Blanco / Gris · White / Grey
Weiss / Grau · Blanc / Gris



AW 05 (+190404)
Blanco / Blanco · White / White
Weiss / Weiss · Blanc / Blanc



AW 05 (+190408)
Blanco / Roble · White / Oak
Weiss / Eiche · Blanc / Chêne



AR 05 (+190401)
Roble / Haya · Oak / Beech
Eiche / Buche · Chêne / Hêtre



AR 05 (+190402)
Roble / Gris · Oak / Grey
Eiche / Grau · Chêne / Gris



AR 05 (+190404)
Roble / Blanco · Oak / White
Eiche / Weiss · Chêne / Blanc



AR 05 (+190408)
Roble / Roble · Oak / Oak
Eiche / Eiche · Chêne / Chêne



1057. **AW05(+190408)**

Ref 1904 (TAPA SUPERIOR / TOP PANEL /
ABSCHLUSSPLATTEN / DESSUS D'ARMOIRE)
pag. siguiente / next page

ACABADOS

FINISHES • DEKORE • FINITIONS

ARMARIOS SIN TAPA • CUPBOARDS WITHOUT TOP PANEL
SCHRÄNKE OHNE ABSCHLUSSPLATTE • ARMOIRES SANS PANNEAUX

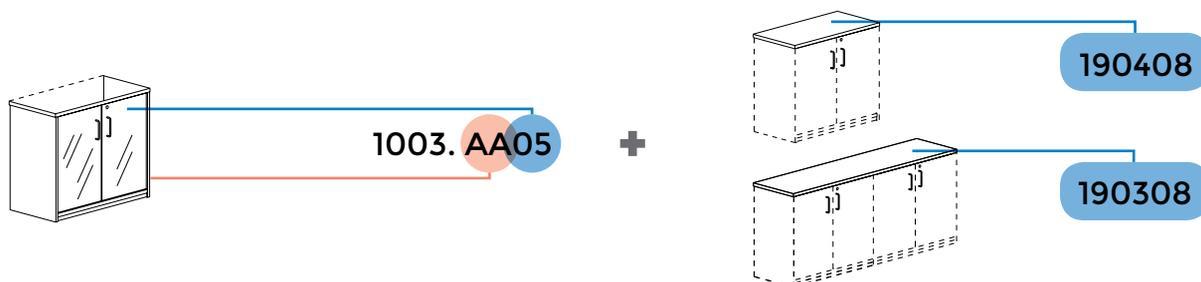

ACABADOS TAPA SUPERIOR / FINISHES TOP PANEL / DEKORE ABSCHLUSSPLATTEN / FINITIONS DESSUS D'ARMOIRE



01
Haya
Beech
Buche
Hêtre



02
Gris
Grey
Grau
Gris

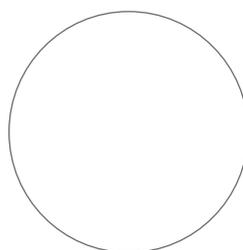

04
Blanco
White
Weiss
Blanc



08
Roble
Oak
Eiche
Chêne

ACCESORIOS

ACCESSORIES • ZUBEHÖR • ACCESSOIRES

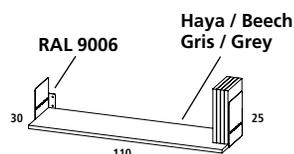

ref. 11-042

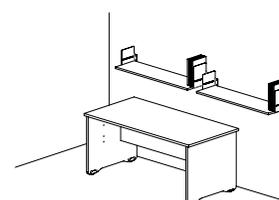

ESTANTERÍA DE PARED / SHELF / FACHBÖTEN / ETAGÈRES

Ref.	cm (producto / product)	kg / m ³ (embalaje / packaging)	Nº Packs
11-042 Gris / Grey	110x30x26	5,6 kg / 0,086 m ³	1
11-042/1 Haya / Beech	110x30x26	5,6 kg / 0,086 m ³	1

Estantería de melamina y laterales metálicos / Melamine shelf with metallic sides.

ACCESORIOS

ACCESSORIES • ZUBEHÖR • ACCESSOIRES

1905AB00 gris • grey



1905AR00 roble • oak

1905AA00 haya • beech

1905AW00 blanco • white

Balda para armarios de melamina
Shelf for melamine cupboards.

1906AC00 gris • grey

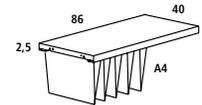

ref. 1906AC00 gris/grey

BALDA METÁLICA • METAL SHELVES • EINLEGEBODEN METALL • ETAGÈRES EN MÉTAL

Ref.	cm (producto / product)	kg / m ³ (embalaje / packaging)	N° Packs
1906AC00	86x40	3,1 kg / 0,010 m ³	1

BALDA DE MELAMINA • MELAMINE SHELVES • EINLEGEBODEN MELAMINE • ETAGÈRES EN MÉLAMINÉL



ref. 1905AA / 1905 AB / 1905AW / 1905AR

Ref.	cm (producto / product)	kg / m ³ (embalaje / packaging)	N° Packs
1905AA00	86x40	3,1 kg / 0,010 m ³	1
1905AB00	86x40	3,1 kg / 0,010 m ³	1
1905AW00	86x40	3,1 kg / 0,010 m ³	1
1905AR00	86x40	3,1 kg / 0,010 m ³	1

BALDAS METÁLICAS • METALIC SHELVES

80 carpetas A4 por leja /
80 folders A4 for shelve

ref. 1906 (1 u)

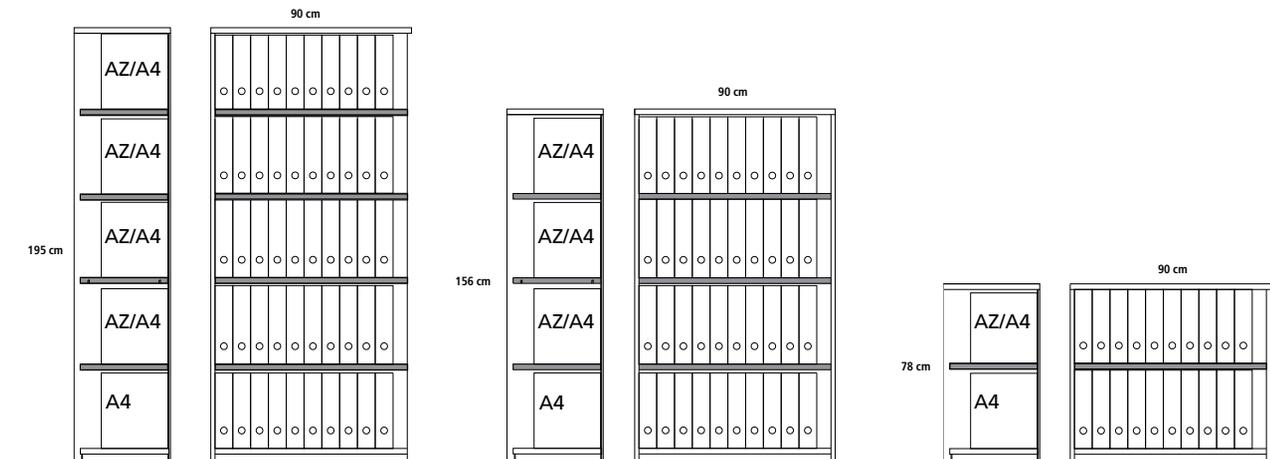
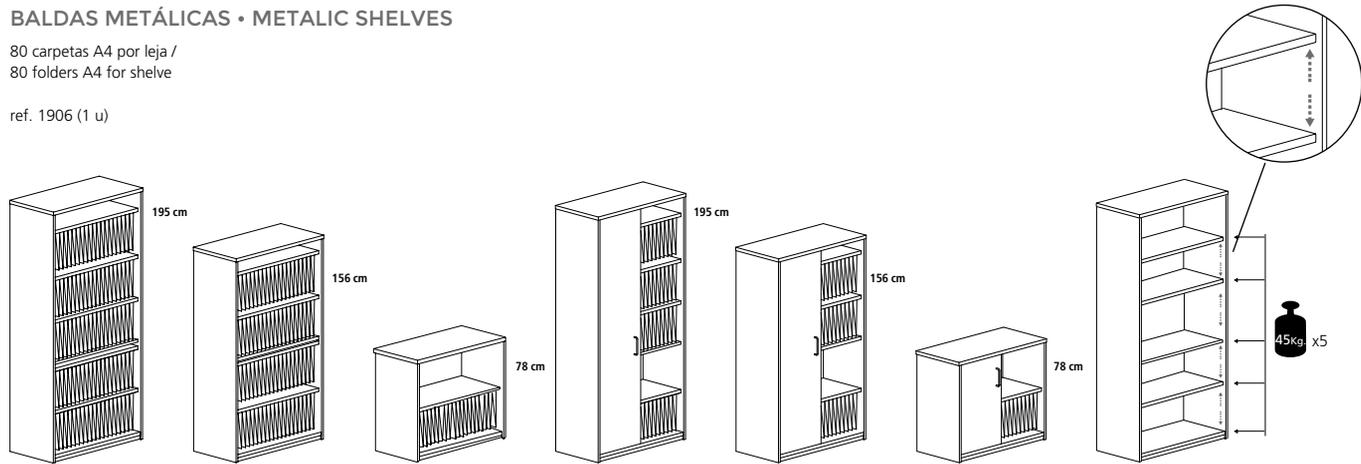

BUCKS CON GUÍAS METÁLICAS, CERRADURA CENTRALIZADA Y ANTIVUELCO

PEDESTAL WITH METALLIC RUNNERS, LOCKING SYSTEM AND ANTI-TOPPLE DEVICE
 CONTAINER MIT METALLSCHUBLADEN, ZENTRALVERRIEGELUNG UND AUSZUGSSPERRE
 SYSTÈME DE VERROVILLAGE ET DISPOSITIF ANTI-BASCULEMENT

Cajoneras de melamina • Melamine pedestal



1 Estructura realizada en melamina de 19mm en su totalidad, incluido trasera. Structure made in melamine of 19mm thickness, even the back side.

2 Las 4 ruedas disponen de sistema de freno para la correcta fijación. Wheels with brake system to get the best fixation.

3 Cerradura con 2 llaves plegables. Locking system with 2 keys.

4 Sistema de cierre centralizado para la confidencialidad deseada. Locking system to get the maximum confidentiality.

5 Sistema antivuelco incorporado para una máxima seguridad. Anti-topple device to get the maximum safety.

6 Tiradores metálicos con acabado metalizado. Metallic Handel with metallic finish.

7 Cajones metálicos realizados en chapa de acero. Metallic drawer made in steel sheet.

8 Guías metálicas con rodamientos de Nylon. Metallic runners with Nylon wheels.



ref. 4003



ref. 4004

Ref.	cm (embalaje / packaging)	kg / m ³ (embalaje / packaging)	Nº Packs
4003	64x53x42	25,10 kg / 0,138 m ³	1
4004	64x53x42	25,25 kg / 0,138 m ³	1

ACABADOS

FINISHES • DEKORE • FINITIONS

BUCKS MÓVILES • MOBILE PEDESTAL • ROLLCONTAINER • BLOC TIROIRS MOBILE



AA 01
Haya / Haya · Beech / Beech
Buche / Buche · Hêtre / Hêtre



AA 02
Haya / Gris · Beech / Grey
Buche / Grau · Hêtre / Gris



AA 04
Haya / Blanco · Beech / White
Buche / Weiss · Hêtre / Blanc



AA 08
Haya / Roble · Beech / Oak
Buche / Eiche · Hêtre / Chêne



AB 01
Aluminio / Haya · Aluminium / Beech
Aluminium / Buche · Aluminium / Hêtre



AB 02
Aluminio / Gris · Aluminium / Grey
Aluminium / Grau · Aluminium / Gris



AB 04
Aluminio / Blanco · Aluminium / White
Aluminium / Weiss · Aluminium / Blanc



AB 08
Aluminio / Roble · Aluminium / Oak
Aluminium / Eiche · Aluminium / Chêne



AW 01
Blanco / Haya · White / Beech
Weiss / Buche · Blanc / Hêtre



AW 02
Blanco / Gris · White / Grey
Weiss / Grau · Blanc / Gris



AW 04
Blanco / Blanco · White / White
Weiss / Weiss · Blanc / Blanc



AW 08
Blanco / Roble · White / Oak
Weiss / Eiche · Blanc / Chêne



AR 01
Roble / Haya · Oak / Beech
Eiche / Buche · Chêne / Hêtre



AR 02
Roble / Gris · Oak / Grey
Eiche / Grau · Chêne / Gris



AR 04
Roble / Blanco · Oak / White
Eiche / Weiss · Chêne / Blanc



AR 08
Roble / Roble · Oak / Oak
Eiche / Eiche · Chêne / Chêne



4003.AA02

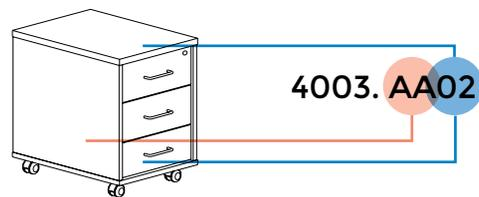

4003.AA02

BUCKS CON GUÍAS METÁLICAS, CERRADURA CENTRALIZADA Y ANTIVUELCO

PEDESTAL WITH METALLIC RUNNERS, LOCKING SYSTEM AND ANTI-TOPPLE DEVICE
CONTAINER MIT METALLSCHUBLADEN, ZENTRALVERRIEGLUNG UND AUSZUGSSPERRE
SYSTÈME DE VERROVILLAGE ET DISPOSITIF ANTI-BASCULEMENT

Cajoneras metálicas • Metallic pedestal





- 1 Cerradura con 2 llaves.
Locking system with 2 keys.
- 2 Sistema antivuelco incorporado para una máxima seguridad.
Anti-topple device to get the maximum safety.
- 3 Las ruedas disponen de sistema de freno para la correcta fijación.
Wheels with brake system to get the best fixation.
- 4 Cajones metálicos realizados en chapa de acero.
Metallic drawer made in steel sheet.
- 5 Sistema de cierre centralizado para la confidencialidad deseada.
Locking system to get the maximum confidentiality.
- 6 Guías metálicas con rodamientos de Nylon.
Metallic runners with Nylon wheels.

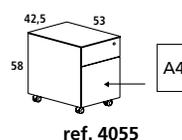

ref. 4055

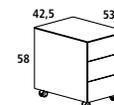

ref. 4054

Ref.	cm (embalaje / packaging)	kg / m ³ (embalaje / packaging)	Nº Packs
4054	59x56x48	20 kg / 0,155 m ³	1
4055*	59x56x48	20 kg / 0,155 m ³	1

ACABADOS

FINISHES • DEKORE • FINITIONS

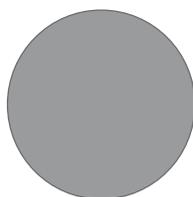

AC 00
RAL 9006
Gris / Grey

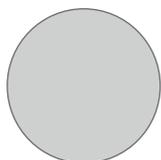

AC 10*
RAL 7035
Gris / Grey



AC 11*
RAL 7015
Antracita / Anthracite



AC 12*
RAL 9005
Negro / Black

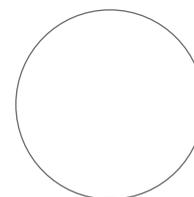

AC 13
RAL 9010
Blanco / White

* Bajo pedido / On request

BUCKS CON GUÍAS METÁLICAS, CERRADURA CENTRALIZADA Y ANTIVUELCO

PEDESTAL WITH METALLIC RUNNERS, LOCKING SYSTEM AND ANTI-TOPPLE DEVICE
CONTAINER MIT METALLSCHUBLADEN, ZENTRALVERRIEGELUNG UND AUSZUGSSPERRE
SYSTÈME DE VERROVILLAGE ET DISPOSITIF ANTI-BASCULEMENT

Cajoneras de melamina • Melamine pedestal



- 1 Estructura realizada en melamina de 19mm en su totalidad, incluido trasera. Structure made in melamine of 19mm thickness, even the back side.
- 2 Cerradura con 2 llaves plegables. Locking system with 2 keys.
- 3 Sistema de cierre centralizado para la confidencialidad deseada. Locking system to get the maximum confidentiality.
- 4 Sistema antivuelco incorporado para una máxima seguridad. Anti-topple device to get the maximum safety.
- 5 Tiradores metálicos con acabado metalizado. Metallic Handel with metallic finish.
- 6 Guías metálicas con rodamientos de Nylon. Metallic runners with Nylon wheels.

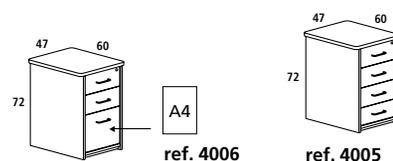

Ref.	cm (embalaje / packaging)	kg / m ³ (embalaje / packaging)	Nº Packs
4005	74x62x51	35,10 kg / 0,192 m ³	1
4006	74x62x51	35,25 kg / 0,192 m ³	1

ACABADOS

FINISHES • DEKORE • FINITIONS

BUCKS FIJOS / STILL PEDESTAL / CONTAINER / BLOC TIROIRS



AA 01
Haya / Haya · Beech / Beech
Buche / Buche · Hêtre / Hêtre



AA 02
Haya / Gris · Beech / Grey
Buche / Grau · Hêtre / Gris



AA 04
Haya / Blanco · Beech / White
Buche / Weiss · Hêtre / Blanc



AA 08
Haya / Roble · Beech / Oak
Buche / Eiche · Hêtre / Chêne



AB 01
Aluminio / Haya · Aluminium / Beech
Aluminium / Buche · Aluminium / Hêtre



AB 02
Aluminio / Gris · Aluminium / Grey
Aluminium / Grau · Aluminium / Gris



AB 04
Aluminio / Blanco · Aluminium / White
Aluminium / Weiss · Aluminium / Blanc



AB 08
Aluminio / Roble · Aluminium / Oak
Aluminium / Eiche · Aluminium / Chêne



AW 01
Blanco / Haya · White / Beech
Weiss / Buche · Blanc / Hêtre



AW 02
Blanco / Gris · White / Grey
Weiss / Grau · Blanc / Gris



AW 04
Blanco / Blanco · White / White
Weiss / Weiss · Blanc / Blanc



AW 08
Blanco / Roble · White / Oak
Weiss / Eiche · Blanc / Chêne



AR 01
Roble / Haya · Oak / Beech
Eiche / Buche · Chêne / Hêtre



AR 02
Roble / Gris · Oak / Grey
Eiche / Grau · Chêne / Gris



AR 04
Roble / Blanco · Oak / White
Eiche / Weiss · Chêne / Blanc



AR 08
Roble / Roble · Oak / Oak
Eiche / Eiche · Chêne / Chêne

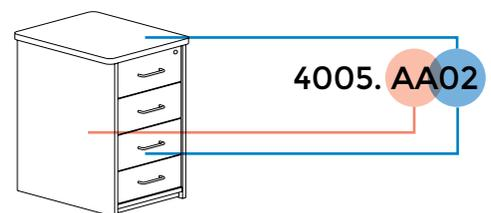

WELCOME

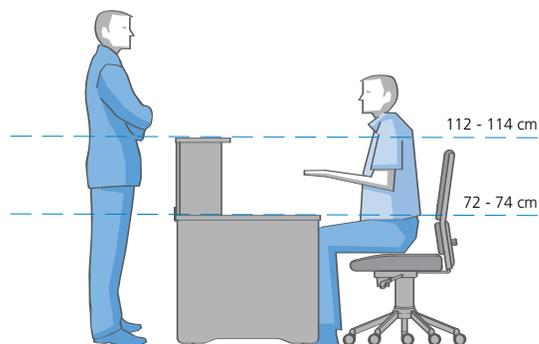

[ESP] SUPERFICIES DE MESA

Melamínico sobre aglomerado de 19-25 mm de grosor con canto de PVC de 2 mm. Acabados en haya, gris, roble y blanco. Superficies con cantos rectos.

COMPLEMENTOS

Soporte CPU metálico, separador, sistema de electrificación vertical y horizontal.

Para medidas y aplicaciones especiales, consultar a Rocada.

[ENG] TABLE TOPS

19-25 mm melamine coated particle board with 2 mm PVC edges. Beech, grey, oak and white finishes. Table tops with straight edges.

ACCESSORIES

Metal CPU support, divider, horizontal and vertical cable management system.

For special sizes and uses contact Rocada.

[DE] TISCH- / ABSCHLUSSPLATTE

Melaminbeschichtete Spanplatte 19-25mm, mit 2 mm Kunststoffumleimer. Serienmäßig Dekorvarianten Buche hell und Lichtgrau.

ZUBEHÖR

Horizontale und vertikale Kabelführungen. CPU Träger.

Sonderanfertigungen auf Anfrage.

[FR] PLATEAUX DE TABLE

Panneau de particules mélaminé de 19-25 mm d'épaisseur avec chant en PVC de 2 mm. Finitions hêtre, gris, chêne et blanc. Plateaux avec chants droits

ACCESSOIRES

Support Unité centrale, séparateur, système électrique vertical et horizontal.

Veillez contacter Rocada pour des dimensions et applications spécifiques.

WELCOME















MÓDULO SUPERIOR

UPPER MODULE • TOP-MODUL • MODULE TOP



5016 + Metal table



5016 + Work table



5016 + Executive table

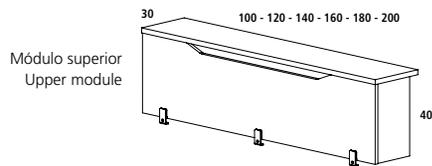
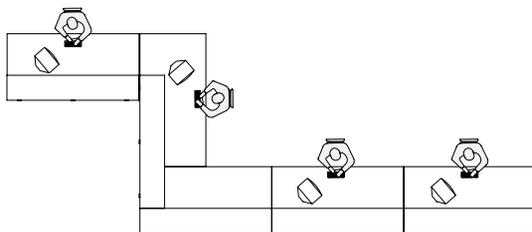

Módulo superior
Upper module

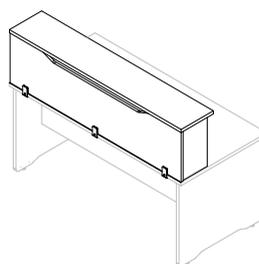
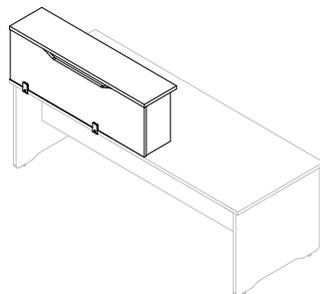

Recepción total o parcial
Total or partial reception

Ref.	cm (producto /product)	kg / m ³ (embalaje / packaging)	Acabados / Finishes Dekore / Finitons
5010	100x30x40	11 kg / 0,027 m ³	
5012	120x30x40	14 kg / 0,031 m ³	
5014	140x30x40	17 kg / 0,035 m ³	
5016	160x30x40	21 kg / 0,040 m ³	
5018	180x30x40	24 kg / 0,044 m ³	
5020	200x30x40	27 kg / 0,048 m ³	

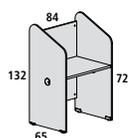

ref. 5501

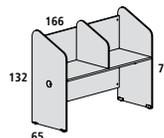

ref. 5502

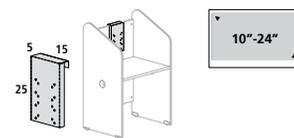

RD-2027

Accesorio TV / TV accessory

CALL CENTER

Ref.	cm (producto / product)	kg / m ³ (embalaje / packaging)	N° Packs
5501	84x132x65	40,8 kg / 0,115 m ³	2
5502	166x132x65	66,8 kg / 0,236 m ³	2
RD-2027 Accesorio TV / TV accessory	22,5x8x27	1 kg / 0,005 m ³	1

ACABADOS

FINISHES • DEKORE • FINITIONS

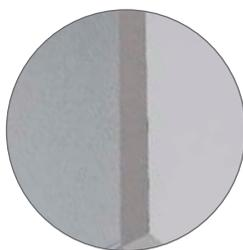

AB 02
Aluminio / Gris
Aluminium / Grey
Alu / Grau
Aluminium / Gris

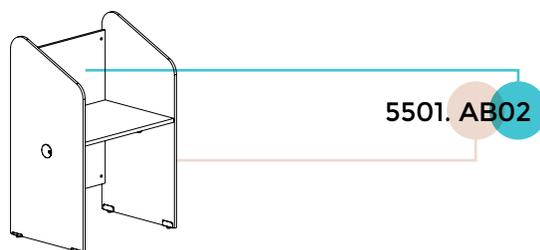

5100AA01

Módulo circular realizado en melamina y acero. Su diseño permite todo tipo de aplicaciones como recepción en eventos, catering, atril de conferencia, soporte para video proyecciones... Disponible con ruedas o con niveladores de polímero de alta resistencia. Ruedas de serie. Fácil montaje.

Circular module made of melamine and steel. Its design allows all types of uses such as events reception, catering, conference lectern, video projection support. Includes castors.

Universal - Thekenmodul. Das innovative, mobile, modular erweiterbare Empfangsmöbel im attraktiven Materialmix aus Holz und Metall. Basismodul mit 90° Radius, verkettbar oder mit Zusatzmodulen als Einzel-Präsentationsmöbel verwendbar. Serienausführung mit stabilen, einzeln feststellbaren Laufrollen. Optional auch mit Stellfüßen verwendbar. Bestens geeignet als Empfangstheke, Infotresen, Messemöbel, Aktionstresen, Cateringtheke, Rednerpult, Beamerpult... Arbeitsplatte und Trägerkonstruktion melaminbeschichtet, 19mm stark, Dekor Buche hell. Frontplatte aus 0,8 mm Lochblech, Graualuminium pulverbeschichtet.

Module circulaire en mélaminé et acier. Sa conception permet tous types d'agencement : réception sur événements, catering, pupitre de conférence, support pour vidéo-projections, etc. Disponible sur roulettes ou avec dispositif de mise à niveau en polymère haute résistance. Montage facile.



ref. 5100AA01

ref. 5100V01

Accesorio para video proyecciones realizado en melamina y acero. Regulable en altura 250mm. Fácil montaje.

Melamine and steel video projection accessory. Height adjustable, 250 mm. Easy to assemble.

Beameraufsatz für Video-Projektoren. Höhenjustierung bis zu 250 mm.

Accessoire pour vidéo projecteurs réalisé en mélaminé et acier. Réglable en hauteur 250 mm. Montage facile.

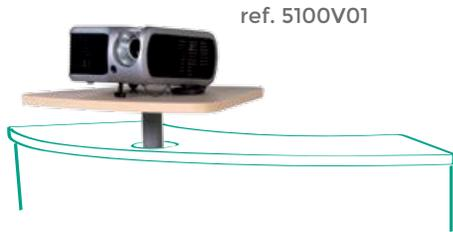

ref. 5100V01

ref. 5100S

Accesorio para conferencias realizado en acero. Regulable en altura 250mm. Fácil montaje.

Steel conference accessory. Height adjustable, 250 mm. Easy to assemble.

Manuskriptaufsatz. Höhenjustierung bis zu 250 mm.

Accessoires de conférence en acier. Réglable en hauteur 250 mm. Montage facile.

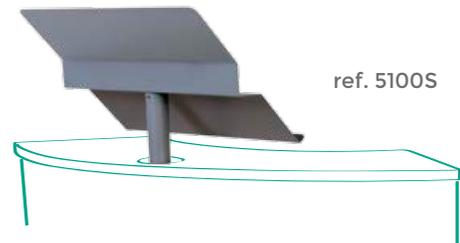

ref. 5100S



ref. 5100AA01

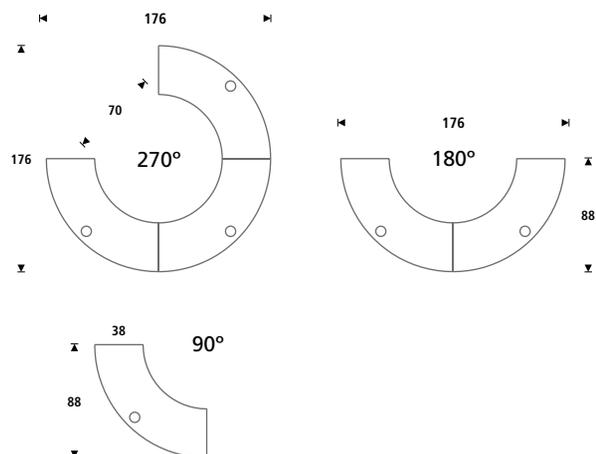



MÓDULO CIRCULAR

CIRCULAR MODULE • RUNDMODUL • MODULE CIRCULAIRE

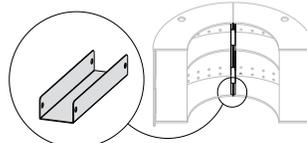
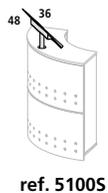
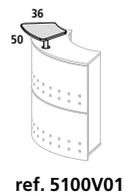
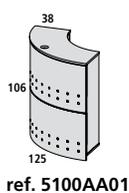

Niveladores opcionales
Optional levelers

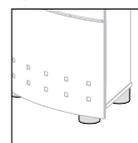

Ref.	cm (producto /product)	kg / m ³ (embalaje / packag- ing)	Nº Packs	Acabados / Finishes Dekore / Finitons
5100AA01	145x58x13	36 kg / 0,109 m ³	1	Haya / Beech / Buche / Hêtre
5100V01	48x40x11	4 kg / 0,021 m ³	1	Haya / Beech / Buche / Hêtre
5100S	48x40x11	4 kg / 0,021 m ³	1	Gris / Grey / Grau / Gris
5100J (2u.)	11x6,5x25	1 kg / 0,001 m ³	1	Gris / Grey / Grau / Gris
5100T (5u.)	11x6,5x25	1 kg / 0,001 m ³	1	Negro / Black / Schwartz / Noir

MEETING

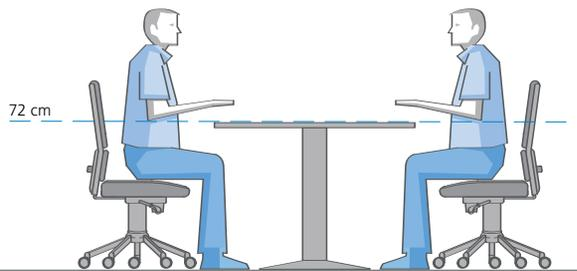

[ESP] ESTRUCTURA

Estructura metálica realizada en tubo de acero de diámetro 120mm y 50mm según modelos con base de acero estampado de gran estabilidad.

ESTRUCTURA MELAMINA

Estructura melamínica con sistema de regulación independiente (20 mm). Melamínico sobre aglomerado de 25 mm de grosor con canto de PVC de 2 mm de grosor. Acabados en haya, aluminio, blanco y roble. Estructura con cantos redondeados.

Para medidas y aplicaciones especiales, consultar a Rocada.

[ENG] STRUCTURE

Metal structure made of 120 mm and 50 mm diameter steel tubing depending on the model with a stamped steel base of great stability.

MELAMINE STRUCTURE

Melamine structure with independent adjustment system (20 mm). Melamine coated 25 mm particle board with 2 mm PVC edges. Beech, aluminium and white finishes. Structure with rounded edges.

For special sizes and uses contact Rocada.

[DE] GESTELL

Stabile Säulengestelle aus Stahlrohr, je nach Modell mit 120 mm oder 50mm Ø und Tellerfüßen aus gestanztem Stahl, wahlweise verchromt oder graualuminium pulverbeschichtet. Tischplatten aus melaminbeschichteter Spanplatte (25mm) oder satiniertem, gehärtetem Glas (10mm) Alternativ bei einigen Modellen Wangenkonstruktionen aus melaminbeschichteter Spanplatte sowie Konferenztischkombinationen auf Basis der Serien luxe und executive.

WANGENGESTELL

Melaminbeschichtete Spanplatte (Stärke: 25 mm). mit 2 mm Kunststoff - Umleimer Farbvarianten: Buche hell oder Aluminium. Abgerundete Kanten.
Tischhöhe: 720 mm mit zusätzlich 20 mm Höhennivellierung.

Sonderabmessungen und Sonderanfertigungen auf Anfrage.

[FR] STRUCTURE

Structure métallique en tube d'acier de diamètre 120 mm et 50 mm en fonction des modèles sur base en acier estampé très stable.

STRUCTURE MÉLAMINÉ

Structure mélaminée avec système de réglage indépendant (20 mm). Panneau de particules mélaminé de 25 mm d'épaisseur avec chant en PVC de 2 mm d'épaisseur. Finitions hêtre, aluminium et blanc. Structure avec chants arrondis.

Veillez contacter Rocada pour des dimensions et applications spécifiques.









MEETING
FRIDAY 11:30

BREAKFAST 7:10

CALL TO 34 3 584 56 35









COFFEE TABLE

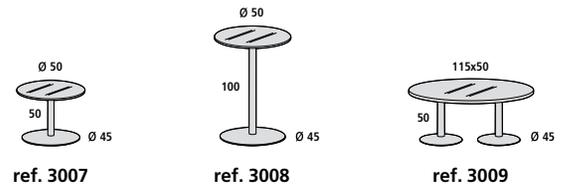

Ref.	N° Packs	cm (producto / product).	kg / m ³ (embalaje / packaging)	Estructura pintada Painted structure		Estructura cromada Chromed structure		Estructura melamina -	
				Melamine	Cristal	Melamina	Cristal	Melamina	Cristal
3007	2	Ø50x50	10 kg / 0,028 m ³	✓	-	-	✓	-	-
3008	2	Ø50x100	12 kg / 0,032 m ³	✓	-	-	✓	-	-
3009	3	115x50	18 kg / 0,052 m ³	-	-	-	✓	-	-

MESA REUNIÓN CIRCULAR

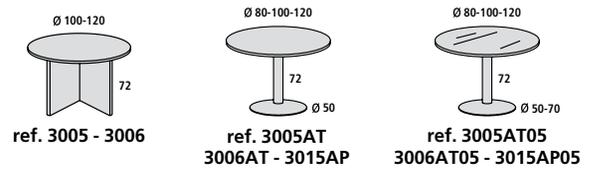

CIRCULAR MEETING TABLE • BESPRECHUNGSTISCH • BUREAU DE RÉUNION RONDE

Ref.	N° Packs	cm (producto / product).	kg / m ³ (embalaje / packaging)	Estructura pintada Painted structure		Estructura cromada Chromed structure		Estructura melamina Melamine structure	
				Melamine	Cristal	Melamina	Cristal	Melamina	Cristal
3015AP	2	Ø80	26,6 kg / 0,112 m ³	-	-	✓	✓	-	-
3005	2	Ø100	31,6 kg / 0,078 m ³	-	-	-	-	✓	-
3005AT	2	Ø100	26,6 kg / 0,111 m ³	✓	✓	-	-	-	-
3006	2	Ø120	38,1 kg / 0,091 m ³	-	-	-	-	✓	-
3006AT	2	Ø120	31,7 kg / 0,127 m ³	✓	✓	-	-	-	-

3015AP disponible en melamina acabado haya (01) y gris (02)
3015AP available in beech (01) and grey (02) melamine finishes

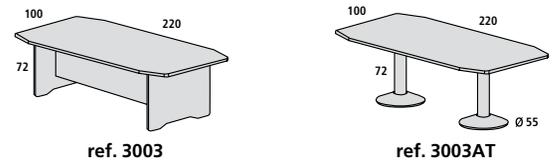

MESA REUNIÓN

MEETING TABLE • KONFERENZTISCH • BUREAU DE RÉUNION

Ref.	N° Packs	cm (producto / product).	kg / m ³ (embalaje / packaging)	Estructura pintada Painted structure		Estructura cromada Chromed structure		Estructura melamina Melamine structure	
				Melamine	Cristal	Melamina	Cristal	Melamina	Cristal
3003	2	220x100x72	56,8 kg / 0,176 m ³	-	-	-	-	✓	-
3003AT	3	220x100x72	64,6 kg / 0,282 m ³	✓	-	-	-	-	-

ACABADOS

FINISHES • DEKORE • FINITIONS

PIE COLUMNA • COLUMN BASE • SÄULENGESTELL • PIED COLONNE

**AT 01**

Aluminio / Haya
Aluminium / Beech
Aluminium / Buche
Aluminium / Hêtre

**AT 02**

Aluminio / Gris
Aluminium / Grey
Aluminium / Grau
Aluminium / Gris

**AT 04**

Aluminio / Blanco
Aluminium / White
Aluminium / Weiss
Aluminium / Blanc

**AT 05⁽¹⁾**

Aluminio / Cristal translúcido
Aluminium / Translucent glass
Aluminium / Satinierte glas
Aluminium / Translucide verre

**AT 08**

Aluminio / Roble
Aluminium / Oak
Aluminium / Eiche
Aluminium / Chêne

**ATW 01**

Blanco / Haya
White / Beech
Weiss / Buche
Blanc / Hêtre

**ATW 02**

Blanco / Gris
White / Grey
Weiss / Grau
Blanc / Gris

**ATW 04**

Blanco / Blanco
White / White
Weiss / Weiss
Blanc / Blanc

**ATW 05⁽¹⁾**

Blanco / Cristal translúcido
White / Translucent glass
Weiss / Satinierte glas
Blanc / Translucide verre

**ATW 08**

Blanco / Roble
White / Oak
Weiss / Eiche
Blanc / Chêne

**ATY 01**

Antracita / Haya
Anthracite / Beech
Anthrazit / Buche
Anthracite / Hêtre

**ATY 02**

Antracita / Gris
Anthracite / Grey
Anthrazit / Grau
Anthracite / Gris

**ATY 04**

Antracita / Blanco
Anthracite / White
Anthrazit / Weiss
Anthracite / Blanc

**ATY 05⁽¹⁾**

Antracita / Cristal translúcido
Anthracite / Translucent glass
Anthrazit / Satinierte glas
Anthracite / Translucide verre

**ATY 08**

Antracita / Roble
Anthracite / Oak
Anthrazit / Eiche
Anthracite / Chêne

**AP 01⁽³⁾**

Cromado / Haya
Chrome / Beech
Chrom / Buche
Chrome / Hêtre

**AP 02⁽³⁾**

Cromado / Gris
Chrome / Grey
Chrom / Grau
Chrome / Gris

**AP 05⁽²⁾⁽³⁾**

Cromado / Cristal translúcido
Chrome / Translucent glass
Chrom / Satinierte glas
Chrome / Translucide verre



(1) ref 3003 - 3007 - 3008 - 3009 no disponible / not available.

(2) Solo para modelos 3007 - 3008 - 3009 / Only for 3007 - 3008 - 3009 models.

(3) Acabados / finishes 3015AP

ACABADOS

FINISHES • DEKORE • FINITIONS

PIE MELAMINA • MELAMINE FOOT • MELAMIN FUSS • PIED MÉLAMINÉ



AA 01
Haya / Haya · Beech / Beech
Buche / Buche · Hêtre / Hêtre



AA 02
Haya / Gris · Beech / Grey
Buche / Grau · Hêtre / Gris



AA 04
Haya / Blanco · Beech / White
Buche / Weiss · Hêtre / Blanc



AA 08
Haya / Roble · Beech / Oak
Buche / Eiche · Hêtre / Chêne



AB 01
Aluminio / Haya · Aluminium / Beech
Aluminium / Buche · Aluminium / Hêtre



AB 02
Aluminio / Gris · Aluminium / Grey
Aluminium / Grau · Aluminium / Gris



AB 04
Aluminio / Blanco · Aluminium / White
Aluminium / Weiss · Aluminium / Blanc



AB 08
Aluminio / Roble · Aluminium / Oak
Aluminium / Eiche · Aluminium / Chêne



AW 01
Blanco / Haya · White / Beech
Weiss / Buche · Blanc / Hêtre



AW 02
Blanco / Gris · White / Grey
Weiss / Grau · Blanc / Gris



AW 04
Blanco / Blanco · White / White
Weiss / Weiss · Blanc / Blanc



AW 08
Blanco / Roble · White / Oak
Weiss / Eiche · Blanc / Chêne



AR 01
Roble / Haya · Oak / Beech
Fiche / Buche · Chêne / Hêtre



AR 02
Roble / Gris · Oak / Grey
Fiche / Grau · Chêne / Gris



AR 04
Roble / Blanco · Oak / White
Fiche / Weiss · Chêne / Blanc



AR 08
Roble / Roble · Oak / Oak
Fiche / Eiche · Chêne / Chêne



3005. AA01



3003. AB01



ref BLANCA / pag 6



ref TOTAL / pag 22



ref EXECUTIVE / pag 38

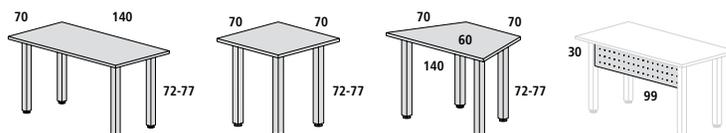

ref. RD-7502N

ref. RD-7510N

ref. RD-7520N

ref. RD-7507N

MESAS MODULARES

MODULAR TABLES • BEISTELLTISCHE • TABLES MODULABLES

Ref.	cm (producto / product).	kg / m ³ (embalaje / packaging)	Nº Packs
RD-7502N	140x70x72	28,3 kg / 0,086 m ³	2
RD-7510N	70x70x72	19,7 kg / 0,067 m ³	2
RD-7520N	140x60x72	27 kg / 0,086 m ³	2
RD-7507N	99x30	5 kg / 0,015 m ³	1



RD 7510N	RD 7502N	RD 7520N				
70x70cm	140x70cm	140x60cm	120x140cm	260x140cm	400x140cm	240x280cm
		310x280cm	380x280cm	347x120cm	280x140cm	205x178cm
		280x280cm	380x135cm	312x250cm		

MESA PLEGABLE

FOLDING TABLE • KLAPPTISCH • TABLE PLIABLE

Tablero gris
Grey top table



Para medidas y aplicaciones especiales, consultar a Rocada.
For special sizes and uses contact Rocada.
Sonderabmessungen und Sonderanfertigungen auf Anfrage.
Veuillez contacter Rocada pour des dimensions et applications spécifiques.

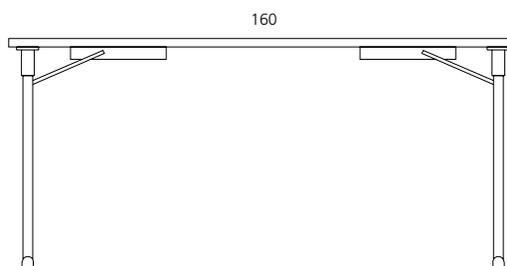
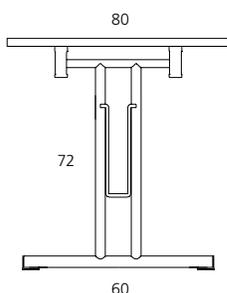

[ESP] Mesa con tablero de melamina 25mm estructura en acero cromado plegable para solucionar todo tipo de necesidades. Ideal para salas polivalentes en las que se realizan todo tipo de actividades. Fácil montaje.

[ENG] Rectangular folding table for easy storage and handling with 25mm scratch resistance melamine tops, 2mm PVC, Impact resistant edging (the same as the other melamine tables) , helps protect against daily use: the legs have a plastic part that avoid the contact between the structure and the floor in horizontal position when the table is folded

[DE] Die flexible und platzsparende Einrichtungslösung, damit Konferenz- und Workshop-Räume variabel nutzbar bleiben. Rechteckiger Klapp Tisch, der senkrecht stehend gelagert werden kann. Die 25mm starke Tischplatte ist mit einer unempfindlichen und langlebigen Melaminbeschichtung versehen. Kunststoffumleimer 2mm. Das Fußgestell ist zum Schutz des Fußbodenbelags mit Kunststoffgleitern ausgestattet.

[FR] Table avec plateau en mélaminé de 25 mm. Structure pliable en acier chromé permettant un stockage et une manutention faciles. Idéal pour utilisation en salles polyvalentes. Montage facile.

Ref.	cm (producto / product).	kg / m ³ (embalaje / packaging)	Nº Packs
RD-7503N	160x80x72	30 Kg / 0,100 m ³	2

ROLL

[ESP] CORTINAS ENROLLABLES

Gama de cortinas enrollables que permiten personalizar los distintos ambientes de una oficina según las necesidades de trabajo.

Cortinas enrollables translúcidas de gran calidad, con núcleo de 43mm de aluminio, mecanismo reversible, cadena con opción de instalación a derecha o izquierda. Tejido realizado en poliéster 30% y PVC 70%. Su amplia gama de medidas, tejidos y acabados del mecanismo permiten una adaptación total a cualquier espacio.

[ENG] ROLLING CURTAINS

Range of roller blinds that allow to customize the different environments of an office according to the office needs.

High quality translucent roller blinds, with 43mm aluminium core with reversible mechanisms, the option to install the chain to the right or left. Fabric made of 30% polyester and 70% PVC. Its wide range of measures, fabrics and finishes of the mechanism allow a total adaptation to any space.

[DE] ROLLVORHÄNGE

Produktreihe mit Rollos, die je nach Arbeitsanforderung eine individuelle Gestaltung der verschiedenen Umgebungen eines Büros ermöglichen.

Lichtdurchlässige Rollos von hoher Qualität, mit einem 43 mm großen Aluminiumkern mit umkehrbarem Mechanismus sowie Zugkette mit rechts- oder linksseitiger Einbauoption. Gewebe aus 30 % Polyester und 70 % PVC. Das umfangreiche Angebot an verschiedenen Größen, Gewebearten und Ausführungen des Mechanismus ermöglichen die vollständige Anpassung an jeden Raum.

[FR] STORES ENROULEURS

Gamme de stores enrouleurs permettant de personnaliser différents environnements d'un bureau en fonction des besoins de travail.

Store enrouleur tamisant de grande qualité, avec un axe de 43 mm en aluminium équipé de mécanismes réversibles et d'une chaîne en option pouvant être installée à droite ou à gauche. Tissu en polyester 30% et PVC 70%. Vaste gamme de dimensions, tissus et finitions du mécanismes pour une adaptation parfaite à tout type d'espace.

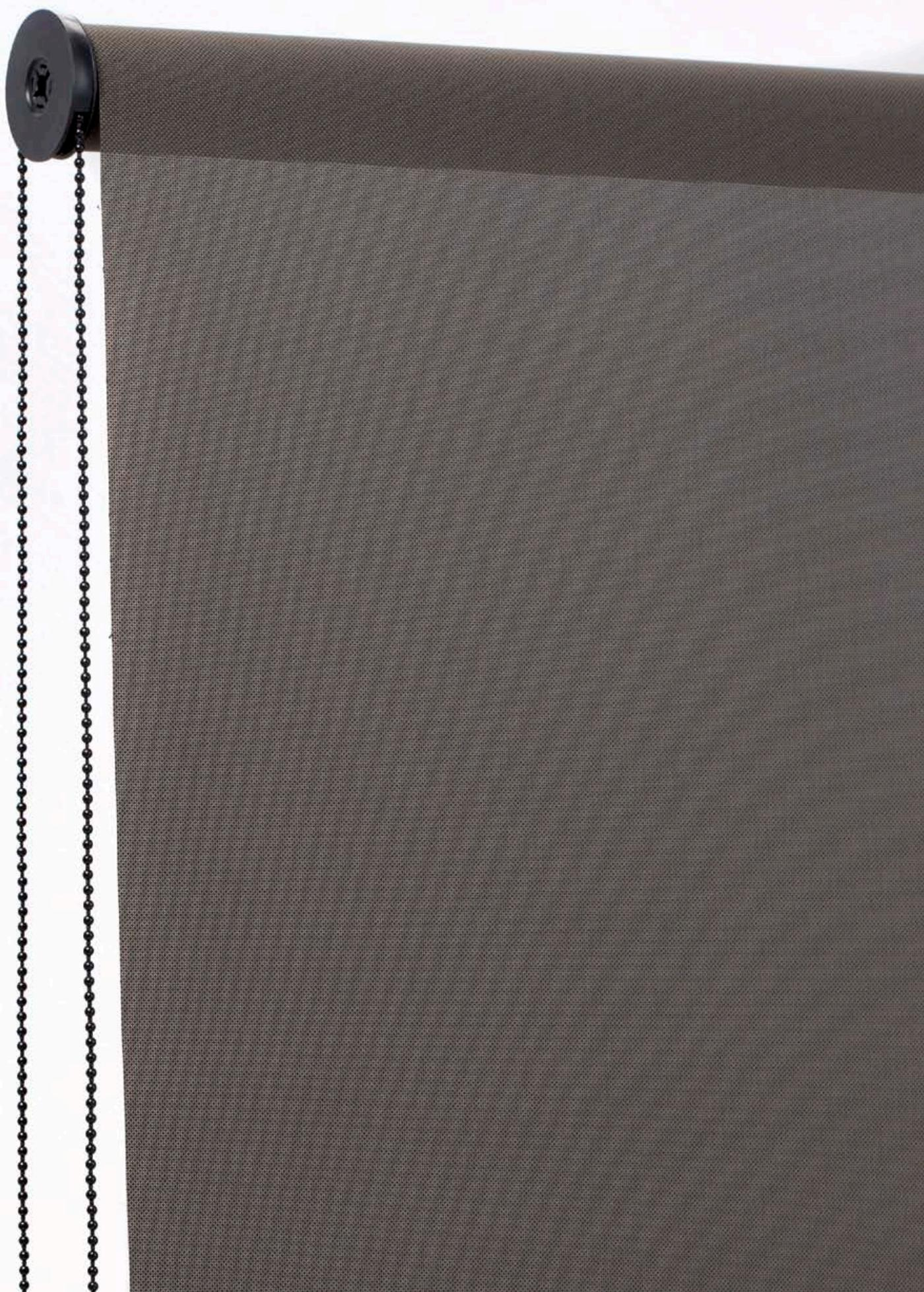



Características tejido:
 30% poliéster
 70% PVC
 Reacción al fuego según UNE-EN 13773 (Clase 1)

Fabric features:
 30% Polyestryene
 70% PVC
 Flame retardant UNE-EN 13773 (Class 1)

		Ancho / Width / Breite / Largeur						
		100	120	140	160	180	200	220
140	ROLL10-14	ROLL12-14	ROLL14-14	ROLL16-14	ROLL18-14	ROLL20-14	ROLL22-14	
	120x12x10	140x12x10	160x12x10	180x12x10	200x12x10	220x12x10	240x12x10	
	3 kg / 0,014 m ³	3 kg / 0,017 m ³	4 kg / 0,019 m ³	4 kg / 0,022 m ³	4 kg / 0,024 m ³	5kg / 0,026 m ³	5kg / 0,029 m ³	
160	ROLL10-16	ROLL12-16	ROLL14-16	ROLL16-16	ROLL18-16	ROLL20-16	ROLL22-16	
	120x12x10	140x12x10	160x12x10	180x12x10	200x12x10	220x12x10	240x12x10	
	3 kg / 0,014 m ³	3 kg / 0,017 m ³	4 kg / 0,019 m ³	4 kg / 0,022 m ³	4 kg / 0,024 m ³	5kg / 0,026 m ³	5kg / 0,029 m ³	
180	ROLL10-18	ROLL12-18	ROLL14-18	ROLL16-18	ROLL18-18	ROLL20-18	ROLL22-18	
	120x12x10	140x12x10	160x12x10	180x12x10	200x12x10	220x12x10	240x12x10	
	3 kg / 0,014 m ³	3 kg / 0,017 m ³	4 kg / 0,019 m ³	4 kg / 0,022 m ³	4 kg / 0,024 m ³	5kg / 0,026 m ³	5kg / 0,029 m ³	
200	ROLL10-20	ROLL12-20	ROLL14-20	ROLL16-20	ROLL18-20	ROLL20-20	ROLL22-20	
	120x12x10	140x12x10	160x12x10	180x12x10	200x12x10	220x12x10	240x12x10	
	3 kg / 0,014 m ³	3 kg / 0,017 m ³	4 kg / 0,019 m ³	4 kg / 0,022 m ³	4 kg / 0,024 m ³	5kg / 0,026 m ³	5kg / 0,029 m ³	
220	ROLL10-22	ROLL12-22	ROLL14-22	ROLL16-22	ROLL18-22	ROLL20-22	ROLL22-22	
	120x12x10	140x12x10	160x12x10	180x12x10	200x12x10	220x12x10	240x12x10	
	3 kg / 0,014 m ³	3 kg / 0,017 m ³	4 kg / 0,019 m ³	4 kg / 0,022 m ³	4 kg / 0,024 m ³	5kg / 0,026 m ³	5kg / 0,029 m ³	
240	ROLL10-24	ROLL12-24	ROLL14-24	ROLL16-24	ROLL18-24	ROLL20-24	ROLL22-24	
	120x12x10	140x12x10	160x12x10	180x12x10	200x12x10	220x12x10	240x12x10	
	3 kg / 0,014 m ³	3 kg / 0,017 m ³	4 kg / 0,019 m ³	4 kg / 0,022 m ³	4 kg / 0,024 m ³	5kg / 0,026 m ³	5kg / 0,029 m ³	
260	ROLL10-26	ROLL12-26	ROLL14-26	ROLL16-26	ROLL18-26	ROLL20-26	ROLL22-26	
	120x12x10	140x12x10	160x12x10	180x12x10	200x12x10	220x12x10	240x12x10	
	3 kg / 0,014 m ³	3 kg / 0,017 m ³	4 kg / 0,019 m ³	4 kg / 0,022 m ³	4 kg / 0,024 m ³	5kg / 0,026 m ³	5kg / 0,029 m ³	

* No se permiten devoluciones / Refund policy doesn't apply / Keine Rückgabe möglich / Pas de retours autorisés.

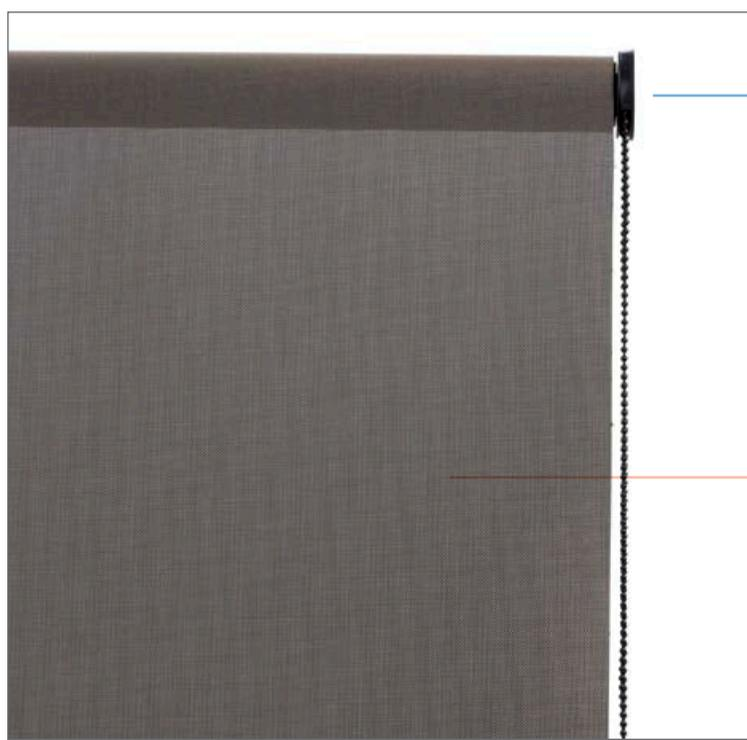

Acabado mecanismo / mechanism finishes
 (Color RAL/ RAL colour)

Ancho / Width
 Breite / Largeur

Altura
 Height
 Höhe
 Hauteur

ROLL 10-14 06 9005

Acabados tejidos / fabric finishes

ACABADOS TEJIDO

FABRIC FINISHES • STOFF DEKORE • FINITIONS TISSU

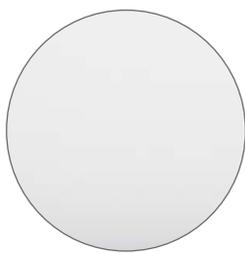

01
Blanco · White
Weiss · blanc

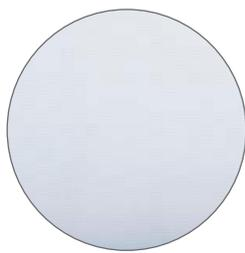

02
Blanco perla · Pearl white
Perle Weiss · Blanc perle



03
Perla · Pearl
Perle · Perle



04
Perla lino · Pearl flax
Pearl linen · Perle lin



05
Blanco lino · White flax
White linen · Blanc lin



06
Antracita bronce · Anthracite bronze
Anthrazit Bronze · Anthracite bronze



07
Antracita gris · Anthracite grey
Anthrazit Grau · Anthracite gris



08
Antracita · Anthracite
Anthrazit · Anthracite

ACABADOS MECANISMO

MECHANISM FINISHES • MECHANISMUS DEKORE • FINITIONS MÉCANISME

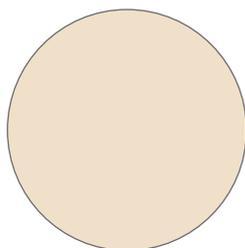

RAL 1013
Beige

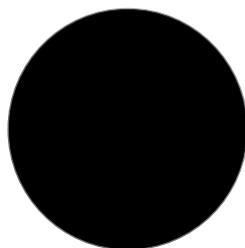

RAL 9005
Negro · Black
Schwarz · Noir

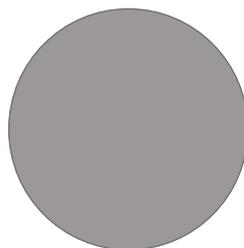

RAL 9006
Gris · Grey
Grau · Gris

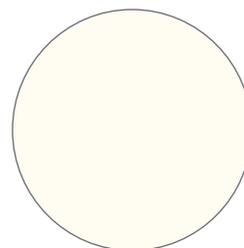

RAL 9010
Blanco · White
Weiss · Blanc

Factor de apertura: 5%
Limpieza: Con agua y jabón
Opening factor: 5%
Cleaning: With soap and water



MOBILIARIO DE OFICINA MULTIFUNCIONAL

MULTI-FUNCTIONAL OFFICE FURNITURE

RD-3055

[ESP] Información disponible en el catálogo VISUAL.

[ENG] Information available in the VISUAL catalogue.

[DE] Weitergehende Informationen im VISUAL-Katalog.

[FR] Information disponible dans le catalogue VISUAL.



RD-3050

[ESP] Información disponible en el catálogo VISUAL.

[ENG] Information available in the VISUAL catalogue.

[DE] Weitergehende Informationen im VISUAL-Katalog.

[FR] Information disponible dans le catalogue VISUAL.

RD-4036

[ESP] Información disponible en el catálogo VISUAL.

[ENG] Information available in the VISUAL catalogue.

[DE] Weitergehende Informationen im VISUAL-Katalog.

[FR] Information disponible dans le catalogue VISUAL.



MOBILIARIO DE OFICINA MULTIFUNCIONAL

MULTI-FUNCTIONAL OFFICE FURNITURE

RD-4037

[ESP] Información disponible en el catálogo VISUAL.

[ENG] Information available in the VISUAL catalogue.

[DE] Weitergehende Informationen im VISUAL-Katalog.

[FR] Information disponible dans le catalogue VISUAL.



RD-4020

[ESP] Información disponible en el catálogo VISUAL.

[ENG] Information available in the VISUAL catalogue.

[DE] Weitergehende Informationen im VISUAL-Katalog.

[FR] Information disponible dans le catalogue VISUAL.



RD-4030

[ESP] Información disponible en el catálogo VISUAL.

[ENG] Information available in the VISUAL catalogue.

[DE] Weitergehende Informationen im VISUAL-Katalog.

[FR] Information disponible dans le catalogue VISUAL.

ÍNDICE • INDEX



pag 6 • BLANCA



pag 22 • TOTAL



pag 38 • EXECUTIVE



pag 56 • METAL



pag 70 • WORK



pag 86 • E-TABLE



pag 92 • ACOUSTIC



pag 96 • STORE



pag 102 • STORE



pag 104 • STORE



pag 106 • STORE



pag 112 • STORE



pag 116 • STORE



pag 118 • STORE



pag 120 • STORE



pag 122 • WELCOME

ÍNDICE • INDEX



pag 131 • WELCOME



pag 132 • WELCOME



pag 134 • MEETING



pag 142 • MEETING



pag 144 • MEETING



pag 146 • MEETING



pag 147 • MEETING



pag 148 • ROLL

PEDIDOS

NOVEDAD WEB!

Los pedidos cursados vía web tendrán un 2% de descuento hasta fin de promoción.

Si los pedidos no se tramitan a través de la web deben de efectuarse siempre por escrito.

LISTA DE PRECIOS

Precios sin IVA.

Válidos a partir del 1 de febrero de 2019.

PAGOS

El incumplimiento del vencimiento del pago puede provocar la retención de nuevos pedidos hasta la cancelación del impago y la tramitación legal automática a través de nuestras empresas de cobro.

Anticipado 2%

GARANTÍA

2-5 años para todos los productos Rocada en condiciones de uso normales.

Rocada se compromete a entregar un producto de calidad conforme con las especificaciones requeridas.

PLAZOS DE ENTREGA

Máximo 7 días laborables para pedidos diarios.

TRANSPORTE

Portes para Península:

Pedido neto hasta 50 €: cargo de 10 € en concepto de portes.

A partir de 50 € hasta 150 €: 5 € en concepto de portes.

A partir de 150 €: portes pagados.

Portes para Canarias, Ceuta y Melilla: 800 €. El servicio de entrega de la mercancía solo se realizará hasta la puerta de la calle. Si es necesario entregar el material dentro de su destinación, la entrega tendrá un coste extra de +8% sobre PVP.

INCIDENCIAS Y DEVOLUCIONES

Avisar dentro de las 24 horas de la recepción de la mercancía para incidencias con el transporte. No se aceptarán incidencias pasadas las 24h desde la recepción. Y nunca se aceptaran devoluciones, sin previa confirmación desde Rocada.

JURISDICCIÓN

Para cuestión que pueda derivarse de la interpretación o aplicación de estas normas el cliente y Rocada se someten expresamente a la jurisdicción y fuero de los Juzgados y Tribunales de la ciudad de Barcelona, con renuncia a cualquier otro si lo hubiere.

ORDERS

All orders shall be received in writing.

PAYMENTS

All payments should be received on or before the due date indicated on the invoice. All customers shall be covered by CESCE insurance company. Rocada is forced to communicate any delay or nonpayment. Rocada is keen to offer an extra discount of -2% for in advance payments (before loading).

GUARANTEE

All Rocada products have between 2 and 5 years guarantee.

DELIVERY LEADTIME

Between 10-15 working days for stock orders. We shall inform the approximate delivery time once the order has been placed.

Each delivery shall be deemed a separate transaction and the failure of any one delivery shall not affect the due performance of the order. Any request to vary the quantity or delivery date of an order must be notified in writing. Ex-works prices.

CLAIMS - RETURN

All claims for damage to goods or partial loss of goods in transit must be submitted to, and received by us within 2 days of delivery.

No goods can be returned without prior notification and an official pick up note produced by us.

JURISDICTION

Spanish law only shall apply to this contract and all disputes shall be dealt with by the Spanish courts alone.

MODIFICACIONES / MODIFICATIONS

[ESP] Esta tarifa anula las anteriores. Nos reservamos el derecho de modificar sin previo aviso características, formas y medidas de nuestros productos. Tarifa válida excepto error tipográfico.

[ENG] This pricelist annuls all the previous ones. We reserve the right to change product specifications, sizes or colors without prior notice. Errors, omissions excluded.



Rocada Spain
rocada@rocada.com
www.rocada.com

Rocada Deutschland GmbH
info@rocada.de
www.rocada.de

Distribuido por / Distributed by:



Technic

Drawing your ideas

Calidad, confianza, responsabilidad
Quality, trust, responsibility
Qualität, Vertrauen, Verantwortung
Qualité, confiance, responsabilité



Todo el equipo de **Rocada** le da las gracias por su confianza en nuestros productos.
All **Rocada** Team would like to thank you for your confidence in our products.
Das gesamte **Rocada**-Team möchte sich bei Ihnen für Ihr Vertrauen in unsere Produkte bedanken.
Toute l'équipe **Rocada** vous remercie pour votre confiance en ses produits

Marc Roca
CEO

[ESP] Los productos presentados en este catálogo son reproducciones fotográficas impresas, por lo cual pueden ocasionarse leves variaciones de color en el resultado final. Así pues, este catálogo, aún asemejándose mucho a la realidad, sirve sólo a título orientativo.

Rocada se reserva el derecho de modificar sin previo aviso características, medidas y colores de nuestros productos.

[ENG] The products presented in this catalogue are printed photographic reproductions, so there can be colour variations in the end result. Although its contents bear a close resemblance to the actual products, the catalogue is therefore for guidance purposes only.

Rocada reserves the right to change product specifications, sizes or colors without prior notice.

[DE] Bei den in diesem Katalog abgebildeten Produkten handelt es sich um fotografische Wiedergaben, weshalb es hinsichtlich der Farben zu leichten Abweichungen vom Original kommen kann. Trotz weitestgehender Übereinstimmung mit dem Endprodukt ist dieser Katalog also rein informativ zu verstehen.

Rocada behält sich das Recht vor, Merkmale, Abmessungen und Farben der vorgestellten Produkte ohne Vorankündigung zu verändern.

[FR] Les produits présentés dans ce catalogue sont des reproductions photographiques imprimées ; de ce fait, il peut y avoir de légères variations de couleur dans le produit final. Ce catalogue, bien que très proche de la réalité, ne peut donc servir qu'à titre de référence.

Rocada se réserve le droit de modifier sans avis préalable les caractéristiques, les mesures et les couleurs de ses produits.

Stock permanente • Permanent stock Permanente Lagerhaltung • Stock permanent

[ESP] Rapidez • Eficacia • Stock permanente • Entrega inmediata

En un nuevo mundo globalizado, no puedes permitirte el lujo de malgastar espacio y tiempo, Rocada lo sabe. Una estructura de 20.000m² y un almacén de 5.000m² nos permiten disponer de un stock permanente de productos que asegura una entrega inmediata de 7 días.

[ENG] Speed • Efficiency • Permanent stock • Immediate delivery

In a new globalized world, one cannot permit himself the luxury of wasting space and time. Rocada knows this. A structure of 20,000 m² and a warehouse of 5,000 m² allows us to have the product available for immediate 7-day delivery.

[DE] Schnelligkeit • Wirksamkeit • Permanente Lagerung • Sofortige Lieferung

In einer neuen globalisierten Welt kann man sich den Luxus einer Platz- und Zeitverschwendung nicht erlauben. Rocada ist sich dessen bewusst. Ein Betriebsfläche mit 20.000m² und ein Warenlager von 5.000m² erlaubt es uns, über die Produkte zu verfügen und eine sofortige, 7-tägige Lieferung zu garantieren.

[FR] Rapidité • Efficacité • Stock permanent • Livraison immédiate

À l'heure de la mondialisation, vous ne pouvez plus vous permettre le luxe de mal gérer votre espace et votre temps. Rocada en est conscient. Une structure de 20000 m² et un entrepôt de 5000 m² nous permettent de disposer d'un stock permanent de produits afin de garantir une livraison rapide départ usine dans les 7 jours.



Servicio de montaje Montageservice

[ESP] Ofrecemos la posibilidad de montar cualquier material en cualquier punto del territorio español por un módico precio sin pedido mínimo.

[DE] Wir bieten Ihnen die Möglichkeit, unseren Montageservice in jedem Ort in Deutschland zu einem kleinen Aufpreis in Anspruch zu nehmen, unabhängig von der Höhe des Bestellwerts. Bitte erfragen Sie bei uns vorab die Höhe des Aufpreises.

Proyectos a medida Custom projects Benutzerdefinierte Projekte Projets personnalisés

[ESP] Ofrecemos la posibilidad de realizar proyectos a medida con material estándares de nuestro catálogo o con maderas y acabados especiales. Para más información consultar a Rocada.





[ESP] La certificación alemana GS reconocida a nivel mundial como una de las mejores a nivel europeo, garantiza la seguridad, calidad y continuidad de la fabricación del producto, dando al usuario una máxima seguridad y tranquilidad en su compra.

[ENG] GS German certification is world recognised as one of the best in Europe, a guarantee of safety, quality and product production continuity giving the user maximum security and peace of mind when purchasing.

[DE] Die deutsche GS-Zertifizierung ist weltweit als eine der besten europäischen Zertifizierungen anerkannt. Das GS-Zeichen steht für geprüfte Sicherheit, Qualität und Kontinuität der Warenproduktion und signalisiert dem Endverbraucher ein hohes Maß an Sicherheit.

[FR] La certification allemande GS est reconnue au niveau mondial comme une des meilleures en Europe. Elle garantit la sécurité, la qualité et le suivi de production du produit, elle assure au consommateur une sécurité maximale et la tranquillité par rapport à son achat.



ISO 9001:2015

[ESP] La calidad y fiabilidad de nuestros procesos de producción están avalados por la certificación ISO 9001:2015

[ENG] The quality and reliability of our production processes are guaranteed by ISO 9001:2015 certification.

[DE] Die Qualität und Zuverlässigkeit unserer Produktionsprozesse ist durch ISO 9001:2015

[FR] La qualité et la fiabilité de nos processus de production sont garanties par la certification ISO 9001:2015



ISO 14001:2015

[ESP] Respetar y proteger el medioambiente es prioritario en nuestros procesos productivos. El uso de productos reciclados y la utilización razonable de los recursos son prioridades

[ENG] Respect for and protection of the environment are priorities in our production processes. The use of recycled products and the reasonable use of resources are unbending priorities.

[DE] Der Umweltschutz gehört im Rahmen unserer Produktionsprozesse zu den zentralen Anliegen. Der Einsatz von Recyclingmaterialien und die vernünftige Nutzung von natürlichen Ressourcen steht für uns an erster Stelle.

[FR] Respecter et protéger l'environnement est une priorité pour nos processus de production. L'utilisation de matières recyclées et l'utilisation raisonnable des ressources sont des priorités essentielles.



MESAS DIBUJO

DRAWING TABLES • ZEICHNUNGSTISCHE • TABLES À DESSIN

[ESP] Mesa de dibujo profesional. Estructura metálica de gran resistencia apta para trabajar con tableros y tecnígrafos de hasta 3 metros. La regulación del tablero se ejecuta con la palanca del pie muy fácilmente con unos muelles. Incorpora niveladores. Fácil montaje. No incluye tablero.

[ENG] Professional drawing table. High resistance metallic structure suitable for working with boards and technigraphs of up to 3 metres. The adjustment of the board is very easily carried out through the foot pedal with springs. Incorporates levellers. Easy assembling. Table top is not included.

[DE] Extra standfester Zeichentisch. Höhen- und Neigungsverstellung mittels Fußpedal. Zeichenplatten nicht inbegriffen.

[FR] Table à dessin professionnelle, structure métal très solide. Pour plateaux et appareils à dessiner jusqu'à 3 mètres. Le réglage de la table se fait très facilement à l'aide du levier actionné par le pied, grâce à un système de ressorts. Comprend des dispositifs de mise à niveau. Montage facile. N'inclut pas le plateau.



Tableros opcionales
Optional boards
Verwendbare Plattengrößen
Plateaux en option

RD804 · 90x130 cm.
RD805 · 100x150 cm.
RD806 · 100x170 cm.



Medidas / Sizes (cm)

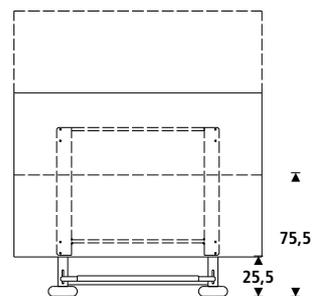
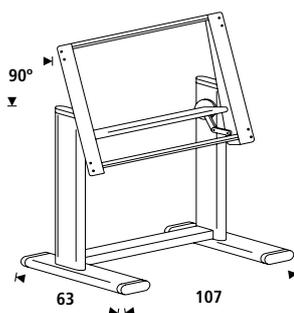
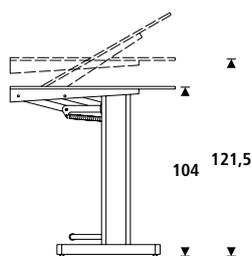

Ref.	cm (embalaje / packaging)	kg / m ³ (embalaje / packaging)
RD-110	106x27x101	58,25 kg / 0,289 m ³

MESAS DIBUJO

DRAWING TABLES • ZEICHNUNGSTISCHE • TABLES À DESSIN

[ESP] Mesa de dibujo profesional. Estructura metálica fija de gran resistencia apta para trabajar con tableros y tecnígrafos de hasta 170cm. Regulable hasta 108cm. Incorpora bandeja de serie debajo del tablero y nivelador. Fácil montaje. No incluye tablero.

[ENG] Professional drawing table. High resistance metallic structure suitable for a completely flat level of 78cm height adjustable to 108cm or as a drawing board and technigraphs up to 170 cm. Incorporates serial tray underneath the board and leveler. Easy assembling. Table top is not included.

[DE] Zeichentisch mit zusätzlicher Ablage. Tisch kann auch als Arbeitstisch (78 cm Tischhöhe) genutzt werden. Zeichenplatten nicht inbegriffen.

[FR] Table à dessin professionnelle, structure très solide pour travailler complètement à plat à 78cm, réglable jusqu'à 108cm, ou comme table à dessin et appareils à dessins jusqu'à 170 cm. Avec plateau de rangement en série sous la table et dispositifs de mise à niveau. Montage facile. Le plateau n'est pas inclus.



Tableros opcionales
Optional boards
Verwendbare Plattengrößen
Plateaux en option

- RD 803 · 80x120 cm.
- RD 804 · 90x130 cm.
- RD 805 · 100x150 cm.
- RD 806 · 100x170 cm.



Medidas / Sizes (cm)

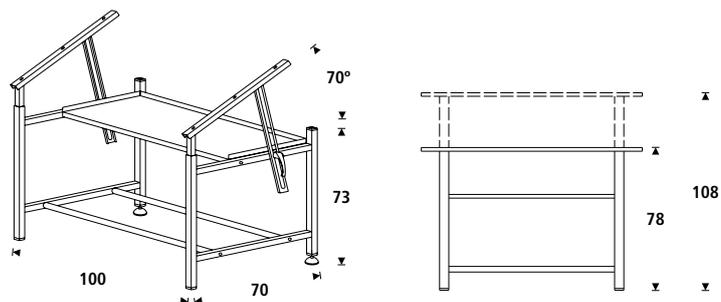

Ref.	cm (embalaje / packaging)	kg / m ³ (embalaje / packaging)
RD-135	95x77x15	22,7 kg / 0,110 m ³

MESAS DIBUJO

DRAWING TABLES • ZEICHNUNGSTISCHE • TABLES À DESSIN

[ESP] Mesa de dibujo semi-profesional. Estructura metálica plegable apta para trabajar con tableros y tecnígrafos hasta 130 cm. La regulación del tablero se ejecuta mediante muelles. Incorpora nivelador. Fácil montaje. No incluye tablero.

[ENG] Semi-professional drawing table. Metallic folding structure suitable for working with boards of medium sized technigraphs up to 130 cm. The table adjustment is carried out through springs. Incorporates leveler. Easy assembling. Table top is not included.

[DE] Semi-professioneller Zeichentisch für mittelgroße Zeichenmaschinen. Höhenverstellung wird durch Federn unterstützt. Mit Ablagekorb. Zeichenplatten nicht inbegriffen.

[FR] Table à dessin semi-professionnelle, structure pliable du métal conçue pour travailler sur des plateaux et des appareils à dessins jusqu'à 130 cm. Le réglage de la table se fait à l'aide de ressorts. Dispositif de mise à niveau. Montage facile. Le plateau n'est pas inclus.



Tableros opcionales
Optional boards
Verwendbare Plattengrößen
Plateaux en option

RD 801 · 65x90 cm.
RD 802 · 75x100 cm.
RD 803 · 80x120 cm.
RD 804 · 90x130 cm.

Mesa plegable
Folding table

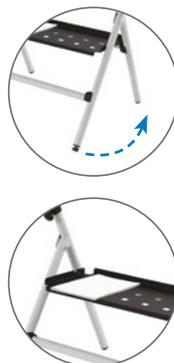

Medidas / Sizes (cm)

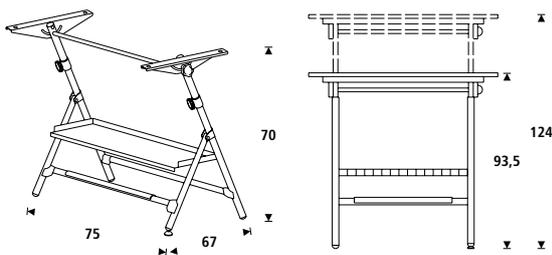

Ref.	cm (embalaje / packaging)	kg / m ³ (embalaje / packaging)
RD-175	85x13x88	13 kg / 0,097 m ³

MESAS DIBUJO

DRAWING TABLES • ZEICHNUNGSTISCHE • TABLES À DESSIN

[ESP] Mesa de dibujo para estudiante. Estructura metálica plegable apta para trabajar con tableros y tecnígrafos hasta 130 cm. La regulación del tablero se ejecuta mediante fuerza. Incorpora nivelador. Fácil montaje. No incluye tablero.

[ENG] Drawing table for students. Metallic folding structure suitable for working with boards of small sized technigraphs up to 130 cm. The table adjustment is carried out through force. Incorporates leveler. Easy assembling. Table top is not included.

[DE] Zeichentisch mit einfacher Höhen- und Neigungsverstellung für Schüler und Studenten. Zeichenplatten nicht inbegriffen.

[FR] Table à dessin pour étudiant, structure pliable du métal conçue pour travailler avec des plateaux et des appareils à dessins jusqu'à 130 cm. Le réglage de la table se fait manuellement. Dispositif de mise à niveau. Montage facile. Le plateau n'est pas inclus.



Tableros opcionales
Optional boards
Verwendbare Plattengrößen
Plateaux en option

RD 801 · 65x90 cm.
RD 802 · 75x100 cm.
RD 803 · 80x120 cm.
RD 804 · 90x130 cm.

Mesa plegable
Folding table



Medidas / Sizes (cm)

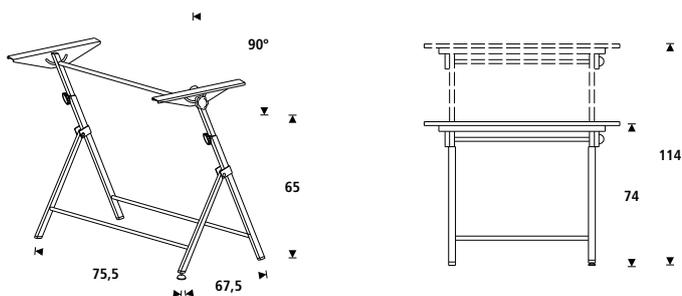

Ref.	cm (embalaje / packaging)	kg / m ³ (embalaje / packaging)
RD-190	90x81x13,5	12,95 kg / 0,098 m ³

MESAS DIBUJO

DRAWING TABLES • ZEICHNUNGSTISCHE • TABLES À DESSIN

[ESP] Kit de dibujo para estudiantes. Incorpora: mesa RD-190 + tablero RD-803 (80 x 120 cm) + bandeja lápices RD-700 y taburete con ruedas y reposapies RD-980. Fácil montaje.

[ENG] Drawing kit for students. Table RD-190 + top RD-803 (80 x 120 cm) + pen tray RD-700 and stool RD-980 with castors and footrest. Easy assembling.

[DE] Zeichenset für Studenten. Beinhaltet Tisch RD-190 plus Tafel 80x120 cm sowie Lineal, Bleistiftablage und Stuhl mit Fußstütze. Lieferung in einem Gesamtpaket.

[FR] Kit de dessin pour étudiants: comprend table RD-190 + plateau RD-803 (80 x 120 cm) + auget RD-700 et siège avec repode-pieds et roues RD-980. Montage facile.



Medidas / Sizes (cm)

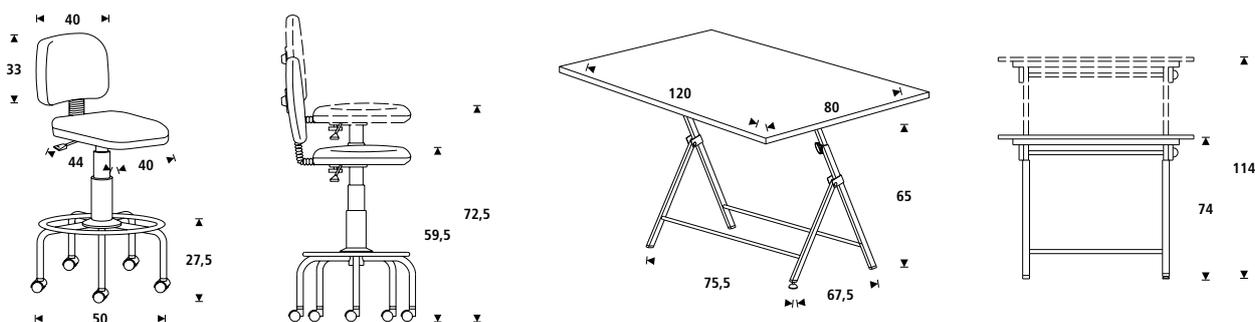

Ref.	cm (embalaje / packaging)	kg / m ³ (embalaje / packaging)
RD-030	127x83x25	32 kg / 0,264 m ³

COMPLEMENTOS DIBUJO

DRAWING ACCESSORIES • ZUBEHÖR ZEICHENTECHNIK • ACCESSOIRES DESSIN

[ESP] Tecnógrafos de aluminio de gran calidad. Incorpora grupo goniómetro de 360° y pulsadora de saltos a cada 15°. Fácil montaje.

[DE] Hochwertige Zeichenmaschine aus Aluminium. Mit 360° Goniometergruppe und Springschalter jede 15°.

[ENG] High quality aluminium technigraph. Includes a 360° goniometer group and a hopper switch each 15°. Easy assembling.

[FR] Appareils à dessiner en aluminium de grand qualité. Avec tête de 360°, et encliquetage de 15°.



Para tableros / For table top:

- RD 1200 · 80x120 cm.
- RD 1201 · 90x130 cm.
- RD 1202 · 100x150 cm.
- RD 1203 · 100x170 cm.

Medidas / Sizes (cm)

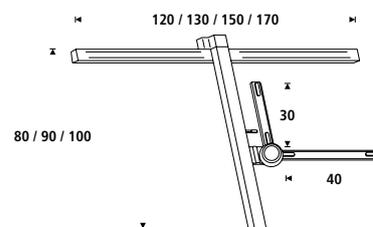

Ref.	cm (embalaje / packaging)	kg / m ³ (embalaje / packaging)
RD-1200	123x22x15	6,70 kg / 0,039 m ³
RD-1201	143x22x15	7,10 kg / 0,047 m ³
RD-1202	156x22x15	7,60 kg / 0,055 m ³
RD-1203	176x22x15	7,85 kg / 0,057 m ³

COMPLEMENTOS DIBUJO

DRAWING ACCESSORIES • ZUBEHÖR ZEICHENTECHNIK • ACCESSOIRES DESSIN

[ESP] Tableros blancos para las mesas dibujo. Fácil montaje.

[DE] Zeichentischplatten.

[ENG] White surface boards for drawing tables.

[FR] Plateaux blancs pour tables à dessin.



Tableros de dibujo de 16mm
Table top of 16mm thickness

- RD 801 · 65x90 cm.
- RD 802 · 75x100 cm.
- RD 803 · 80x120 cm.
- RD 804 · 90x130 cm.
- RD 805 · 100x150 cm.
- RD 806 · 100x170 cm.

Medidas / Sizes (cm)

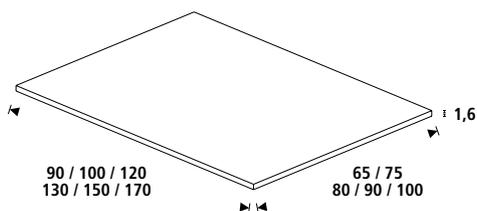

	Ref.	cm (embalaje / packaging)	kg / m ³ (embalaje / packaging)
embalaje individual individual packaging	RD-801	106x80x3	7,7 kg / 0,025 m ³
	RD-802	106x80x3	9,4 kg / 0,025 m ³
	RD-803	126x105x3	10,3 kg / 0,039 m ³
	RD-804	136x105x3	14,5 kg / 0,043 m ³
	RD-805	156x105x3	16,5 kg / 0,049 m ³
	RD-806	176x105x3	18,5 kg / 0,055 m ³
embalaje colectivo bulk packaging Min. 25 u.	RD-801Pack	-	-
	RD-802Pack	-	-
	RD-803Pack	-	-
	RD-804Pack	-	-
	RD-805Pack	-	-
	RD-806Pack	-	-

COMPLEMENTOS DIBUJO

DRAWING ACCESSORIES • ZUBEHÖR ZEICHENTECHNIK • ACCESSOIRES DESSIN

[ESP] Paralex acrílico para los tableros de dibujo.

[ENG] Acrylic paralex for all drawing tables.

[DE] Acryl Lineal für Zeichentische.

[FR] Règle parallèle en acrylique pour les plateaux à dessin.



Ref.	cm.
RD-1101	50 cm.
RD-1102	60 cm.
RD-1103	70 cm.
RD-1104	80 cm.
RD-1105	90 cm.
RD-1106	100 cm.
RD-1108	120 cm.
RD-1110	140 cm.
RD-1111	150 cm.

[ESP] Bandeja metálica para portalápices. Fácil montaje.

[ENG] Metallic pencil holder tray. Easy assembling.

[DE] Metallablage für Bleistifthalter.

[FR] Auget métallique pour crayons.

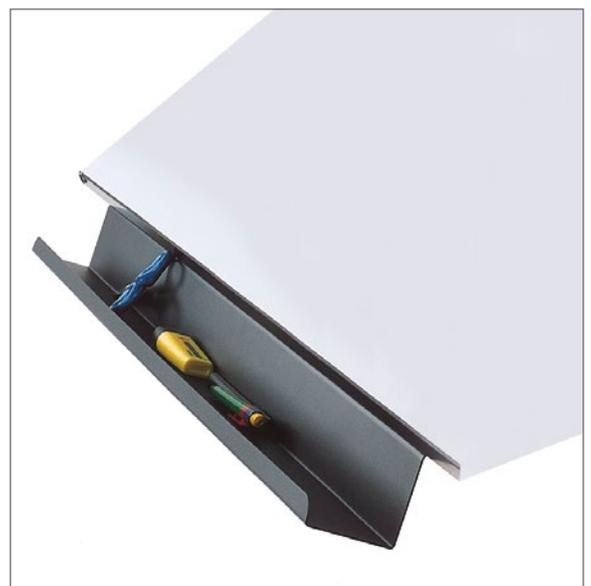

Medidas / Sizes (cm)

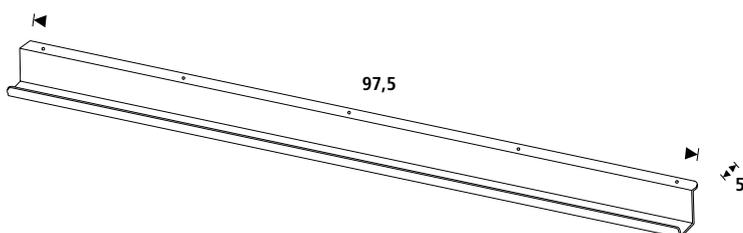

Ref.	cm (embalaje / packaging)	kg / m ³ (embalaje / packaging)
RD-700	102,5x10x7	1,2 kg / 0,007 m ³

CARRO MÓVIL PARA PLANOS

MOBILE TROLLEY FOR PLANS • MOBILER ZEICHENTROLLEY
CHARIOT MOBILE POUR PLANS

[ESP] Carro de estructura metálica con ruedas; permite la sujeción de 10 brazos. Cada brazo admite 10 planos A0. Estos brazos son de fácil extracción para permitir una consulta ágil y cómoda en cualquier momento. Fácil montaje.

[ENG] Metallic structure trolley with castors that permits the storage of 10 A0 plans, extendable arms which are easily extracted for plan consultation. Easy assembling.

[DE] Mobiler Zeichentrolley (RD 236)für die Aufnahme von bis zu 10 ausziehbaren Planhalterungen. Je Planhalterung kann max. bis zu 20 Pläne (A0, A 1, A 2) aufnehmen. Die Planhalterungen (RD 237) sind separat zu bestellen, VE á 5 St.

[FR] Chariot à structure métallique avec roulettes, permettant d'accrocher 10 cartes de taille A0 grâce à ses bras individuels. Ces bras peuvent être facilement retirés afin de faciliter la consultation à tout moment. Facile à monter.



RD-236
Solo estructura
Only structure

RD-237 (A0) Pack 5u.
Brazos de aluminio / Aluminium arms



Medidas / Sizes (cm)

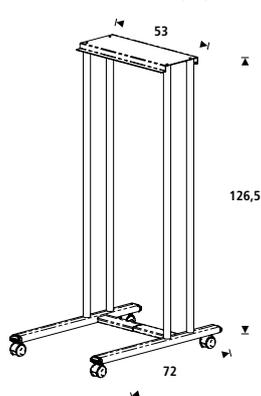

Ref.	cm (embalaje / packaging)	kg / m ³ (embalaje / packaging)
RD-236	126x32x8,5	14,75 kg / 0,034 m ³
RD-237 (5u.)	99x11x11	3 kg / 0,012 m ³

ARCHIVO TÉCNICO

TECHNICAL FILE • TECHNISCHES ARCHIV • ARCHIVAGE TECHNIQUE

[ESP] Archivador vertical de planos de estructura de melamina de gran resistencia. La tapa superior se abre mediante pistones de muelles y la tapa frontal mediante 1 tirador de aluminio con un sistema de 2 chapas freno-guía cromadas. Incorpora sistema de antivuelco y cierre. Viene montado.

[ENG] Vertical filing cabinet for plans with a high resistance melamine structure. The top cover opens through spring pistons and the front cover with 1 aluminium handle with a 2 plate chrome band-brake. Incorporates overturn-safe system, locking system. Comes assembled.

[DE] Archivschrank aus Holz für die vertikale Lagerung von Zeichnungen bis Format A0. Frontseite für leichtes Verstauen abklappbar.

[FR] Meuble à plans vertical à structure mélaminée haute résistance. Le couvercle supérieur s'ouvre à l'aide de pistons à ressorts et le capot avant à l'aide d'une poignée en aluminium avec un système à 2 tôles chromées de freinage-guidage. Comprend un système anti-renversement. Vient montée.



**DISCONTINUED
DESCATALOGADO**

RD 250 / RD 260

Tiras de suspensión para planos.
Supporting strips for plans.
Hängehüllen für Zeichnungen.
Bandes de suspension pour plans.



Medidas / Sizes (cm)

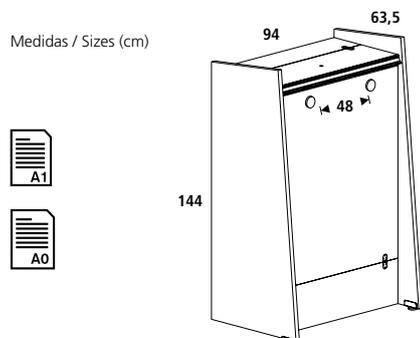

Para/For RD-235

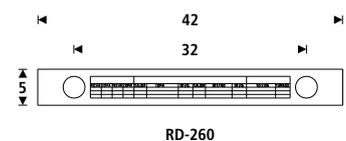

Ref.	cm (embalaje / packaging)	kg / m ³ (embalaje / packaging)
RD-235	145x95x65	99,25 kg / 0,895 m ³
RD-250 (50 u.)	DIN A0	-

ARCHIVO TÉCNICO

TECHNICAL FILE • TECHNISCHES ARCHIV • ARCHIVAGE TECHNIQUE

[ESP] Archivador horizontal de planos de estructura de melamina de gran resistencia. Los 5 cajones incorporan tiradores de aluminio y llevan sistema de cerradura. La estructura interna, así como los cajones, son metálicos. Permiten ser remontados sin el soporte RD-226. Viene montado.

[ENG] Horizontal high resistance melamine structure filing cabinet for plans. The 5 drawers include aluminium handles and has a locking system. The internal structure, as well as the drawers, are metallic. It can be remounted without the support RD226. Comes assembled.

[DE] Archivschrank zur waagerechten Lagerung von Zeichnungen. 5 Metallschubladen mit Aluminiumgriffen und Verriegelungssystem“

[FR] Meuble à plans horizontal de plans à structure mélaminée haute résistance. Les 5 tiroirs sont équipés de poignées en aluminium avec un système de serrure. La structure interne ainsi que les tiroirs sont métalliques. Le meuble peut être rehaussé sans le support RD-226. Vient montée.



RD-226

Soporte de melamina para los archivadores RD-225. Fácil montaje.
Melamine support for the files RD-225. Easy assembling.
Unter gestell für Archivschrank RD-225.
Support en mélamine pour rehausser les meubles à plans RD-225. Montage facile.

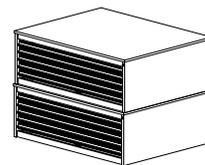

Max 2u

RD 220



Divisores interiores
Inner dividers

Medidas / Sizes (cm)

RD 225

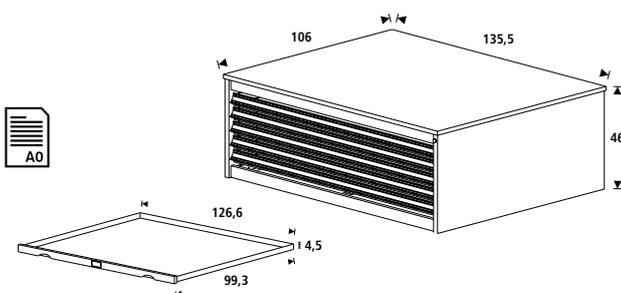

RD 220

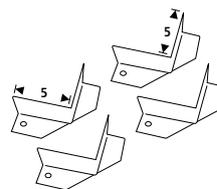

RD 226

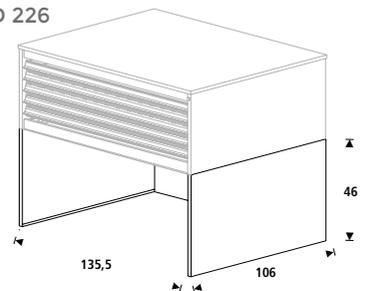

Ref.	cm (embalaje / packaging)	kg / m ³ (embalaje / packaging)
RD-225	148x112x66	143,65 kg / 1,094 m ³
RD-226	140x51x15	29,70 kg / 0,107 m ³
RD-220	-	-

TABURETES

STOOLS • HOCKER • TABOURETS

RD-925N

[ESP] Información disponible en el catálogo ERGOLINE.

[ENG] Information available in the ERGOLINE catalogue.

[DE] Weitergehende Informationen im ERGOLINE-Katalog.

[FR] Information disponible dans le catalogue ERGOLINE.



RD-900

[ESP] Información disponible en el catálogo ERGOLINE.

[ENG] Information available in the ERGOLINE catalogue.

[DE] Weitergehende Informationen im ERGOLINE-Katalog.

[FR] Information disponible dans le catalogue ERGOLINE.

RD-980

[ESP] Información disponible en el catálogo ERGOLINE.

[ENG] Information available in the ERGOLINE catalogue.

[DE] Weitergehende Informationen im ERGOLINE-Katalog.

[FR] Information disponible dans le catalogue ERGOLINE.



ÍNDICE • INDEX



pag 6 · RD-110



pag 7 · RD-135



pag 8 · RD-175



pag 9 · RD-190



pag 10 · RD-030



pag 11 · RD-1200



pag 12 · RD-801

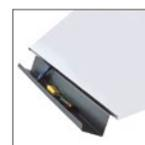

pag 13 · RD-1106 / RD-700



pag 14 · RD-236



pag 15 · RD-235



pag 16 · RD-225 / RD-226

PEDIDOS

NOVEDAD WEB!

Los pedidos cursados vía web tendrán un 2% de descuento hasta fin de promoción.
Si los pedidos no se tramitan a través de la web deben de efectuarse siempre por escrito.

LISTA DE PRECIOS

Precios sin IVA.
Válidos a partir del 1 de febrero de 2019.

PAGOS

El incumplimiento del vencimiento del pago puede provocar la retención de nuevos pedidos hasta la cancelación del impago y la tramitación legal automática a través de nuestras empresas de cobro.
Anticipado 2%

GARANTÍA

2-5 años para todos los productos Rocada en condiciones de uso normales.
Rocada se compromete a entregar un producto de calidad conforme con las especificaciones requeridas.

PLAZOS DE ENTREGA

Máximo 7 días laborables para pedidos diarios.

TRANSPORTE

Portes para Península:
Pedido neto hasta 50 €: cargo de 10 € en concepto de portes.
A partir de 50 € hasta 150 €: 5 € en concepto de portes.
A partir de 150 €: portes pagados.
Portes para Canarias, Ceuta y Melilla: 800 €. El servicio de entrega de la mercancía solo se realizará hasta la puerta de la calle. Si es necesario entregar el material dentro de su destinación, la entrega tendrá un coste extra de +8% sobre PVP.

INCIDENCIAS Y DEVOLUCIONES

Avisar dentro de las 24 horas de la recepción de la mercancía para incidencias con el transporte. No se aceptarán incidencias pasadas las 24h desde la recepción. Y nunca se aceptaran devoluciones, sin previa confirmación desde Rocada.

JURISDICCIÓN

Para cuestión que pueda derivarse de la interpretación o aplicación de estas normas el cliente y Rocada se someten expresamente a la jurisdicción y fuero de los Juzgados y Tribunales de la ciudad de Barcelona, con renuncia a cualquier otro si lo hubiere.

ORDERS

All orders shall be received in writing.

PAYMENTS

All payments should be received on or before the due date indicated on the invoice. All customers shall be covered by CESCE insurance company. Rocada is forced to communicate any delay or nonpayment. Rocada is keen to offer an extra discount of -2% for in advance payments (before loading).

GUARANTEE

All Rocada products have between 2 and 5 years guarantee.

DELIVERY LEADTIME

Between 10-15 working days for stock orders. We shall inform the approximate delivery time once the order has been placed. Each delivery shall be deemed a separate transaction and the failure of any one delivery shall not affect the due performance of the order. Any request to vary the quantity or delivery date of an order must be notified in writing. Ex-works prices.

CLAIMS - RETURN

All claims for damage to goods or partial loss of goods in transit must be submitted to, and received by us within 2 days of delivery. No goods can be returned without prior notification and an official pick up note produced by us.

JURISDICTION

Spanish law only shall apply to this contract and all disputes shall be dealt with by the Spanish courts alone.

MODIFICACIONES / MODIFICATIONS

[ESP] Esta tarifa anula las anteriores. Nos reservamos el derecho de modificar sin previo aviso características, formas y medidas de nuestros productos. Tarifa válida excepto error tipográfico.

[ENG] This pricelist annuls all the previous ones. We reserve the right to change product specifications, sizes or colors without prior notice. Errors, omissions excluded.



Rocada Spain
rocada@rocada.com
www.rocada.com

Rocada Deutschland GmbH
info@rocada.de
www.rocada.de

Distribuido por / Distributed by:



Visualline

The power of communication

Calidad, confianza, responsabilidad
Quality, trust, responsibility
Qualität, Vertrauen, Verantwortung
Qualité, confiance, responsabilité



Todo el equipo de **Rocada** le da las gracias por su confianza en nuestros productos.
All **Rocada** Team would like to thank you for your confidence in our products.
Das gesamte **Rocada**-Team möchte sich bei Ihnen für Ihr Vertrauen in unsere Produkte bedanken.
Toute l'équipe **Rocada** vous remercie pour votre confiance en ses produits

Marc Roca
CEO

[ESP] Los productos presentados en este catálogo son reproducciones fotográficas impresas, por lo cual pueden ocasionarse leves variaciones de color en el resultado final. Así pues, este catálogo, aún asemejándose mucho a la realidad, sirve sólo a título orientativo.

Rocada se reserva el derecho de modificar sin previo aviso características, medidas y colores de nuestros productos.

[ENG] The products presented in this catalogue are printed photographic reproductions, so there can be colour variations in the end result. Although its contents bear a close resemblance to the actual products, the catalogue is therefore for guidance purposes only.

Rocada reserves the right to change product specifications, sizes or colors without prior notice.

[DE] Bei den in diesem Katalog abgebildeten Produkten handelt es sich um fotografische Wiedergaben, weshalb es hinsichtlich der Farben zu leichten Abweichungen vom Original kommen kann. Trotz weitestgehender Übereinstimmung mit dem Endprodukt ist dieser Katalog also rein informativ zu verstehen.

Rocada behält sich das Recht vor, Merkmale, Abmessungen und Farben der vorgestellten Produkte ohne Vorankündigung zu verändern.

[FR] Les produits présentés dans ce catalogue sont des reproductions photographiques imprimées ; de ce fait, il peut y avoir de légères variations de couleur dans le produit final. Ce catalogue, bien que très proche de la réalité, ne peut donc servir qu'à titre de référence.

Rocada se réserve le droit de modifier sans avis préalable les caractéristiques, les mesures et les couleurs de ses produits.

Stock permanente • Permanent stock Permanente Lagerhaltung • Stock permanent

[ESP] Rapidez • Eficacia • Stock permanente • Entrega inmediata

En un nuevo mundo globalizado, no puedes permitirte el lujo de malgastar espacio y tiempo, Rocada lo sabe. Una estructura de 20.000m² y un almacén de 5.000m² nos permiten disponer de un stock permanente de productos que asegura una entrega inmediata de 7 días.

[ENG] Speed • Efficiency • Permanent stock • Immediate delivery

In a new globalized world, one cannot permit himself the luxury of wasting space and time. Rocada knows this. A structure of 20,000 m² and a warehouse of 5,000 m² allows us to have the product available for immediate 7-day delivery.

[DE] Schnelligkeit • Wirksamkeit • Permanente Lagerung • Sofortige Lieferung

In einer neuen globalisierten Welt kann man sich den Luxus einer Platz- und Zeitverschwendung nicht erlauben. Rocada ist sich dessen bewusst. Ein Betriebsfläche mit 20.000m² und ein Warenlager von 5.000m² erlaubt es uns, über die Produkte zu verfügen und eine sofortige, 7-tägige Lieferung zu garantieren.

[FR] Rapidité • Efficacité • Stock permanent • Livraison immédiate

À l'heure de la mondialisation, vous ne pouvez plus vous permettre le luxe de mal gérer votre espace et votre temps. Rocada en est conscient. Une structure de 20000 m² et un entrepôt de 5000 m² nous permettent de disposer d'un stock permanent de produits afin de garantir une livraison rapide départ usine dans les 7 jours.



Servicio de montaje Montageservice

[ESP] Ofrecemos la posibilidad de montar cualquier material en cualquier punto del territorio español por un módico precio sin pedido mínimo.

[DE] Wir bieten Ihnen die Möglichkeit, unseren Montageservice in jedem Ort in Deutschland zu einem kleinen Aufpreis in Anspruch zu nehmen, unabhängig von der Höhe des Bestellwerts. Bitte erfragen Sie bei uns vorab die Höhe des Aufpreises.

Proyectos a medida Custom projects Benutzerdefinierte Projekte Projets personnalisés

[ESP] Ofrecemos la posibilidad de realizar proyectos a medida con material estándares de nuestro catálogo o con maderas y acabados especiales. Para más información consultar a Rocada.





[ESP] La certificación alemana GS reconocida a nivel mundial como una de las mejores a nivel europeo, garantiza la seguridad, calidad y continuidad de la fabricación del producto, dando al usuario una máxima seguridad y tranquilidad en su compra.

[ENG] GS German certification is world recognised as one of the best in Europe, a guarantee of safety, quality and product production continuity giving the user maximum security and peace of mind when purchasing.

[DE] Die deutsche GS-Zertifizierung ist weltweit als eine der besten europäischen Zertifizierungen anerkannt. Das GS-Zeichen steht für geprüfte Sicherheit, Qualität und Kontinuität der Warenproduktion und signalisiert dem Endverbraucher ein hohes Maß an Sicherheit.

[FR] La certification allemande GS est reconnue au niveau mondial comme une des meilleures en Europe. Elle garantit la sécurité, la qualité et le suivi de production du produit, elle assure au consommateur une sécurité maximale et la tranquillité par rapport à son achat.



ISO 9001:2015

[ESP] La calidad y fiabilidad de nuestros procesos de producción están avalados por la certificación ISO 9001:2015

[ENG] The quality and reliability of our production processes are guaranteed by ISO 9001:2015 certification.

[DE] Die Qualität und Zuverlässigkeit unserer Produktionsprozesse ist durch ISO 9001:2015

[FR] La qualité et la fiabilité de nos processus de production sont garanties par la certification ISO 9001:2015



ISO 14001:2015

[ESP] Respetar y proteger el medioambiente es prioritario en nuestros procesos productivos. El uso de productos reciclados y la utilización razonable de los recursos son prioridades

[ENG] Respect for and protection of the environment are priorities in our production processes. The use of recycled products and the reasonable use of resources are unbending priorities.

[DE] Der Umweltschutz gehört im Rahmen unserer Produktionsprozesse zu den zentralen Anliegen. Der Einsatz von Recyclingmaterialien und die vernünftige Nutzung von natürlichen Ressourcen steht für uns an erster Stelle.

[FR] Respecter et protéger l'environnement est une priorité pour nos processus de production. L'utilisation de matières recyclées et l'utilisation raisonnable des ressources sont des priorités essentielles.



SkinWhiteBoard

unlimited whiteboard



Skinwhiteboard, unlimited whiteboard





¿Qué es?

What is it? / SkinWHITEBOARD, Das rahmenlose Endloswhiteboard-System
Qu'est ce que c'est?

[ESP] El SkinWHITEBOARD es un panel multifuncional y pizarra modular, que gracias a su diseño moderno sin marco y con fijación magnética, permite colocarlas en vertical y horizontal haciendo posibles infinitas composiciones, desde una unidad hasta cubrir una pared, creciendo según sus necesidades. Además, sus acabados y complementos aumentan su funcionalidad con múltiples usos.

- Superficie realizada en chapa de acero de 1mm de espesor
- Bandeja para rotuladores realizada en chapa de acero de 1mm de espesor
- No tiene marco
- Plantilla de instalación realizada en cartón (facilita el proceso de instalación)

[DE] Beliebige große Whiteboard-Flächen ohne störende Zwischenrahmen- die innovativen Skin Whiteboard Module ermöglichen eine funktionelle und beliebig große Form der Wandausgestaltung: Als großzügige Schreibfläche, als Kreativwand, als Ausstellungsfläche, als Organisationsmittel... Das klare, rahmenlose Tafel-Design ermöglicht eine fast ansatzlose Flächenausgestaltung, auch im 90° Winkel über Eck. Skin whiteboards können wahlweise horizontal oder vertikal auf Stoß montiert werden. Transport und Montage sind aufgrund des modularen Prinzips und eines magnetischen Montagesystems einfach, schnell und passgenau von nur einer Person zu bewerkstelligen.

- Oberfläche und Ablageboard aus 1mm starkem Stahlblech
- Beliebige große Flächen mit nur zwei Standard Modulmaßen
- Magnethaftend
- Oberfläche mit Boardmarkern trocken oder feucht abwischbar
- Zwei Oberflächenqualitäten: Skin / Skin Color und Skin PRO
- Rahmenloses, puristisches Tafeldesign
- GS geprüft

[ENG] The SkinWHITEBOARD is a multifunctional panel and modular whiteboard which, thanks to its modern, frameless design, and magnetic securing, can be placed either vertically or horizontally. This enables greater flexibility on size and layout, from a single unit up to covering a whole wall, modify as needed. In addition a choice of finishes and accessories increase functionality with a myriad of uses.

- Surface made of 1 mm thick sheet steel
- Pen tray made of 1 mm thick sheet steel
- Frameless
- Cardboard Installation template (to facilitate the installation process)

[FR] Le SkinWHITEBOARD est très fonctionnel et modulable. Grâce à son design sans cadre et son système d'accroche innovant, il peut être positionné verticalement ou horizontalement. C'est un produit avec une grande flexibilité. Avec une seule référence il est possible de recouvrir un mur entier. Un grand nombre d'accessoires permet de rendre nos tableaux encore plus fonctionnels.

- Surface fait dans une feuille d'acier d'1 mm d'épaisseur.
- Plumier fait dans une feuille d'acier d'1 mm d'épaisseur.
- Sans cadre.
- Gabarit fourni.





3 medidas estándares / 3 standard sizes
 55x75x1cm · 75x115x1cm · 100x150x1cm

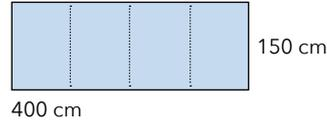
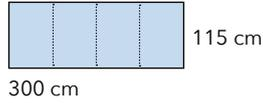
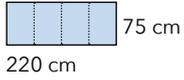
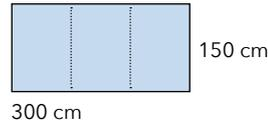
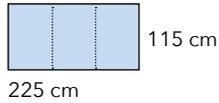
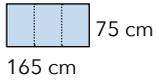
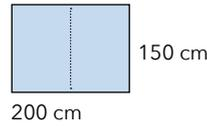
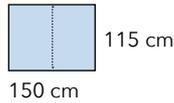
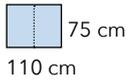
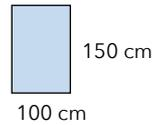
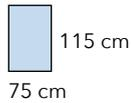
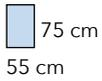

Otros ejemplos / Other examples

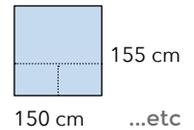
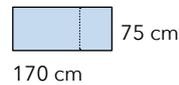
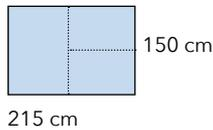
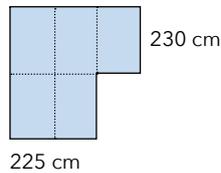
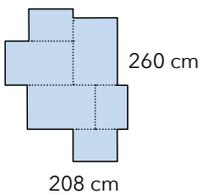

Con 3 SkinWhiteBoard 55x75 cm
 + 3 SkinWhiteBoard 75x115 cm.
 With 3 SkinWhiteBoard 55x75 cm
 + 3 SkinWhiteBoard 75x115 cm.

Con 5 SkinWhiteBoard 75x115 cm.
 With 5 SkinWhiteBoard 75x115 cm.

Con 2 SkinWhiteBoard 75x115 cm
 + 1 SkinWhiteBoard 100x150 cm.
 With 2 SkinWhiteBoard 75x115 cm
 + 1 SkinWhiteBoard 100x150 cm.

Con 1 SkinWhiteBoard 75x115 cm
 + 1 SkinWhiteBoard 55x75 cm.
 With 1 SkinWhiteBoard 75x115 cm
 + 1 SkinWhiteBoard 55x75 cm.

Con 1 SkinWhiteBoard 100x150 cm
 + 2 SkinWhiteBoard 55x75 cm.
 With 1 SkinWhiteBoard 100x150 cm
 + 2 SkinWhiteBoard 55x75 cm.

¡Fácil transporte!

Easy to transport! / Einfacher Transport! / Facile à transporter!

[ESP] Los paneles **SkinWHITEBOARD** pueden ser:

- Transportados en coche
- Movidos por una sola persona
- Subidos en el ascensor
- Instalados por una persona no especializada
- Sin bordes
- Ilimitados
- Plazos de entrega cortos
- Sin incidencias de transporte

[DE] Insbesondere gegenüber großflächigen Einzeltafeln bieten skin whiteboards folgende Vorteile:

- Transport sogar im PKW möglich
- Ein-Personen-Handling
- Im Fahrstuhl transportierbar
- Keine speziellen Montagekenntnisse erforderlich
- Keine Maximal-Abmessungen
- Kurzfristige Lieferzeiten
- Transportrisiko gen Null

[FR] Ces tableaux blancs sont :

- Transportables par voiture
- Simples à déplacer (même seul)
- Très simples à installer
- Sans angles
- Modulables à l'infinie
- Livrés très rapidement
- Très bien emballés (pas de problème lors du transport)

[ENG] The large format panels can be:

- Transported by car
- Moved by a single person
- Taken up in an elevator
- Installed by non-specialized personnel
- No edges
- Unlimited
- Short delivery deadline
- 0 transport incidents



¿Cómo se monta?

How is it set up? / Wie erfolgt die Montage? / Comment l'installer?

[ESP] Su facilidad y sencillez de montaje son únicos. 3 sencillos pasos y unos pocos minutos bastan para completar su instalación.

[ENG] Very easy and simple to build. 3 easy steps, just a few minutes to complete the installation.

[DE] Einfach und schnell in 3 Schritten:

1. Bohren der Montagelöcher gem. Bohrschablone
2. Anbringen der Magnet-Halterungen
3. Aufsetzen der Tafelmodule und ggfs. Ausrichten

[FR] Très simple à installer. 3 étapes simples, juste quelques minutes pour faire l'installation complète.

VIDEO



SkinCERAMIC

(Pizarra modular vitrificada / Enamelled modular whiteboard
 Emailliert Whiteboard Modul / Tableau modulable vitrifié)

[ESP] Gracias a su nuevo acabado vitrificado, la SkinCERAMIC permite ser utilizada en los entornos más exigentes como escuelas, institutos y aulas de formación donde la escritura es continua. Su superficie realizada en chapa de acero vitrificado permite una escritura continua con un mantenimiento mínimo y con una máxima garantía.

[ENG] Thanks to its new vitrified finish, the SkinCERAMIC allows to be used in the most demanding environments such as schools, institutes, and training rooms... where writing is continuous. Its surface is made of vitrified steel sheet which allows a continuous writing with minimal maintenance and with a maximum guarantee.

[DE] Dank ihrer neuen emaillierten Ausführung eignet sich die Produktreihe SkinCERAMIC bestens für den Einsatz in besonders anspruchsvollen Umgebungen wie Schulen, Gymnasien, Ausbildungsräumen usw., in denen fortwährend geschrieben wird. Die Oberfläche aus emailliertem Stahlblech ermöglicht das fortwährende Beschreiben in Verbindung mit minimalem Wartungsaufwand und maximaler Garantie.

[FR] Grâce à sa nouvelle finition vitrifiée, SkinCERAMIC peut être utilisé dans les environnements les plus exigeants comme les écoles, les collèges, les salles de formation, etc. où l'écriture est constante. Sa surface en tôle d'acier vitrifié est idéale pour une écriture continue avec un entretien minimum et une garantie maximum.



Skinwhiteboard, unlimited whiteboard



- 25 años de garantía (sólo superficie - para uso diario)
- 25 years warranty (Surface only - For daily use)
- 25 Jahre Oberflächen-Garantie bei richtiger Anwendung
- 25 ans de garantie* (*seulement la surface- pour une usage journalier)

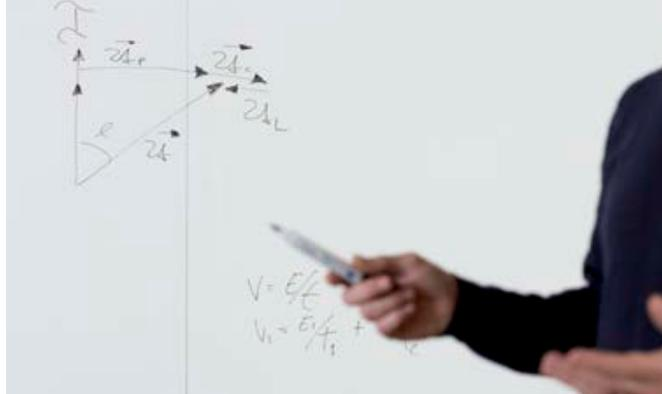

Sistema de sujeción que mantiene la superficie plana. Gracias a este sistema, se salvan fácilmente las irregularidades de la pared.

Subjection system that keeps the surface flat. Thanks to this system, the irregularities of the wall are easily overcome.





Incluye un rotulador
Marker included



Superficie para rotuladores de borrado en seco.
Dry wipe surface.
Trocken abwischbare Oberfläche.
Surface effaçable à sec.

ACABADOS / FINISHES / DEKORE / FINITIONS

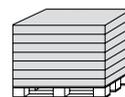
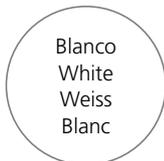

RD-6620CER - palet / pallet 30 u. - 85x125x145 cm
RD-6621CER - palet / pallet 30 u. - 110x160x165 cm

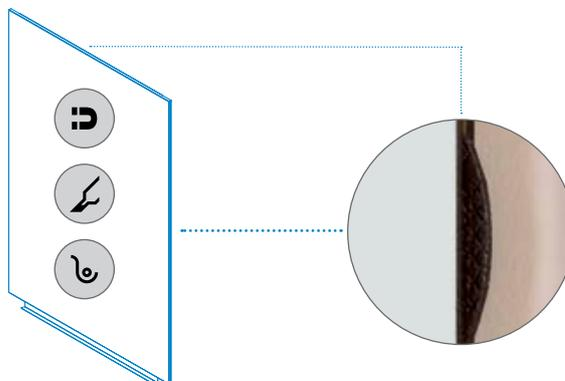
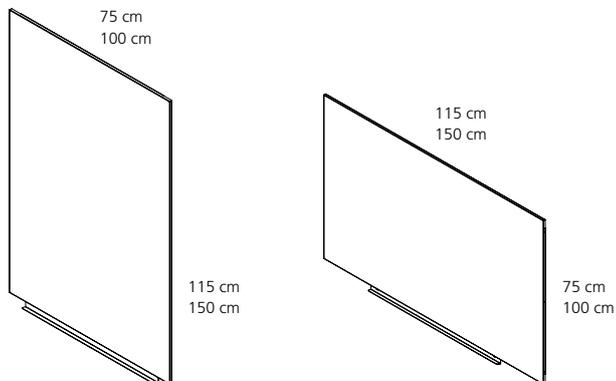

*Vitrificada / enamelled / emailliert / vitrifié

Recomendada para uso diario / recommended for daily use

Ref.	cm (embalaje / packaging)	kg / m ³ (embalaje / packaging)
RD-6620CER (75x115 cm)	136x96x3	17,30 kg / 0,040 m ³
RD-6621CER (100x150 cm)	170x121x3	24,00 kg / 0,062 m ³

Para otras medidas y acabados consultar a Rocada / For other sizes and finishes consult Rocada

SkinPRO (Pizarra modular / Modular whiteboard)

Protección adicional de la superficie • Additional surface protection Zusätzliche Oberflächen-Versiegelung • Surface de protection supplémentaire

[ESP] Gracias a su nuevo acabado especial con una protección adicional de la superficie realizado en material polimérico, la **SkinPRO** permite ser utilizada en los entornos más exigentes como escuelas, institutos y aulas de formación donde la escritura es continua. Su superficie permite una escritura continua con un mantenimiento mínimo y con una máxima garantía.

[ENG] Thanks to its new special finish with additional surface protection made of polymer material, the **SkinPRO** allows it to be used in the most demanding environments such as schools, institutes, and training rooms... where writing is continuous. Its surface allows a continuous writing with a minimum maintenance and with a maximum guarantee.

[DE] Dank ihrer neuen Sonderausführung mit einem zusätzlichen Polymer-Oberflächenschutz eignet sich die Reihe **SkinPRO** hervorragend für den Einsatz in besonders anspruchsvollen Umgebungen wie Schulen, Gymnasien, Ausbildungsräumen usw., in denen fortwährend geschrieben wird. Diese Oberfläche ermöglicht das fortwährende Beschreiben in Verbindung mit minimalem Wartungsaufwand und maximaler Garantie.

[FR] Grâce à sa nouvelle finition spéciale équipée d'une protection supplémentaire de la surface en matériau polymère, **SkinPRO** peut être utilisé dans les environnements les plus exigeants comme les écoles, les collèges, les salles de formation, etc. où l'écriture est constante. Sa surface est idéale pour une écriture continue avec un entretien minimum et une garantie maximum.

Skinwhiteboard, unlimited whiteboard

años de garantía
15
years guarantee

- 15 años de garantía (sólo superficie - para uso diario)
- 15 years warranty (Surface only - For daily use)
- 15 Jahre Oberflächen-Garantie bei richtiger Anwendung
- 15 ans de garantie* (*seulement la surface- pour une usage journalier)

NEW





Incluye un rotulador
Marker included



Superficie para rotuladores de borrado en seco.
Dry wipe surface.
Trocken abwischbare Oberfläche.
Surface effaçable à sec.

ACABADOS SUPERFICIE PRO / PRO SURFACE FINISHES
DEKORE OBERFLÄCHE PRO / FINITIONS SURFACE PRO

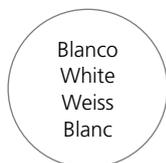

RD-6520PRO
RD-6521PRO



RD-6520PRO-9006
RD-6521PRO-9006

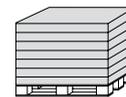

RD-6520PRO - palet / pallet 40 u. - 85x125x145 cm
RD-6521PRO - palet / pallet 40 u. - 110x160x165 cm

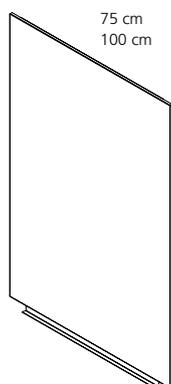

115 cm
150 cm

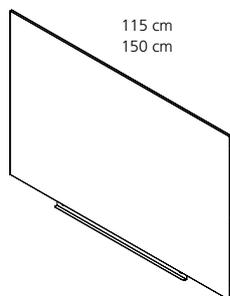

75 cm
100 cm

RD-6430R

Accesorio bloque de papel / Paper block accessory
20 hojas de 70gr / 20 sheets of 70gr

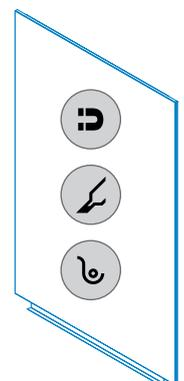
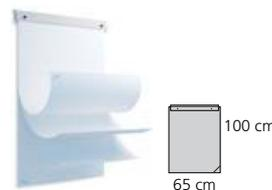

Lacada para rotulador / Lacquered for marker / Für Boardmarkeranwendungen beschichtet / Surface laqué pour des feutres effaçables.

Ref.	cm (embalaje / packaging)	kg / m ² (embalaje / packaging)
○ RD-6520PRO (75x115 cm)	124x84x3	8,15 kg / 0,031 m ³
○ RD-6521PRO (100x150 cm)	159x109x3	16,10 kg / 0,052 m ³
● RD-6520PRO-9006 (75x115 cm)	124x84x3	8,15 kg / 0,031 m ³
● RD-6521PRO-9006 (100x150 cm)	159x109x3	16,10 kg / 0,052 m ³

Para otras medidas y acabados consultar a Rocada / For other sizes and finishes consult Rocada

SkinCOLOUR

(Pizarra modular lacada / Lacquered modular whiteboard
Lackiertes Whiteboard Modul / Tableau modulable laqué)

[ESP] Ordena las tareas por colores, personaliza los departamentos de tu empresa, mejora la visualización de la información, etc. Los diferentes acabados totalmente compatibles con los rotuladores de borrado en seco combinan perfectamente con todo tipo de entornos y además darán un toque moderno y fresco a tu oficina.

[ENG] It arranges tasks by colour, personalizes company departments, improves visualization of information... The different finishes are fully compatible with dry-erase markers, blend in perfectly with any environment and also give a fresh and modern touch to your office.

[DE] Mit Farbe lässt sich viel ausdrücken und darstellen—unterschiedliche Bereiche oder Informationsschwerpunkte, Stimmungen oder einfach nur individueller Geschmack. Skin Color Schreiftafeln sind fast genauso funktionell wie die weißen Tafelmodule, bringen aber deutlich mehr Farbe in's (Büro)Leben.

[FR] Ces tableaux permettent d'organiser les tâches grâce aux différentes couleurs. Ils personnalisent l'entreprise tout en améliorant la visualisation des informations. Les différentes finitions sont compatibles avec les marqueurs effaçables, ils sont parfait pour donner une touche fraîche et moderne à votre bureau.

NEW

Skinwhiteboard, unlimited whiteboard

5 años de garantía
5 years warranty
5 Jahre Oberflächen-Garantie
5 ans de garantie

5 años de garantía (sólo superficie - para uso frecuente)
5 years warranty (Surface only - For common use)
5 Jahre Oberflächen-Garantie bei normaler Anwendung
5 ans de garantie* (*seulement la surface - pour un usage courant).

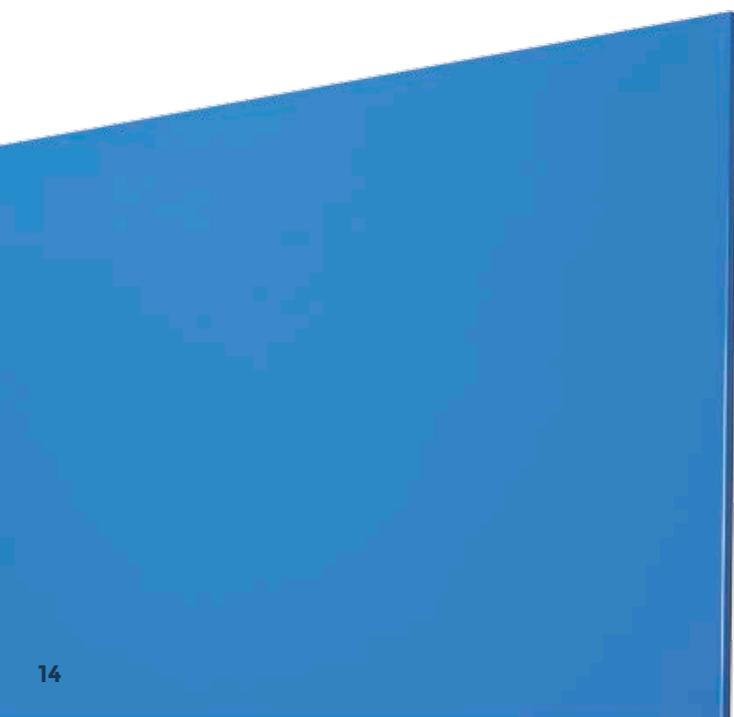

RD-6420R-630

Referencia medida
Size reference

Colour RAL



Incluye un rotulador
Marker included



Admite rotulador de tiza líquida. No limpiar con alcohol o productos abrasivos

Allows liquid chalk markers
Never clean it with alcohol or abrasive products.



ACABADOS ESTÁNDAR / STANDARD FINISHES
STANDARD-DEKORE / FINITIONS STANDARD

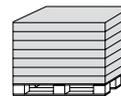
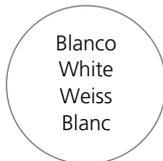

RD-6419R · RD-6420R · RD-6421R

RD-6419R - palet / pallet 50 u. - 80x120x145 cm
RD-6420R - palet / pallet 40 u. - 85x125x145 cm
RD-6421R - palet / pallet 40 u. - 110x160x165 cm

ACABADOS BAJO PEDIDO / UNDER REQUEST FINISHES / DEKORE AUF ANFRAGE / FINITIONS SUR DEMANDE

Plazo de preparación entre 5 y 10 días laborables.
Leadtime 5-10 working days.
Bearbeitungszeit zwischen 5 und 10 Werktagen.
Temps de préparation entre 5 et 10 jours ouvrables.

Skinwhiteboard, unlimited whiteboard

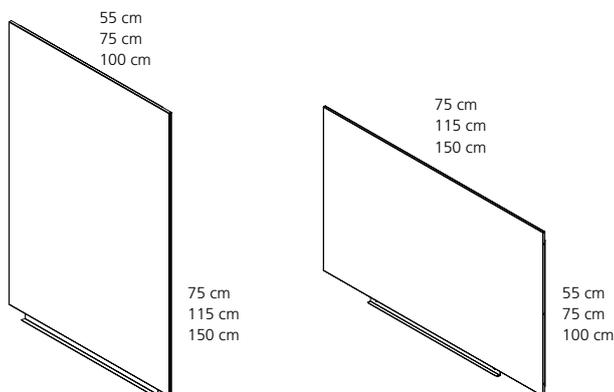

Superficie para rotuladores de borrado en seco.
No limpiar con alcohol o productos abrasivos.
Dry wipe surface. Never clean it with alcohol or abrasive products.
Bitte niemals mit reinem Alkohol reinigen und keine Tücher mit abrasiven Eigenschaften verwenden.
Surface effaçable à sec. Ne nettoyer jamais la surface avec de l'alcool ou un produit abrasif.

Lacada. Superficie borrado en seco. / Lacquered. Dry erase surface. / Lackierte Oberfläche für trocken abwischbare Beschriftungen. / Surface laquée effaçable à sec.

Ref.	cm (embalaje / packaging)	kg / m ³ (embalaje / packaging)
○ RD-6419R (55x75 cm)	83x63x3	4,40 kg / 0,016 m ³
○ RD-6420R (75x115 cm)	124x84x3	8,15 kg / 0,031 m ³
○ RD-6421R (100x150 cm)	159x109x3	16,10 kg / 0,052 m ³

Para otras medidas y acabados consultar a Rocada / For other sizes and finishes consult Rocada

SkinSHAPE

SkinIDEA / SkinCLOUD / SkinTALK (Lacado / Lacquered / Lackierte / Laquée)

[ESP] Los diferentes acabados totalmente compatibles con los rotuladores de borrado en seco y las nuevas formas darán un toque moderno y fresco a tu oficina.

[ENG] The different finishes are fully compatible with dry-wipe markers and the new SkinSHAPE range will bring a fresh and inspirational touch to your office.

[DE] Die Auswahl an Formen und Farben bringt Frische und Inspiration in Ihr Büro oder Ihre Meeting-Zone. Dabei sind die in jeweils zwei Größen erhältlichen Symbol-Tafeln wie die Standardtafeln mit Boardmarkern beschriftbar und magnethaftend. Ausnahme: die schwarz pulverbeschichtete Ausführung ist nur mit Kreide oder Kreidemarkern beschriftbar. Zu jedem Shape-Modul gehört ein Ablageboard mit fixierter Montageposition.

[FR] Les nouveaux designs de la gamme SkinSHAPE rendent les idées et la communication plus vivantes.

NEW

Skinwhiteboard, unlimited whiteboard

5 años de garantía
5 years warranty
5 Jahre Oberflächen-Garantie
5 ans de garantie*

5 años de garantía (sólo superficie - para uso frecuente)
5 years warranty (Surface only - For common use)
5 Jahre Oberflächen-Garantie bei normaler Anwendung
5 ans de garantie* (*seulement la surface - pour un usage courant).

Medidas / Sizes (cm)

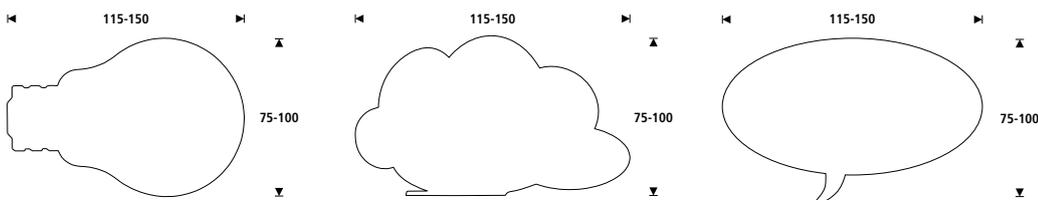

Lacada para rotulador / Lacquered for marker / Für Boardmarkeranwendungen beschichtet / Surface laqué pour des feutres effaçables.

IDEA	CLOUD	TALK	cm (producto / product)	cm (embalaje / packaging)	kg / m ³ (embalaje / packaging)
RD-6460	RD-6450	RD-6440	75x115	124x84x3	8,15 kg / 0,030 m ³
RD-6461	RD-6451	RD-6441	100x150	159x109x3	16,10 kg / 0,052 m ³

Para otras medidas y acabados consultar a Rocada / For other sizes and finishes consult Rocada



Incluye un rotulador
Marker included



Admite rotulador de tiza líquida.
No limpiar con alcohol o productos
abrasivos

Allows liquid chalk markers
Never clean it with alcohol or abrasive
products.

ACABADOS BAJO PEDIDO / UNDER REQUEST FINISHES / DEKORE AUF ANFRAGE / FINITIONS SUR DEMANDE

RAL 9010	RAL 630	RAL 230	RAL 490	RAL 1013	RAL 1015	RAL 1016
RAL 1023	RAL 2002	RAL 2008	RAL 3002	RAL 3012	RAL 3014	RAL 3015
RAL 4005	RAL 5017	RAL 5021	RAL 5024	RAL 6018	RAL 6019	RAL 6027
RAL 7030	RAL 7033	RAL 7035	RAL 7038	RAL 7039	Plazo de preparación entre 5 y 10 días laborables. Leadtime 5-10 working days. Bearbeitungszeit zwischen 5 und 10 Werktagen. Temps de préparation entre 5 et 10 jours ouvrables.	

Lacada. Superficie borrado en seco. / Lacquered. Dry erase surface. / Lackierte Oberfläche für trocken abwischbare Beschriftungen. / Surface laquée effaçable à sec.

Superficie para rotuladores de borrado en seco.
No limpiar con alcohol o productos abrasivos.

Dry wipe surface. Never clean it with alcohol or abrasive products.

Bitte niemals mit reinem Alkohol reinigen und keine Tücher mit abrasiven
Eigenschaften verwenden.

Surface effaçable à sec. Ne nettoyer jamais la surface avec de l'alcool ou un
produit abrasif.



RD-6440-230

Referencia medida
Size reference

Colour RAL

SkinAGILE

(Pizarra modular lacada / Lacquered modular whiteboard
Lackiertes Whiteboard Modul / Tableau modulable laqué)

[ESP] SkinAGILE permite aplicar diferentes metodologías para el desarrollo de proyectos que precisan de rapidez y flexibilidad para adaptarse a condiciones cambiantes del sector o mercado.

[ENG] SkinAGILE allows applying different methodologies for the development of projects that require speed and flexibility to adapt to changing conditions in the sector or market.

[DE] SkinAGILE erlaubt die Anwendung verschiedener Methoden zur Ausführung von Projekten, bei denen Schnelligkeit und Flexibilität gefordert sind, um sich an die wechselnden Bedingungen des jeweiligen Sektors oder Markts anpassen zu können.

[FR] SkinAGILE permet d'appliquer différentes méthodologies pour le développement de projets requérant rapidité et flexibilité afin de s'adapter aux conditions changeantes du secteur ou du marché.

NEW

Skinwhiteboard, unlimited whiteboard

TO DO

DOING

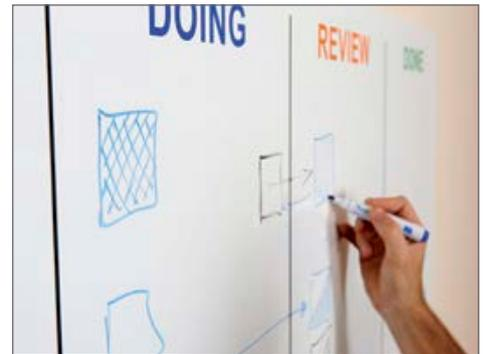

Superficie para rotuladores de borrado en seco.
No limpiar con alcohol o productos abrasivos.

Dry wipe surface. Never clean it with alcohol or abrasive products.

Bitte niemals mit reinem Alkohol reinigen und keine Tücher mit abrasiven Eigenschaften verwenden.

Surface effaçable à sec. Ne nettoyer jamais la surface avec de l'alcool ou un produit abrasif.



RD-S4323MX
(20x10cm)



RD-S4324MX
(12,5x12,5cm)



Skinny Notes incluida / included



Incluye un rotulador
Marker included

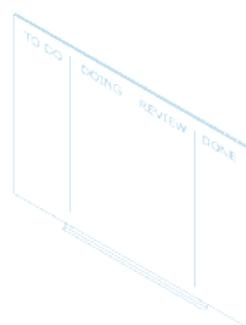
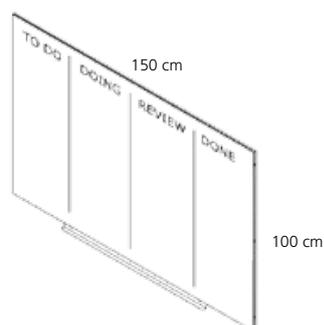

Lacada para rotulador / Lacquered for marker / Für Boardmarkeranwendungen beschichtet / Surface laqué pour des feutres effaçables.

Ref.	cm (embalaje / packaging)	kg / m ³ (embalaje / packaging)
RD-6421AG (100x150 cm)	159x109x3	16,10 kg / 0,052 m ³

Para otras medidas y acabados consultar a Rocada / For other sizes and finishes consult Rocada

SkinCUBE

(Lacado / Lacquered / Lackierte / Laquée)

[ESP] El intercambio de información requiere soluciones de gestión visual (visual management) que se actualizan tan rápido y eficientemente como sea posible. SkinCUBE nace con esta idea. Realizado con una estructura interior en DM y panelado con chapa de acero lacada.

[ENG] The exchange of information requires visual management solutions that are updated as quickly and as efficiently as possible. SkinCUBE was born with this idea. Made with MDF interior structure and paneling of lacquered steel sheet.

[DE] Der Informationsaustausch macht Lösungen im Bereich Visual Management erforderlich, die sich möglichst schnell und wirksam aktualisieren. Genau auf dieser Idee basiert SkinCUBE. Gefertigt mit einer MDF-Platte als Innenstruktur sowie einer Täfelung aus lackiertem Stahlblech.

[FR] L'échange d'informations exige des solutions de gestion visuelle (visual management) capables d'être mises à jour aussi rapidement et efficacement que possible. SkinCUBE est né de cette idée. Il comporte une structure intérieure en DM et en revêtement en tôle d'acier laqué.

NEW

Skinwhiteboard, unlimited whiteboard





Superficie para rotuladores de borrado en seco.
No limpiar con alcohol o productos abrasivos.

Dry wipe surface. Never clean it with alcohol or abrasive products.

Bitte niemals mit reinem Alkohol reinigen und keine Tücher mit abrasiven Eigenschaften verwenden.

Surface effaçable à sec. Ne nettoyer jamais la surface avec de l'alcool ou un produit abrasif.



Ruedas con sistema de freno
Wheels with brake system

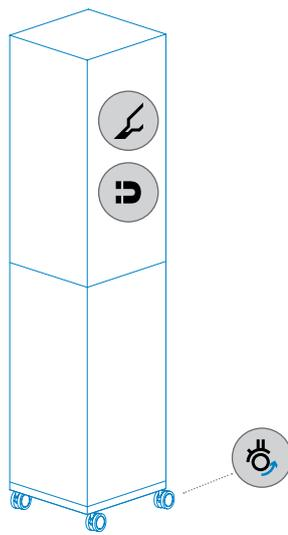
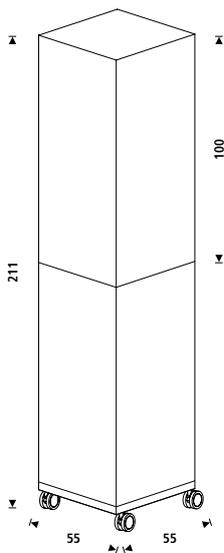

Lacada para rotulador / Lacquered for marker / Für Boardmarkeranwendungen beschichtet / Surface laqué pour des feutres effaçables.

Ref.	cm (embalaje / packaging)	kg / m ³ (embalaje / packaging)
RD-6876S4	130x120x80	81,45 kg / 1,248 m ³

Para otras medidas y acabados consultar a Rocada / For other sizes and finishes consult Rocada

SkinMATT

(Pizarra modular lacada / Lacquered modular whiteboard
Lackiertes Whiteboard Modul / Tableau modulable laqué)

[ESP] Gracias a su nuevo acabado mate, la **SkinMATT** permite ser utilizada como pantalla de proyección. Su acabado final mate totalmente compatible con los rotuladores de borrado en seco también permite ser utilizado como pizarra de pared.

[ENG] Thanks to its new matte finish, **SkinMATT** can be used as a projection screen. Its matte is fully compatible with dry-wipe markers. Can also be used as a wall whiteboard.

[DE] Die Oberflächenausführung **SkinMATT** ist speziell als Projektionsfläche konzipiert und bietet sich insbesondere für die Verwendung von Kurzstanzbeamern an. Magnethaftend und begrenzt auch für die Verwendung von Boardmarkern geeignet.

[FR] Grâce à sa nouvelle finition mate, **SkinMATT** peut être utilisé comme support de projection. Son revêtement mat est entièrement compatible avec les marqueurs effaçables à sec. Peut également être utilisé comme un tableau blanc classique.

Skinwhiteboard, unlimited whiteboard

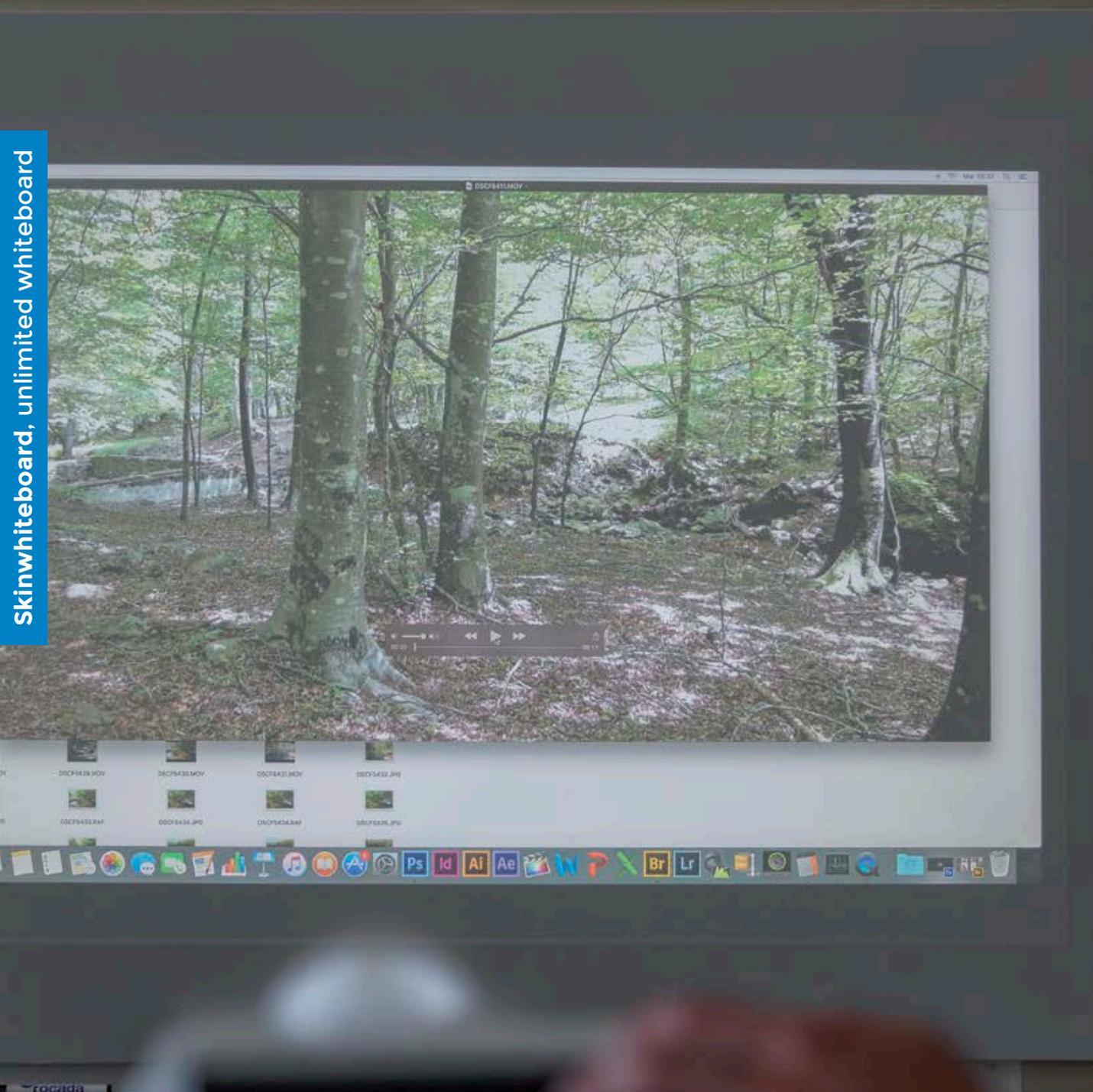



Superficie para rotuladores de borrado en seco.
No limpiar con alcohol o productos abrasivos.

Dry wipe surface. Never clean it with alcohol or abrasive products.

Bitte niemals mit reinem Alkohol reinigen und keine Tücher mit abrasiven Eigenschaften verwenden.

Surface effaçable à sec. Ne nettoyer jamais la surface avec de l'alcool ou un produit abrasif.

La pizarra SkinMATT se adapta perfectamente al formato de proyección 4:3, pudiendo crear una imagen de tamaño un 25% más grande que con las pizarras mate convencionales cuya altura máxima es tan sólo de 120cm.

The SkinMATT fits perfectly into the 4:3 projection format, creating an image size by 25% bigger than the conventional matt whiteboards whose maximum height is only 120cm.

Ejemplo / Example

Imagen con SkinMATT
SkinMATT image

Imagen con PIZARRA CONVENCIONAL
CONVENTIONAL MATT WHITEBOARD Image

200 x 150

200 x 120



RD-S4319V19

Kit de limpieza y accesorios Skin
Cleaning kit and accessories

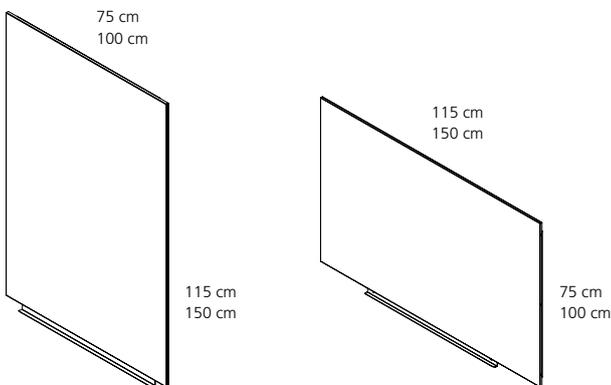

RD-6430R

Accesorio bloque de papel / Paper block accessory
20 hojas de 70gr / 20 sheets of 70gr

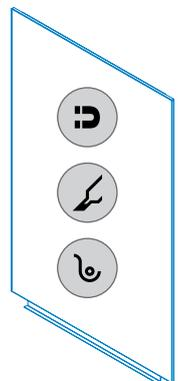
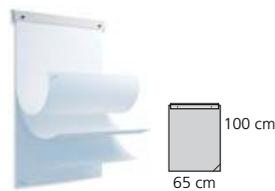

Lacada para rotulador / Lacquered for marker / Für Boardmarkeranwendungen beschichtet / Surface laqué pour des feutres effaçables.

Ref.	cm (embalaje / packaging)	kg / m ³ (embalaje / packaging)
RD-6420MATT (75 x 115 cm)	124x84x3	8,15 kg / 0,031 m ³
RD-6421MATT (100 x 150 cm)	159x109x3	16,10 kg / 0,052 m ³
RD-6430R (65x90cm) opcional / optional	87x8x8	1,6 kg / 0,005 m ³

Para otras medidas y acabados consultar a Rocada / For other sizes and finishes consult Rocada

SkinMUSIC

(Pizarra modular lacada / Lacquered modular whiteboard
Lackiertes Whiteboard Modul / Tableau modulable laqué)

[ESP] Gracias a su nuevo acabado pentagrama y a la modularidad del sistema Skin, convierten a la SkinMUSIC en una de las mejores herramientas para el estudio y la creación de todo tipo de música. Su acabado con pentagrama es totalmente compatible con los rotuladores de borrado en seco.

[ENG] Thanks to its new music notation layout and to the Skin system flexibility, SkinMUSIC becomes one of the best tools for studying and creating all kinds of music. Its unique finish is fully compatible with dry-erase markers.

[DE] Praktisch für den theoretischen Musik-Unterricht oder die klassische Komponistentätigkeit. Die mit Notenlinien bedruckten Tafelmodule können beliebig aneinandergesetzt werden oder auch mit weißen Tafelmodulen kombiniert werden. Das Modulformat 115x75cm ist mit 5 Notensystemen, das Modulformat 150x100 mit 7 Notensystemen bedruckt.

[FR] Grâce à ce nouveau design et au système Skin Flexibilité, le SkinMUSIC devient l'un des meilleurs outils pour étudier et créer toutes sortes de musique. Sa finition unique est entièrement compatible avec les marqueurs effaçables à sec.



Skinwhiteboard, unlimited whiteboard



Superficie para rotuladores de borrado en seco.
No limpiar con alcohol o productos abrasivos.

Dry wipe surface. Never clean it with alcohol or abrasive products.

Bitte niemals mit reinem Alkohol reinigen und keine Tücher mit abrasiven Eigenschaften verwenden.

Surface effaçable à sec. Ne nettoyer jamais la surface avec de l'alcool ou un produit abrasif.

RD-6421RMH
150x100 cm

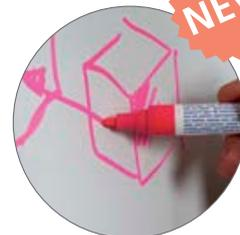

Admite rotulador de tiza líquida. No limpiar con alcohol o productos abrasivos

Allows liquid chalk markers
Never clean it with alcohol or abrasive products.



Incluye un rotulador
Marker included



I4319
Imanes · Magnets



RD-S4300V19
Borrador · Eraser

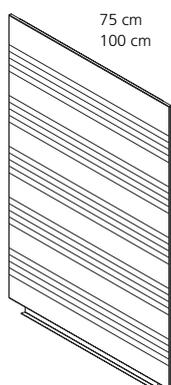

115 cm
150 cm

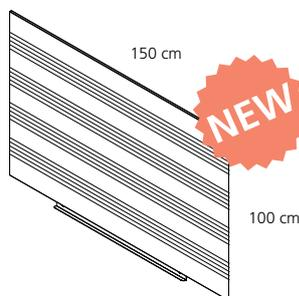

RD-6430R
Accesorio bloque de papel / Paper block accessory
20 hojas de 70gr / 20 sheets of 70gr

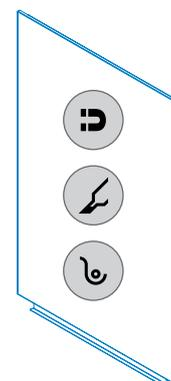
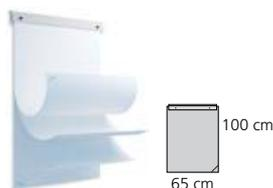

Lacada para rotulador / Lacquered for marker / Für Boardmarkeranwendungen beschichtet / Surface laqué pour des feutres effaçables.

Ref.	cm (embalaje / packaging)	kg / m ³ (embalaje / packaging)
RD-6420RM (75 x 115 cm)	124x84x3	8,15 kg / 0,031 m ³
RD-6421RM (100 x 150 cm)	159x109x3	16,10 kg / 0,052 m ³
RD-6421RMH (150 x 100 cm) horizontal	159x109x3	16,10 kg / 0,052 m ³
RD-6430R (65x90cm) opcional / optional	87x8x8	1,6 kg / 0,005 m ³

Para otras medidas y acabados consultar a Rocada / For other sizes and finishes consult Rocada

SkinLIQUID

(Pizarra modular lacada / Lacquered modular whiteboard
Lackiertes Whiteboard Modul / Tableau modulable laqué)

[ESP] Gracias a su nuevo acabado negro, la SkinLIQUID permite ser utilizada como pizarra para tiza líquida ideal para restaurantes, bares y comercios en general. Su excelente modularidad permite crear todo tipo de configuraciones acorde a las necesidades actuales y futuras en la oficina y en casa.

[ENG] Thanks to its new black finish, the SkinLIQUID can be used as a whiteboard for liquid chalk. This is ideal for restaurants, bars and shops in general. Its excellent modularity enables creating all kinds of configurations according to current and future needs in the office and at home.

[DE] Dank seiner neuen Ausführung in schwarz kann SkinLIQUID als Tafel für flüssige Kreidestifte verwendet werden und eignet sich somit ideal für Restaurants, Bars und Geschäfte verschiedenster Art. Dank seiner hervorragenden Modularität können alle möglichen Konfigurationen erstellt werden, dies entsprechend den aktuellen und zukünftigen Anforderungen im Büro oder daheim

[FR] Avec sa nouvelle finition noire, SkinLIQUID peut être utilisé comme tableau à craie liquide : il est idéal pour les restaurants, les bars et plus généralement tout type de commerces. Son excellente modularité permet de créer tout type de configurations en fonction des besoins actuels et futurs, aussi bien au bureau qu'à la maison.

NEW

Skinwhiteboard, unlimited whiteboard





Admite rotulador de tiza líquida. No limpiar con alcohol o productos abrasivos

Allows liquid chalk markers
Never clean it with alcohol or abrasive products.

x1 x1 x1 x1
RD-S5050MX
Rotuladores de tiza líquida
Liquid chalk markers



Skinwhiteboard, unlimited whiteboard

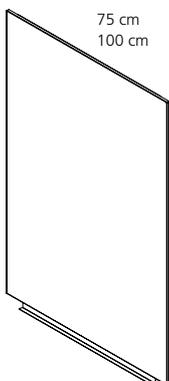

115 cm
150 cm

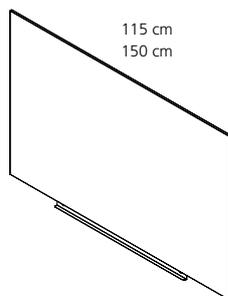

75 cm
100 cm

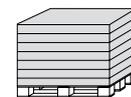
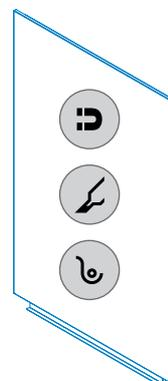

RD-6820V19 - palet / pallet 40 u. - 85x125x145 cm
RD-6821V19 - palet / pallet 40 u. - 110x160x165 cm

Lacada para rotulador / Lacquered for marker / Für Boardmarkeranwendungen beschichtet / Surface laqué pour des feutres effaçables.

Ref.	cm (embalaje / packaging)	kg / m ³ (embalaje / packaging)
RD-6820V19 (75x115 cm)	124x84x3	8,15 kg / 0,031 m ³
RD-6821V19 (100x150 cm)	159x109x3	16,10 kg / 0,052 m ³

Para otras medidas y acabados consultar a Rocada / For other sizes and finishes consult Rocada

SkinPINBOARD

[ESP] Panel modular tapizado sin marco para generar combinaciones y presentaciones que cubran tus necesidades. SkinPINBOARD es sencilla de colocar ahorrando tiempo y dinero.

[ENG] Upholstered modular panel without frame to generate combinations and presentations that meet your needs. SkinPINBOARD is simple to place. Saves time and money.

[DE] Gepolsterte modulare Tafel ohne Rahmen, um Kombinationen und Präsentationen zu erstellen, die Ihre Anforderungen und Bedürfnisse erfüllen. SkinPINBOARD ist einfach anzubringen. Spart Zeit und Geld.

[FR] Panneau modulaire tapissé sans cadre afin de donner lieu à des combinaisons et à des présentations parfaitement adaptées à vos besoins. SkinPINBOARD facile à installer. Économisez du temps et de l'argent.



Skinwhiteboard, unlimited whiteboard

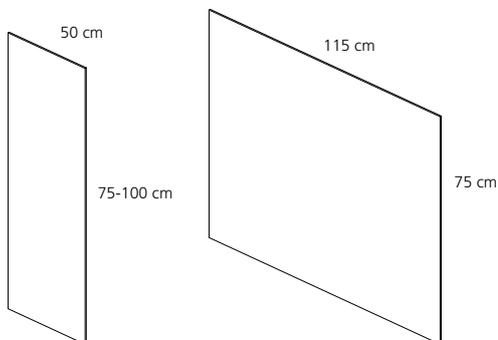
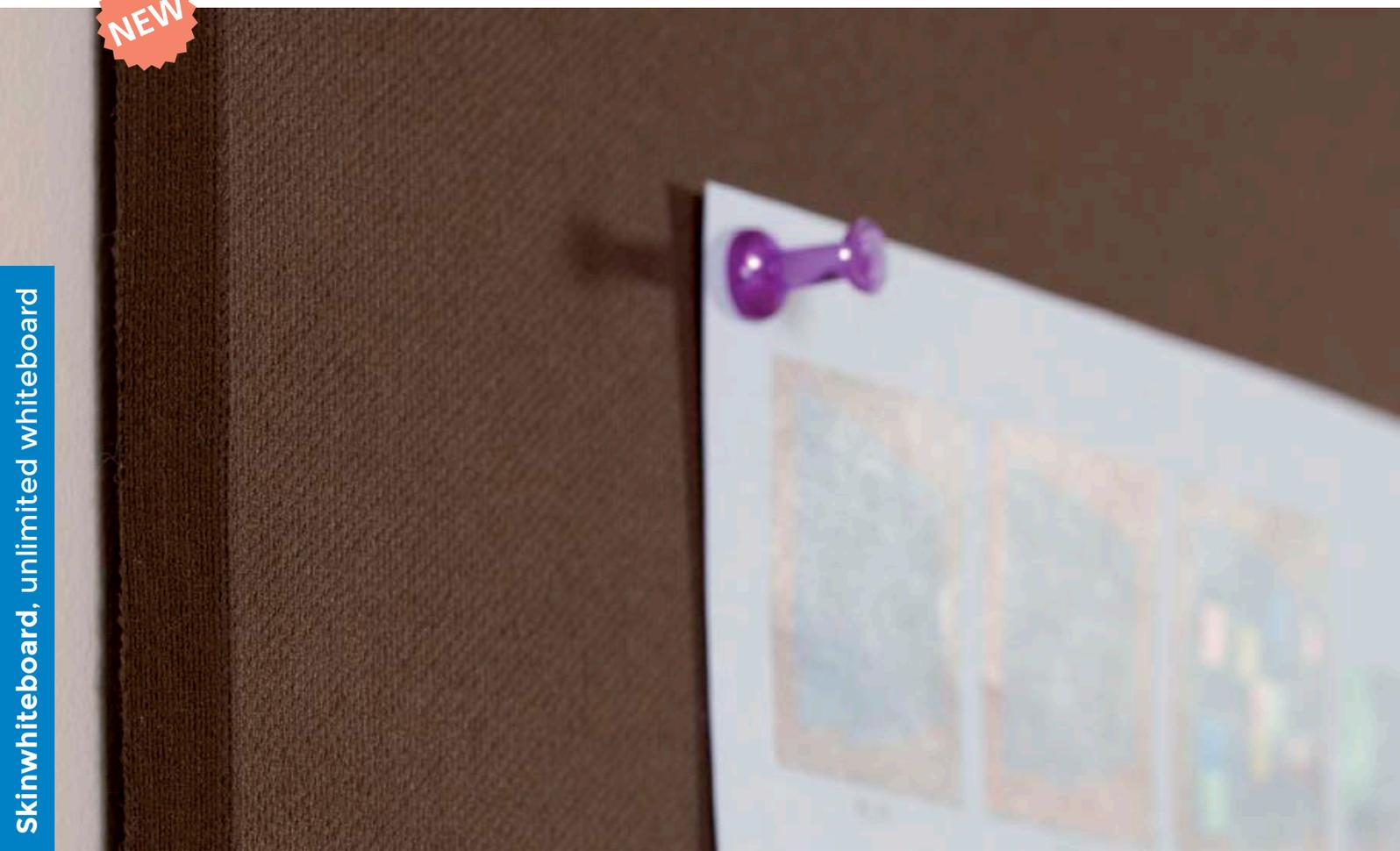

Ref.	cm (embalaje / packaging)	kg / m ³ (embalaje / packaging)
RD-6249 (50x75cm)	83x63x3	2,00 kg / 0,016 m ³
RD-6248 (50x100cm)	109x59x3	3,00 kg / 0,019 m ³
RD-6250 (75x115cm)	124x84x3	3,00 kg / 0,031 m ³

Para otras medidas y acabados consultar a Rocada / For other sizes and finishes consult Rocada



ACABADOS ESTÁNDAR / STANDARD FINISHES / STANDARD-DEKORE / FINITIONS STANDARD

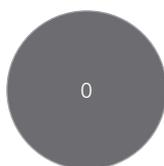

0



2



510



512



518



523

RD-6248-2

Referencia
medida
Size reference

Color / Colour

Skinwhiteboard, unlimited whiteboard

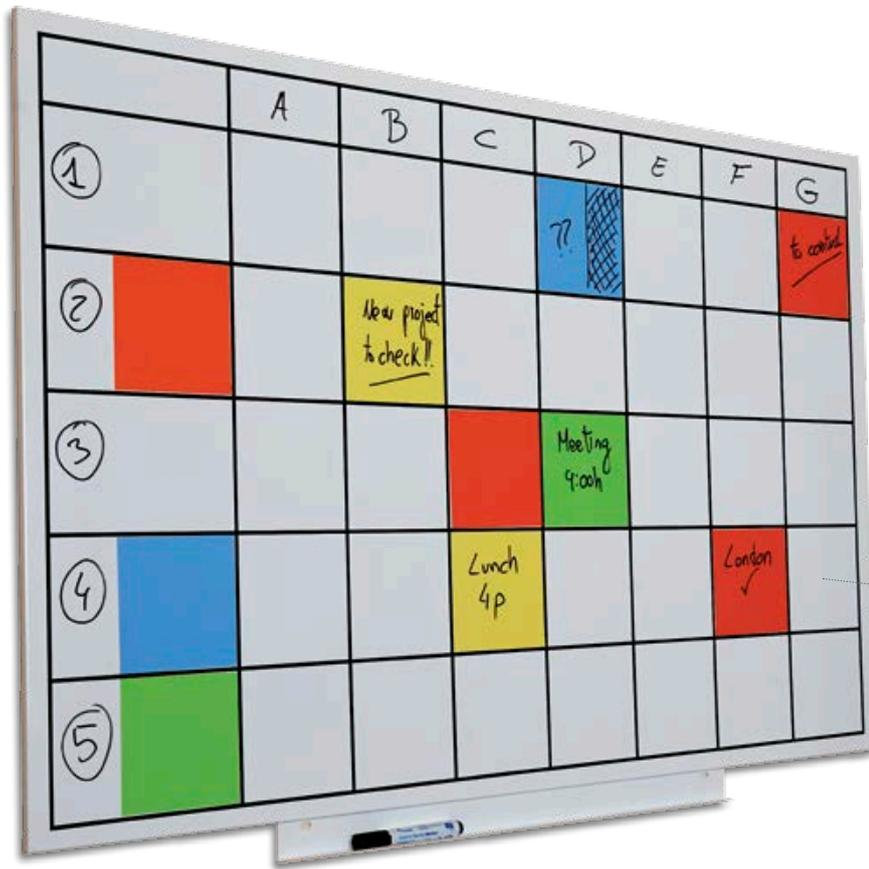

Superficie para rotuladores de borrado en seco.
No limpiar con alcohol o productos abrasivos.

Dry wipe surface. Never clean it with alcohol or abrasive products.

Bitte niemals mit reinem Alkohol reinigen und keine Tücher mit abrasiven Eigenschaften verwenden.

Surface effaçable à sec. Ne nettoyer jamais la surface avec de l'alcool ou un produit abrasif.



RD-S4323MX
(20x10cm)



RD-S4324MX
(12,5x12,5cm)



Skinny Notes incluida / included



Incluye un rotulador
Marker included

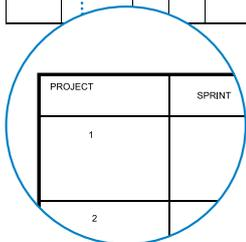
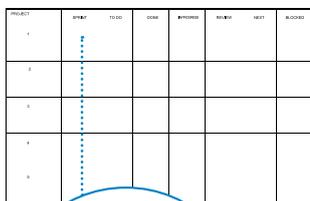

Plantilla adhesiva / Adhesive template

Rocada			
MONDAY	MONTAG	LUNDI	LUNES
TUESDAY	DIENSTAG	MARDI	MARTES
WEDNESDAY	MITTWOCH	MERCREDI	MERCOLES
THURSDAY	DONNERSTAG	JEUDI	JUEVES
FRIDAY	FREITAG	VENDREDI	VIERNES
SATURDAY	SAMSTAG	SAMEDI	SABADO
SUNDAY	SONNTAG	DIMANCHE	DOMINGO
WEEK	WOCHE	SEMAINE	SEMANA
DAY	TAG	JOUR	DIA
1	2	3	4
5	6	7	8
PROJECT	TO DO	PRIO	SPRINT
TASK	TO DO	PRIO	SPRINT
PROJECT	DONE	BLOCKED	INPROGRESS
TASK	DONE	BLOCKED	INPROGRESS
PRODUCT	STORY	NEXT	SPRINT
BACKLOG	STORY	NEXT	BACKLOG
PRODUCT	IN TEST	REVIEW	SPRINT
BACKLOG	IN TEST	REVIEW	BACKLOG

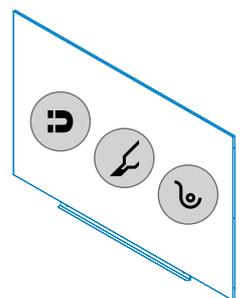
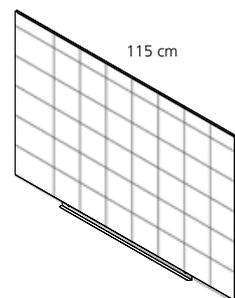

Lacada para rotulador / Lacquered for marker / Für Boardmarkeranwendungen beschichtet / Surface laqué pour des feutres effaçables.

Ref.	cm (embalaje / packaging)	kg / m ³ (embalaje / packaging)
RD-6420YP (75 x 115 cm)	124x84x3	8,15 kg / 0,031 m ³
RD-6420UP (75 x 115 cm)	124x84x3	8,15 kg / 0,031 m ³

Para otras medidas y acabados consultar a Rocada / For other sizes and finishes consult Rocada

SkinCLOCK

(Pizarra modular lacada / Lacquered modular whiteboard
Lackiertes Whiteboard Modul / Tableau modulable laqué)

[ESP] La SkinCLOCK le ayudará a planificar y organizar todo tipo de tareas. Su acabado es totalmente compatible con los rotuladores de borrado en seco. Incluye calendario y reloj analógico de serie.

[ENG] The SkinCLOCK will help you plan and organize all kinds of tasks. The finish is fully compatible with dry-wipe markers. It includes a standard analogue clock.

[DE] Das praktische Organisationsmittel für eine schnelle Grobübersicht kurzfristiger Termine. Mit integrierter, batteriebetriebener Analog-Uhr. Monatskalendarium, Uhrzeit und Notizfläche machen diese Tafelversion zu einem praktischen Helfer für den Büroalltag.

[FR] Le SkinCLOCK vous aidera à planifier et organiser votre journée. La finition est entièrement compatible avec les marqueurs effaçable à sec. Il comprend une horloge analogique standard.

Skinwhiteboard, unlimited whiteboard

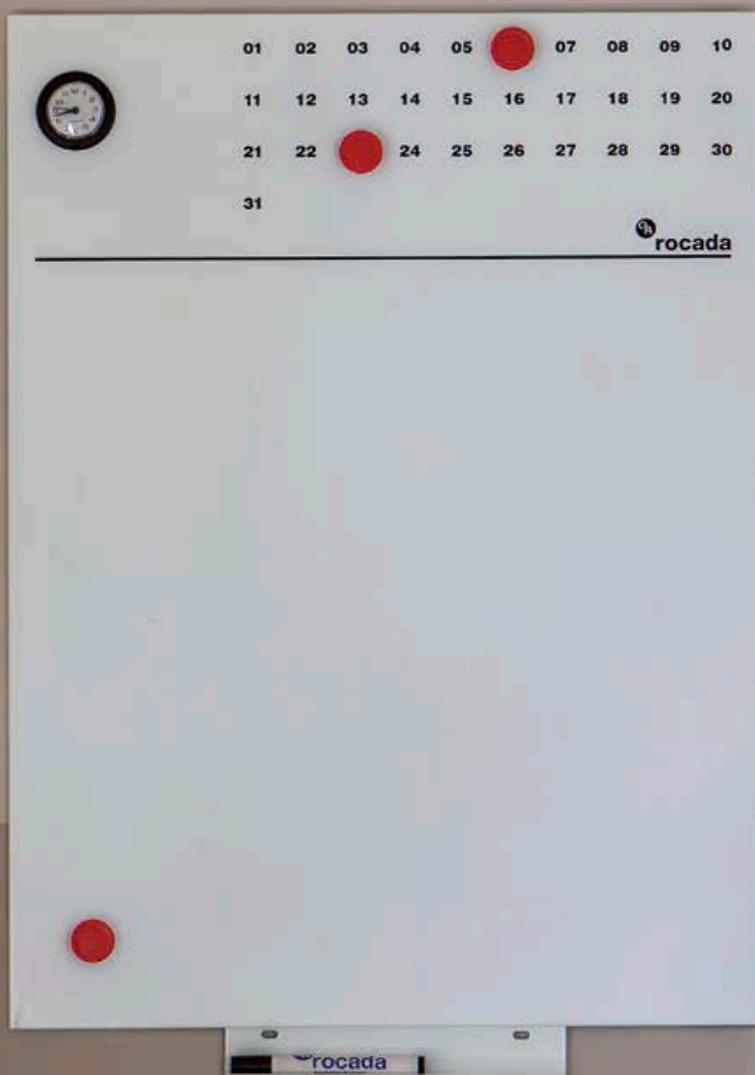

Pila no incluida
Battery not included

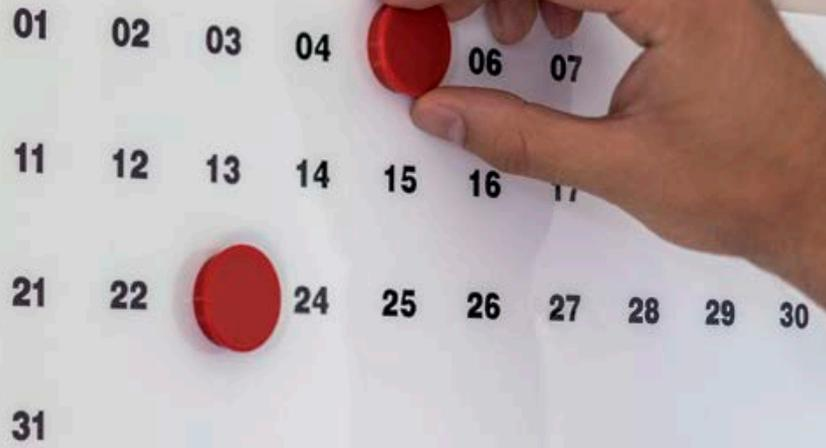

Superficie para rotuladores de borrado en seco.
No limpiar con alcohol o productos abrasivos.

Dry wipe surface. Never clean it with alcohol or abrasive products.

Bitte niemals mit reinem Alkohol reinigen und keine Tücher mit abrasiven Eigenschaften verwenden.

Surface effaçable à sec. Ne nettoyer jamais la surface avec de l'alcool ou un produit abrasif.



RD-S4319V19

Kit de limpieza y accesorios Skin
Cleaning kit and accessories

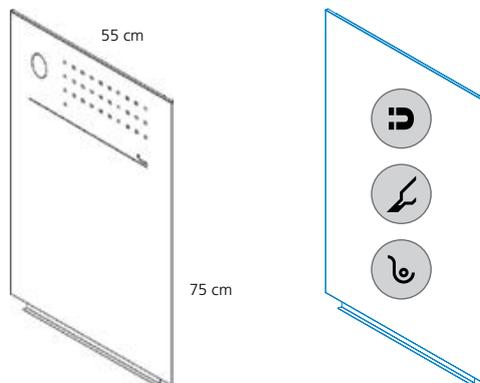

Lacada para rotulador / Lacquered for marker / Für Boardmarkeranwendungen beschichtet / Surface laqué pour des feutres effaçables.

Ref.	cm (embalaje / packaging)	kg / m ³ (embalaje / packaging)
RD-6419CL (55 x 75 cm)	84x64x3	4,5 kg / 0,017 m ³

Para otras medidas y acabados consultar a Rocada / For other sizes and finishes consult Rocada

SkinSUPPORT

Soporte móvil de doble cara para Skin

Double sided mobile support for Skin · Mobiles, beidseitig bestückbares Tafelstativ für Skin Whiteboard
Support mobile double face pour Skin

[ESP] Resistente soporte de metal con un diseño simple para Skin**WHITEBOARD** 100x150 cm (permite Skin en todos sus acabados). Sistema de fijaciones mediante imanes según el sistema patentado Skin. El soporte permite fijar 1 unidad Skin a cada lado dando lugar a una pizarra de dos caras. No incluye la pizarra.

[ENG] Sturdy metal mobile support with simple design for Skin**WHITEBOARD** 100x150cm (allows all Skin finishes). Fixing system through magnets following the Skin patented system. The support allows fixing 1 unit of Skin to each side, achieving double side boards. Skin board not included.

[DE] Mit dem Skin Tafelstativ lassen sich Skin Whiteboards auch mobil einsetzen. Dabei führt die Gestellkonstruktion das puristisch-elegante Design der Tafelmodule fort. Das Montageprinzip bleibt unverändert, die Anbringung erfolgt mittels starker Haftmagnete; diese sind im Lieferumfang des Stativs enthalten. Das Stativ kann ein- oder beidseitig bestückt werden, die gewünschten Tafelmodule (nur 100x150cm) sind separat zu bestellen. Mit der Flipchartpapierklemme als Zusatzausstattung lässt sich der Anwendungsbereich erweitern. Dank des modularen Charakters können Sie sich ein mobiles und preiswertes Multifunktionsmöbel zusammenstellen, z.B.: Seite A : Skin Whiteboard Pro 6521 plus Flipcharthalterung RD 6430, Seite B Skin Projektionsboard RD 6421Matt. Also Whiteboard, Flipchart und Projektionstafel in einem. Und das Dank großer, feststellbarer Laufrollen mobil!

[FR] Support mobile en métal robuste avec un design simple compatible avec le Skin**WHITEBOARD** 100x150cm. Système de fixation simple grâce à des aimants qui suivent notre système breveté. Le support permet de fixer 2 tableaux (dos à dos). Tableaux non inclus.





El soporte no es compatible con la Skin Ceramic y Skin Shape
The support doesn't allow installation of the Skin Ceramic and Skin Shape

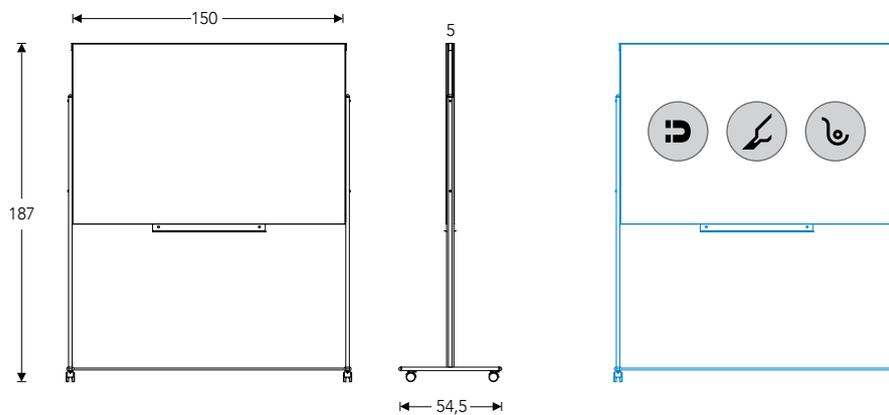

Skinwhiteboard, unlimited whiteboard



RD-6430R
Accesorio bloque de papel / Paper block accessory
20 hojas de 70gr / 20 sheets of 70gr

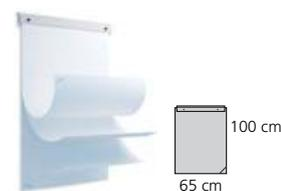

Ref.	cm (embalaje / packaging)	kg / m ³ (embalaje / packaging)
RD-6875 (150 x 100 cm) (solo soporte / only support)	159x100x7	17,10 kg / 0,111 m ³
RD-6430R (65x90cm)	87x8x8	1,6 kg / 0,005 m ³

Para otras medidas y acabados consultar a Rocada / For other sizes and finishes consult Rocada



Skinwhiteboard, unlimited whiteboard



Skin no incluida, solo protector
Skin not included, only protector

▲
¿Cómo se monta?
How is it set up?
Wie erfolgt die Montage?
Comment l'installer ?

Medidas / Sizes (cm)

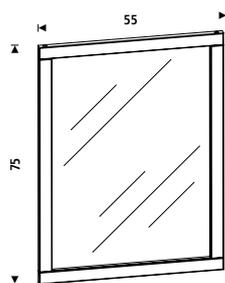

Marco madera 3.8x1.9cm
Wood frame with magnetic system
(3.8x1.9cm)
Metacrilato 4mm de espesor
Methacrylate of 4mm thickness

Ref.	cm (embalaje / packaging)	kg / m ³ (embalaje / packaging)
RD-6419PRT (55x75cm) (4xA4)	84x64x3	3,60 kg / 0.016 m ³

Para otras medidas y acabados consultar a Rocada / For other sizes and finishes consult Rocada

SkinBLOCK

[ESP] SkinBLOCK es el accesorio perfecto que se adapta a cualquier producto del Skin program. Incluye sistema de fijación y bloque de papel de 20 hojas de 70gr. Su fácil aplicación y fácil recambio agiliza la comunicación en todo momento.

[ENG] SkinBLOCK is the perfect accessory that adapts to any product of the Skin program. Includes fixing system and block of paper of 20 sheets of 70gr. Its easy application and easy replacement facilitate communication at all times.

[DE] SkinBLOCK ist das ideale Zubehör, das sich an jedes Produkt vom Skin Program anpasst. Einschließlich Befestigungssystem und Papierblock mit 20 Blättern und 70 Gramm Gewicht. Seine einfache Anwendung und der problemlose Austausch erleichtern die Kommunikation

[FR] SkinBLOCK est l'accessoire idéal qui s'adapte à n'importe quel produit du Skin program. Il inclut un système de fixation et un bloc de papier de 20 feuilles de 70 g. Application facile, simplicité de remplacement : il optimise la communication à tout moment.





RD-6430R



No apto para Skin Ceramic ni Skin Shape
Not suitable for Skin Ceramic nor Skin Shape

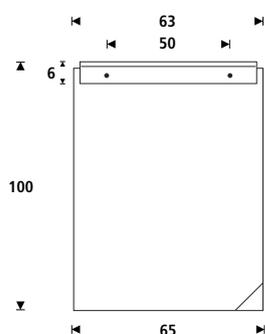

20 hojas de 70gr
20 sheets of 70gr

Ref.	cm (embalaje / packaging)	kg / m ³ (embalaje / packaging)
RD-6430R (65x90cm)	87x8x8	1,6 kg / 0,005 m ³

Para otras medidas y acabados consultar a Rocada / For other sizes and finishes consult Rocada

Skinwhiteboard, unlimited whiteboard

SkinnyNOTES

[ESP] Notas informativas removibles sin adhesivo. Permite la escritura en ambas caras con todo tipo de rotulador. 400 hojas, 100 hojas por color.

[ENG] Removable non-adhesive informative notes. Allows writing on both sides with any kind of marker. 400 sheets, 100 sheets per colour

[DE] Entfernbare Info-Notizen ohne Klebstoff. Ermöglicht das beidseitige Beschreiben mit jeglicher Art von Stift oder Marker. 400 Blätter, 100 Blätter pro Farbe

[FR] Notes d'information amovibles sans adhésif. Il est possible d'écrire sur les deux faces avec tout type de marqueur. 400 feuilles, 100 feuilles par couleur

NEW

Skinwhiteboard, unlimited whiteboard

Notas con carga estática
Glue-free static notes





RD-S4323MX
(20x10cm)
Pack 4u

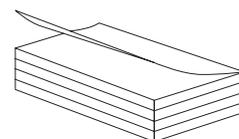

RD-S4324MX
(12,5x12,5cm)
Pack 4u

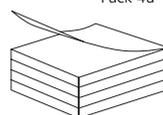

Parte trasera admite utilizar rotulador de borrado en seco
Dry erase markers allows to be used on the backside

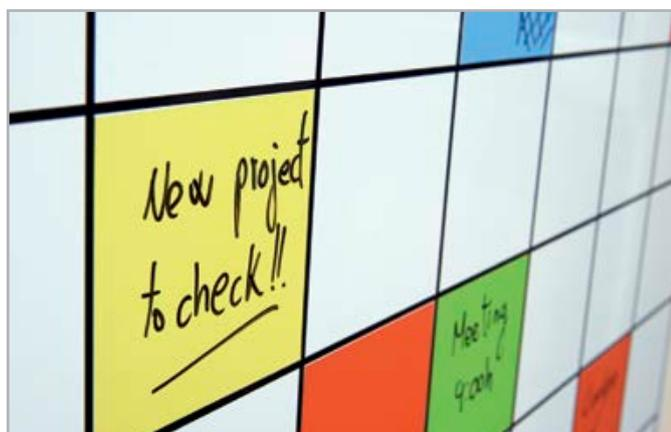

Ref.	Medidas / size	cm (embalaje / packaging)	kg / m ³ (embalaje / packaging)	Hojas / sheets
RD-S4323MX (20x10cm)	20x10 cm	20x10x3	0,30 kg / 0,001 m ³	400 (100 / color)
RD-S4324MX (12,5x12,5cm)	12,5x12,5 cm	12,5x12,5x3	0,20 kg / 0,001 m ³	400 (100 / color)

SkinMAP

(Pizarra modular / Modular whiteboard)

[ESP] La SkinMAP es una pizarra especialmente preparada para ilustrar y trabajar entorno a los mapas. Dispone de una área generosa para todo tipo de anotaciones, fijación de imanes y otros accesorios magnéticos. El acabado de la zona de trabajo es totalmente compatible con los rotuladores de borrado en seco.

[ENG] The SkinMAP is a whiteboard specifically prepared to illustrate and work around maps. It has a generous area for all types of annotations, fixing magnets and other magnetic accessories. The whiteboard is fully compatible with dry erase markers.

[DE] SkinMAP ist eine Tafel, die speziell für die Illustration und die Arbeit in Verbindung mit Stadtplänen und Landkarten vorgesehen ist. Verfügt über einen umfangreichen Bereich für Anmerkungen, für die Anbringung von Magneten und von sonstigen magnetischen Zubehörteilen. Die Oberflächenausführung des Arbeitsbereichs ist für trocken abwischbare Boardmarker geeignet.

[FR] La SkinMAP est un tableau spécialement conçu pour l'illustration et le travail sur des plans. Il possède une zone généreuse pour tout type de notes, fixation aimantée et autres accessoires magnétiques. La finition de la zone de travail est entièrement compatible avec les marqueurs effaçables à sec.

NEW

Skinwhiteboard, unlimited whiteboard

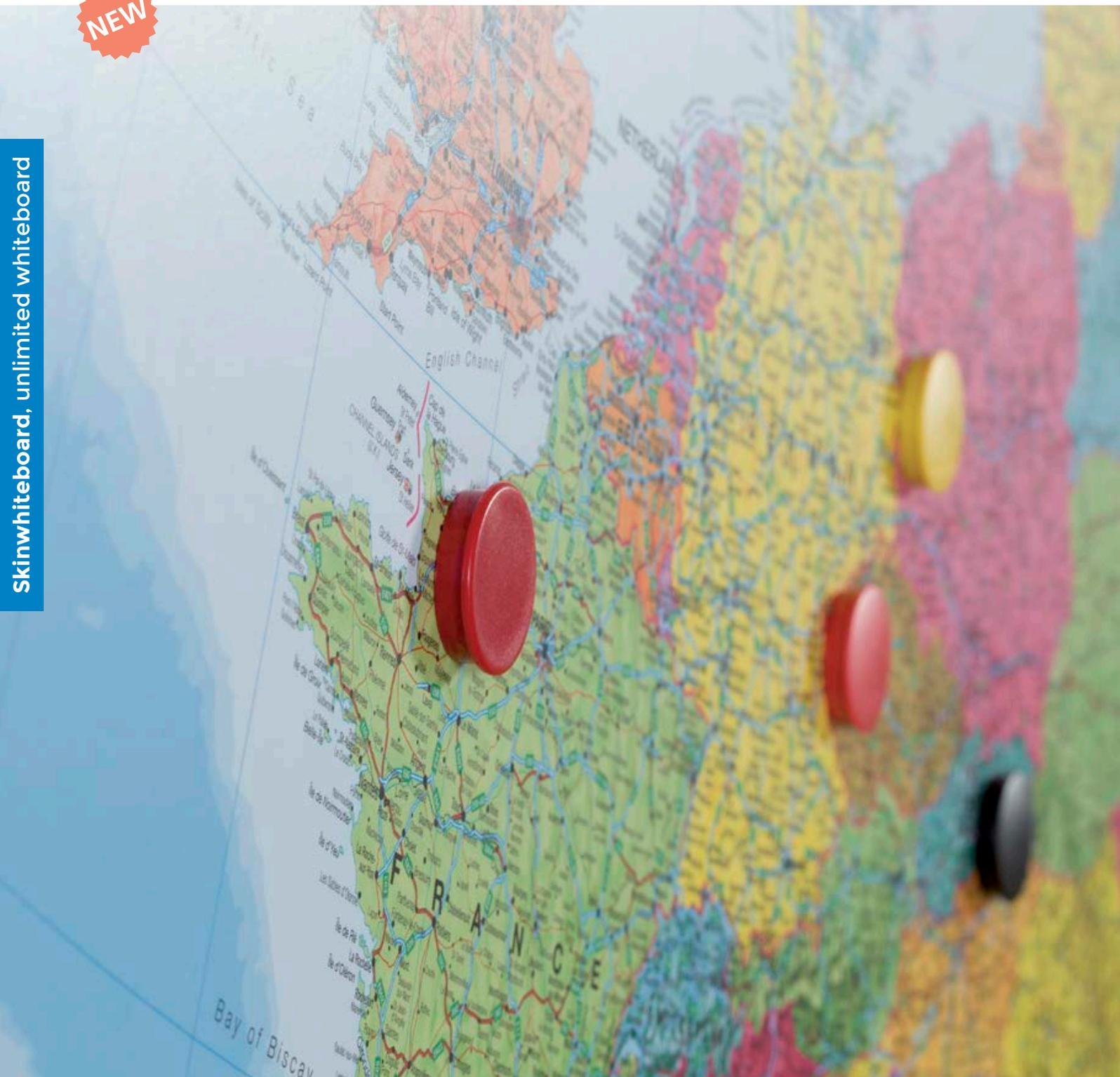

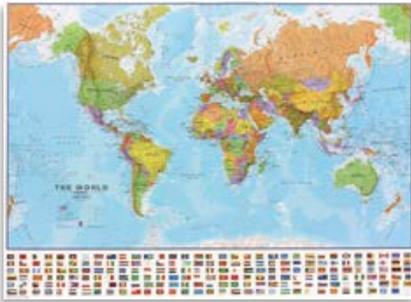

6421MAPWD
 Texto en inglés / Text in English



6421MAPUE
 Texto en inglés / Text in English



6421MAPSP
 Texto en español / Text in Spanish

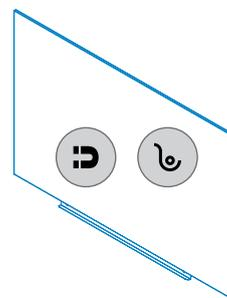
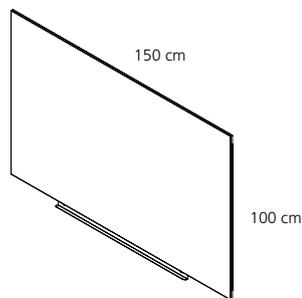

Ref.	cm (embalaje / packaging)	kg / m ³ (embalaje / packaging)
6421MAPWD World (150 x 100 cm)	159x109x3	16,10 kg / 0,052 m ³
6421MAPUE Europe (150 x 100 cm)	159x109x3	16,10 kg / 0,052 m ³
6421MAPSP Spain (150 x 100 cm)	159x109x3	16,10 kg / 0,052 m ³

PIZARRAS DE PARED

WHITEBOARDS • WANDSCHREIBTAFELN • TABLEAUX MURAUX

[ESP] Pizarra metálica y magnética (*) con marco de aluminio anodizado. Superficie blanca apta para escritura con rotuladores de borrado en seco. Incluye bandeja para rotuladores y accesorios para la fijación a pared. Viene montada.

[ENG] Board with anodised aluminium frame with suitable surface for writing with dry-wipe markers. Includes marker tray and wall fixing accessories. Supplied assembled.

[DE] Standard - Whiteboard-Serie. Alurahmen mit grauem Eckverbinder. Ablageleiste und Montagematerial im Lieferumfang enthalten.

[FR] Tableau avec cadre en aluminium anodisé et surface pour écriture au marqueur effaçable à sec. Livré avec auget porte-marqueurs et kit de fixation murale. Livré monté.



Superficie para rotuladores de borrado en seco.
No limpiar con alcohol o productos abrasivos.

Dry wipe surface. Never clean it with alcohol or abrasive products.

Bitte niemals mit reinem Alkohol reinigen und keine Tücher mit abrasiven Eigenschaften verwenden.

Surface effaçable à sec. Ne nettoyer jamais la surface avec de l'alcool ou un produit abrasif.





Compatible con soportes móviles RD-6870PLUS, RD-8090, RD-6870 y RD-6877
Compatible with mobile supports RD-6870PLUS, RD-8090, RD-6870 and RD-6877



RD-S4319V19

Kit de limpieza y accesorios Skin
Cleaning kit and accessories



45 / 60 / 90 /
100 / 120 cm

60/90/120/150/180/200/240 cm

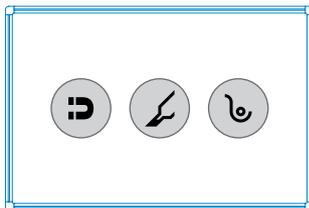

Pizarras vitrificadas
Enamelled boards
Emailliert Tafeln
Tableaux vitrifié

***Vitrificada / enamelled / emailliert / vitrifié**

Recomendada para uso diario / recommended for daily use

Ref.	cm (embalaje / packaging)	kg / m ³ (embalaje / packaging)
RD-6500 (60x45 cm)	72x47x3	2,45 kg / 0,007 m ³
RD-6502 (90x60 cm)	103x62x3	4,60 kg / 0,016 m ³
RD-6504 (120x90 cm)	133x92x3	8,81 kg / 0,031 m ³
RD-6507 (150x120 cm)	165x126x3	14,33 kg / 0,052 m ³
RD-6508 (180x120 cm)	200x126x3	17,05 kg / 0,063 m ³
RD-6511 (200x120 cm)	220x126x3	16,40 kg / 0,069 m ³
RD-6512 (240x120 cm)	259x126x3	22,47 kg / 0,082 m ³

Para otras medidas consultar Skin Program / For other sizes consult Skin Program

***Lacada / lacquered / lackiert / laqué**

Recomendada para uso frecuente / recommended for common use

Ref.	cm (embalaje / packaging)	kg / m ³ (embalaje / packaging)
RD-6400 (60x45 cm)	72x47x3	2,10 kg / 0,008 m ³
RD-6402 (90x60 cm)	103x62x3	3,91 kg / 0,016 m ³
RD-6404 (120x90 cm)	133x92x3	7,44 kg / 0,031 m ³
RD-6406 (150x100 cm)	165x106x3	11,50 kg / 0,043 m ³
RD-6407 (150x120 cm)	165x126x3	12,05 kg / 0,052 m ³
RD-6408 (180x120 cm)	200x126x3	14,30 kg / 0,063 m ³
RD-6410 (200x100 cm)	220x105x3	13,28 kg / 0,058 m ³
RD-6411 (200x120 cm)	220x126x3	14,30 kg / 0,069 m ³
RD-6412 (240x120 cm)	259x126x3	18,82 kg / 0,082 m ³

Para otras medidas consultar Skin Program / For other sizes consult Skin Program

Melamina / melamine / melamine / melaminé

Recomendada para uso normal / recommended for normal use

Ref.	cm (embalaje / packaging)	kg / m ³ (embalaje / packaging)
RD-6300 (60x45 cm)	72x47x3	2,48 kg / 0,007 m ³
RD-6302 (90x60 cm)	103x62x3	4,67 kg / 0,016 m ³
RD-6304 (120x90 cm)	133x92x3	8,95 kg / 0,306 m ³
RD-6308 (180x120 cm)	200x126x3	17,33 kg / 0,063 m ³
RD-6311 (200x120 cm)	220x126x3	16,90 kg / 0,069 m ³
RD-6312 (240x120 cm)	259x126x3	22,30 kg / 0,082 m ³

PIZARRA VITRIFICADA MATE

MATT ENAMELLED BOARD • MATT-EMAILLIERTE SCHREIBTAFEL
TABLEAU VITRIFIÉ MAT

[ESP] Pizarra vitrificada metálica y magnética con marco de aluminio anodizado. Superficie apta para la escritura con rotuladores de borrado en seco. El acabado mate de la superficie está especialmente pensado para proyecciones audiovisuales e interactivas. Incluye bandeja para rotuladores y accesorios para la fijación a pared. Viene montada.

[ENG] Enamelled whiteboard with anodised aluminium frame with surface suitable for writing with dry-wipe markers. Includes marker tray and wall fixing accessories. The matt finish of the surface is designed especially for projection of audiovisuals, interactives, etc. Supplied assembled

[DE] Emaillierte Wandtafel mit matter Oberfläche, speziell für die Zweit-Verwendung als Projektionsfläche konzipiert. Rahmen aus eloxiertem Aluminium. Inklusive Markerablage und Zubehör für die Wandmontage. Zum Beschreiben mit trocken abwischbaren Boardmarkern geeignet.

[FR] Tableau mural vitrifié avec cadre en aluminium anodisé et surface apte pour l'écriture au marqueur effaçable à sec. Livré avec auget porte-marqueurs et kit pour fixation murale. La finition mate de la surface est spécialement conçue pour la projection d'audio-visuels, interactifs, ... Livré monté.

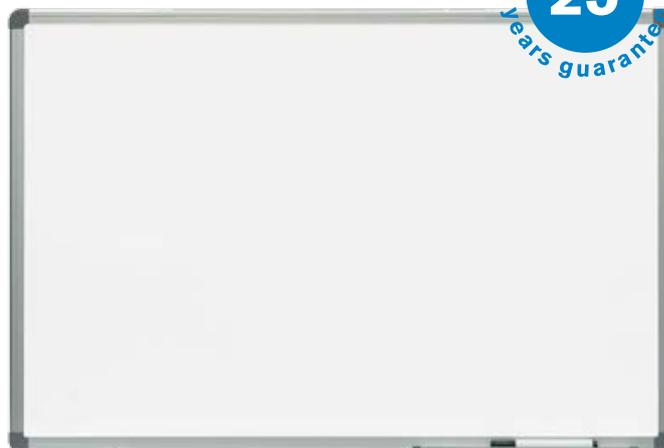

RD-S4040MX*12

Rotuladores
Board markers
Tafelschreiber
Marqueurs



Superficie para rotuladores de borrado en seco.
No limpiar con alcohol o productos abrasivos.
Dry wipe surface. Never clean it with alcohol or abrasive products.
Bitte niemals mit reinem Alkohol reinigen und keine Tücher mit abrasiven Eigenschaften verwenden.
Surface effaçable à sec. Ne nettoyer jamais la surface avec de l'alcool ou un produit abrasif.



100/150/200/240 cm

120 cm

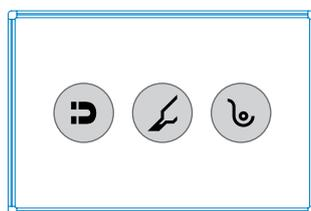

Compatible con soportes móviles RD-6870PLUS, RD-8090, RD-6870 y RD-6877
Compatible with mobile supports RD-6870PLUS, RD-8090, RD-6870 and RD-6877

Vitrificada / enamelled / emailliert / vitrifié

Recomendada para uso diario / recommended for daily use

Ref.	cm (embalaje / packaging)	kg / m ³ (embalaje / packaging)
RD-6505MAT (100x120)	126x120x3	11,50 / 0,038 m ³
RD-6507MAT (150x120)	165x126x3	14,33 / 0,052 m ³
RD-6511MAT (200x120)	220x126x3	16,40 / 0,069 m ³
RD-6512MAT (240x120)	259x126x3	22,40 / 0,082 m ³

Para otras medidas consultar Skin Program / For other sizes consult Skin Program

PIZARRA DOBLE CARA

DOUBLE-SIDED BOARD • DOPPELSEITIGE TAFEL • TABLEAU À DOUBLE FACE

[ESP] Pizarra de doble cara metálica y magnética con marco de aluminio anodizado. Superficie blanca apta para escritura con rotuladores de borrado en seco. Viene montada.

[ENG] Double-sided board with anodised aluminium frame with surface suitable for writing with dry-wipe markers. Supplied assembled.

[DE] Doppelseitige Tafel mit Rahmen aus eloxiertem Aluminium. Zum Beschreiben mit trocken abwischbaren Markern. Wird montiert geliefert.

[FR] Tableau à double face avec cadre en aluminium anodisé et surface apte pour l'écriture au marqueur effaçable à sec. Livré monté.

Sólo para superficie vitrificada
Only for enamelled surface

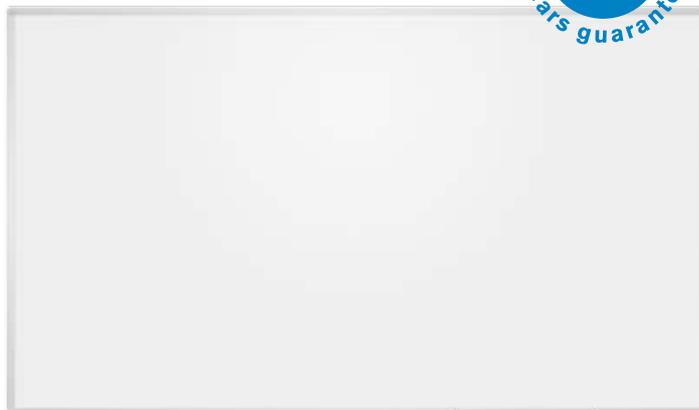

Superficie para rotuladores de borrado en seco.
No limpiar con alcohol o productos abrasivos.
Dry wipe surface. Never clean it with alcohol or abrasive products.
Bitte niemals mit reinem Alkohol reinigen und keine Tücher mit abrasiven Eigenschaften verwenden.
Surface effaçable à sec. Ne nettoyer jamais la surface avec de l'alcool ou un produit abrasif.



120/150/180/200 cm

90/120 cm

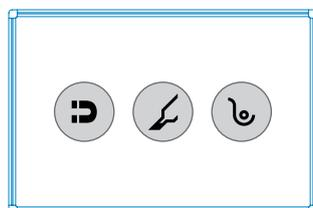

Compatible con soportes móviles RD-6870PLUS, RD-8090, RD-6870 y RD-6877
Compatible with mobile supports RD-6870PLUS, RD-8090, RD-6870 and RD-6877

Vitrificada / enamelled / emailiert / vitrifié

Recomendada para uso diario / recommended for daily use

Ref.	cm (embalaje / packaging)	kg / m ³ (embalaje / packaging)
RD-6854 (120x90 cm)	133x95x3	12,40 kg / 0,030 m ³
RD-6855 (150x120 cm)	165x126x3	17,30 kg / 0,052 m ³
RD-6856 (180x120 cm)	200x126x3	20,25 kg / 0,063 m ³
RD-6857 (200x120 cm)	220x126x3	22,50 kg / 0,069 m ³

Lacada / lacquered / lackiert / laqué

Recomendada para uso frecuente / recommended for common use

Ref.	cm (embalaje / packaging)	kg / m ³ (embalaje / packaging)
RD-6950 (120x90 cm)	133x95x3	11,50 kg / 0,030 m ³
RD-6951 (150x120 cm)	165x126x3	16,30 kg / 0,052 m ³
RD-6952 (180x 120 cm)	200x126x3	18,30 kg / 0,063 m ³
RD-6953 (200x120 cm)	220x126x3	20,34 kg / 0,069 m ³

PIZARRA PARED CRISTAL

GLASS WHITEBOARDS • GLAS-SCHREIBTAFEL • TABLEAU EN VERRE

[ESP] Pizarra de pared de cristal templado de 6 mm. Perfecta escritura y borrado gracias a su tratamiento superficial. Incorpora bandeja metálica. Viene montada.

[ENG] Tempered glass 6mm glassboard, with perfect writing and cleaning characteristics thanks to its finished treatment. Includes metal tray for board markers. Comes mounted.

[DE] Schreibtafel aus satiniertem, gehärtetem Glas, 6mm. Perfekte Schreib- und Reinigungseigenschaften aufgrund der geschlossenen Oberfläche. Inkl: Ablageleiste für Boardmarker.

[FR] Tableau en verre trempé de 6 mm. Écriture et effaçage parfaits grâce à son traitement en surface. Comprend un plateau métallique. Livré monté.

Sólo superficie
Only surface

años de garantía
25
years guarantee



Cristal pintado blanco
White painted glass

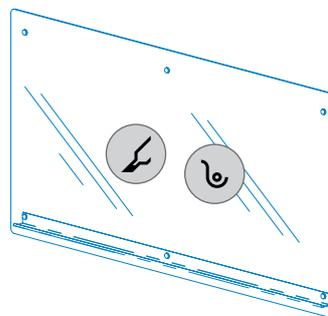
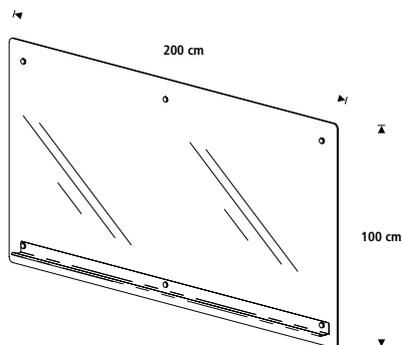
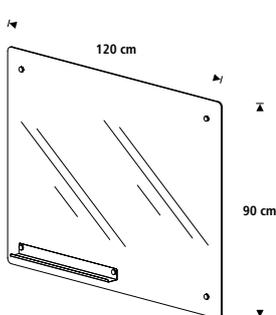

Incluye un rotulador
Marker included

Recomendada para uso diario / recommended for daily use

Ref.	cm (embalaje / packaging)	kg / m ³ (embalaje / packaging)
RD-6700 (120x90 cm)	125x95x6	15 kg / 0,071 m ³
RD-6701 (200x100 cm)	210x105x6	22 kg / 0,132 m ³

PIZARRA VITRIFICADA VERDE

GREEN ENAMELLED BOARD • EMAILLIERTE KREIDETAFEL • TABLEAU VITRIFIÉ VERT

[ESP] Pizarra vitrificada metálica y magnética de superficie color verde apta para escritura con rotuladores de tiza líquida o tiza. Marco de aluminio anodizado. Incluye bandeja para útiles de escritura y accesorios para la fijación a pared. Viene montada.

[ENG] Magnetic enamelled board with a green surface suitable for writing with liquid chalk markers and chalk, with anodised aluminium frame. Includes writing tool tray and wall fixing accessories. Supplied assembled.

[DE] Emaillierte Schreibtafel mit grüner, magnethaftender Oberfläche zum Beschreiben mit Kreide. Rahmen aus eloxiertem Aluminium. Inklusive Schreibgeräteablage und Zubehör für die Wandmontage. Für intensive Anwendungen geeignet.

[FR] Tableau vitrifié magnétique avec surface de couleur verte apte pour craie avec cadre en aluminium anodisé. Livré avec auget porte-accessoires d'écriture et kit pour fixation murale. Livré monté.

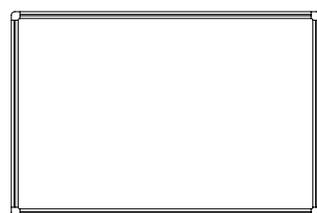
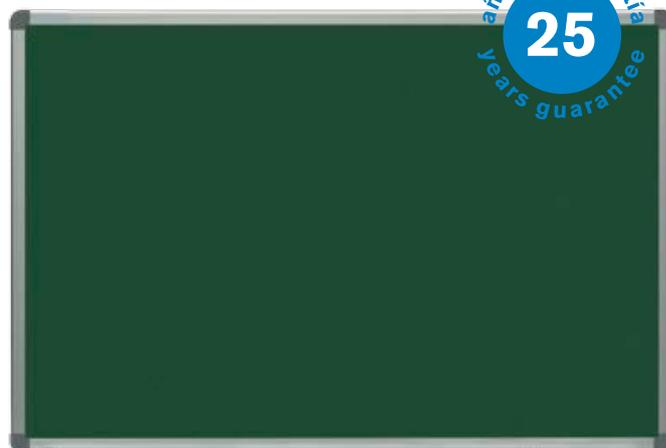

90/120 cm

120/150/180/200 cm

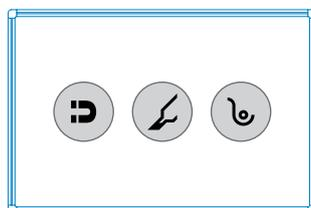

Compatible con soportes móviles RD-6870PLUS, RD-8090, RD-6870 y RD-6877
Compatible with mobile supports RD-6870PLUS, RD-8090, RD-6870 and RD-6877

Vitrificada / enamelled / emailliert / vitrifié

Recomendada para uso diario / recommended for daily use

Ref.	cm (embalaje / packaging)	kg / m ³ (embalaje / packaging)
RD-6507GRCH (150x120 cm)	165x126x3	14,30 / 0,052 m ³
RD-6508GRCH (180x120 cm)	200x94x3	17,00 / 0,063 m ³
RD-6511GRCH (200x120 cm)	200x126x3	20,50 / 0,069 m ³
RD-6512GRCH (240x120 cm)	260x126x3	22,50 / 0,082 m ³

PIZARRAS DE CORCHO

CORKBOARDS • KORKTAFELN • TABLEAUX EN LIÈGE

[ESP] Tablero de corcho con marco de aluminio anodizado. Corcho resistente y autorregenerable. Incluye accesorios para la fijación a la pared. Viene montado.

[ENG] Corkboard with anodised aluminium frame. Includes accessories for wall fixing. Comes assembled.

[DE] Korktafel mit Rahmen aus eloxiertem Aluminium. Inklusive Zubehör für die Wandmontage.

[FR] Tableau en liège avec cadre en aluminium anodisé. Livré avec kit pour fixation murale. Livré monté.



Compatible con soportes móviles RD-6870PLUS, RD-8090, RD-6870 y RD-6877
Compatible with mobile supports RD-6870PLUS, RD-8090, RD-6870 and RD-6877



60/90/120/150/180/240 cm

45/60/90/100/120 cm

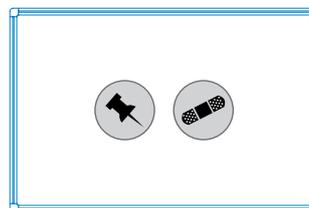

Ref.	cm (embalaje / packaging)	kg / m ³ (embalaje / packaging)
RD-6200 (60x45 cm)	72x47x3	1,40 kg / 0,007 m ³
RD-6202 (90x60 cm)	103x62x3	2,77 kg / 0,016 m ³
RD-6204 (120x90 cm)	133x92x3	5,40 kg / 0,031 m ³
RD-6206 (150x100 cm)	165x105x3	7,72 kg / 0,043 m ³
RD-6208 (180x120 cm)	200x126x3	10,85 kg / 0,063 m ³
RD-6212 (240x120 cm)	259x126x3	14,21 kg / 0,082 m ³

TABLERO TAPIZADO

UPHOLSTERED BOARD • STOFF-PINNTAFEL • PANNEAU TAPISSÉ

[ESP] Tablero tapizado con marco de aluminio anodizado. Suave superficie de fieltro. Incluye accesorios para la fijación a la pared.

[ENG] Upholstered board with anodised aluminium frame. Includes accessories for wall fixing.

[DE] Stoff-Pinntafel. Rahmen aus eloxiertem Aluminium. Inklusive Zubehör für die Wandmontage.

[FR] Panneau tapissé avec cadre en aluminium anodisé. Livré avec kit pour fixation murale.

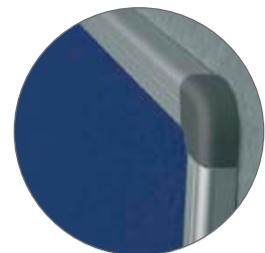

Compatible con soportes móviles RD-6870PLUS, RD-8090, RD-6870 y RD-6877
Compatible with mobile supports RD-6870PLUS, RD-8090, RD-6870 and RD-6877

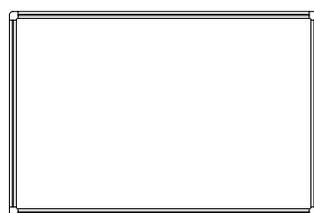

45/60/90/120 cm

60/90/120/180 cm

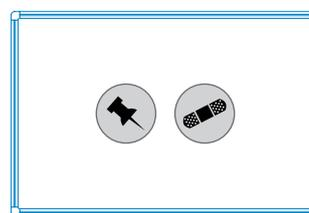

Ref.	cm (embalaje / packaging)	kg / m ³ (embalaje / packaging)
RD-6600 (60x45 cm)	72x47x3	1,60 kg / 0,007 m ³
RD-6602 (90x60 cm)	103x62x3	2,90 kg / 0,016 m ³
RD-6604 (120x90 cm)	133x92x3	5,40 kg / 0,031 m ³
RD-6608 (180x120 cm)	200x126x3	10,85 kg / 0,063 m ³

Para otras medidas consultar Skin Program / For other sizes consult Skin Program

PIZARRA TRÍPTICA VITRIFICADA

TRIPTIC ENAMELLED WHITEBOARD • KLAPPTAFEL
TABLEAU TRIPTYQUE EN VITRIFIÉ

[ESP] Pizarra metálica y magnética tríptica con marco de aluminio anodizado. Superficie blanca vitrificada apta para escritura con rotuladores de borrado en seco. 5 paneles para la escritura. Incluye bandeja para rotuladores y accesorios para la fijación a pared. Viene montada.

[ENG] Triptic enamelled whiteboard of anodized aluminium, 5 writing surfaces. Comes mounted.

[DE] Dreigeteiltes, emalliertes Whiteboard aus anodisiertem Aluminium, 5 Schreib-Oberflächen. Vormontiert.

[FR] Tableau triptyque en vitrifié avec cadre aluminium anodisé et 5 panneaux pour l'écriture. Livré monté.

Sólo superficie
Only surface

25 años de garantía
Years guarantee

MEJORADA
IMPROVED

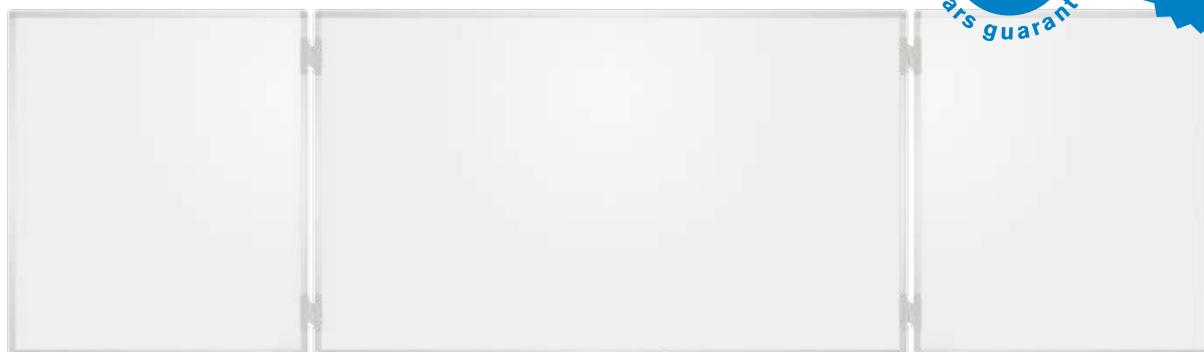

RD-S4319V19

Kit de limpieza y accesorios Skin
Cleaning kit and accessories

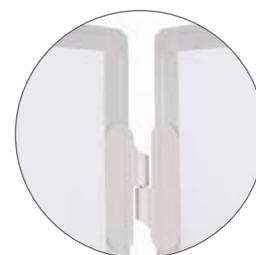

Superficie para rotuladores de borrado en seco.

Dry wipe surface.

Bitte niemals mit reinem Alkohol reinigen und keine
Tücher mit abrasiven Eigenschaften verwenden.

Surface effaçable à sec.

Medidas / Sizes (cm)

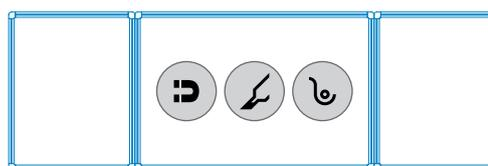
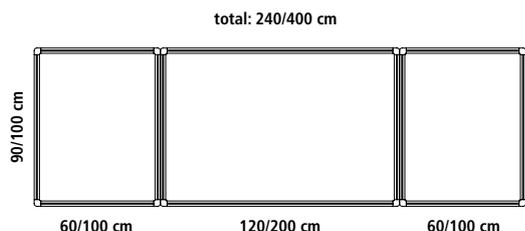

Vitrificada / enamelled / emailiert / vitrifié

Recomendada para uso diario / recommended for daily use

Ref.	cm (embalaje / packaging)	kg / m ³ (embalaje / packaging)
RD-6728 (240x90 cm)	133x92x5	20,52 kg / 0,061 m ³
RD-6729 (400x100 cm)	220x105x5	36,84 kg / 0,115 m ³

GUÍA DE PIZARRAS

WHITEBOARD GUIDE • ANWEISUNGEN FÜR TAFELN • GUIDE DE TABLEAU

SkinWhiteboard

Superficie Surface	Frecuencia de uso Use frequency (1 -10)	Resistencia a los arañazos Scratch Resistant	Magnético Magnetic	Garantía (años) warranty (years)	Alcohol	Limpieza Cleaning
Skin Colour	★★★★★ ☆☆☆☆☆	✗	✓	5	✗	Solo agua y regularmente Only water and regular cleaning
Skin Pro	★★★★★ ★★★☆☆	✗	✓	15	✓	Agua o alcohol, limpieza puntual Water and alcohol, puntual cleaning
Skin Ceramic	★★★★★ ★★★★★	✓	✓	25	✓	Agua o alcohol, limpieza puntual Water and alcohol, puntual cleaning

Otras · other

Superficie Surface	Frecuencia de uso Use frequency (1 -10)	Resistencia a los arañazos Scratch Resistant	Magnético Magnetic	Garantía (años) warranty (years)	Alcohol	Limpieza Cleaning
Melamina Melamine	☆☆☆☆☆ ☆☆☆☆☆	✗	✗	2	✗	Solo agua y regularmente Only water and regular cleaning
Lacada Lacquered	★★★★★ ☆☆☆☆☆	✗	✓	5	✗	Solo agua y regularmente Only water and regular cleaning
Cerámico - acero esmaltado Porcelain - enamel steel	★★★★★ ★★★★★	✓	✓	25	✓	Agua o alcohol, limpieza puntual Water and alcohol, puntual cleaning
Vidrio Glass	★★★★★ ★★★★★	✓	✗	25	✓	Agua o alcohol, limpieza puntual Water and alcohol, puntual cleaning

SOPORTE MÓVIL

MOBILE SUPPORT • STATIVDREHTAFEL • PIÉTEMENT MOBILE

[ESP] Soporte móvil volteable ajustable en altura. Incorpora un nuevo sistema FREE ROTATION único en el mercado que permite un giro seguro de la pizarra al cambiar de cara y evita cualquier movimiento de balanceo al escribir. El nuevo sistema de regulación de altura permite una adaptación total a cada usuario facilitando la escritura y la visualización de la misma. Robusta estructura realizada en tubo de acero. Incorpora bandeja para útiles de escritura y ruedas con freno de diseño. Fácil montaje. Pizarra no incluida.

[ENG] Adjustable height and mobile stand. It incorporates a new FREE ROTATION system. Unique in the market that allows a safe turn of the board when changing faces and prevents any movement of rolling when writing. The new height adjustment system allows a total adaptation to each user facilitating the writing and visualization of it. Robust structure made of steel tube. It incorporates a tray for writing tools and wheels with a designed brake. Easy assembly, whiteboard not included.

[DE] Mobiles und höhenverstellbares Drehgestell. Es ist mit dem neuen System FREE ROTATION versehen, das marktweit einzigartig ist und ein sicheres Drehen der Tafel beim Seitenwechsel ermöglicht sowie jegliche Schwingbewegung beim Schreiben verhindert. Das neue System zur Höhenverstellung erlaubt die vollständige Anpassung an jeden Benutzer und erleichtert das Schreiben sowie das Lesen. Robustes Gestell aus Stahlrohr. Einschließlich Schreibablage und feststellbare Laufrollen. Einfache Montage. Tafel nicht inbegriffen.

[FR] Support mobile pivotant réglable en hauteur. Il intègre un nouveau système FREE ROTATION unique sur le marché qui garantit une rotation sûre du tableau pour changer de face et évite tout type de mouvement de balancier lors de l'écriture. Grâce au nouveau système de réglage de la hauteur, il sera toujours parfaitement adapté à chaque utilisateur et facilite aussi bien l'écriture que la visualisation. Structure robuste fabriquée en tube d'acier. Plateau utile pour les outils d'écriture et roues équipées de frein. Installation facile. Tableau non inclus.



NEW

Nuevo sistema Free rotation que permite una rotación sin necesidad de herramientas, de forma directa que facilita la comunicación.

New Free rotation system that allows a rotation without the need of tools, in a direct way that facilitates communication.

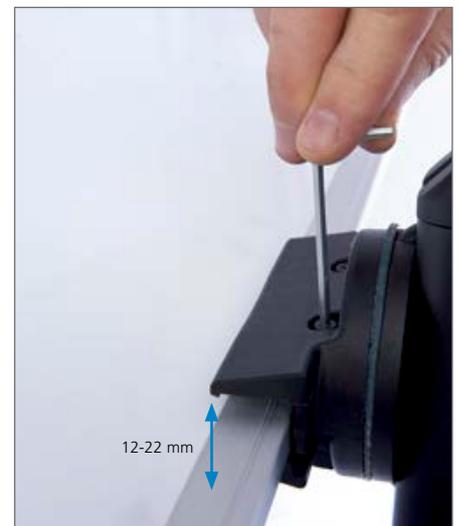

NEW



Nuevo sistema de anclaje que evita agujerear la pizarra.
New anchoring system that avoids piercing the board.



Fácil regulación de altura · Easy height adjustment



Bandeja de gran formato · Large tray

Medidas / Sizes (cm)

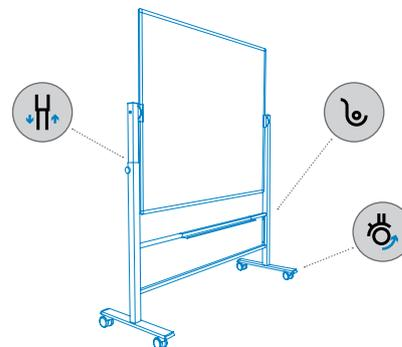
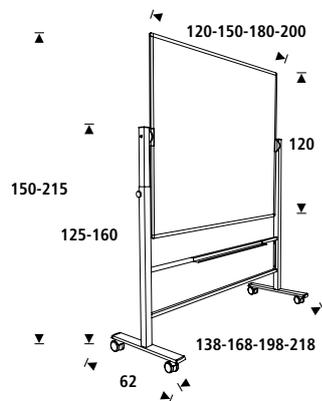

Ref.	cm (embalaje / packaging)	kg / m ³ (embalaje / packaging)
RD-6870PLUS (120 cm)	140x68x15	14,50 kg / 0,142 m ³
RD-6871PLUS (150 cm)	170x68x15	17,00 kg / 0,173 m ³
RD-6872PLUS (180 cm)	200x68x15	19,50 kg / 0,204 m ³
RD-6873PLUS (200 cm)	220x68x15	22,00 kg / 0,224 m ³

SOPORTE MÓVIL

MOBILE SUPPORT • STATIVDREHTAFEL • PIÉTEMENT MOBILE

[ESP] Soporte móvil volteable de gran diseño. Incorpora un nuevo sistema FREE ROTATION único en el mercado que permite un giro seguro de la pizarra al cambiar de cara y evita cualquier movimiento de balanceo al escribir. Su nuevo diseño curvado permite su utilización en una posición más cómoda para el usuario. Incorpora bandeja para útiles de escritura y ruedas con freno de diseño. Fácil montaje. Pizarra no incluida.

[ENG] High-quality designed metal mobile support with 'FREE ROTATION' safety turning system allowing writing on both sides of the board. Its new design provides the most comfortable position for the user. Incorporates a tray for writing tools. Easy to assemble. Board not included.

[DE] Mobile Stativdrehtafel mit komfortabler Einhand-Fixierung. Der Neigungswinkel der Tafel kann abgestuft eingestellt werden. Die gekrümmte Gestell-Form ermöglicht zwei unterschiedliche Arbeitspositionen. Stabile, feststellbare Laufrollen. Das schwarz pulverbeschichtete Gestell ist in vier Größen erhältlich, die doppelseitige Tafel ist entsprechend separat zu bestellen.

[FR] Support mobile métallique très design avec système de rotation de sécurité FREE ROTATION permettant d'écrire sur les deux faces du tableau. Son nouveau design permet de l'utiliser dans la position la plus pratique pour l'utilisateur. Livré avec un auget porte-accessoires d'écriture. Facile à monter. Tableau non inclus.



Nuevo sistema Free rotation que permite una rotación sin necesidad de herramientas, de forma directa que facilita la comunicación.

New Free rotation system that allows a rotation without the need of tools, in a direct way that facilitates communication.



Nuevo sistema de anclaje que evita agujerear la pizarra.
New anchoring system that avoids piercing the board.

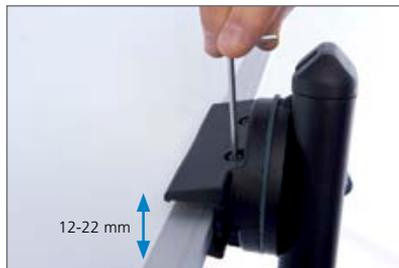

Bandeja de gran formato · Large tray

Medidas / Sizes (cm)

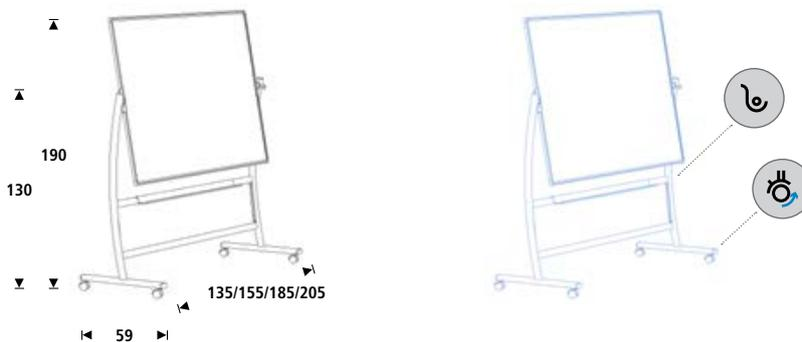

Ref.	cm (embalaje / packaging)	kg / m ³ (embalaje / packaging)
RD-6870 (120 cm)	140x68x15	14,50 kg / 0,142 m ³
RD-6871 (150 cm)	170x68x15	17,00 kg / 0,173 m ³
RD-6872 (180 cm)	200x68x15	19,50 kg / 0,204 m ³
RD-6873 (200 cm)	220x68x15	22,00 kg / 0,224 m ³
RD-6871PK Soporte + pizarra RD-6951 de 150cm Support + 150cm whiteboard RD-6951	171x127x14	33,40 kg / 0,293 m ³

SOPORTE TRÍPODE

TRIPOD SUPPORT • STATIV • SUPPORT TRÉPIEDS

[ESP] Soporte universal de pizarras de pared regulable en altura acabado en epoxy color gris. Viene montado.

[ENG] Universal height adjustable support for whiteboard. Powder coated in grey finish. Delivered assembled.

[DE] Universal-Stativ für Wandtafeln. Vormontiert.

[FR] Support universel pour tableaux. Livré monté.

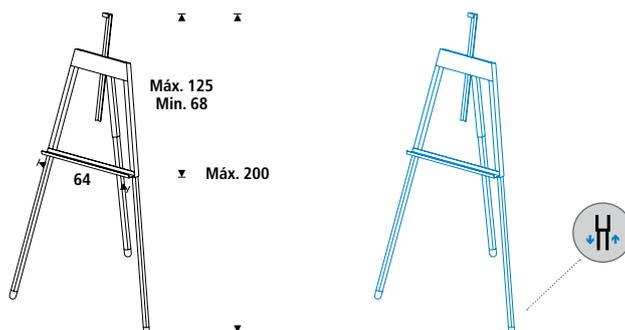
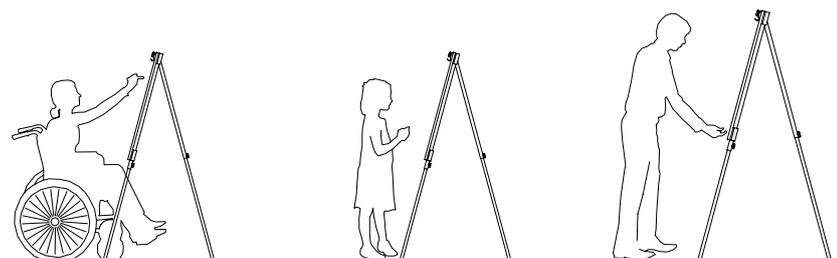

Ref.	cm (embalaje / packaging)	kg / m (embalaje / packaging)
RD-8090	117X67X10	8 kg / 0,078 m ³

SOPORTE MÓVIL UNIVERSAL

UNIVERSAL MOBILE SUPPORT • UNIVERSELLE MOBILE UNTERSTÜTZUNG
SUPPORT MOBILE UNIVERSEL

[ESP] Soporte móvil universal de pizarras de pared que permite la fijación de pizarras de de 90cm, 100cm y 120cm de alto. Incorpora ruedas con freno. Opción con niveladores bajo pedido. Fácil montaje

[ENG] Universal mobile stand of whiteboards that allows to be fixed at 90cm, 100cm and 120cm wide. It includes wheels with brake system. An option with levelers on request. Easy to assemble.

[DE] Universelles, mobiles Gestell für whiteboards bis 2m, das bei einer Breite von 90cm, 100cm und 120cm fixiert werden kann. Es enthält Rollen mit Bremssystem. Auf Nachfrage mit Nivellierern erhältlich. Einfach aufzustellen.

[FR] Support de tableau mobile universel. Il permet la fixation des tableaux d'une largeur de 90 à 120 cm. Il comprend des roues avec un système de frein. (Si vous voulez un tableau avec des pieds pour qu'il reste fixe, vous pouvez en faire la demande).



Longitud pizarra max. 2m.
Pizarra no incluida
Whiteboard length max 2m.
Board not included



Medidas / Sizes (cm)

Indicado para pizarras de 90, 100 y 120 cm de alto
Suitable for 90, 100 and 120 high flipcharts

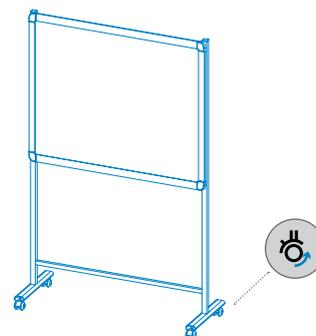
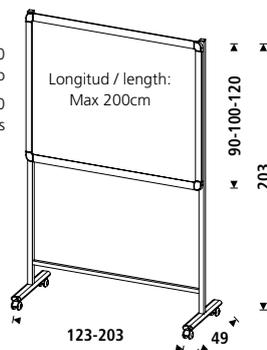

Ref.	cm (embalaje / packaging)	kg / m (embalaje / packaging)
RD-6877 (sólo soporte / only support)	190x6x6	9 kg / 0,006 m ³

PIZARRA

BOARD • SCHREIBTAFEL • TABLEAU

[ESP] Pizarra con marco de pino. Superficie blanca apta para la escritura con rotuladores de borrado en seco. Incluye accesorios para la fijación a pared. Viene montada.

[ENG] Board with pine frame with surface suitable for writing with dry-wipe markers. Includes accessories for wall fixing. Comes assembled.

[DE] Schreibtafel mit Kieferholzrahmen. Zum Beschreiben mit trocken abwischbaren Markern. Inklusive Zubehör für die Wandmontage. Lieferung nur auf Anfrage.

[FR] Tableau avec cadre en pin et surface pour écriture au marqueur effaçable à sec Fourni avec kit pour fixation murale. Livré monté.

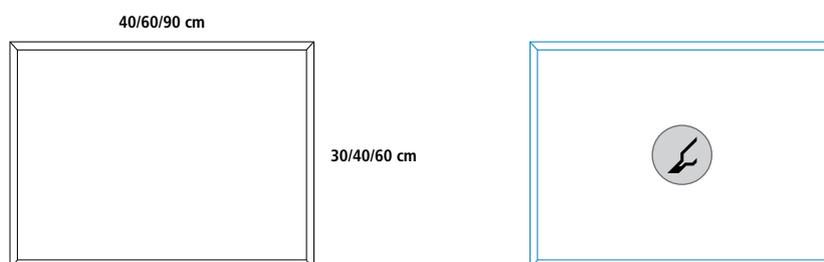

Melamina / melamine / melamine / melaminé

Recomendada para uso normal / recommended for normal use

Ref.	cm (embalaje / packaging)	kg / m ³ (embalaje / packaging)
RD-6106V19 (40x30 cm) (10u.)	61x41x29	15,90 kg / 0,073 m ³
RD-6107V19 (60x40 cm) (10u.)	61x41x29	14,60 kg / 0,073 m ³
RD-6108V19 (90x60 cm) (5u.)	81x61x15	15,10 kg / 0,074 m ³

PIZARRA

BOARD • KOMBITAFEL • TABLEAU

[ESP] Pizarra combinada con superficie mitad en metal blanco para utilizar con rotuladores de borrado en seco y mitad en corcho autorregenerable. Construida con marco de pino. Incluye accesorios para la fijación a pared. Viene montada.

[ENG] Combined board with half-metal and half-cork surface and pine frame. Includes accessories for wall fixing. Comes assembled.

[DE] Kombination aus Schreib- und Pinntafel, zur einen Hälfte mit Metalloberfläche, zur anderen Hälfte mit Korkoberfläche. Mit Kieferholzrahmen. Inklusive Zubehör für die Wandmontage. Lieferung nur auf Anfrage.

[FR] Tableau combiné avec surface moitié metal, moitié liège et cadre en pin Fourni avec kit pour fixation murale. Livré monté.

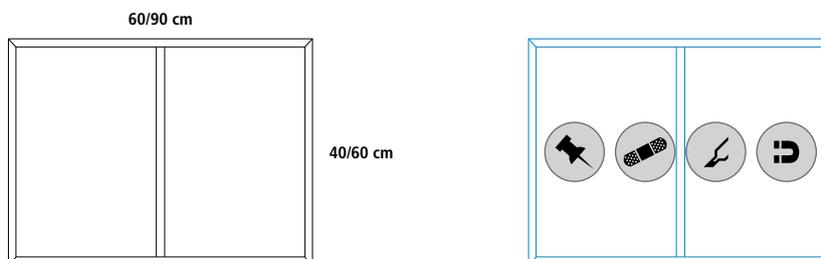

Ref.	cm (embalaje / packaging)	kg / m ³ (embalaje / packaging)
RD-6120V19 (60x40 cm) (10u.)	61x41x30	16,00 kg / 0,075 m ³
RD-6121V19 (90x60 cm) (10u.)	91x61x16	15,50 kg / 0,089 m ³

PIZARRAS DE CORCHO

CORKBOARDS • KORKTAFELN • TABLEAUX EN LIÈGE

[ESP] Tablero de corcho con marco de pino. Incluye accesorios para la fijación a pared. Viene montada.

[ENG] Corkboard with pine frame. Includes accessories for wall fixing. Comes assembled.

[DE] Korktafel mit Kieferholzrahmen. Inklusive Zubehör für die Wandmontage. Lieferung nur auf Anfrage.

[FR] Tableau en liège et cadre en pin. Fourni avec kit pour fixation murale. Livré monté.

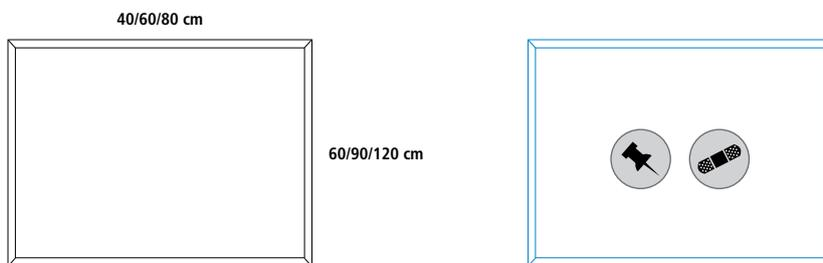
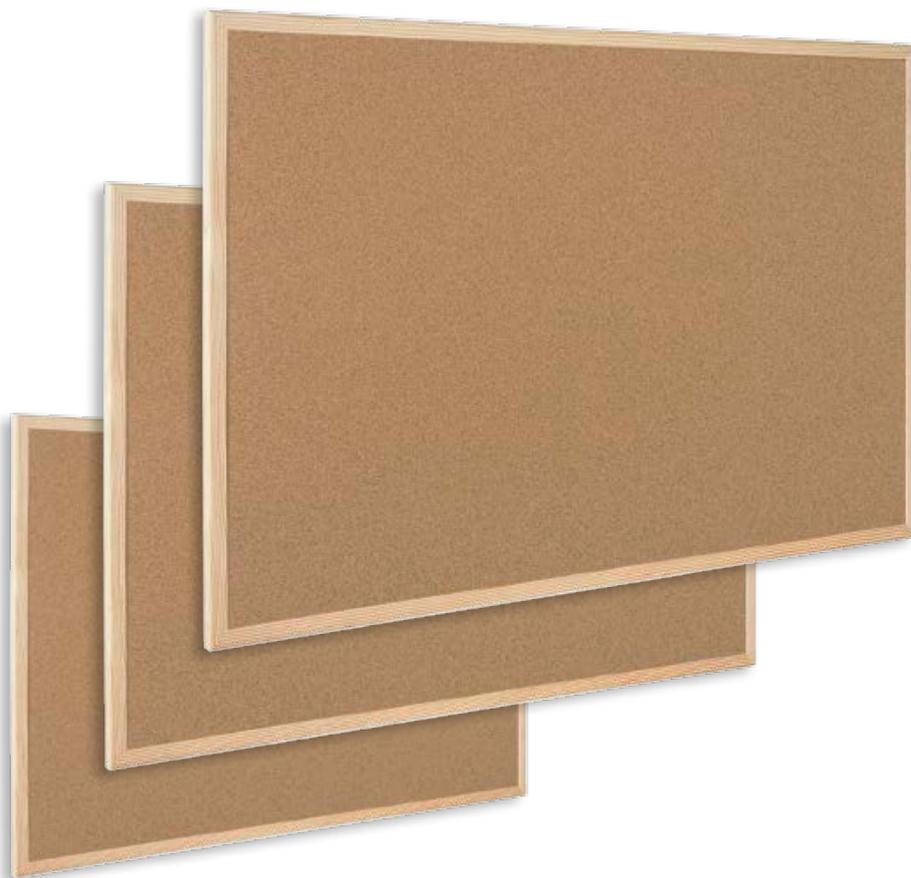

Ref.	cm (embalaje / packaging)	kg / m ³ (embalaje / packaging)
RD-6100V19 (60x40 cm) (10u.)	61x41x30	11,00 kg / 0,081 m ³
RD-6102V19 (90x60 cm) (10u.)	91x61x15	11,00 kg / 0,083 m ³
RD-6103V19 (120x60 cm) (5u.)	121x61x10	10,00 kg / 0,073 m ³
RD-6111V19 (120x80 cm) (5u.)	121x81x10	17,00 kg / 0,098 m ³

ACCESORIOS PIZARRAS BLANCAS Y DE PARED

WHITEBOARD AND FLIPCHART ACCESSORIES • SCHREIBTAFEL-UND FLIPCHARTZUBEHÖR
ACCESSOIRES POUR TABLEAUX BLANC

[ESP] Kit de limpieza y accesorios.

Incluye: 4 rotuladores de colores mezclados, 10 imanes de Ø30mm de colores mezclados, cubilete magnético para rotuladores, estuche con 25 toallitas de limpieza, unidad de recambio con otras 25 toallitas adicionales y borrador magnético de gran adherencia.

[ENG] Cleaning and accessory kit.

Includes: 4 different coloured marker pens, 10 different coloured Ø30mm magnets, magnetic cup for marker pens, case with 25 cleaning wipes, a replacement unit with another 25 wipes and magnetic eraser.

[DE] Das perfekte Zubehörset. Enthält: 4 Boardmarker (je 1 St. in schwarzrot, blau, grün. 10 Magnete Ø 30mm farbig sortiert. 1 magnetischer Marker- und Zubehörcöcher (weiss). 1 magnetische Box mit 25 Feucht-reinigungstüchern und einem Refillpack mit 25 weiteren Feuchttüchern für die regelmäßige Pflege, nachhaltige Grundreinigung von skin whiteboards und Magnethafter Radierer.

[FR] Kit de nettoyage et accessoires.

Comprend : 4 marqueurs couleurs assorties, 10 plots magnétiques de 30 mm de Ø couleurs assorties, pot magnétique pour les marqueurs, paquet de 25 lingettes nettoyantes, une unité de rechange avec 25 lingettes supplémentaires, et Effaceur haute adhérence.



Ref.	cm (embalaje / packaging)	kg / m ³ (embalaje / packaging)
RD-S4319V19	25x11x6	0,55 kg / 0,001 m ³

BORRADOR MAGNÉTICO

MAGNETIC ERASER • TAFELLÖSCHER MAGNETISCH • EFFACEUR MAGNÉTIQUE

[ESP] Borrador magnético de alta adherencia gracias a su potente imán. Perfecto para pizarras convencionales y pizarras de cristal magnéticas.

[ENG] Magnetic eraser with adhesion thanks to its powerful magnet. Perfect for conventional whiteboards and glass magnetic whiteboards

[DE] Magnethafter Radierer mit hoher Haftung dank seines starken Magneten. Perfekt für konventionelle und magnetische Glastafeln.

[FR] Effaceur haute adhérence grâce a son aimant puissant. Parfait pour tableaux standards et tableaux verres magnétiques.



Ref.	cm (embalaje / packaging)	kg / m ³ (embalaje / packaging)
RD-S4300V19	12x7x3	0,10 kg / 0,001 m ³

TOALLITAS

CLEANING WIPES • FEUCHT-REINIGUNGSTÜCHERN
LINGETTES NETTOYANTES

[ESP] Estuche magnético con 25 toallitas de limpieza.

[ENG] Case with 25 cleaning wipes.

[DE] Box mit 25 Feucht-reinigungstüchern.

[FR] Paquet de 25 lingettes nettoyantes.

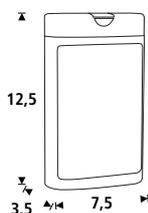

Ref.	cm (embalaje / packaging)	kg / m ³ (embalaje / packaging)
RD-S4320 (1 estuche / case)	13x8x4	0,10 kg / 0,001 m ³

RECAMBIO PARA TOALLITAS

REPLACEMENT UNIT • REFILLPACK • UNITÉ DE RECHANGE

[ESP] Recambio de 25 toallitas.

[ENG] Replacement unit with 25 wipes.

[DE] Refillpack mit 25 weiteren Feuchttüchern für die regelmäßige.

[FR] Unité de recharge de 25 lingettes.

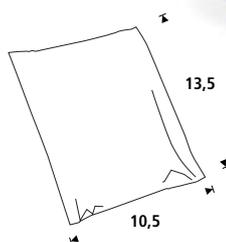

Ref.	cm (embalaje / packaging)	kg / m ³ (embalaje / packaging)
RD-S4321 (1 pack)	14x11x2	0,07 kg / 0,001 m ³

CUBILETE PARA ROTULADORES

PENCIL CUP • KÖCHER • POT A CRAYONS

[ESP] Cubilete magnético para rotuladores realizado en polímero técnico.

[ENG] Magnetic pencil cup made in technical polymer.

[DE] Magnetischer Köcher.

[FR] Pot à crayons magnétique.

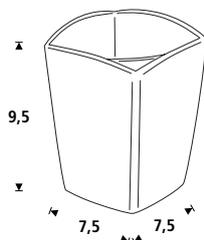

RD-530WH

RD-530GR



Ref.	cm (embalaje / packaging)	kg / m ³ (embalaje / packaging)
RD-530GR verde / green	25x11x6	0,11 kg / 0,001 m ³
RD-530WH blanco / white	25x11x6	0,11 kg / 0,001 m ³
RD-530GR*12 verde / green (12 u.)	29x22x11	1,35 kg / 0,006 m ³
RD-530WH*12 blanco / white (12 u.)	29x22x11	1,35 kg / 0,006 m ³

IMANES

MAGNETS • MAGNETE • AIMANTS

[ESP] 10 Imanes ø 30 colores mezclados.

[ENG] 10 Magnets ø 30 mixed colours.

[DE] 10 Magnete ø 30 farbig sortiert.

[FR] 10 Aimants ø 30 couleurs assorties.

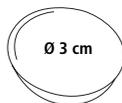

Ref.	cm (embalaje / packaging)	kg / m ³ (embalaje / packaging)	Unidades / units
I4319	6x4x3	0,135 kg / 0,001 m ³	10 u.

IMANES "SMILEY"

"SMILEY" MAGNETS • "SMILEY" MAGNETE • AIMANTS "SMILEY"

[ESP] 15 imanes (5 verde / 5 amarillo / 5 rojo).

[ENG] 15 magnets (5 green / 5 yellow / 5 red).

[DE] 15 Magnete (5 grün / 5 gelb / 5 rot).

[FR] 15 aimants (5 vert / 5 jaune / 5 rouge).

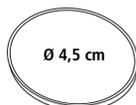

Ref.	cm (embalaje / packaging)	kg / m ³ (embalaje / packaging)	Unidades / units
Smiley15	10x10x1	0,10 kg / 0,001 m ³	15 (5 x  , 5 x  , 5 x )

ROTULADORES

BOARD MARKERS • TAFELSCHREIBER • MARQUEURS

[ESP] Rotuladores para pizarra blanca, punta redondeada 2-6 mm y uso para borrado en seco.

[ENG] Board markers for whiteboards, 2-6 mm rounded tip, and for dry erasing.

[DE] Tafelschreiber für weisse Tafeln, 2-6 mm Rundspitze, und trocken abwischbar.

[FR] Marqueurs pour tableau blanc, pointe ronde 2-6 mm, et uniquement pour effaçage à sec.

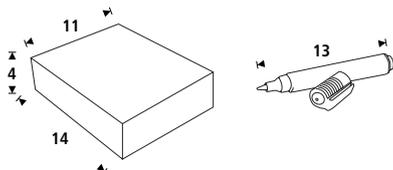

RD-S4040RD*12



Ref.	cm (embalaje / packaging)	kg / m ³ (embalaje / packaging)
 RD-S4040BK*12 (12u)	14x11x4	0,20 kg / 0,001 m ³
 RD-S4040BL*12 (12u)	14x11x4	0,20 kg / 0,001 m ³
 RD-S4040RD*12 (12u)	14x11x4	0,20 kg / 0,001 m ³
 RD-S4040GR*12 (12u)	14x11x4	0,20 kg / 0,001 m ³
RD-S4040MX*12 (6+2+2+2u)	14x11x4	0,20 kg / 0,001 m ³

ROTULADORES DE TIZA

CHALK MARKERS • KREIDEMARKER • MARQUEURS À CRAIE

[ESP] Rotuladores de tiza para superficies lisas como vidrio, azulejos, espejos, metales, plásticos, etc

[ENG] Chalk markers for smooth surfaces such as glass, tiles, mirrors, metal, plastics, etc

[DE] Kreidemarker für glatte Oberflächen wie Glas, Kacheln, Spiegel, Metall, Kunststoff, etc

[FR] Marqueurs à craie pour surfaces lisses, par ex. verre, carreaux, miroirs, métal, plastique, etc.

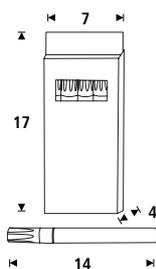

Ref.	cm (embalaje / packaging)	kg / m ³ (embalaje / packaging)	Unidades / units
RD-S5050MX	17x7x2cm	0,8 kg / 0,001 m ³	4 u.

FUNDAS MAGNÉTICAS

MAGNETIC SLEEVES MAGNETISCHE DOKUMENTENHALTER • PROTECTIONS MAGNÉTIQUES

[ESP] Fundas magnéticas para documentos para todo tipo de usos. Se pueden cambiar los documentos con frecuencia gracias a su estructura de plástico de abertura fácil y que los mantiene limpios en todo momento.

[ENG] Magnetic sleeves for any type of document. You can change them frequently thanks to their easy-opening plastic format, which always keeps them clean.

[DE] Magnetische Dokumentenhalter. Auf drei Seiten der Rückseite sind Magnetstreifen angebracht, durch die offene Seite können die Dokumente beliebig oft ausgetauscht werden, ohne dass der Dokumentenhalter von seinem Untergrund entfernt werden muss.

[FR] Protections magnétiques transparentes pour protéger et changer facilement et à volonté tout type de document.



Ref.	Medidas / size	Unidades / units
RD-S0301A4 (5u.)	A4 (33x24x2)	0,5 kg / 0,001 m ³
RD-S0301A3 (5u.)	A3 (45x33x2)	1 kg / 0,002 m ³
RD-S0301A1 (1u.)	A1 (87x63x2)	1 kg / 0,010 m ³

SKINNY NOTES

[ESP] Notas informativas removibles sin adhesivo. Permite la escritura en ambas caras con todo tipo de rotulador.

[ENG] Removable non-adhesive informative notes. Allows writing on both sides with any kind of marker.

[DE] Entfernbar Info-Notizen ohne Klebstoff. Ermöglicht das beidseitige Beschreiben mit jeglicher Art von Stift oder Marker.

[FR] Note re-positionnable, sans adhésif tout type de marqueur peut être utilisé sur chaque face.



Ref.	Medidas / size	cm (embalaje / packaging)	kg / m ³ (embalaje / packaging)	Hojas / sheets
RD-S4323MX (20x10cm)	20x10 cm	20x10x2	0,30 kg / 0,001 m ³	400 (100 / color)
RD-S4324MX (12,5x12,5cm)	13x12,5 cm	12,5x12,5x2	0,20 kg / 0,001 m ³	400 (100 / color)

SPRAY DE LIMPIEZA

CLEANING SPRAY • REINIGUNGSSPRAY
SPRAY NETTOYANT

[ESP] Spray de limpieza 250 ml.

[ENG] Cleaning spray 250 ml.

[DE] Reinigungsspray 250 ml.

[FR] Spray nettoyant 250 ml.

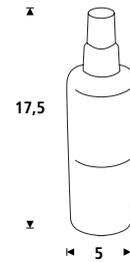

Ref.	cm (embalaje / packaging)	kg / m ³ (embalaje / packaging)
RD-54200 (1u. / 250 ml)	19x5x5	0,25 kg / 0,001 m ³

BLOC DE PAPEL

PAPER BLOCK • PAPIERBLOCK • BLOC PAPIER

[ESP] Bloc papel 20 hojas. 70 gr. Universal para todas las pizarras.

[ENG] Paper block of 20 sheets of 70 gr. Universal for all boards.

[DE] Papierblock mit 20 Blättern. 70 g. Universell für alle Tafeln.

[FR] Bloc papier 20 feuilles, 70 gr. Universel pour tous les tableaux.

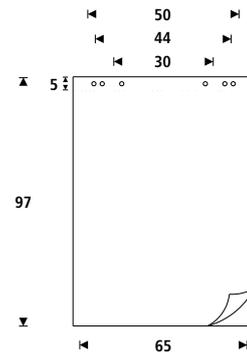

Ref.	cm (embalaje / packaging)	kg / m ³ (embalaje / packaging)
RD-630 (1u.)	87x8x8	0,85 kg / 0,010 m ³
RD-631 (5u.)	101x67x1	4,95 kg / 0,007 m ³

REVISTERO MAGNÉTICO

WALL LETTER TRAY • MAGNETISCHER WANDBRIEFKORB MAGNETIC CORBEILLE

[ESP] Revistero magnético de gran diseño que admite documentos hasta 24x32cm. Su diseño permite sostener documentos A3 y mantener una fácil accesibilidad. Hasta 2kg. Realizado en poliestireno reciclable. (1 unidad por caja).

[ENG] Magnetic wall letter tray, which can be applied to any metallic surface, carries up to 2 kg. For documents up to A4 size. U-groove on the sides for documents up to A3 format. V-groove on the front panel allow the storage of small documents such as envelopes. (1 unit per box).

[DE] Magnetischer Wandbriefkorb, der sich auf jeder metallischen Fläche anbringen lässt, trägt bis zu 2 kg. Für Dokumente bis DIN A4-Format. U-Aussparung an den Seiten für Dokumente bis DIN A3-Format. V-Aussparung an der Frontseite ermöglicht das Aufbewahren von kleinen Dokumenten wie Briefumschlägen.

[FR] Corbeille murale magnétique, à courrier de paroi, qui peut être appliqué à toute surface métallique, comporte jusqu'à 2 kg. Pour documents jusqu'au format A4. Rainure en U sur les côtés pour les documents jusqu'au format A3. Rainure en V sur le panneau avant permet le stockage de petits documents tels que des enveloppes.

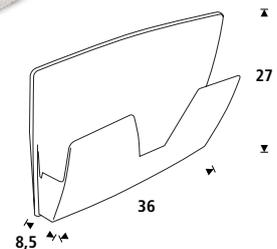

Ref.	cm (embalaje / packaging)	kg / m ³ (embalaje / packaging)
2981GY (Gris / Grey)	38x28x11	0,60 kg / 0,011 m ³

PIZARRA TRANSFORMABLE EN MESA

FLIPCHART CONVERTIBLE INTO TABLE • MOBILES MULTIFUNKTIONSFLIPCHART
TABLEAU TRANSFORMABLE EN TABLE

[ESP] Pizarra móvil metálica, magnética para escritura con rotuladores de borrado en seco. Admite bloc de papel universal. Regulable en altura mediante muelles. Su regulación permite trabajar sentado para gente con algún tipo de discapacidad. Convertible en mesa. Incluye 2 brazos telescópicos. Fácil montaje.

[ENG] Mobile, flipchart with quality magnetic, dry-wipe surface. The surface revolves 90° to allow a flat working surface to use as an AV stand or table. Height adjustable through a smooth spring mechanism. Can be used at sitting height for disabled or wheelchair users. Universal fixings for flipchart pad. 2 telescopic arms for additional presentation. Easy to assemble.

[DE] Mobiles Multifunktions-Flipchart mit magnethaftender, hochwertig beschichteter Oberfläche und besonders stabilem Metall-Rundfuß. Kann trocken abwischbar beschriftet werden. Die Tafelfläche lässt sich um 90° kippen und als temporäre Tischfläche nutzen. Höhenverstellbar mittels Spiralfeder. Die untere Höheneinstellung ermöglicht ein Arbeiten am Flipchart auch im Sitzen, somit eignet sich dieses Flipchartmodell u.a. auch gut für Rollstuhlfahrer. Schnellwechselblockhalter für marktübliche Flipchart-Papierblöcke. Zwei seitliche einsteckbare Konzepthalter erweitern die Präsentationsfläche bei Bedarf. Einfache Montage.

[FR] Tableau métallique mobile, aimanté, pour écriture avec feutres. Peut recevoir des blocs de papier universels. Réglable en hauteur par système à ressort. L'amplitude de réglage permet de travailler en position assise (par exemple pour handicapés en chaise roulante). Transformable en table. Dispose de deux bras télescopiques latéraux. Montage facile.

CERTIFICADA
CERTIFIED



Superficie para rotuladores de borrado en seco.
No limpiar con alcohol o productos abrasivos.
Dry wipe surface. Never clean it with alcohol or abrasive products.
Bitte niemals mit reinem Alkohol reinigen und keine Tücher mit abrasiven Eigenschaften verwenden.
Surface effaçable à sec. Ne nettoyer jamais la surface avec de l'alcool ou un produit abrasif.



Incluye un rotulador
Marker included

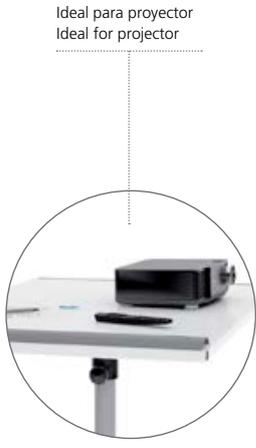

Ideal para proyector
Ideal for projector



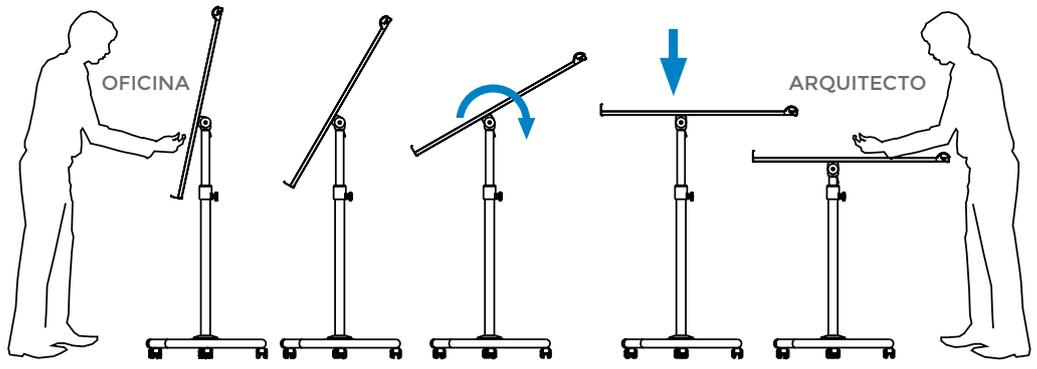
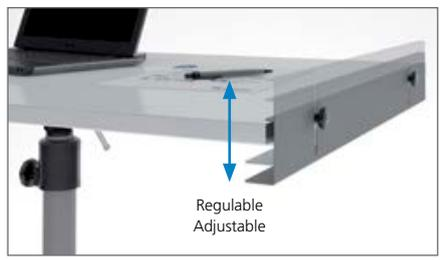

Medidas / Sizes (cm)

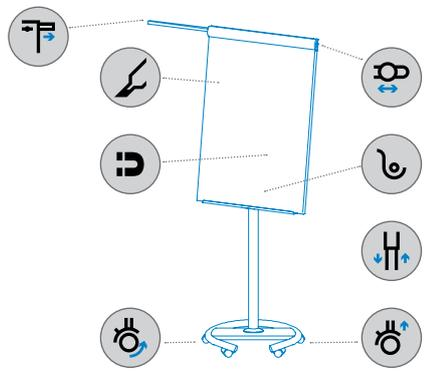
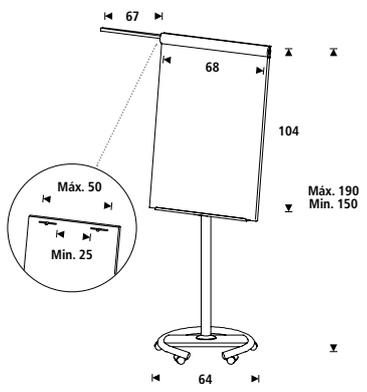

RD-619
Bandeja porta útiles de cristal
Optional glass tray

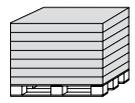

RD-618V15 - palet / pallet 8 u. - 80x120x120 cm

Ref.	cm (embalaje / packaging)	kg / m ³ (embalaje / packaging)	Color
○ RD-618	118x79x9	18,65 kg / 0,083 m ³	
● RD-618-630	118x79x9	18,65 kg / 0,083 m ³	RAL 630
RD-619 opcional / optional	70x35x8	3 kg / 0.019 m ³	

PIZARRAS MÓVILES

MOBILE FLIPCHARTS • MOBILE FLIPCHARTS • TABLEAUX MOBILES

[ESP] Pizarra móvil metálica, magnética y curvada con sistema patentado Flip-Roll de serie. Sólo papelógrafo. Permite trabajar con rollo o con bloc de papel universal. Regulación de altura mediante muelle. Incluye un brazo telescópico y rollo de papel K-635 de 35m. Fácil montaje.

[ENG] Mobile magnetic, metallic and curved flipchart, with patented flip-roll system, "only papergraph". Allows working with roll or universal paper block. Height adjustment through a spring. Telescopic arm and paper block K-635 included. Easy assembly.

[DE] Mobiles Metallflipchart mit geschwungener Tafeloberfläche und patentiertem Flip Roll System. Verwendbar mit einer Papierrolle oder mit einem Universalpapierblock. Hochwertige Metallic-Pulverbeschichtung. Höhenverstellung 170 – 200 cm mittels Spiralfeder. Mit Bildhalter.

[FR] Tableau de conférence magnétique, mobile, métal, galbé, avec système exclusif breveté flip-roll, "seulement papiergraph". Permet l'utilisation de rouleau de papier ou de bloc papier universel. Réglage en hauteur assisté par ressort. Avec bras télescopique et rouleau papier K-635. Facile à monter.



Incluye un rotulador
Marker included



K-635
 Rollo de papel de 35m para RD 660
 35m Paper roll for: RD 660
 35m Papierrolle für: RD 660
 Rouleau papier 35 m pour: RD 660



RD-619
 Bandeja porta útiles de cristal
 Optional glass tray



Brazo telescópico
 Telescopic arm



Ruedas a presión
 Click system castors



Sujeción del rollo de papel
 Paper roll fastening



Bandeja para rotulador
 Marker tray

Medidas / Sizes (cm)

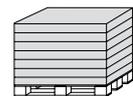
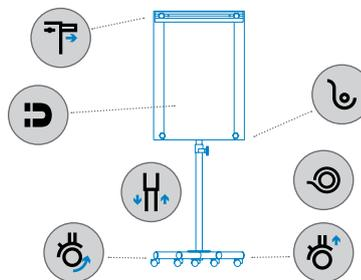
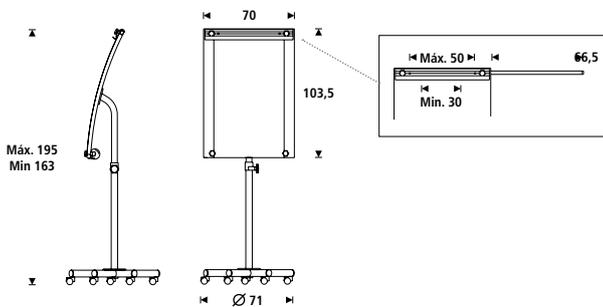

RD-660 - palet / pallet 5 u. - 80x120x115 cm

Ref.	cm (embalaje / packaging)	kg / m ³ (embalaje / packaging)
RD-660	77x21x113	21,5 kg / 0,183 m ³
K-635 opcional / optional	68x8x8	1,85 kg / 0,010 m ³
RD-619 opcional / optional	70x35x8	3 kg / 0.019 m ³

PIZARRAS MÓVILES

MOBILE FLIPCHARTS • MOBILE FLIPCHARTS • TABLEAUX MOBILES

[ESP] Pizarra móvil metálica, magnética para escritura con rotuladores de borrado en seco. Admite bloc de papel universal. Regulable en altura mediante muelles. Incluye 2 brazos telescópicos. Fácil montaje.

[ENG] Mobile, flipchart with quality magnetic, dry-wipe surface. Height adjustable through a smooth spring mechanism. Universal fixings for flipchart pad. 2 telescopic arms for additional presentation. Easy to assemble.

[DE] Mobiles Flipchart mit stabilem, ergonomisch geformtem Metall-Rundfuß. Die neuartige, patentierte Höhenverstellung mit Federmechanismus und Sicherheitssperre ermöglicht die stufenlose Einstellung der individuellen Arbeitshöhe. Der Schnellwechselblockhalter mit Klappmechanik ist für alle handelsüblichen Flipchartblocks geeignet. Die Pulverbeschichtung der Tafel gewährleistet grundsätzlich gute Beschriftungs- und Abwischigenschaften für Boardmarker auf Alkoholbasis. Zwei seitlich einsteckbare, magnethaftende Papierhalter erweitern die Präsentationsfläche auf das dreifache. Ablageleiste aus Metall.

[FR] Tableau métallique mobile, aimanté, pour écriture avec feutres. Peut recevoir des blocs de papier universels. Réglable en hauteur par système à ressort. Dispose de deux bras télescopiques latéraux. Montage facile.

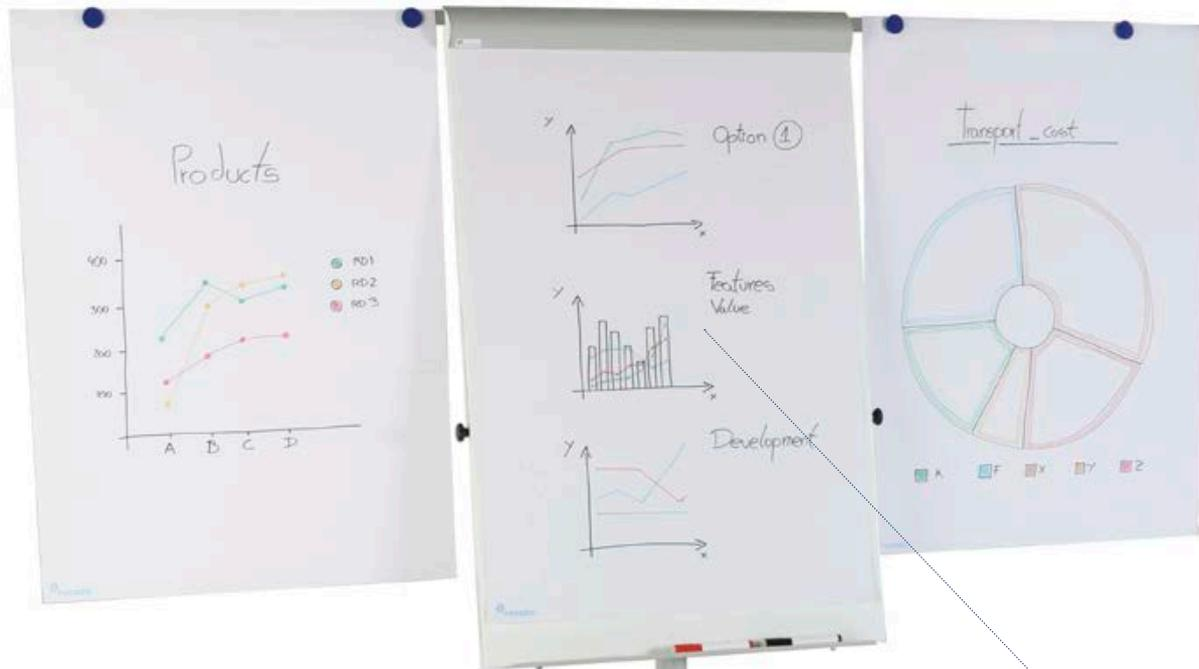

Incluye un rotulador
Marker included



Superficie para rotuladores de borrado en seco.
No limpiar con alcohol o productos abrasivos.
Dry wipe surface. Never clean it with alcohol or abrasive products.
Bitte niemals mit reinem Alkohol reinigen und keine Tücher mit abrasiven Eigenschaften verwenden.
Surface effaçable à sec. Ne nettoyer jamais la surface avec de l'alcool ou un produit abrasif.

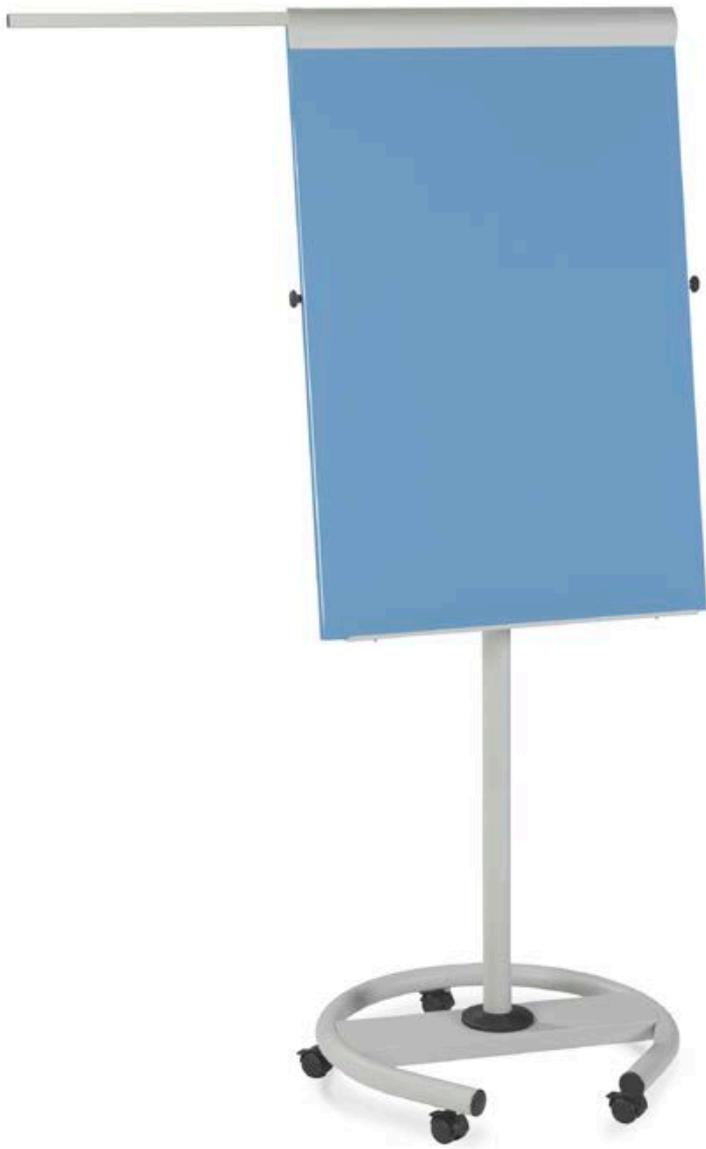

Sistema bloc de paper universal
Universal paper block system

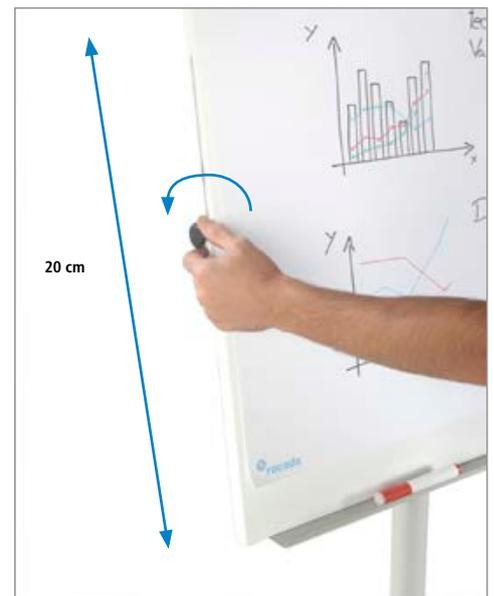

Medidas / Sizes (cm)

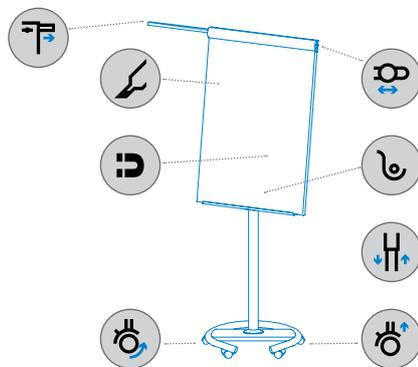
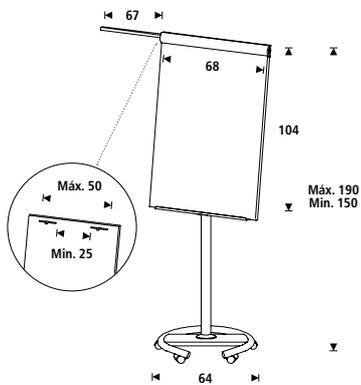

RD-619
Bandeja porta útiles de cristal
Optional glass tray

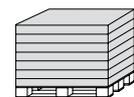

RD-617V15 - palet / pallet 8 u. - 80x120x120 cm

Ref.	cm (embalaje / packaging)	kg / m ³ (embalaje / packaging)	Color
RD-617	116x80x10	17,3 kg / 0,093 m ³	○
RD-617-630	116x80x10	17,3 kg / 0,093 m ³	● RAL 630
RD-619 opcional / optional	70x35x8	3 kg / 0.019 m ³	

PIZARRAS MÓVILES

MOBILE FLIPCHARTS • MOBILE FLIPCHARTS • TABLEAUX MOBILES

[ESP] Pizarra móvil metálica y magnética, apta para escritura con rotuladores de borrado en seco. Admite bloc de papel universal. No regulable en altura. Incluye 1 brazo telescópico. Fácil montaje.

[ENG] Mobile magnetic metal flipchart for writing with dry-wipe markers. Takes universal paper block. Not height-adjustable. Includes 1 telescopic arm. Easy to assemble.

[DE] Funktionell und mit der Konzentration auf das Wesentliche – das mobile Flipchart mit fester Aufstellhöhe. Stabiler Kunststofffuß. Magnethaftende Tafeloberfläche, für trocken abwischbare Beschriftung geeignet. Schnellwechselblockhalter für marktübliche Flipchart-Papierblöcke. 1 Inklusive Teleskoparm. Feststellbare Laufrollen.

[FR] Tableau mobile métallique, magnétique pour écriture au marqueur effaçable à sec. Peut recevoir bloc de papier universel. Non réglable en hauteur. N'admet pas de bras télescopiques. Inclut 1 bras télescopique. Facile à monter.

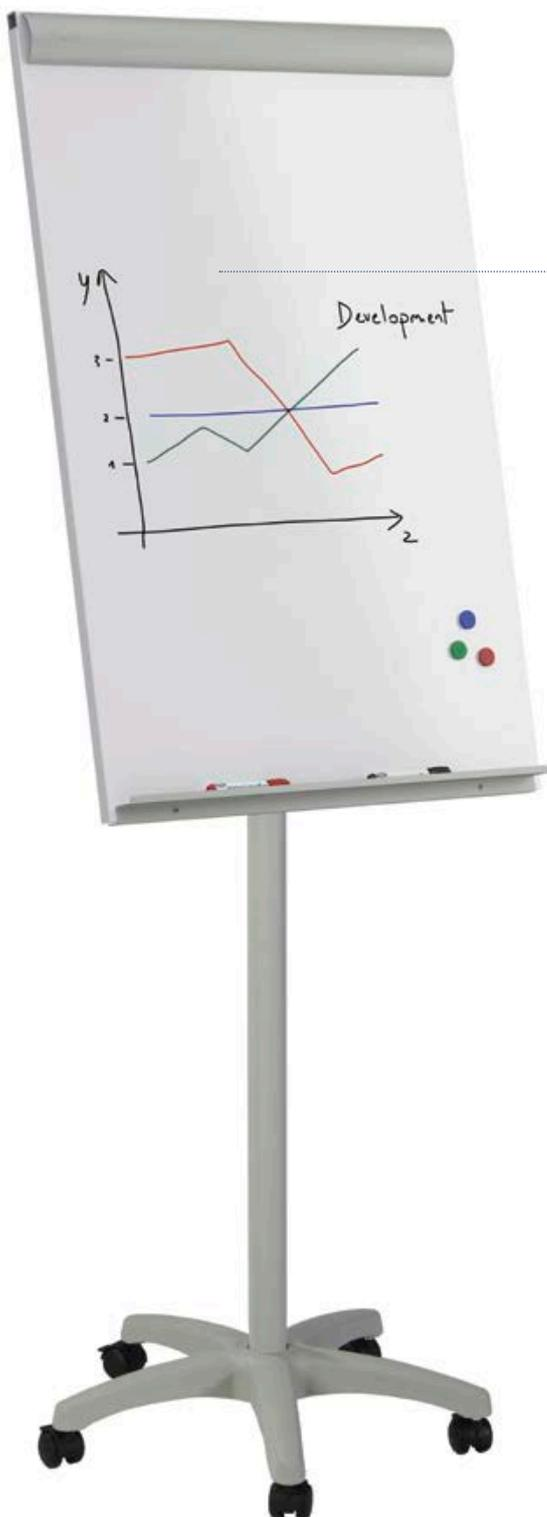

Superficie para rotuladores de borrado en seco.
No limpiar con alcohol o productos abrasivos.

Dry wipe surface. Never clean it with alcohol or abrasive products.

Bitte niemals mit reinem Alkohol reinigen und keine Tücher mit
abrasiven Eigenschaften verwenden.

Surface effaçable à sec. Ne nettoyer jamais la surface avec de
l'alcool ou un produit abrasif.



Incluye un rotulador
Marker included



Sistema bloc de papel universal / Universal paper block system



Ruedas a presión
Click system castors

Medidas / Sizes (cm)

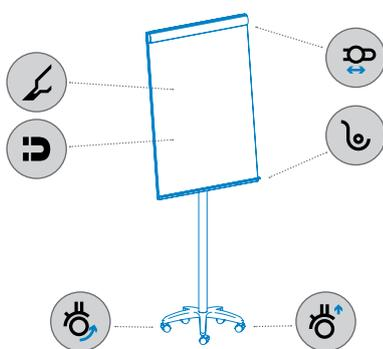
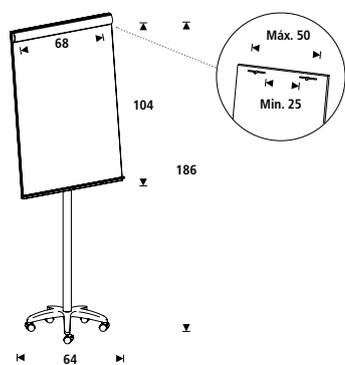

RD-619
Bandeja porta útiles de cristal
Optional glass tray

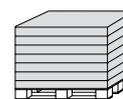

RD-616 - palet / pallet 8 u. - 80x120x120 cm

Ref.	cm (embalaje / packaging)	kg / m ³ (embalaje / packaging)	Color
RD-616	115x79x12	13,7 kg / 0,108 m ³	blanco / white ○
RD-616-630*	115x79x12	13,7 kg / 0,108 m ³	RAL 630 ●
RD-619 opcional / optional	70x35x8	3 kg / 0.019 m ³	

PIZARRAS TRÍPODE

TRIPOD FLIPCHARTS • FLIPCHART BUSINESS • TABLEAU TRIPODE

[ESP] Pizarra trípode metálica y magnética de gran estabilidad, apta para escritura con rotuladores de borrado en seco. Admite bloc de papel universal. Regulación de altura total. Incluye 1 brazo telescópico. Fácil montaje

[ENG] Magnetic metal tripod flipchart for writing with dry-wipe markers. Takes universal paper block. Height-adjustable. Includes 1 telescopic arm. Easy to assemble.

[DE] Dreibein-Flipchart aus Metall, magnethaftend und trocken abwischbar zu beschreiben. Für marktübliche Flipchart-Papierblöcke. Höhenverstellbar. Mit seitlich einsteckbarem Konzepthalter. Einfach aufzubauen.

[FR] Tableau trípode métallique, magnétique, pour écriture au marqueur effaçable à sec. Peut recevoir bloc de papier universel. Réglable en hauteur. Inclut un bras télescopique. Facile à monter.



Superficie para rotuladores de borrado en seco.
No limpiar con alcohol o productos abrasivos.

Dry wipe surface. Never clean it with alcohol or abrasive products.

Bitte niemals mit reinem Alkohol reinigen und keine Tücher mit abrasiven Eigenschaften verwenden.

Surface effaçable à sec. Ne nettoyer jamais la surface avec de l'alcool ou un produit abrasif.



Incluye un rotulador
Marker included



Sistema bloc de papel universal / universal paper block system

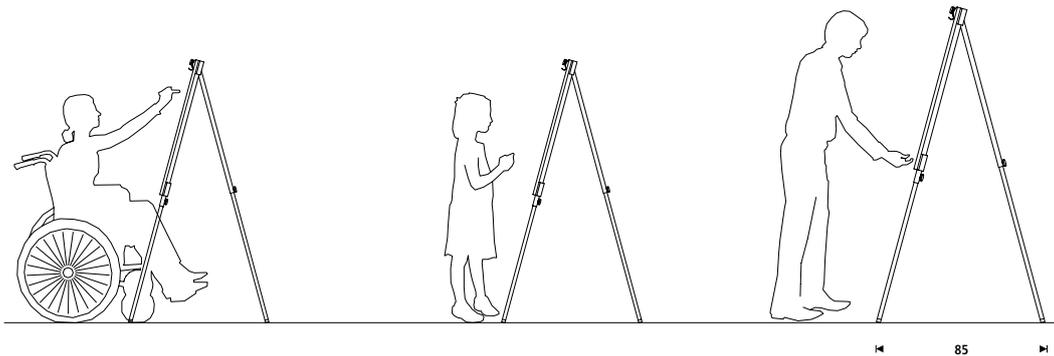

Medidas / Sizes (cm)

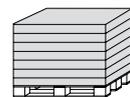
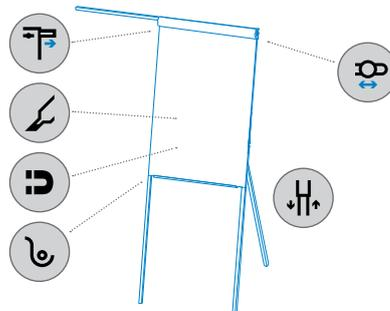
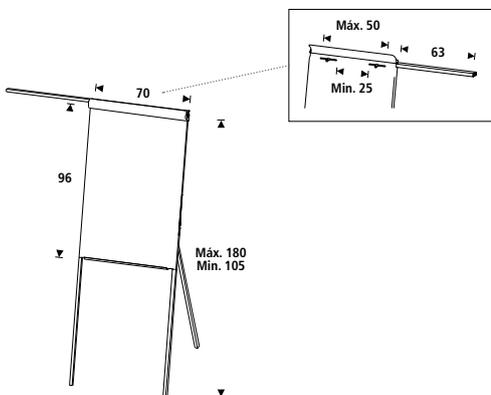

RD-610V19 - palet / pallet 30 u. - 80x120x170 cm

Ref.	cm (embalaje / packaging)	kg / m ³ (embalaje / packaging)	Color
RD-610V19	102x72x4	13,30 kg / 0,030 m ³	blanco / white ○
RD-610V19-630*	102x72x4	13,30 kg / 0,030 m ³	RAL 630 ●

PIZARRAS TRÍPODE

TRIPOD FLIPCHARTS • FLIPCHART BUSINESS • TABLEAU TRIPODE

[ESP] Pizarra trípode de melamina de gran estabilidad, apta para escritura con rotuladores de borrado en seco. Admite bloc de papel. Regulación de altura total facilitando la escritura a niños o personas con movilidad reducida. Fácil montaje.

[ENG] Tripod Flipchart with metallic structure and melamine dry-wipe surface, height adjustable, easy assembly.

[DE] Economy – Flipchart-Stativ mit melaminbeschichteter Oberfläche und Standardblockhalter. Einfache Montage.

[FR] Tableau mélaminé, trois pieds, non aimanté, pour écriture avec feutres. Réglable en hauteur. Pas de bras télescopique. Montage facile.



Superficie para rotuladores de borrado en seco.
No limpiar con alcohol o productos abrasivos.
Dry wipe surface. Never clean it with alcohol or abrasive products.
Bitte niemals mit reinem Alkohol reinigen und keine Tücher mit abrasiven Eigenschaften verwenden.
Surface effaçable à sec. Ne nettoyer jamais la surface avec de l'alcool ou un produit abrasif.



1A01424
Versión montada disponible
Assembled version available



Incluye un rotulador
Marker included



Pinza y bandeja - Paper clamp and pen tray

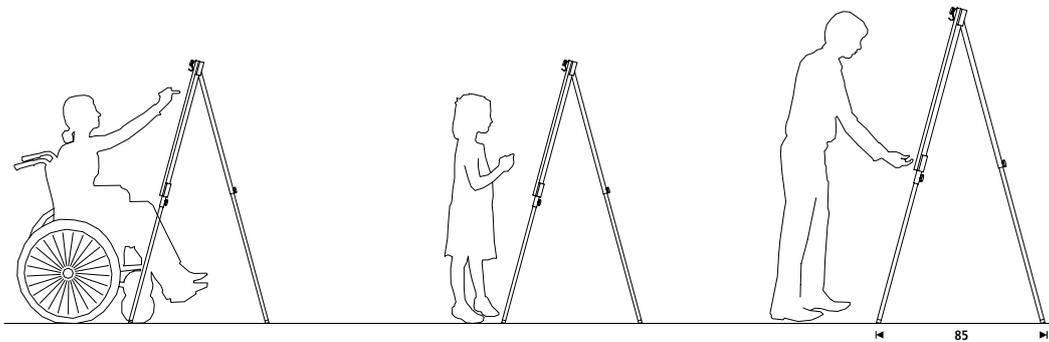

Medidas / Sizes (cm)

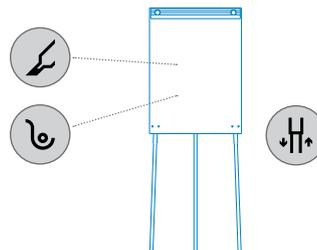
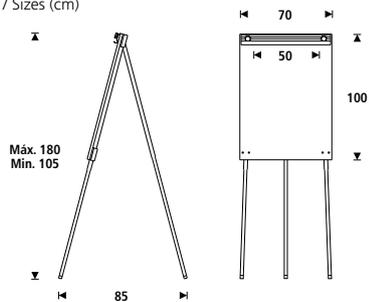

RD-600 - palet / pallet 20 u. - 80x120x120 cm
 1A01424 - palet / pallet 10 u. - 80x120x120 cm

Ref.	cm (embalaje / packaging)	kg / m ³ (embalaje / packaging)
RD-600	104x73x5	11,20 kg / 0,037 m ³
1A01424 - montada / assembled	110x75x9	11,20 kg / 0,074 m ³

VITRINA INTERIOR / INDOOR

DISPLAY CABINET • SCHAUKASTEN INNENBEREICH (WHITEBOARD) • VITRINE

[ESP] Vitrina realizada en aluminio extruido, ligera y de fácil instalación. Superficie magnética lacada en blanco (apta para rotuladores de borrado en seco). Puertas correderas fabricadas en cristal de seguridad, ideal para espacios reducidos. Trasera adicional de acero cincado. Se suministra con cerradura y 2 llaves universales. Incluye accesorios para la fijación a la pared. Profundidad útil 18,6mm. Profundidad total 46mm.

[ENG] Display cabinet made in extruded aluminium, light and easy to install, with lacquered (dry-wipe) metal surface. With sliding doors of ESG glass, ideal for small spaces. Zink steel extra backing. Supplied with 2 universal keys and accessories for wall fixing. Usable depth 18.6 mm. Total depth 46 mm.

[DE] Schaukasten aus stranggepresstem Aluminium mit lackierter, magnethaftender Aushangfläche. Dank leichter Bauweise einfach zu montieren. Mit 5mm dicken ESG-Schiebetüren, abschliessbar. 2 Universalschlüssel und Zubehör für die Wandmontage im Lieferumfang enthalten. Nutztiefe 18,6 mm, Gesamttiefe 46 mm.

[FR] Vitrine réalisée en aluminium extrudé, légère et facile à installer. Surface magnétique laquée en blanc (marqueurs appropriés pour effaçable à sec). Portes coulissantes en verre securit, idéal pour espaces réduits. Arrière supplémentaire d'acier galvanisé. Livrée avec 2 clés universelles. Accessoires pour le montage mural inclus. Profondeur utile 18,6mm. Profondeur totale 46mm.

**MEJORADA
IMPROVED**

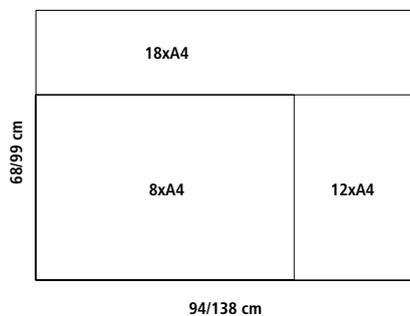
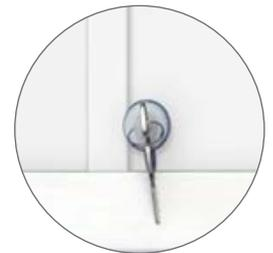
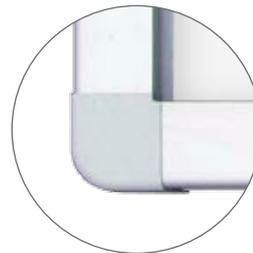
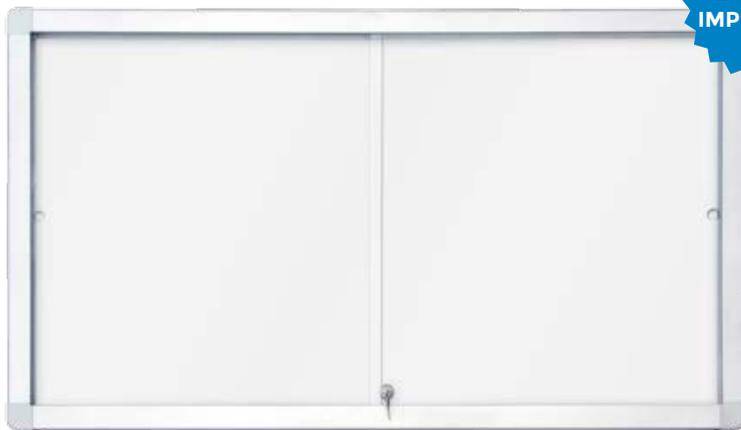

Ref.	cm (embalaje / packaging)	kg / m ³ (embalaje / packaging)
RD-3641V17 (94x68 cm) (8xA4)	100x74x8	13,50 kg / 0,055 m ³
RD-3642V17 (138x68 cm) (12xA4)	145x74x8	20,00 kg / 0,080 m ³
RD-3644V17 (138x99 cm) (18xA4)	145x105x8	27,60 kg / 0,114 m ³

VITRINA INTERIOR / INDOOR

DISPLAY CABINET • SCHAUKASTEN INNENBEREICH (CORK-PINNBOARD) • VITRINE

[ESP] Vitrina realizada en aluminio extruido, ligera y de fácil instalación. Superficie de corcho natural resistente y autorregenerable. Puertas correderas fabricadas en cristal de seguridad, ideal para espacios reducidos. Trasera adicional de acero cincado. Se suministra con cerradura y 2 llaves universales. Incluye accesorios para la fijación a la pared. Profundidad útil 18.6mm. Profundidad total 46mm.

[ENG] Display cabinet made in extruded aluminium, light and easy to install, with cork surface. With sliding doors of ESG glass, ideal for small spaces. Zinc steel extra backing. Supplied with 2 universal keys and accessories for wall fixing. Usable depth 18.6 mm. Total depth 46 mm.

[DE] Schaukasten aus stranggepresstem Aluminium mit Aushangfläche aus Kork. Dank leichter Bauweise einfach zu montieren. Mit 5mm dicken ESG-Schiebetüren, abschliessbar. 2 Universalschlüssel und Zubehör für die Wandmontage im Lieferumfang enthalten. Nutztiefe 18,6mm, Gesamttiefe 46 mm.

[FR] Vitrine réalisée en aluminium extrudé, légère et facile à installer. Surface en liège. Portes coulissantes en verre securit, idéal pour espaces réduits. Arrière supplémentaire d'acier galvanisé. Livrée avec 2 clés universelles. Accessoires pour le montage mural inclus. Profondeur utile 18,6mm. Profondeur totale 46mm.

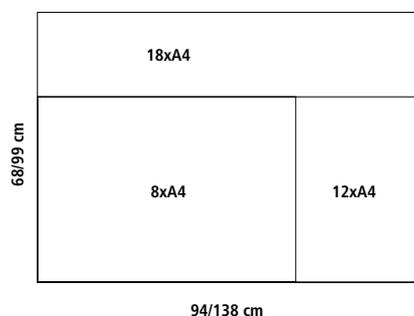

Ref.	cm (embalaje / packaging)	kg / m ³ (embalaje / packaging)
RD-3651V17 (94x68 cm) (8xA4)	100x74x8	13,50 kg / 0,055 m ³
RD-3652V17 (138x68 cm) (12xA4)	145x74x8	18,50 kg / 0,080 m ³
RD-3654V17 (138x99 cm) (18xA4)	145x105x8	25,20 kg / 0,114 m ³

VITRINA INTERIOR / INDOOR

DISPLAY CABINET • SCHAUkastEN INNENBEREICH (PINNBOARD) • VITRINE

[ESP] Vitrina realizada en aluminio extruido, ligera y de fácil instalación. Superficie tapizada. Puertas correderas fabricadas en cristal de seguridad, ideal para espacios reducidos. Trasera adicional de acero cincado. Se suministra con cerradura y 2 llaves universales. Incluye accesorios para la fijación a la pared. Profundidad útil 18,6mm. Profundidad total 46mm.

[ENG] Display cabinet made in extruded aluminium, light and easy to install, with upholstered surface. With sliding doors of ESG glass, ideal for small spaces. Zinc steel extra backing. Supplied with 2 universal keys and accessories for wall fixing. Usable depth 18.6 mm. Total depth 46 mm.

[DE] Schaukasten aus stranggepresstem Aluminium mit stoffbezogener Aushangfläche. Dank leichter Bauweise einfach zu montieren. Mit 5mm dicken ESG-Schiebetüren, abschliessbar. 2 Universalschlüssel und Zubehör für die Wandmontage im Lieferumfang enthalten. Nutztiefe 18,6 mm. Gesamttiefe 46 mm.

[FR] Vitrine réalisée en aluminium extrudé, légère et facile à installer. Surface tapissée. Portes coulissantes en verre securit, idéal pour espaces réduits. Arrière supplémentaire d'acier galvanisé. Livrée avec 2 clés universelles. Accessoires pour le montage mural inclus. Profondeur utile 18,6mm. Profondeur totale 46mm.

MEJORADA
IMPROVED

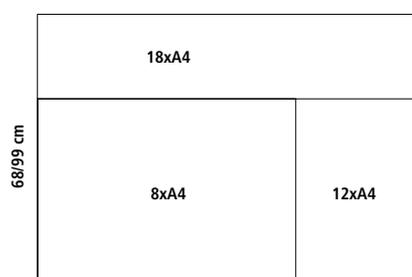

94/138 cm



Ref.	cm (embalaje / packaging)	kg / m ³ (embalaje / packaging)
RD-3661V17 (94x68 cm) (8xA4)	100x74x8	13,50 kg / 0,055 m ³
RD-3662V17 (138x68 cm) (12xA4)	145x74x8	18,50 kg / 0,080 m ³
RD-3664V17 (138x99 cm) (18xA4)	145x105x8	25,20 kg / 0,114 m ³

VITRINA INTERIOR / INDOOR

DISPLAY CABINET • AUSHANG-VITIRINE (WHITEBOARD) FÜR INNENBEREICH) • VITRINE

[ESP] Vitrina realizada en aluminio extruido, ligera y de fácil instalación con marco reforzado. Superficie magnética lacada en blanco (apta para rotuladores de borrado en seco). Puerta batiente fabricada en policarbonato de alta visibilidad. Trasera adicional de acero cincado. Se suministra con cerradura mediante 2 tornillos allen. Incluye accesorios para la fijación a la pared. Profundidad útil 12mm. Profundidad total 38 mm.



[ENG] Display cabinet made in extruded aluminium, light and easy to install, with lacquered (dry-wipe) metal surface. With casement-opening doors of polycarbonate. Zink steel extra backing. Supplied with 2 allen keys and accessories for wall fixing. Usable depth 12 mm. Total depth 38 mm.

[DE] Funktionelle Whiteboard-Vitrine. Mit horizontal öffnender Kunststoffglastür (Innenanwendung). Rahmen aus stranggepresstem Aluminium mit Kunststoffverbindern. Lackierte, magnetisierende Metallinnenfläche. 2 Universalschlüssel und Zubehör für die Wandmontage im Lieferumfang enthalten. Nutztiefe 12 mm. Gesamttiefe 38 mm.

[FR] Vitrine réalisée en aluminium extrudé, légère et facile à installer. Surface magnétique laqué en blanc (marqueurs appropriés pour effaçable à sec). Porte battante en polycarbonate haute visibilité dos en acier galvanisé. Accessoires pour le montage mural inclus. Profondeur utile 12mm. Profondeur totale 38mm.



Marco reforzado
Enhanced frame

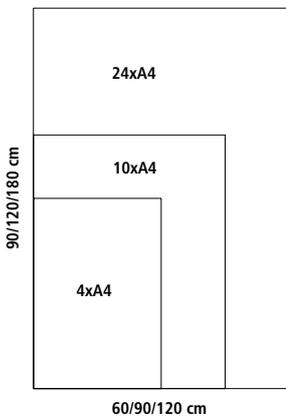

Ref.	cm (embalaje / packaging)	kg / m ³ (embalaje / packaging)
RD-3676V17 (90x60 cm) (4xA4)	96x66x8	9,60 kg / 0,047 m ³
RD-3679V17 (120x90 cm) (10xA4)	126x96x8	16,00 kg / 0,090 m ³
RD-3680V17 (180x120 cm) (24xA4)	189x126x8	30,00 kg / 0,178 m ³

VITRINA INTERIOR / INDOOR

DISPLAY CABINET

AUSHANG-VITIRINE (KORK-PINNBOARD) FÜR INNENBEREICH • VITRINE

[ESP] Vitrina realizada en aluminio extruido, ligera y de fácil instalación con marco reforzado. Superficie de corcho natural resistente y autorregenerable. Puerta batiente fabricada en policarbonato de alta visibilidad. Trasera adicional de acero cincado. Se suministra con cerradura mediante 2 tornillos allen. Incluye accesorios para la fijación a la pared. Profundidad útil 12mm. Profundidad total 38 mm.



[ENG] Display cabinet made in extruded aluminium, light and easy to install, with cork surface. With casement-opening doors of polycarbonate. Zinc steel extra backing. Supplied with 2 allen keys and accessories for wall fixing. Usable depth 12 mm. Total depth 38 mm.

[DE] Funktionelle Korkboard-Vitrine. Mit horizontal öffnender Kunststoffglastür (Innenanwendung). Rahmen aus stranggepresstem Aluminium mit Kunststoffverbindern. Aushangfläche aus Kork. 2 Universalschlüssel und Zubehör für die Wandmontage im Lieferumfang enthalten. Nutztiefe 12 mm. Gesamttiefe 38 mm.

[FR] Vitrine réalisée en aluminium extrudé, légère et facile à installer. Surface en liège. Porte battante en polycarbonate haute visibilité. Arrière supplémentaire d'acier galvanisé. Accessoires pour le montage mural inclus. Profondeur utile 12mm. Profondeur totale 38mm.

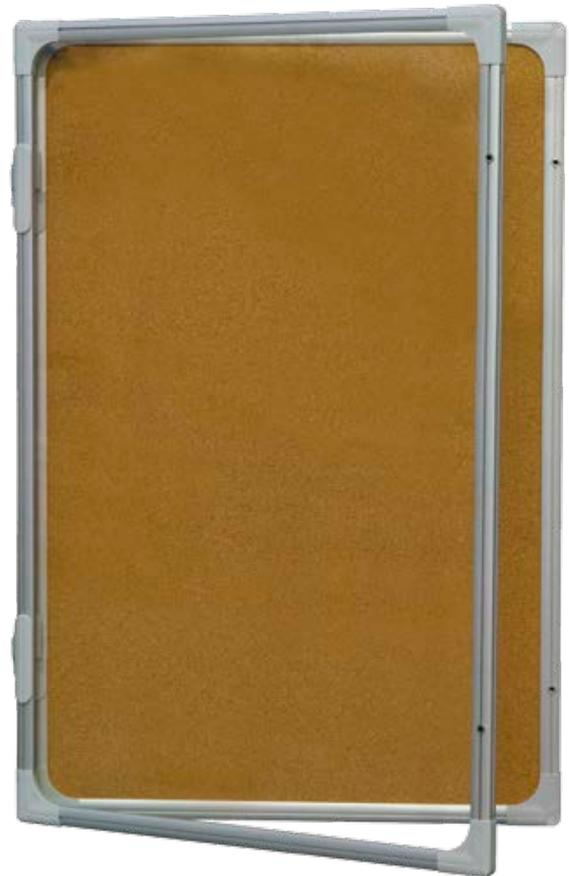

Marco reforzado
Enhanced frame

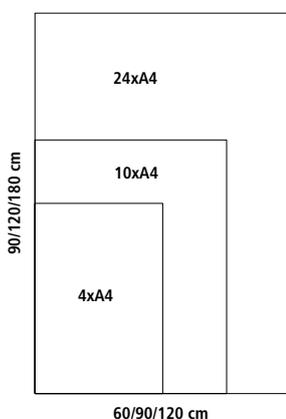

Ref.	cm (embalaje / packaging)	kg / m ³ (embalaje / packaging)
RD-3686V17 (90x60 cm) (4xA4)	96x66x8	7,40 kg / 0,047 m ³
RD-3689V17 (120x90 cm) (10xA4)	126x96x8	12,80 kg / 0,090 m ³
RD-3690V17 (180x120 cm) (24xA4)	189x126x8	27,00 kg / 0,178 m ³

VITRINA INTERIOR / INDOOR

DISPLAY CABINET

AUSHANG-VITIRINE (PINNBOARD) FÜR INNENBEREICH • VITRINE

[ESP] Vitrina realizada en aluminio extruido, ligera y de fácil instalación con marco reforzado. Superficie tapizada. Puerta batiente fabricada en policarbonato de alta visibilidad. Trasera adicional de acero cincado. Se suministra con cerradura mediante 2 tornillos allen. Incluye accesorios para la fijación a la pared. Profundidad útil 12mm. Profundidad total 38 mm.

[ENG] Display cabinet made in extruded aluminium, light and easy to install, with upholstered surface. With casement-opening doors of polycarbonate. Zink steel extra backing. Supplied with 2 allen keys and accessories for wall fixing. Usable depth 12 mm. Total depth 38 mm.

[DE] Funktionelle Pinnboard-Vitrine. Mit horizontal öffnender Kunststoffglastür (Innenanwendung). Rahmen aus stranggepresstem Aluminium mit Kunststoffverbindern. Aushangfläche aus blauem Stoff. 2 Universalschlüssel und Zubehör für die Wandmontage im Lieferumfang enthalten. Nutztiefe 12 mm. Gesamttiefe 38 mm.

[FR] Vitrine réalisée en aluminium extrudé, légère et facile à installer. Surface tapissée. Porte battante en polycarbonate haute visibilité. Dos en acier galvanisé. Accessoires pour le montage mural inclus. Profondeur utile 12mm. Profondeur totale 38mm.



Marco reforzado
Enhanced frame

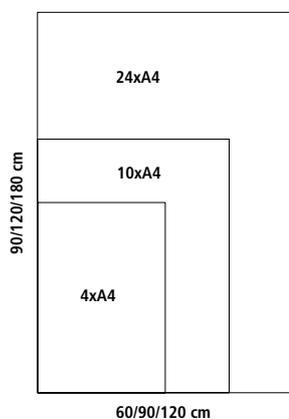
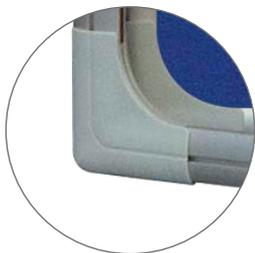

Ref.	cm (embalaje / packaging)	kg / m ³ (embalaje / packaging)
RD-3696V17 (90x60 cm) (4xA4)	96x66x8	8,00 kg / 0,047 m ³
RD-3699V17 (120x90 cm) (10xA4)	126x96x8	14,00 kg / 0,090 m ³
RD-3700V17 (180x120 cm) (24xA4)	189x126x8	27,00 kg / 0,178 m ³

VITRINA INTERIOR / EXTERIOR INDOOR/OUTDOOR

DISPLAY CABINET • SCHAUKASTEN AUSSENBEREICH (WHITEBOARD) • VITRINE

[ESP] Vitrina realizada en aluminio extruido, ligera y de fácil instalación con marco reforzado. Superficie magnética lacada en blanco (apta para rotuladores de borrado en seco). Puerta abatible de apertura vertical en policarbonato de alta visibilidad, ideal para espacios reducidos. Trasera adicional de acero cincado. Se suministra con cerradura y 2 llaves universales. Incluye accesorios para la fijación a la pared. Profundidad útil 24mm. Profundidad total 48 mm.

[ENG] Display cabinet made in extruded aluminium, light and easy to install, with lacquered (dry-wipe) metal surface. With vertical-opening doors of polycarbonate, ideal for small spaces. Zinc steel extra backing. Supplied with 2 universal keys and accessories for wall fixing. Usable depth 24 mm. Total depth 48 mm.

[DE] Außenbereich-geeigneter Schaukasten aus stranggepresstem Aluminium Mit lackierter, magnethaftender Aushangfläche. Vertikal zu öffnende, transparente Kunststoffabdeckung. 2 Universalschlüssel und Zubehör für die Wandmontage im Lieferumfang enthalten. Nutztiefe 24 mm. Gesamttiefe 48 mm.

[FR] Vitrine réalisée en aluminium extrudé, légère et facile à installer. Surface magnétique laquée blanche (marqueurs appropriés pour effaçable à sec). Porte à ouverture vertical en polycarbonate haute visibilité, idéal pour les espaces réduits. Dos en acier galvanisé. Accessoires pour le montage mural inclus. Profondeur utile 24mm. Profondeur totale 48mm.

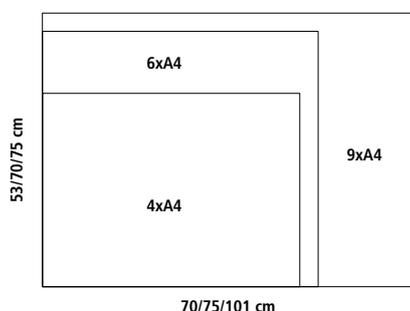

Ref.	cm (embalaje / packaging)	kg / m ³ (embalaje / packaging)
RD-3671V17EX (70x53 cm) (4xA4)	76x59x8	8,80 kg / 0,033 m ³
RD-3672V17EX (75x70 cm) (6xA4)	81x76x8	10,60 kg / 0,046 m ³
RD-3673V17EX (101x75 cm) (9xA4)	107x81x8	18,20 kg / 0,065 m ³

VITRINA INTERIOR / EXTERIOR INDOOR/OUTDOOR

DISPLAY CABINET • SCHAUKASTEN AUSSENBEREICH (KORK-PINNBOARD) • VITRINE

[ESP] Vitrina realizada en aluminio extruido, ligera y de fácil instalación con marco reforzado. Superficie de corcho natural resistente y autorregenerable. Puerta abatible de apertura vertical en policarbonato de alta visibilidad, ideal para espacios reducidos. Trasera adicional de acero cincado. Se suministra con cerradura y 2 llaves universales. Incluye accesorios para la fijación a la pared. Profundidad útil 24mm. Profundidad total 48 mm.

[ENG] Display cabinet made in extruded aluminium, light and easy to install, with cork surface. With vertical-opening doors of polycarbonate, ideal for small spaces. Zinc steel extra backing. Supplied with 2 universal keys and accessories for wall fixing. Usable depth 24 mm. Total depth 48 mm.

[DE] Außenbereich-geeigneter Schaukasten aus stranggepresstem Aluminium Mit Aushangfläche aus Korkmaterial. Vertikal zu öffnende, transparente Kunststoffabdeckung. 2 Universalschlüssel und Zubehör für die Wandmontage im Lieferumfang enthalten. Nutztiefe 24 mm. Gesamttiefe 48 mm.

[FR] Vitrine réalisée en aluminium extrudé, légère et facile à installer. Surface magnétique en liège. Porte à ouverture verticale en polycarbonate haute visibilité, idéal pour les espaces réduits. Dos en acier galvanisé. Accessoires pour le montage mural inclus. Profondeur utile 24mm. Profondeur totale 48mm.

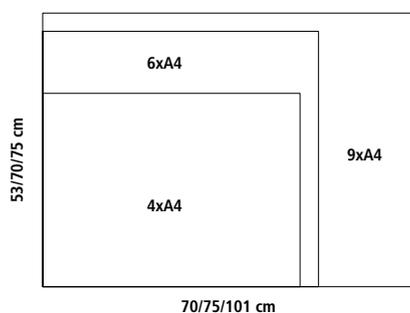
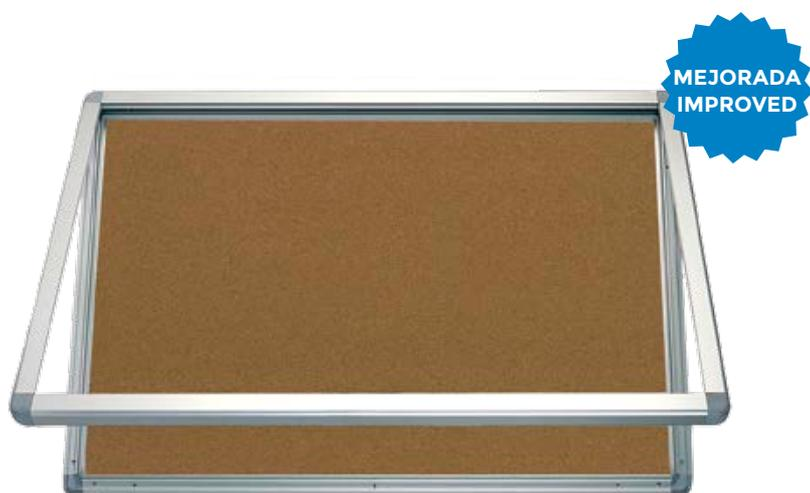

Ref.	cm (embalaje / packaging)	kg / m ³ (embalaje / packaging)
RD-3681V17EX (70x53 cm) (4xA4)	76x59x8	7,40 kg / 0,033 m ³
RD-3682V17EX (75x70 cm) (6xA4)	81x76x8	10,70 kg / 0,046 m ³
RD-3683V17EX (101x75 cm) (9xA4)	107x81x8	14,80 kg / 0,065 m ³

VITRINA INTERIOR / EXTERIOR INDOOR/OUTDOOR

DISPLAY CABINET • SCHAUKASTEN AUSSENBEREICH (PINNBOARD) • VITRINE

[ESP] Vitrina realizada en aluminio extruido, ligera y de fácil instalación con marco reforzado. Superficie tapizada. Puerta abatible de apertura vertical en policarbonato de alta visibilidad, ideal para espacios reducidos. Trasera adicional de acero cincado. Se suministra con cerradura y 2 llaves universales. Incluye accesorios para la fijación a la pared. Profundidad útil 24mm. Profundidad total 48 mm.

[ENG] Display cabinet made in extruded aluminium, light and easy to install, with upholstered surface. With vertical-opening doors of polycarbonate, ideal for small spaces. Zink steel extra backing. Supplied with 2 universal keys and accessories for wall fixing. Usable depth 24 mm. Total depth 48 mm.

[DE] Außenbereich-geeigneter Schaukasten aus stranggepresstem Aluminium Mit Aushangfläche aus blauem Stoff. Vertikal zu öffnende, transparente Kunststoffabdeckung. 2 Universalschlüssel und Zubehör für die Wandmontage im Lieferumfang enthalten. Nutztiefe 24 mm. Gesamttiefe 48 mm.

[FR] Vitrine réalisée en aluminium extrudé, légère et facile à installer. Surface magnétique tapissée. Porte à ouverture vertical en polycarbonate haute visibilité, idéal pour les espaces réduits. Dos en acier galvanisé. Accessoires pour le montage mural inclus. Profondeur utile 24mm. Profondeur totale 48mm.

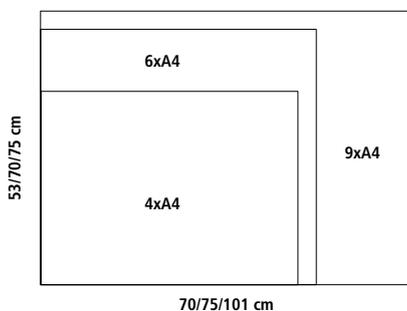

Ref.	cm (embalaje / packaging)	kg / m ³ (embalaje / packaging)
RD-3691V17EX (70x53 cm) (4xA4)	76x59x8	7,80 kg / 0,033 m ³
RD-3692V17EX (75x70 cm) (6xA4)	81x76x8	10,70 kg / 0,046 m ³
RD-3693V17EX (101x75 cm) (9xA4)	107x81x8	14,60 kg / 0,065 m ³

VITRINA CON SOPORTE

DISPLAY CABINET WITH SUPPORT • SCHAUKASTEN MIT STÄNDE DISPLAY CABINET WITH SUPPORT

[ESP] Vitrina realizada en aluminio extruido, ligera y de fácil instalación. Superficie magnética lacada en blanco (apta para rotuladores de borrado en seco), en seco y en corcho según modelo. Puerta batiente en policarbonato de alta visibilidad. Traseira adicional de acero cincado. Se suministra con cerradura y 2 llaves universales. Profundidad útil 24mm. Profundidad total 48 mm. Soporte metálico con base de acero y pie de aluminio extruido para ser utilizado en interior y exterior.

[ENG] Display cabinet made in extruded aluminium, easy to install, with lacquered (dry-wipe) metal surface, metal surface and cork surface. With casement-opening doors of polycarbonate. Zinc steel extra backing. Supplied with 2 universal keys. Useful depth 24 mm. Total depth 48 mm. Metallic support made in steel base and aluminium leg to be used indoor and outdoor.

[DE] Schaukasten aus stranggepresstem Aluminium. Leichte Bauart, einfach zu installieren. Aushangfläche je nach Ausführung weiß lackiert und magnethaftend (geeignet für trocken abwischbare Marker), aus Kork. Helle, horizontal öffnende Kunststofftür (Polycarbonat). Rückseite aus verzinktem Stahl. Abschließbar, 2 Schlüssel im Lieferumfang enthalten. Nutztiefe 24 mm. Gesamttiefe 48 mm. Gestell mit Stahlbasis und Fuß aus stranggepresstem Aluminium, geeignet für Innen- und Außenbereiche.

[FR] Vitrine fabriquée en aluminium extrudé, légère et facile à installer. Surface magnétique laquée en blanc (apte pour les marqueurs effaçables à sec), ou en liège, selon modèle. Porte battante en polycarbonate de grande visibilité. Dos en acier galvanisé. Livrée avec serrure et 2 clés universelles. Profondeur utile 24 mm. Profondeur totale 48 mm. Support métallique avec base en acier et pied en aluminium extrudé, pour une utilisation à l'intérieur ou à l'extérieur.



RD-3630-LC4

Superficie lacada
Lacquered surface

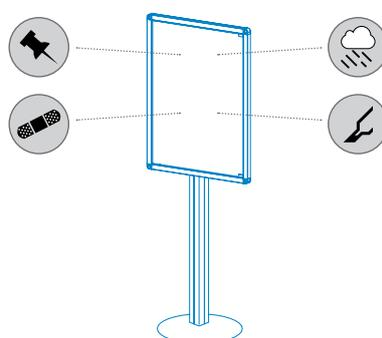
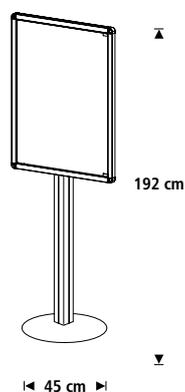

RD-3630-CK4

Superficie de corcho
Cork surface

Ref.	n° (embalaje / packaging)	kg / m ² (embalaje / packaging)
○ RD-3630-LC4 (70x53) (4xA4)	3	7,90 kg / 1,933 m ³
○ RD-3630-LC6 (75x70) (6xA4)	3	11,80 kg / 1,946 m ³
● RD-3630-CK4 (70x53) (4xA4)	3	7,30 kg / 1,933 m ³
● RD-3630-CK6 (75x70) (6xA4)	3	11,80 kg / 1,946 m ³

PANTALLA DE PROYECCIÓN TRÍPODE

TRIPOD SCREEN • STATIV-LEINWAND • ÉCRAN DE PROJECTION AVEC TRÉPIED

[ESP] Pantalla de proyección enrollable, fabricada en tela anti-reflejante con soporte trípode fabricado en aluminio lacado. Posee un brazo para corregir la posición de la imagen. Su estructura es totalmente plegable para facilitar el transporte y almacenamiento. Viene montada.

[ENG] Tripod projection screen fabricated in lacquered aluminium, with antireflective fabric. Incorporates an arm for image projection correction. Totally foldable to facilitate transportation and storage. Comes mounted.

[DE] Leicht zusammenlegbare transportierbare Stativ-leinwand. Außenmaß Projektionsfläche 150x150 cm. Mit Keystone-Bügel. Höhe stufenlos arretierbar.

[FR] Écran de projection enrollable, fabriqué en toile anti-reflet, avec support trépied fabriqué en aluminium laqué. Est équipé d'un bras afin de corriger la position de l'image. Sa structure est entièrement pliable afin de faciliter le transport et le stockage. Livré monté.

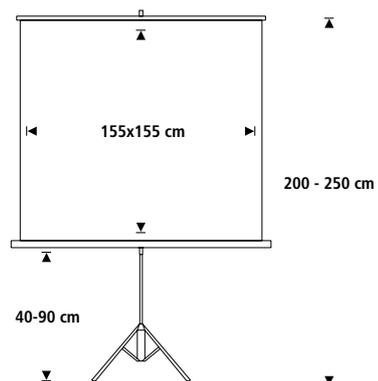

Ref.	cm (embalaje / packaging)	kg / m ³ (embalaje / packaging)
RD-3045	175x15x9	6 kg / 0,022 m ³

PANTALLA DE PROYECCIÓN DE PARED

WALL SCREEN • PROJEKTIONSWAND • ÉCRAN DE PROJECTION SUR MUR

[ESP] Pantalla de proyección enrollable mural, adaptable a techo o pared. Fabricada en tela anti-reflejante. La carcasa está fabricada en aluminio. Enrollado automático. Viene montada.

[ENG] Wall projection screen adaptable for wall and ceiling. Aluminium structure with antireflective fabric. The fabric can be rolled to the required size and the rolling is automatic. Comes mounted.

[DE] Projektionswand 190x143 (4:3) cm für Wand und Deckenmontage. Höhe stufenlos arretierbar.

[FR] Écran de projection enroulable et mural, s'adaptant au plafond ou au mur. Fabriqué en toile anti-reflet. Le boîtier est en aluminium. Enroulement automatique. Livré monté.

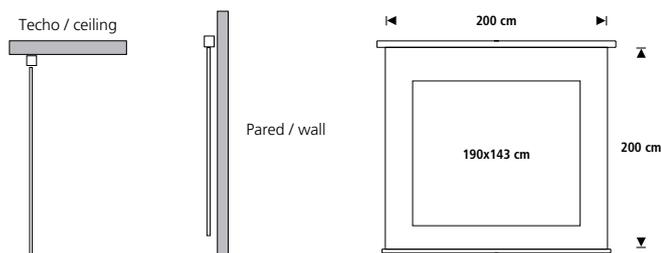
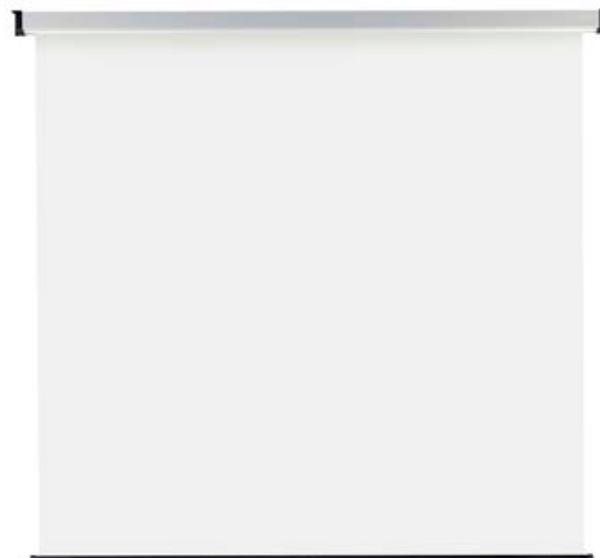

Ref.	cm (embalaje / packaging)	kg / m ³ (embalaje / packaging)
RD-3046	226x12x10	8,16 kg / 0,024 m ³

SOPORTE PROYECTOR PARA TECHO

CEILING PROJECTOR SUPPORT • DECKENHALTERUNG FÜR PROJEKTOR
SUPPORT POUR PROJECTEUR AU PLAFOND

[ESP] Soporte proyector realizado en acero perfecto para todo tipo de proyecciones de larga y corta distancia. Viene montado. Para soportes de ultracorta distancia, consultar Rocada.

[ENG] Steel projector support for all types of long- and short-throw projection. Supplied assembled. For ultra short distance projectors, contact Rocada.

[DE] Universelle Projektor-Deckenhalterung aus Stahl, dreh- und neigbar.

[FR] Support de projecteur réalisé en acier et idéal pour tout type de projection à distance focale courte et longue. Livré monté.

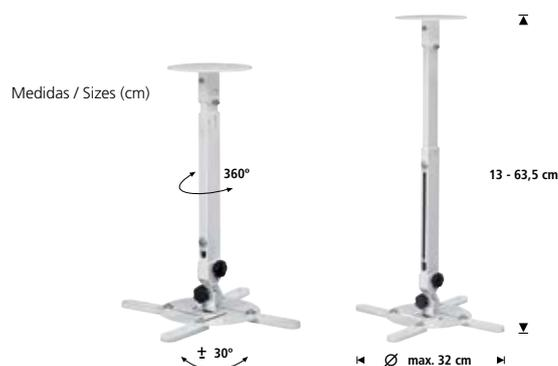

Ref.	cm (embalaje / packaging)	kg / m ³ (embalaje / packaging)
RD-3047	24x27x8	2,45 kg / 0,004 m ³

SEPARADOR MÓVIL

MOBILE DIVIDER • PROSPEKTSTÄNDER • CLOISON MOBILE

[ESP] Separador móvil multifuncional con estructura realizada en acero que permite la fijación de cinco bandejas metálicas RD-8320 por ambos lados. Estructura modular lineal o a 90°. Ruedas de serie con freno.

[ENG] Multifunctional mobile divider with steel structure enabling the attachment of five RD-8320 trays on both sides. Straight modular or 90° structure.

[DE] Mobiles Trägergestell aus pulverbeschichtetem Stahlrohrarmen für die beidseitige Aufnahme von bis zu 5 Metallablagen RD-8320. Verkettungswinkel: 90° und 180°

[FR] Cloison mobile multifonctions avec structure en acier permettant de fixer 5 étagères métalliques RD-8320 de chaque côté. Structure modulaire linéaire ou à 90°.



5 baldas incluidas
5 shelves included

Medidas / Sizes (cm)

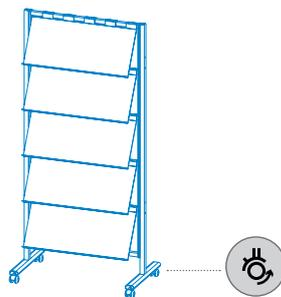
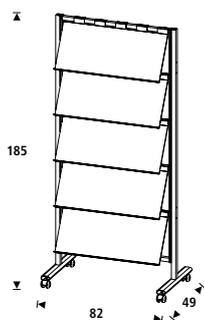

RD-8320 (5u.)

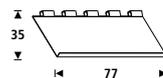

Bandejas adicionales
Additional trays

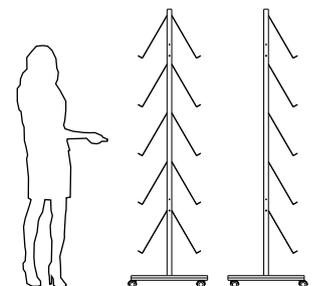

Ref.	n° (embalaje / packaging)	cm (embalaje / packaging)	kg / m³ (embalaje / packaging)
RD-8304 (Complete)	2	(83x192x15) + (80x39x10)	33,60 kg / 0,270 m³
RD-8320 (5u.) opcional / optional	1	80x39x10	5,15 kg / 0,031 m³

REVISTERO DE PARED

MAGAZINE WALL RACK • WANDZEITUNGSHALTER • PORTE-REVUES MURALMOBILE

[ESP] Revistero de pared fabricado en acero. Fijación a pared mediante dos puntos. (3 unidades por caja).

[ENG] Steel magazine wall rack. 2 point wall attachment. (3 units per box).

[DE] Wandhalter für Zeitschriften. Pulverbeschichtetes Stahlblech, 2-Punkt-Befestigung.

[FR] Porte-revues mural en acier. Fixation murale par 2 points.



Medidas / Sizes (cm)

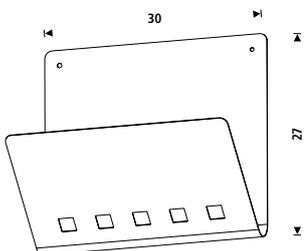

Ref.	cm (embalaje / packaging)	kg / m ³ (embalaje / packaging)
2980 (3 u.)	37x26x23	3,8 kg / 0,022 m ³

SEPARADOR MÓVIL

MOBILE DIVIDER • UNIVERSAL PIN-UND MODERATIONSWAND • CLOISON MOBILE

[ESP] Separador móvil de doble cara de estructura metálica y superficie blanda para chinchetas y notas. Gracias a su resistente superficie absorbe la sonoridad. Ruedas de serie. Permite múltiples combinaciones gracias a la ref. RD-8115.

[ENG] Double face mobile divider of a metallic structure and with a bland surface for pins and notes. Thanks to its resistant surface, it absorbs loudness. Allows multiple combinations thanks to the ref. RD-8115.

[DE] Neuartiges Pinn- und Stellwandwandkonzept mit innovativem und standfestem Rollenfußgestell sowie einem stabilem Metallrahmen. Die Fußform ermöglicht die Anordnung mehrerer Tafeln auch im 90° und 180° Winkel. Feste Verbindung mittels Zubehörset RD 8115. Die Rollen gehören zum Lieferumfang. Die Platte ist beidseitig stoffbespannt, Pinnadeln können leicht eingestochen werden.

[FR] Cloison mobile, structure métal et surface en revêtement spécial pour punaises et notes. Atténuation des bruits grâce au revêtement résistant. Permet de multiples combinaisons, grâce à la réf. RD-8115.

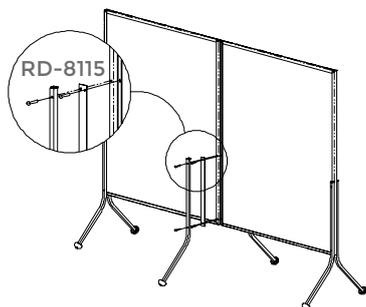

Piezas unión que permiten múltiples configuraciones.
Joining parts that allow multiple configurations.
Verbindungsteile, welche verschiedene Konfigurationen erlauben.
Raccords permettant de multiples configurations.

RD-8100

RD-8100/2

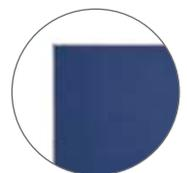
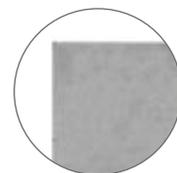

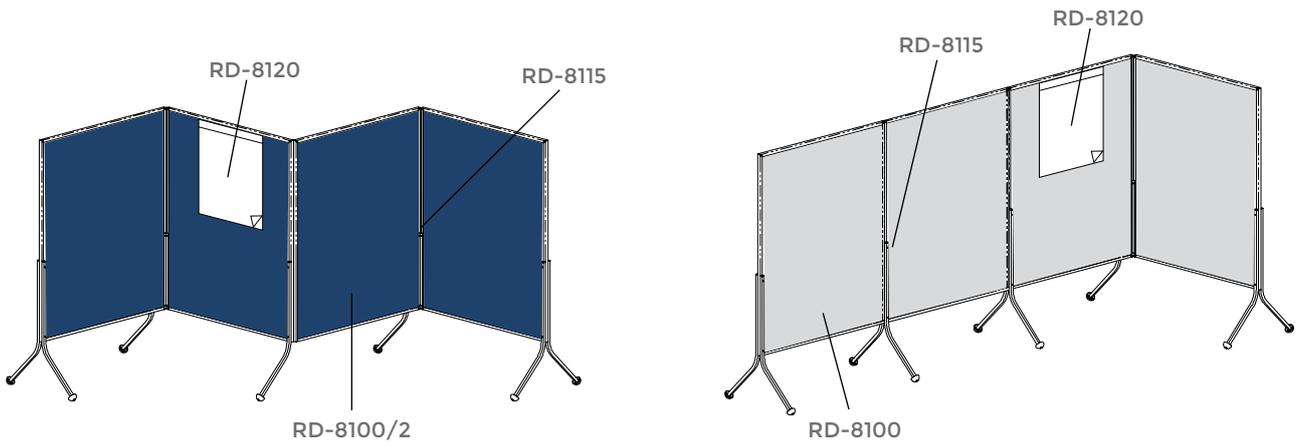

Medidas / Sizes (cm)

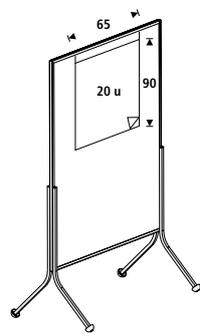
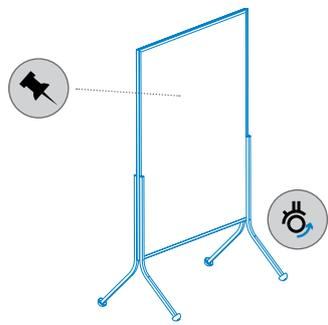
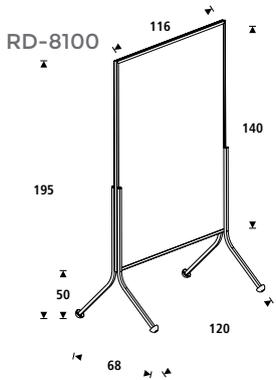

RD-8120
 Bloque de papel 20 hojas 70 gr y sistema de fijación.
 Paper block 20 sheets 70 gr and fixation system.
 Aufsteckbare Flipchartpapier-Halterung für Block mit 20 Blatt Papier.

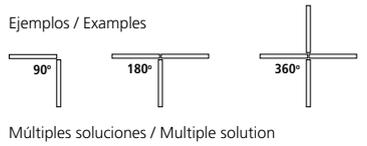

Ref.	cm (embalaje / packaging)	kg / m ³ (embalaje / packaging)
RD-8100	175x123x6	12,1 kg / 0,129 m ³
RD-8100/2	175x123x6	12,1 kg / 0,129 m ³
RD-8115 opcional / optional	54x5x5	2 kg / 0,001 m ³
RD-8120 opcional / optional	87x8x8	1,95 kg / 0,005 m ³

PANEL INFORMATIVO

INFORMATION PANEL • INFOTAFEL • PANNEAU D'INFORMATION

[ESP] Panel informativo metálico de doble cara fabricado en blanco, apto para la escritura con rotulador de borrado en seco. Opcional protector de polímero técnico imantado para proteger la escritura o la fijación de información impresa. Fácil montaje.

[ENG] Metal information panel made in two finishes: in white, suitable for writing with dry-wipe marker, or in black for writing with chalk. Optional magnetic technical polymer protector to protect the writing or the fixing of printed information. Easy to assemble.

[DE] Metall-Infotafel in Weiß zum Beschreiben mit trocken abwischbaren Markern. Einfach aufzubauen.

[FR] Panneau d'information métallique proposé en deux finitions : blanc pour l'écriture au marqueur effaçable à sec ou noir pour l'écriture à la craie. Protecteur en polymère technique aimanté en option afin de protéger l'écriture ou la fixation de l'information imprimée. Facile à monter.

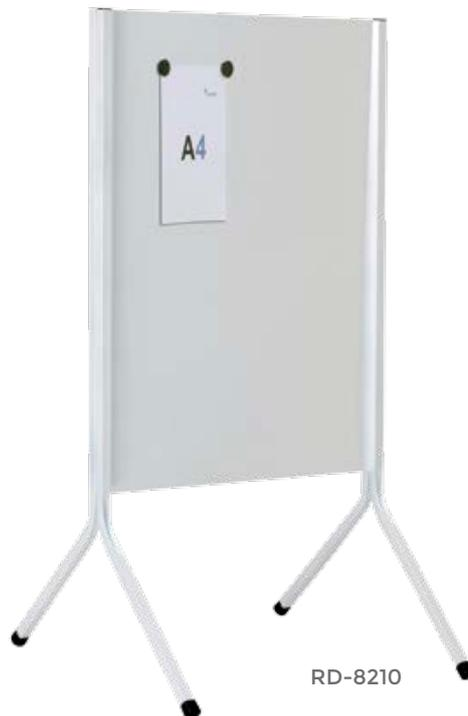

Superficie para rotuladores de borrado en seco.
No limpiar con alcohol o productos abrasivos.
Dry wipe surface. Never clean it with alcohol or abrasive products.
Bitte niemals mit reinem Alkohol reinigen und keine Tücher mit abrasiven Eigenschaften verwenden.
Surface effaçable à sec. Ne nettoyer jamais la surface avec de l'alcool ou un produit abrasif.



Admite rotulador de tiza líquida.
Allows liquid chalk markers

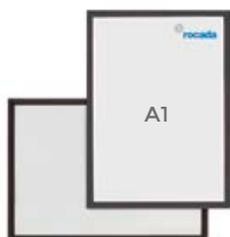

RD-S0301A1
Optional
Optional

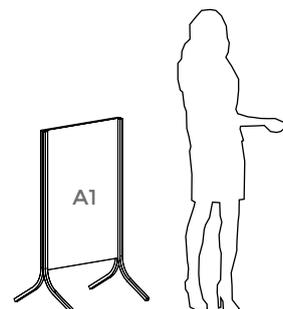

Medidas / Sizes (cm)

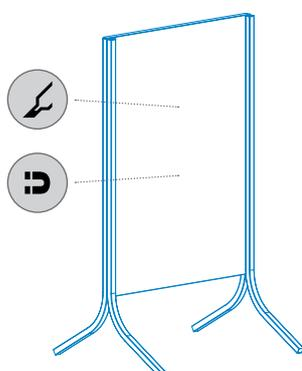
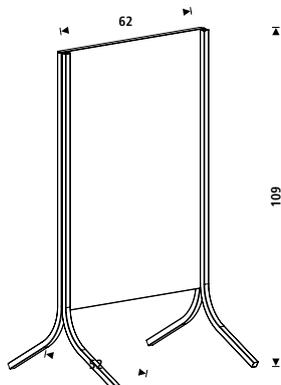

Ref.	cm (embalaje / packaging)	kg / m ³ (embalaje / packaging)
RD-8210 (Blanco / White)	121x67x40	5,75 kg / 0,032 m ³
RD-S0301A1 (1u) opcional / optional	87x63x2	1,00 kg / 0,010 m ³

PANEL INFORMATIVO METÁLICO REGULABLE EN ALTURA

ADJUSTABLE-HEIGHT METAL INFORMATION PANEL • PLAKAT-BODENSTÄNDER • PANNEAU D'INFORMATION MÉTALLIQUE RÉGLABLE EN HAUTEUR

[ESP] Panel informativo metálico regulable en altura con panel rotativo 360°. Superficie metálica para fijar documentos en formato A2, A3 o A4 mediante imanes y pintada en blanco para escribir directamente con rotuladores especiales para pizarra. Fácil montaje.

[ENG] Adjustable-height metal information panel finished in white, suitable for writing with dry-wipe marker. Easy to assemble.

[DE] Höhenverstellbarer Metall-Plakatständer für den Innenbereich. Format-Varianten A2, A3, A4. Die weiße Trägerplatte kann mit Boardmarkern beschriftet werden, alternativ kann ein Papierdokument in eine magnethaftende, transparente Info-Hülle (separat zu bestellen) eingelegt werden. Die Informationsdarstellung kann wahlweise senkrecht oder waagrecht erfolgen. Stabiles Bodengestell aus Metall.

[FR] Panneau d'information métallique réglable en hauteur et proposé en blanc pour l'écriture au marqueur effaçable à sec ou noir pour l'écriture à la craie. Facile à monter.

MEJORADA IMPROVED



Admite rotulador de tiza líquida. Allows liquid chalk markers

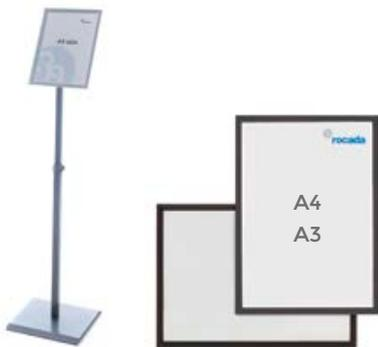
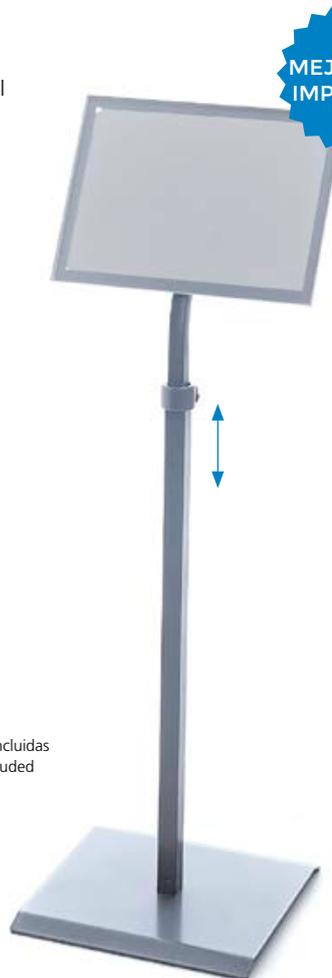

Fundas magnéticas incluidas
Magnetic sleeves included

Medidas / Sizes (cm)

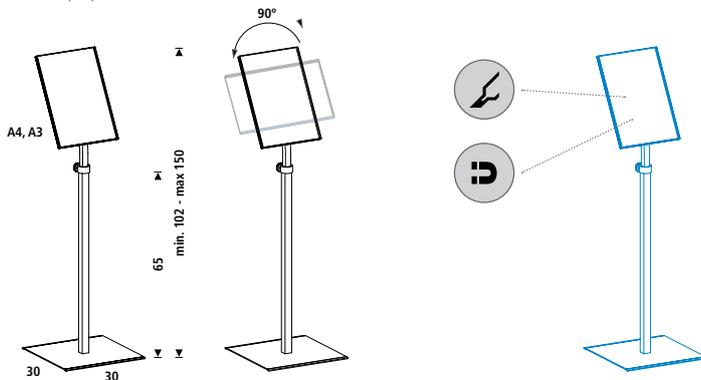

Ref.	cm (embalaje / packaging)	kg / m ³ (embalaje / packaging)
BS07055 A4	80x58x5	4,9 kg / 0,024 m ³
BS07065 A3	80x58x5	5,8 kg / 0,024 m ³

PANEL INFORMATIVO INTERIOR / INDOOR

INFORMATION PANEL • KUNDENSTOPPER • PANNEAU D'INFORMATION

[ESP] Panel informativo tipo Aboard para tiza o rotulador de tiza líquida. Estructura plegable realizada en madera natural acabado color cerezo. Superficie de escritura de color negro en ambas caras. Ideal para restaurantes, bares y comercios en general.

[ENG] A-board informative panel for writing with chalk. Folding structure made in natural wood with cherry colour finish which allows writing on both sides. Black writing surface. Ideal for restaurants, bars and businesses in general.

[DE] Schwarze Schreibfläche, beidseitig mit Kreide feuch abwischbar zu beschreiben. Dekoratives, klappbares Gestell aus Naturholz, Kirschholzfarben lackiert. Ideal für Restaurants, Bars, Cafés...

[FR] Panneau d'information type Aboard pour craie. Structure pliante réalisée en bois naturel finition couleur cerise pour écriture sur les deux faces. Surface d'écriture de couleur noire Idéal pour restaurants, bars, commerces en général.



Admite rotulador de tiza líquida
Allow liquid chalk marker



Medidas / Sizes (cm)

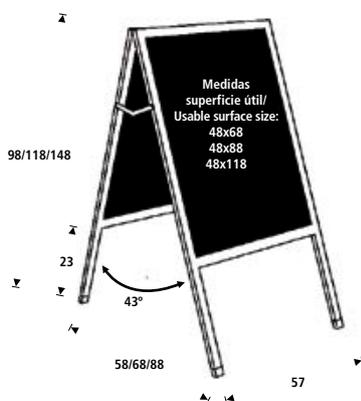

Ref.	cm (embalaje / packaging)	kg / m ³ (embalaje / packaging)
BSA2CH (50x70 cm)	92x66x11	4,80 kg / 0,067 m ³
BSA1CH (50x90 cm)	122x66x11	5,80 kg / 0,089 m ³
BSA0CH (50x120 cm)	152x96x11	10,80 kg / 0,161 m ³

PANEL INFORMATIVO INTERIOR / INDOOR

INFORMATIVE PANEL • KREIDE-WANDTAFEL • PANNEAU

[ESP] Panel informativo de pared para tiza o rotulador de tiza líquida. Estructura realizada en madera natural con acabado en color cerezo. Superficie de escritura de color negro ideal para restaurantes, bares y comercios en general.

[ENG] Informative wall panel for writing with chalk. Structure made in natural wood with cherry colour finish. Black writing surface. Ideal for restaurants, bars and businesses in general.

[DE] Dekorative Wandtafel mit Naturholz-Rahmen, Kirschholzfärbung lackiert. Mit Kreide feucht abwischbar zu beschreiben. Ideal für Restaurants, Bars, Cafés...

[FR] Panneau mural d'information pour craie. Structure réalisée en bois naturel finition couleur cerise. Surface d'écriture de couleur noire. Idéal pour restaurants, bars, commerces en général.

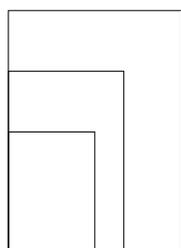

60/90/120 cm

45/60/90 cm



Admite rotulador de tiza líquida
Allow liquid chalk marker

Ref.	cm (embalaje / packaging)	kg / m ³ (embalaje / packaging)
BS0720 (60x45 cm)	72x47x3	2,20 kg / 0,008 m ³
BS0721 (90x60 cm)	103x62x3	3,95 kg / 0,016 m ³
BS0722 (120x90 cm)	133x92x3	7,20 kg / 0,031 m ³

INFORMACIÓN EXTERIOR / OUTDOOR

INFORMATION • INFORMATION • INFORMATION

[ESP] Marcos informativos clip. Cuélguelos en todas las paredes y pasillos de más rotación. Informe y capte clientes nuevos con sus ofertas más sensacionales. Gracias a su sistema clip, permite cambiar la publicidad de forma muy rápida. Marco de aluminio anodizado en plata de limpieza fácil y codos de plástico decorativos. Viene montado.

[ENG] Aluminium snap frames. Hang them up on all (the out) walls and corridors where the majority of the people pass through. Inform the clients and capture new clients with your most sensational offers. Thanks to its clip system, it allows you to rapidly change publicity. Easy cleaning silver anodized aluminium frame with decorative plastic corners. Comes assembled.

[DE] Bilderwechselrahmen. Diese dekorativen „Flachvittrinen“ ermöglichen aufgrund des Klapprahmenprinzips ein einfaches und schnelles Wechseln der Aushänge. Silbereloxiertes Aluminiumprofil, stabile Polystyrol-Rückwand und Antireflex-Schutzfolie. Nur für Wandmontage geeignet.

[FR] Cadre clip mural en aluminium. Informez les clients et captez l'attention de nouveaux clients avec vos informations importantes. Grâce au système clip, permet de changer l'information rapidement. Cadre aluminium anodisé argent. Entretien facile, coins décoratifs en plastique.

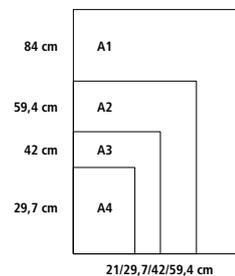

Ref.	cm (embalaje / packaging)	kg / m ³ (embalaje / packaging)
BS0701 (DINA4 21x29,7 cm)	34x25x2	0,5 kg / 0,002 m ³
BS0702 (DINA3 29,7x42 cm)	46x34x2	0,7 kg / 0,003 m ³
BS0703 (DINA2 42x59,4 cm)	64x46x2	1,45 kg / 0,005 m ³
BS0704 (DINA1 59,4x84 cm)	101x64x3	2,75 kg / 0,016 m ³

POSTE DE CINTA RETRÁCTIL

RETRACTABLE QUEUE GUIDES • METALLISCHER ABSPERRPFOSTEN
 POTEAU GUIDE-FILES A SANGLE RÉTRACTILE

[ESP] Poste metálico con 2m de cinta flexible acabado en negro. Las cintas se pueden personalizar bajo pedido.

[ENG] Freestanding solutions with 2m flexi belts in black finish. The belts can be branded with logos or messages as required.

[DE] Selbstspannender Absperrständer mit Gurtsystem. Verfügbar in verschiedenen Farben. Auf Wunsch können die Gurte mit Ihrem Logo bedruckt werden.

[FR] Barrière tendue avec la ceinture flexible en noir. Les ceintures peuvent être marqués selon vos souhaits.



Para colores especiales consultar Rocada.
 For special colours contact Rocada.



Medidas / Sizes (cm)

BS077=S

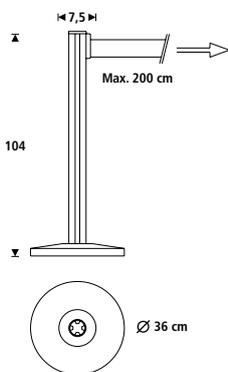

BS0771S

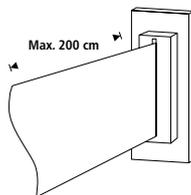

BS0771S

Terminal de pared opcional
 Optional wall terminal



Ref.	cm (embalaje / packaging)	kg / m ³ (embalaje / packaging)
BS0770S (2u.)	105x55x12	23 kg / 0,069 m ³
BS0771S opcional / optional	10x10x10	0,1 kg / 0,001 m ³

EXPOSITORES

DISPLAY SYSTEMS • PROSPEKTSTÄNDER • PRÉSENTOIRS

[ESP] Expositores de sobremesa de metacrilato para tamaño DIN A3, A4, A5 y 1/3 de A4 con diferentes funciones para transmitir la información adecuada a cada necesidad.

[ENG] Plexiglas tabletop display systems for sizes DIN A3, A4, A5 and 1/3 A4 with various functions for transmitting the right information when necessary.

[DE] Infoständer aus Methacrylat, für unterschiedliche Papierformate erhältlich.

[FR] Présentoirs de table en méthacrylate pour dimension DIN A3, A4, A5 et 1/3 de A4 avec différentes fonctions pour apporter l'information adaptée à chaque besoin.



RD-3813
Portatarjetas individual
Individual card holders
Visitenkartenhalter (Einzelformat)
Porte carte individuel

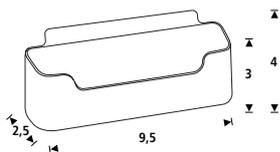

Modelo forma L
L form model



Modelo forma T
T form model

Medidas / Sizes (cm)

Modelo forma L / L form model

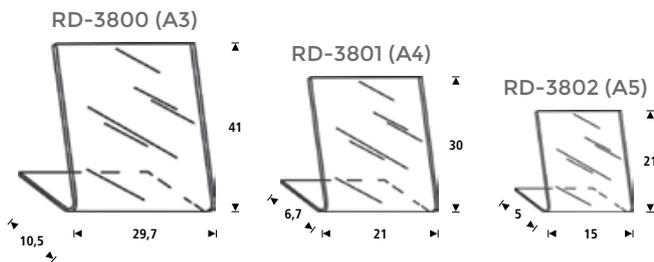

Modelo forma T / T form model

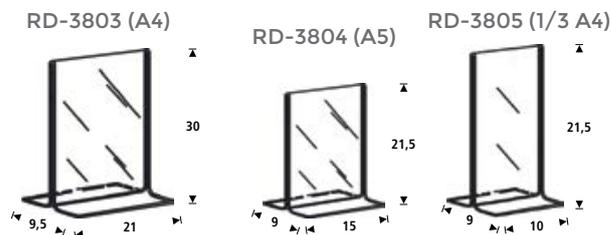

Ref.	u.	cm (embalaje / packaging)	kg / m ³ (embalaje / packaging)
RD-3800 (A3)	Caja 6 u. / Box 6 u.	48x16x33	5 kg / 0,024 m ³
RD-3801 (A4)	Caja 12 u. / Box 12 u.	39x12x24	3,1 kg / 0,011 m ³
RD-3802 (A5)	Caja 12 u. / Box 12 u.	30x11x18	1,6 kg / 0,005 m ³
RD-3803 (A4)	Caja 12 u. / Box 12 u.	41x35x25	3,7 kg / 0,035 m ³
RD-3804 (A5)	Caja 12 u. / Box 12 u.	38x25x18	2 kg / 0,016 m ³
RD-3805 (1/3 A4)	Caja 12 u. / Box 12 u.	37x25x13	1,4 kg / 0,011 m ³
RD-3813	Caja 24 u. / Box 24 u.	23x11x24	0,8 kg / 0,004 m ³

EXPOSITORES

DISPLAY SYSTEMS • PROSPEKTSTÄNDER • PRÉSENTOIRS

[ESP] Expositores de sobremesa o pared de metacrilato para tamaño A4, A5 y 1/3 de A4 con diferentes funciones para transmitir la información adecuada a cada necesidad.

[ENG] Plexiglas tabletop or wall display systems for sizes A4, A5 and 1/3 A4 with various functions for transmitting the right information when necessary.

[DE] Prospektständer aus Methacrylat, für unterschiedliche Formate erhältlich

[FR] Présentoirs de table en méthacrylate pour dimension A4, A5 et 1/3 de A4 avec différentes fonctions pour apporter l'information adaptée à chaque besoin.



Medidas / Sizes (cm)

RD-3806 (A4)

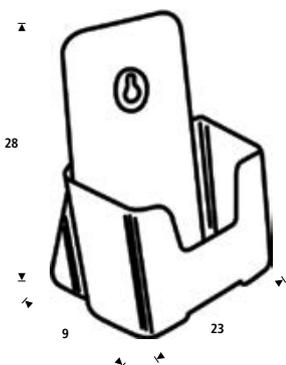

RD-3807 (A5)

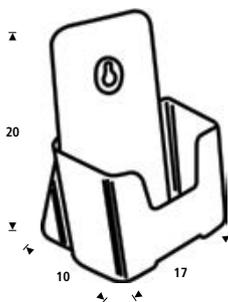

RD-3808 (1/3 A4)

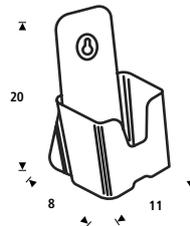

Ref.	u.	cm (embalaje / packaging)	kg / m ³ (embalaje / packaging)
RD-3806 (A4)	Caja 7 u. / Box 7 u.	41x26x30	2,4 kg / 0,031 m ³
RD-3807 (A5)	Caja 8 u. / Box 8 u.	36x25x22	1,7 kg / 0,018 m ³
RD-3808 (1/3 A4)	Caja 18 u. / Box 18 u.	36x28x22	2,3 kg / 0,021 m ³

SOPORTE DE SOBREMESA PARA PANTALLA PLANA

DESK SUPPORT FOR FLAT SCREEN • MONITORHALTER
SUPPORT SUR TABLE POUR ÉCRAN PLAT

[ESP] Soporte monitor de acero de sobremesa con movimiento de rotación 90° y de giro completo 360° para pantallas LCD-TFT 14"-22". viene montado.

[ENG] Aluminium support with inclination movement, rotating, which permits adaptation for screen of 10" to 24". Comes mounted.

[DE] Monitorhalter für den Schreibtisch. Schwenkbar. Rotation 90 ° und volle Drehung 360 ° für LCD-Flachbildschirme-/TFT 14 "- 22 ". Es ist montiert.

[FR] Support d'ordinateur en acier, avec inclinaison à 90 ° et rotation complète à 360 ° pour écran 14 à 22 pouces LCD-TFT. Livré

NEW

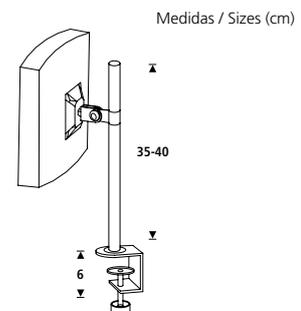
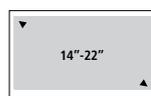
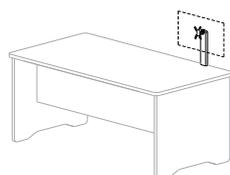

Ref.	cm (embalaje / packaging)	kg / m ³ (embalaje / packaging)
RD-2025	51x15x12	1,73 kg / 0,009 m ³

Hasta fin de existencias / Until stock runs out

SOPORTE DE PARED PARA PANTALLA PLANA

WALL SUPPORT FOR FLAT SCREEN • MONITORHALTER
SUPPORT MURAL POUR ÉCRAN PLAT

[ESP] Soporte de aluminio para pared con movimiento de inclinación, giro, panorama y extensión; permite adaptar pantallas de 10" a 47". Viene montado.

[ENG] Aluminium support with inclination movement, rotating panoramic and extendible which permits adaptation for screen of 10" to 47". Comes mounted.

[DE] Monitorhalterung für die Wandmontage. Schwenkbar. Für Flachbildschirme von 10 bis 47 Zoll.

[FR] Support mural en aluminium avec mouvement d'inclinaison, rotation, vision panoramique et extension, s'adaptant aux écrans de 10" à 47". Livré monté.



Medidas / Sizes (cm)

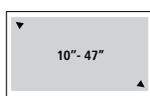
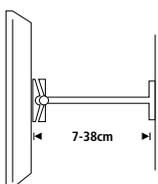

Ref.	cm (embalaje / packaging)	kg / m ³ (embalaje / packaging)
RD-2026	36x27x6	3,45 kg / 0.005 m ³

HOT DESK

[ESP] Mueble multifuncional realizado en melamina de 19mm, diseñado para dar solución a las nuevas necesidades en los puestos de trabajo móviles. Este nuevo concepto de mueble permite tener un puesto de trabajo móvil y completo, en el que se puede almacenar y transportar todo lo que uno necesita para el trabajo diario. Equipado con baldas y cajones según modelo, bandeja extraíble para elementos informáticos, paso de cables, portaetiquetas y puerta metálica con cerradura. Bandeja superior abatible 15°. Para videoproyecciones / presentaciones.

[ENG] Multifunctional unit made in 19 mm melamine designed to satisfy the new needs in workstations. This new concept unit makes it possible to have a complete mobile workstation for storing and transporting everything needed for everyday work. Equipped with shelves and drawers, according to the model, pull-out tray for IT devices, cable passage and metal door with lock. Flip cover 15°. For presentation use.

[DE] Multifunktionsmöbel für Mitarbeiter mit flexibler Arbeitsplatznutzung. Der Caddy ermöglicht die individuelle, geordnete Ablage und den Transport aller für die tägliche Arbeit erforderlichen Gegenstände und Unterlagen. Je nach Modell mit Regalen (basic) oder Schublade/Hängeregisterauszug. Kabeldurchführung für Strom- und Netzkabel. Ausziehbare Arbeitsplatte in 72cm Höhe. Abschließbare Metalltür mit 270° Öffnungswinkel. Große, stabile Laufrollen.

[FR] Meuble multifonctionnel réalisé en mélaminé de 19mm conçu pour répondre aux nouveaux besoins sur les postes de travail. Ce nouveau concept de meuble permet de disposer d'un poste de travail mobile, complet où garder et transporter tout ce qui est nécessaire pour le travail quotidien Muni d'étagères et de tiroirs selon le modèle, plateau amovible pour éléments informatiques, passage de câbles et porte métallique avec serrure.



RD-4037



RD-4036





RD-4038

accesorio carpetas 31cm
Accessory folder 31cm length (USA)

Medidas / Sizes (cm)

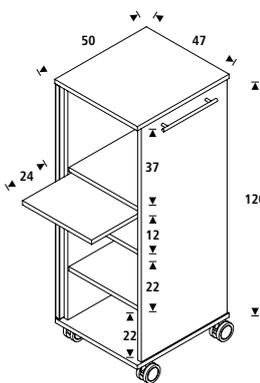

RD-4036

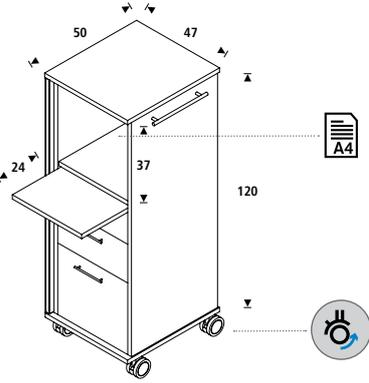

RD-4037

RD-4036/1
RD-4037/1

Vista trasera / Back side

Tapa abatible 15°
Flip cover 15°

Vista lateral / Lateral side



Puerta de metal con cerradura
Metal door with lock

Ref.	cm (embalaje / packaging)	kg / m ³ (embalaje / packaging)
● RD-4036	112x51x46	43,7 kg / 0,262 m ³
● RD-4036/1	112x51x46	43,7 kg / 0,262 m ³
● RD-4037	112x51x46	48,7 kg / 0,262 m ³
● RD-4037/1	112x51x46	48,7 kg / 0,262 m ³
RD-4038 Accesorio carpeta / file accessory (USA)	42x3x3	1kg / 0.001 m ³

Desmontado bajo pedido / Knock-down on request

CARRO MULTIFUNCIONAL

MULTIFUNCTIONAL TROLLEY • OFFICE BUTLER • CHARIOT MULTIFONCTIONS

[ESP] Carro multifuncional realizado en melamina de 19mm y en acero pintado. Apto para servicios de almacenamiento, catering, audiovisuales... Sus paneles laterales aumentan la privacidad deseada. Ruedas de altas prestaciones. Fácil montaje.

[ENG] Multifunctional trolley made of 19 mm melamine and painted steel. Suitable for storage, catering, audiovisual presentations... Its side panels allow increased privacy. High performance wheels. Easy to assemble.

[DE] Mobiler Mehrzweck-Trolley für Büro und Konferenzraum. Stabiles Stahlrohrgestell mit 3 melaminbeschichteten Ablageflächen (19mm). Die Position der Seitenabdeckungen kann frei gewählt werden. Verwendbar u.a. als Aktenwagen, Cateringmöbel, Gerätewagen, Beistellmöbel...

[FR] Chariot multifonctions en mélaminé 19 mm et acier peint. Adapté pour réaliser les tâches de stockage, catering, audiovisuel,... Ses panneaux latéraux offre une plus grande confidentialité. Roues hautes performances. Montage facile.



Medidas / Sizes (cm)

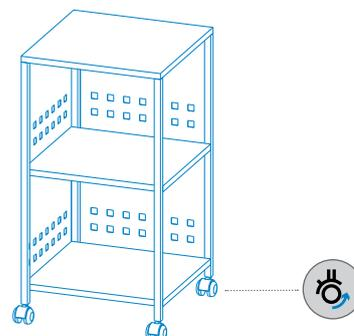
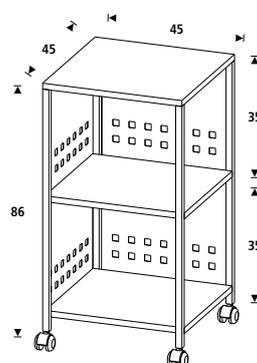

Ref.	cm (embalaje / packaging)	kg / m ³ (embalaje / packaging)
RD-4035	86x47x10	17 kg / 0,037 m ³

CARROS CARPETEROS

FILE TROLLEYS • HÄNGEREGISTERWAGEN • CHARIOT POUR DOSSIERS SUSPENDUS

[ESP] Carro carpetero móvil metálico de 2 niveles. 40 carpetas por nivel. Fácil montaje.

[ENG] Mobile metallic 2-level file trolley. 40 files per level. Easy assembly.

[DE] Einfacher, mobiler 2-stufiger Metallwagen für Hängemappen. Bis zu 40 Mappen pro Stufe.

[FR] Chariot pour dossiers suspendus, mobile, en métal, 2 niveaux. 40 dossiers par niveau. Facile à monter.



Medidas / Sizes (cm)

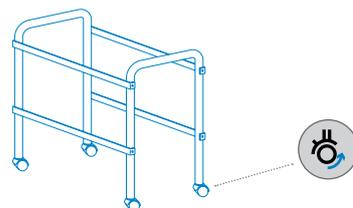
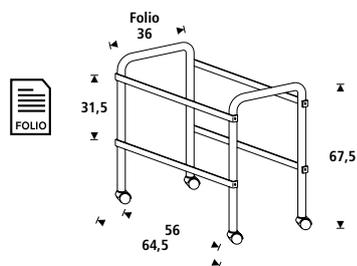

Ref.	cm (embalaje / packaging)	kg / m ³ (embalaje / packaging)
RD-300	68x42x5	3,3 kg / 0,014 m ³

CARROS CARPETEROS

FILE TROLLEYS • HÄNGEREGISTERWAGEN • CHARIOT POUR DOSSIERS SUSPENDUS

[ESP] Carro carpetero móvil metálico regulable. 45 carpetas. Fácil montaje.

[DE] Mobiler, praktischer Metallwagen für ca. 45 Hängemappen.

[ENG] Mobile adjustable metallic file trolley. 45 files. Easy assembly.

[FR] Chariot pour dossiers suspendus, mobile, en métal, réglable. Pour 45 dossiers. Facile à monter.



Medidas / Sizes (cm)

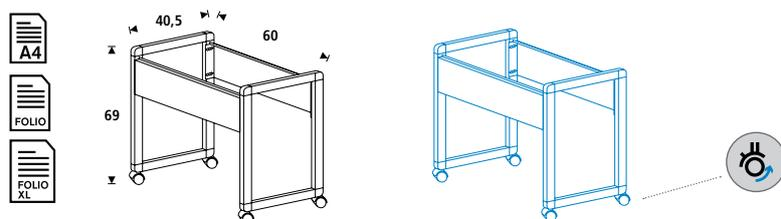

Ref.	cm (embalaje / packaging)	kg / m ³ (embalaje / packaging)
RD-310	68x43x11	8,3 kg / 0,032 m ³

ATRILES LECTERN LUXE

STANDS • STATIVE • SUPPORTS

[ESP] Atril para presentaciones móvil de estructura cromada y curvada superficie de metacrilato de gran diseño. Regulación de las 2 bandejas en altura mediante muelles. Fácil montaje.

[ENG] Stand for mobile presentation, with a chrome structure and a curved, specially designed methacrylate surface. Height adjustment of the 2 shelves through springs. Easy assembly.

[DE] Mobiles Renderpult mit verchromten Gestell. Gebogene Frontplatte aus hochwertigem, halbtransparenten Methacrylat. Höhenverstellung mittels Federmechanik. Untere Glasplatte individuell einstellbar. Leichte Montage.

[FR] Pupitre de conférence mobile, structure chromée et galbée, avec panneau de décoration en méthacrylate. Réglage en hauteur à l'aide de ressorts. Facile à monter.



Cristal templado de 8mm de espesor
Tempered glass of 8mm thickness

Personalización opcional
Optional customization



Preparado para micrófono
Prepared for microphone

Micro no incluido
Microphone not included

Medidas / Sizes (cm)

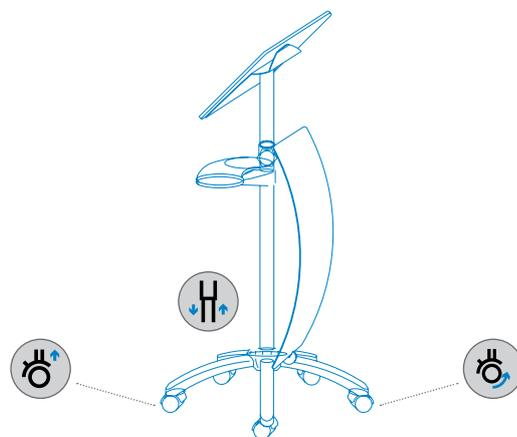
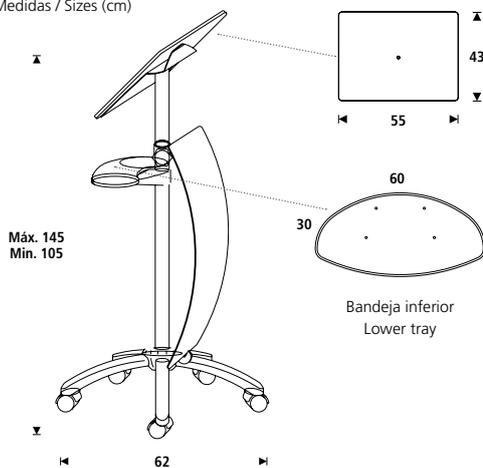

Ref.	cm (embalaje / packaging)	kg / m ³ (embalaje / packaging)
RD-3070	90x62x18	15 kg / 0,097 m ³

ATRILES LECTERN ECO

STANDS • STATIVE • SUPPORTS

[ESP] Atril para presentaciones móvil de estructura metálica. Regulación de altura mediante muelle. Fácil montaje.

[ENG] Stand for mobile presentations with a metallic structure. Height adjustment through springs. Easy assembly.

[DE] Praktisches Rednerstativ mit Metallstruktur. Höhenverstellung mittels Federmechanik. Leichte Montage.

[FR] Pupitre de conférence mobile, structure métal. Réglage en hauteur à l'aide de ressort. Facile à monter.



Ruedas a presión
Click system castors

Medidas / Sizes (cm)

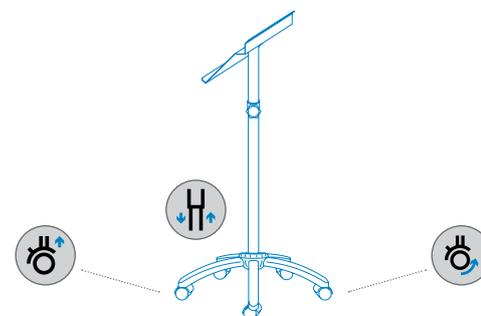
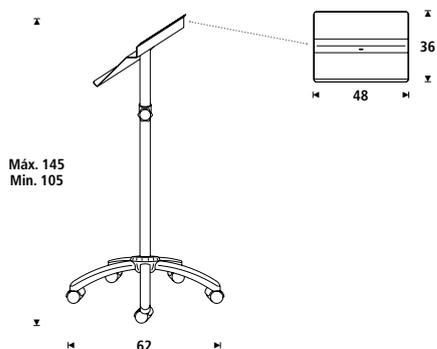

Ref.	cm (embalaje / packaging)	kg / m ³ (embalaje / packaging)
RD-3080	90x62x18	9,5 kg / 0,07 m ³

ACCESORIOS

ACCESSORIES • COMPUTER - UND KLEINMÖBEL • ACCESSOIRES

[ESP] Mesas móviles de melamina. Perfectas para fotocopiadoras y accesorios de gran formato. Incluye puerta metálica y ruedas de diseño. Fácil montaje.

[ENG] Mobile melamine tables. Perfect for photocopiers and big format accessories. Includes a metallic door and specially designed castors. Easy assembly.

[DE] Mobile Druckertische. Auch perfekt geeignet für Fotokopierer, Faxgeräte. Viel Platz für Druckerzubehör. Mit Metalltür und speziellen Doppelaufrollen, belastbar bis 100 Kg. Leichte Montage.

[FR] Meubles mobiles en mélaminé, idéales pour copieur et accessoires de grand format. Porte métallique et roulettes. Facile à monter.



RD-4030

RD-4020



Acabado en haya, bajo pedido
Finished in beech, on request

Medidas / Sizes (cm)

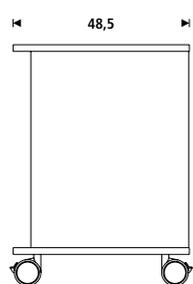

RD-4030

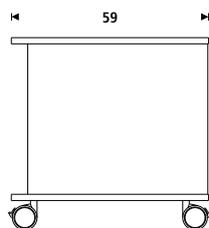
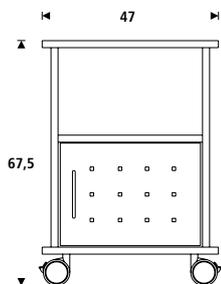

RD-4020

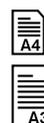
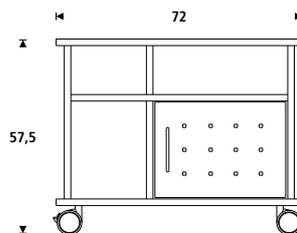

Ref.	cm (embalaje / packaging)	kg / m ³ (embalaje / packaging)
RD-4030	61x54x21	20,95 kg / 0,069 m ³
RD-4020	84x18x62	33 kg / 0,090 m ³

MESA DE TRABAJO ERGONÓMICA MILAGRO ADJUST

ERGONOMIC WORK DESKS • ERGONOMISCHE ARBEITSTISCHE
TABLES DE TRAVAIL ERGONOMIQUES

[ESP] Mesa de trabajo ergonómica móvil con diferentes regulaciones para ayudar de una forma activa en la realización de todo tipo de trabajos consiguiendo la postura deseada en cada momento. Estructura metálica regulable en altura mediante muelles que permite trabajar sentado y de pie o alternar dichas posturas. Regulable en inclinación (80°) mediante sistema de rotación CLICK de fácil activación único en el mercado. El tablero de melamina de 25mm dispone también de una bandeja retráctil para sustentar los objetos de sobremesa si es necesario o esconderla cuando no lo sea. Dispone de cajón inferior para almacenar diferentes objetos personales. El diseño de la estructura permite utilizar la zona inferior lateral para bandeja de 30cm de ancho. Ruedas de alta resistencia con sistema de frenado. Fácil montaje.

[ENG] Mobile ergonomic work desk with different adjustments for any type of work, offering the optimum configuration at any given time. Metal table with height adjustable by springs, to work either sitting or standing or change from one to the other. Tilting table (80°) with an easy action CLICK rotation system, unique in the market. The melamine top also has a retractable tray. Lower drawer to store different personal objects. Tray 30cm wide. Tough wheels with a braking system. Easy to assemble.

[DE] Ein vielseitig verwendbarer Ergänzungstisch für Produktion, Lager, Büro, Konferenzraum und Home Office. Die Höhenverstellung von 74-114 cm ermöglicht sitzende und stehende Tätigkeiten, die Ausschnittform des Fußgestells bietet reichlich Beinfreiheit. Die Tischplatte ist neigbar, unterhalb der Platte befindet sich ein seitlich ausziehbares Utensilienfach. Die stabile Bodenplatte ist 30cm tief und kann als Ablagefläche für einen Drucker oder PC genutzt werden.

[FR] Table de travail ergonomique nomade, avec différents réglages pour rendre plus actif et dynamique tout type de travail et trouver la position souhaitée à tout moment. Table dotée d'une structure métallique, réglable en hauteur grâce aux ressorts qui permettent de travailler assis ou debout, ou bien d'alterner les deux positions. Table avec une inclinaison réglable (80°) par système de rotation CLICK, facile à activer et unique sur le marché. Le dessus en mélamine est équipé d'une tablette rétractable. tiroir inférieur pour ranger les objets personnels. Plateau de 30 cm de large. Roulettes très résistantes et équipées d'un système de freinage. Facile à monter.



RD-3055/1
Acabado en haya
Finished in beech



Cajón lateral derecha e izquierda de 74cm para para accesorios
Lateral right and left drawer to store the accessories

Medidas / Sizes (cm)

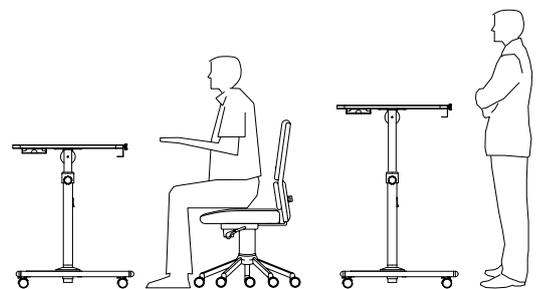
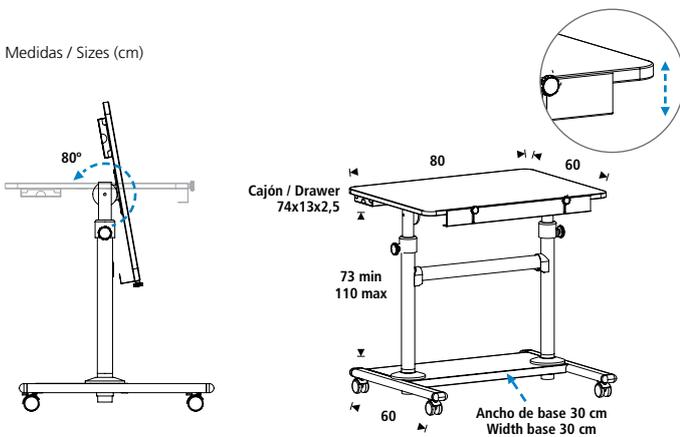

Ref.	cm (embalaje / packaging)	kg / m ³ (embalaje / packaging)	Acabados / Finishes
RD-3055	88x69x17	27 kg / 0.103 m ³	Plata - Silver / Aluminio · Aluminium 
RD-3055/1	88x69x17	27 kg / 0.103 m ³	Plata - Silver / Haya · Beech 

MESAS ORDENADOR MILAGRO

COMPUTER TABLE • COMPUTER - UND KLEINMÖBEL • POSTES INFORMATIQUE

[ESP] Mesa de trabajo móvil regulable en altura mediante muelles. 2 bandejas de melamina regulables en altura que permiten una rotación de 360°. Estructura metálica. Perfecta para trabajar de pie o sentado para adaptarse a las diferentes necesidades actuales de trabajo.

[ENG] Mobile metallic working table with 2 height adjustable melamine shelves. Height adjustment through a spring. Perfect for working either in standing or a sitting position allows to work according today's new working position.

[DE] Universal Stehpult für Arbeiten im Sitzen und Stehen. Stabiles Metallstativ mit feststellbaren Laufrollen. Untere Arbeitsplatte höhenverstellbar. Obere Platte bis 15 Kg, untere bis 5 Kg dauerhaft belastbar.

[FR] Poste de travail mobile avec les 2 plateaux réglables en hauteur. Structure métal. Parfaite pour travailler assis ou debout. Facile à monter.



Medidas / Sizes (cm)

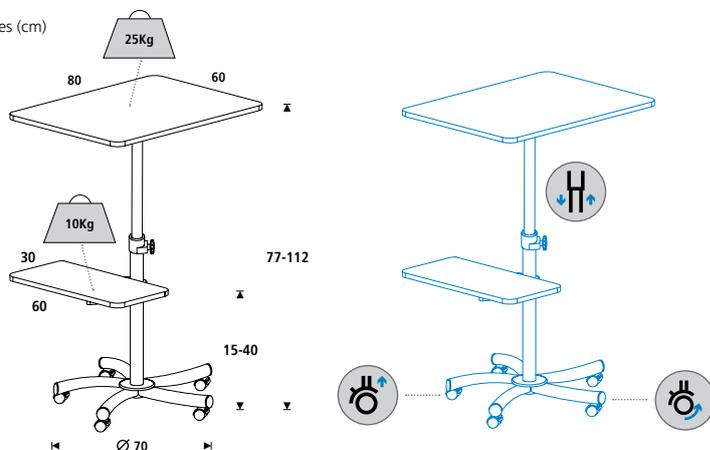

Ref.	cm (embalaje / packaging)	kg / m ³ (embalaje / packaging)
RD-3050	83x69x18	18 kg / 0,100 m ³
RD-3050/1	83x69x18	18 kg / 0,100 m ³

MESAS ORDENADOR

COMPUTER TABLE • COMPUTER TISCHE • POSTES INFORMATIQUE

[ESP] Mesa ordenador móvil de estructura metálica y embellecedores de plástico, así como el reposamuñecas de diseño. Las bandejas son graduables en altura. Fácil montaje. Todas las mesas de ordenador incorporan teclado extraíble.

[ENG] Mobile computer table with metallic structure and plastic trims, as well as the specially designed wrist rest. Height adjustable trays with optional CPU support. Easy assembly. All of the computer tables have a detachable keyboard.

[DE] Mobiler Computertisch für die Unterbringung verschiedener Hardwarekomponenten. Mit Kunststoffapplikationen und Handgelenkstütze. Ablagen und Tastaturlade sind höhenverstellbar und ausziehbar. Leichte Montage.

[FR] Poste informatique mobile, structure métal, belles finitions en plastique avec repose poignet intégré. Plateaux réglables en hauteur. Facile à monter. Toutes les tables pour ordinateur intègrent un clavier coulissant.



Todas las bandejas son desplazables.
All trays are mobile.



Medidas / Sizes (cm)

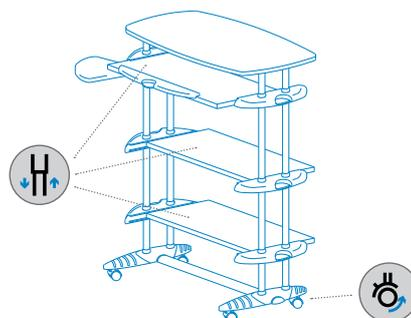
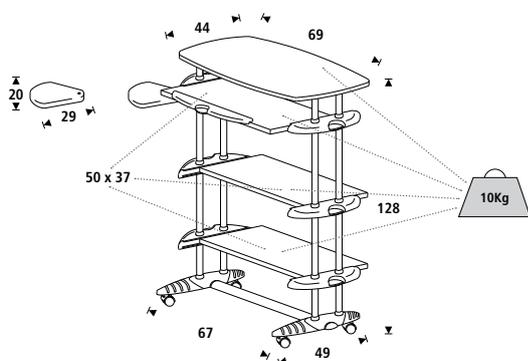

Ref.	cm (embalaje / packaging)	kg / m ³ (embalaje / packaging)
RD-5220	144x53x17	21 kg / 0,120 m ³

MESAS ORDENADOR

COMPUTER TABLE • COMPUTER TISCHE • POSTES INFORMATIQUE

[ESP] Mesa de ordenador móvil con sistema de bloqueo en las ruedas delanteras, de estructura metálica, con bandeja de teclado extraíble mediante guías y topes metálicos. Fácil montaje.

[ENG] Mobile computer table with locking system incorporated in front castors. Metallic structure with metal guided pull-out keyboard tray. Easy assembly.

[DE] Mobiler Computertisch ZETA mit ausziehbarer Tastaturlade und feststellbaren Rollen. Aufgrund der Z-Form des Gestells kann der Tastaturauszug wahlweise nach vorne oder hinten montiert werden.

[FR] Table d'ordinateur sur roulettes dont 2 avec système de blocage. Structure métallique avec tablette coulissante pour le clavier. Facile à monter.



Bandeja extraíble
Pull-out keyboard tray

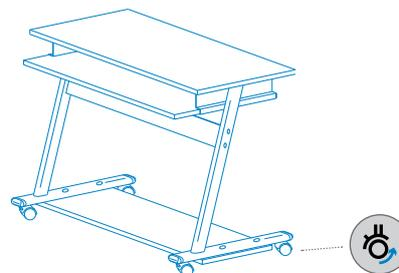
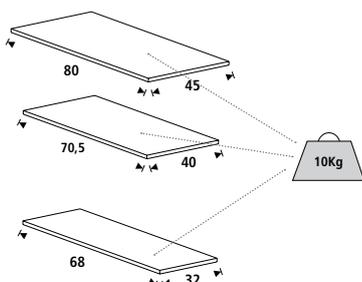
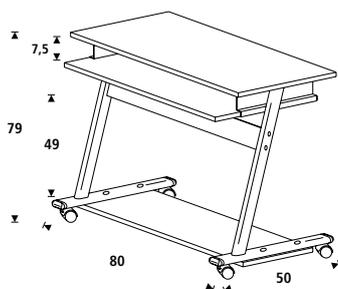

Ref.	cm (embalaje / packaging)	kg / m ³ (embalaje / packaging)
RD-9100	86x55x17	18,35 kg / 0,080 m ³

ACCESORIOS

COMPUTER TABLE • COMPUTER TISCHE • POSTES INFORMATIQUE

[ESP]

Soportes CPU móvil de estructura metálica y regulables.

[ENG] Adjustable mobile CPU supports with metallic structure.

[DE] Mobiler CPU Trolley aus Metall, in der Breite verstellbar.

[FR] Porte unités centrale en métal, mobiles et réglables. Assemblage facile.

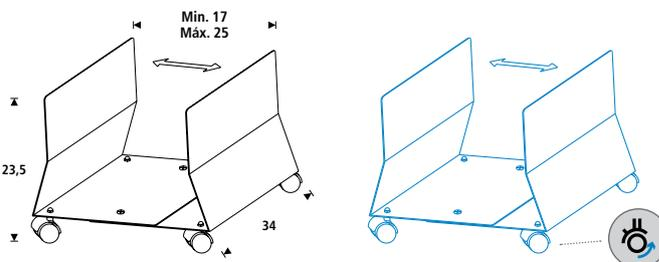

Ref.	cm (embalaje / packaging)	kg / m ³ (embalaje / packaging)
RD-2004	37x22x22	4,5 kg / 0,020 m ³

[ESP] Soporte para teclado y ratón de estructura metálica y reposamuñecas de diseño. Fácil montaje.

[ENG] Key board and mouse support with metallic structure and specially designed wrist rest. Easy assembled.

[DE] Tastaturlade aus Metall. Mit Mausablage und speziell entworfener Handgelenkstütze.

[FR] Support pour clavier et souris, structure métal, avec repose poignet design.



Medidas / Sizes (cm)

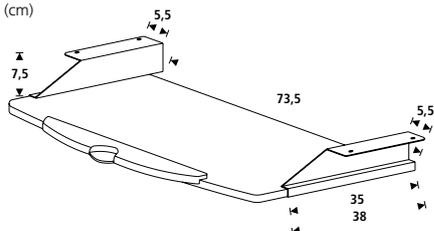

Ref.	cm (embalaje / packaging)	kg / m ³ (embalaje / packaging)
RD-2017	78x46x8	5,6 kg / 0,030 m ³



Características tejido:
30% poliéster
70% PVC
Reacción al fuego según UNE-EN 13773 (Clase 1)

Fabric features:
30% Polyestyrene
70% PVC
Flame retardant UNE-EN 13773 (Class 1)

Para más información, consultar catálogo SET
For further information, consult SET catalogue

CORTINAS ENROLLABLES

ROLLING CURTAINS • ROLLVORHÄNGE • STORES ENROULEURS

[ESP] Gama de cortinas enrollables que permiten personalizar los distintos ambientes de una oficina según las necesidades de trabajo. Cortinas enrollables translúcidas de gran calidad, con núcleo de 43mm de aluminio, mecanismo reversible y cadena con opción de instalación a derecha o izquierda. Tejido realizado en poliéster 30% y PVC 70%. Su amplia gama de medidas, acabados de tejidos y de mecanismos permiten una adaptación total a cualquier espacio.

[ENG] Range of roller blinds that allow to customize the different environments of an office according to the office needs. High quality translucent roller blinds, with 43mm aluminium core with reversible mechanisms, the option to install the chain to the right or left. Fabric made of 30% polyester and 70% PVC. Its wide range of measures, fabrics and finishes of the mechanism allow a total adaptation to any space.

[DE] Produktreihe mit Rollos, die je nach Arbeitsanforderung eine individuelle Gestaltung der verschiedenen Umgebungen eines Büros ermöglichen. Lichtdurchlässige Rollos von hoher Qualität, mit einem 43 mm großen Aluminiumkern mit umkehrbarem Mechanismus sowie Zugkette mit rechts- oder linksseitiger Einbauoption. Gewebe aus 30 % Polyester und 70 % PVC. Das umfangreiche Angebot an verschiedenen Größen, Gewebearten und Ausführungen des Mechanismus ermöglichen die vollständige Anpassung an jeden Raum.

[FR] Gamme de stores enrouleurs permettant de personnaliser différents environnements d'un bureau en fonction des besoins de travail. Store enrouleur tamisant de grande qualité, avec un axe de 43 mm en aluminium équipé de mécanismes réversibles et d'une chaîne en option pouvant être installée à droite ou à gauche. Tissu en polyester 30% et PVC 70%. Vaste gamme de dimensions, tissus et finitions du mécanismes pour une adaptation parfaite à tout type d'espace.

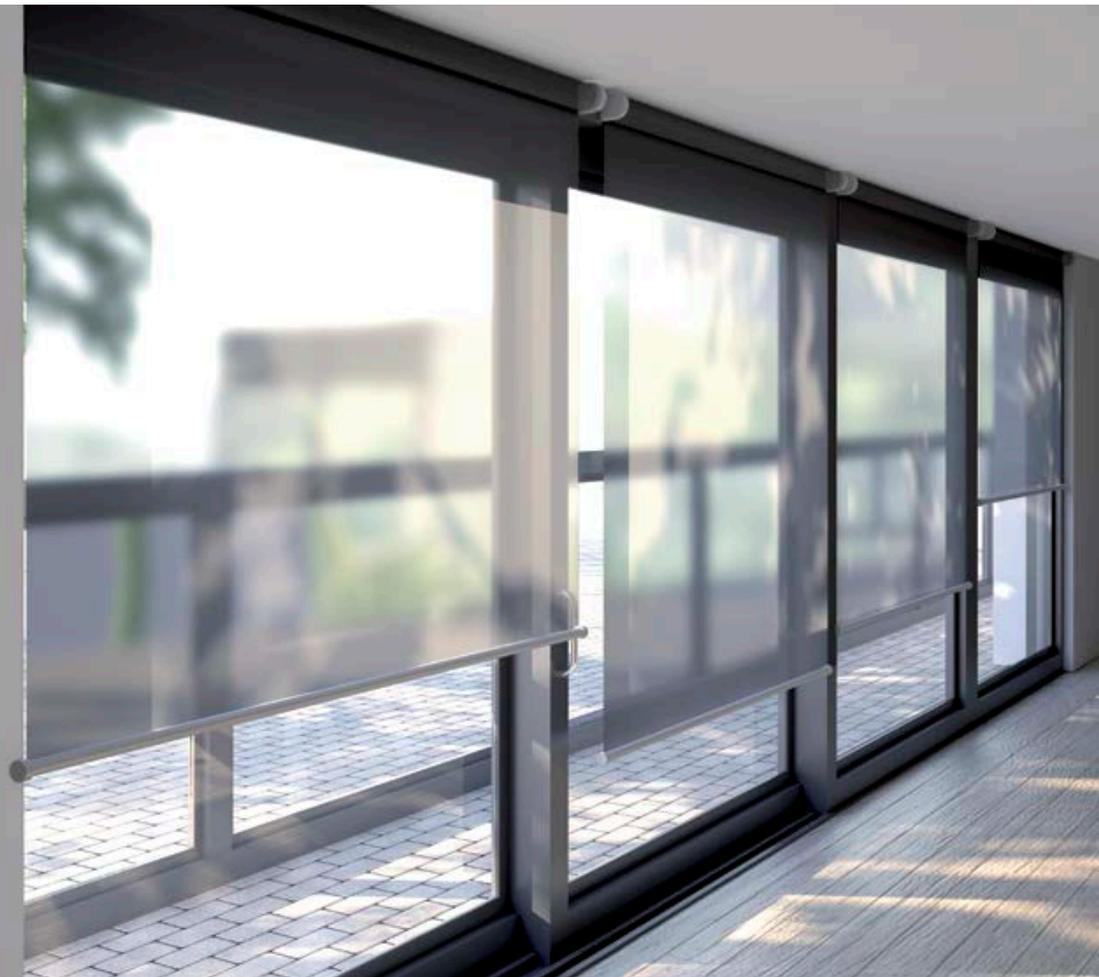

			
<p>Sistema de pernos móviles y colocación rápida del bloc de papel. Permite trabajar con cualquier bloc del mercado.</p>	<p>Pizarras metálicas. Permiten la colocación de imanes y de cualquier tipo de complementos magnéticos.</p>	<p>Superficie apta para la escritura directa con rotuladores de borrado en seco. Fácil y limpio borrado con un simple paño o borrador.</p>	<p>Bandeja porta-útiles de serie, como soporte para rotuladores, borrador, etc.</p>
<p>Includes a system of movable bolts which permit easy and rapid fixing of the paper block Suitable.</p>	<p>Metallic surface. It permits the placement of magnets and any other type of magnetic complements.</p>	<p>White surface suitable for any type of whiteboard marker. Dry wipe cleaning is both easy and clean by using a board rubber or cloth.</p>	<p>Storage tray for marker pens, board rubber, etc.</p>
<p>System mit verstellbaren Aufnahmehalterungen. Ermöglicht das Arbeiten mit allen handelsüblichen Blöcken.</p>	<p>Metalltafel. Ermöglicht das Anbringen von Magneten und magnetischen Accessoires.</p>	<p>Weißer Oberfläche, für die Beschriften mit Whiteboard-Markern geeignet. Einfach und sauber mit einem Tuch oder Wischer sowie gelegentlichen Reinigungsspray zu reinigen.</p>	<p>Ablageschiene für Board- und Flipchartmarker.</p>
<p>Système de boulons mobiles et placement rapide du bloc de papier. Permet de travailler avec n'importe quel bloc du marché.</p>	<p>Tableaux métalliques Permettent de placer des aimants et tout autre objet magnétique.</p>	<p>Surface blanche, sur laquelle on peut écrire avec un feutre effaçable à sec. Nettoyage facile et propre avec un simple chiffon ou un effaceur.</p>	<p>Auget porte-matériel placé en série, sert de support pour feutre, effaceur, etc.</p>
			
<p>Brazos extensibles laterales. Permiten ampliar la superficie de la exposición colgando con imanes hojas adicionales.</p>	<p>Pizarras regulables en altura.</p>	<p>Pizarras con ruedas para poder desplazarlas con total comodidad, fijándolas en el lugar de trabajo gracias a su sistema de bloqueo de las ruedas.</p>	<p>Rueda a presión</p>
<p>Lateral extendable arms which permit the exposition surface to be widened, thus allowing the suspension of adjacent papers with magnets.</p>	<p>Flipchart adjustable in height.</p>	<p>Flipchart with castors which permits easy movement and thanks to its braking system it can be fixed in a working position.</p>	<p>Click system castor</p>
<p>Seitlich einsteckbare Bildhalter ermöglichen die Erweiterung der Präsentationsfläche durch das Anbringen zusätzlicher Blätter mit Magneten.</p>	<p>Höhenverstellbare Tafeln.</p>	<p>Tafeln mit Rollen zum einfachen Standortwechsel, feststellbar durch Rollenblockiersystem.</p>	<p>Rolle mit Klicksystem</p>
<p>Potences laterals, extensibles Permettent d'agrandir la surface d'exposition fixation de feuilles par aimants.</p>	<p>Tableaux réglables en hauteur.</p>	<p>Tableaux à roulettes pour pouvoir être déplacés très facilement et être fixés à l'endroit où on en a besoin grâce au système de blocage des roues.</p>	<p>Cliquez sur système castor</p>



Resistente a exteriores



Velcro



Chinchetas



Corcho auto-reparable



Superficie para rotuladores de borrado en seco.

Waterproof

Velcro friendly

Pinnable

Self healing cork

surface for writing with dry-wipe markers

Wasserfest

Klett-tauglich

Pinnbar

Selbstheilender kork

Beschreiben mit trocken abwischbaren Markern.

Étanche

Velcro respectueux de l'environnement

Punaisable

Liège autorégénérant

surface pour écriture au marqueur effaçable à sec

ÍNDICE • INDEX



SkinCERAMIC
pag 10 · RD-6620CER /
RD-6621CER



SkinPRO
pag 12 · RD-6520PRO /
RD-6521PRO



SkinCOLOUR
pag 14 · RD-6419R / RD-6420R
/ RD-6421R



SkinSHAPE
pag 16 · RD-6460
RD-6450 / RD-6440



SkinAGILE
pag 18 · RD-6421AG



SkinCUBE
pag 20 · RD-687654



SkinMATT
pag 22 · RD-6420MATT



SkinMUSIC
pag 24 · RD-6420RM



SkinLIQUID
pag 26 · RD-6820V19



SkinPINBOARD
pag 28 · RD-6248



SkinPLANNER
pag 30 · RD-6420UP

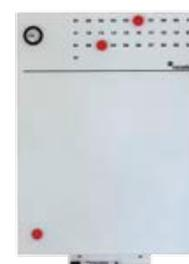

SkinCLOCK
pag 32 · RD-6419CL



SkinSUPPORT
pag 34 · RD-6875



SkinPROTECT
pag 36 · RD-6419PRT



SkinBLOCK
pag 38 · RD-6430R



SkinnyNOTES
pag 40 · RD-4323MX

ÍNDICE • INDEX



SkinMAP
pag 42 · RD-6421MAPWD

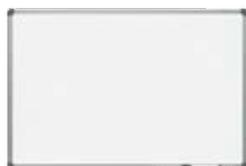

pag 45 · RD-6500
RD-6400 / RD-6300

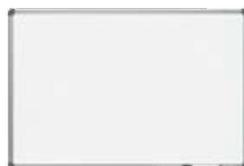

pag 46 · RD-6505MAT

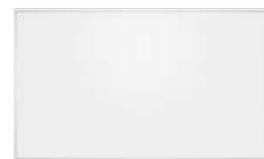

pag 47 · RD-6950
Doble cara / Double side



pag 48 · RD-6701
Cristal / Glass



pag 49 · RD-6500GRCH
Tiza / Chalk



pag 50 · RD-6200
Corcho / Cork



pag 51 · RD-6600
Tapizada / Felt



pag 52 · RD-6728



pag 54 · RD-6870 PLUS



pag 56 · RD-6870



pag 58 · RD-8090



pag 59 · RD-6877

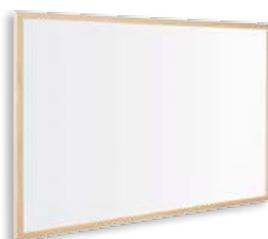

pag 60 · RD-6106V19

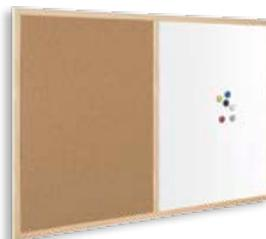

pag 61 · RD-6120V19



pag 62 · RD-6100V19

ÍNDICE • INDEX



NEW

pag 63 · RD-S4319



NEW

pag 63 · RD-S4300V19



NEW

pag 64 · RD-S4320



NEW

pag 64 · RD-S4321



pag 64 · RD-530WH /
RD-530GR



NEW

pag 65 · I4319



NEW

pag 65 · Smiley15



NEW

pag 65 · RD-S4040MX*12



NEW

pag 66 · RD-S5050MX



pag 66 · RD-S0301A4



pag 67 · RD-S4200



pag 67 · RD-630



pag 67 · 2981CY



pag 68 · RD-618V15
TRANSFORMER



pag 70 · RD-660



pag 72 · RD-617V15 TOUCH

ÍNDICE • INDEX



pag 74 · RD-616 ECONOMY



pag 76 · RD-610V19 CLASSIC



pag 78 · RD-600 BASIC



pag 80 · RD-3641V17
INTERIOR / INDOOR



pag 81 · RD-3651V19
INTERIOR / INDOOR



pag 82 · RD-3661V19
INTERIOR / INDOOR



pag 83 · RD-3676V17
INTERIOR / INDOOR



pag 84 · RD-3686V17
INTERIOR / INDOOR



pag 85 · RD-3696V17
INTERIOR / INDOOR



pag 86 · RD-3671V17EX
INDOOR / OUTDOOR



pag 87 · RD-3681V17EX
INDOOR / OUTDOOR



pag 88 · RD-3691V17EX
INDOOR / OUTDOOR



pag 89 · 3630-LC4



pag 90 · RD-3045



pag 91 · RD-3046



pag 91 · RD-3047

ÍNDICE • INDEX



pag 92 · RD-8304



pag 93 · RD-2980



pag 94 · RD-8100



pag 96 · RD-8210



pag 97 · BS0705S



pag 98 · BSA2CH



pag 99 · BS0720



pag 100 · BS0701



pag 101 · BS0770S



pag 102 · RD-3800



pag 103 · RD-3806



pag 104 · RD-2025



pag 105 · RD-2026



pag 106 · RD-4036
HOT DESK



pag 108 · RD-4035



pag 109 · RD-300

ÍNDICE • INDEX



pag 110 · RD-310



pag 111 · RD-3070
LECTERN LUXE



pag 112 · RD-3080
LECTERN ECO



pag 113 · RD-4030



pag 114 · RD-3055
MILAGRO ADJUST



pag 116 · RD-3050
MILAGRO



pag 117 · RD-5220



pag 118 · RD-9100



pag 119 · RD-2004



pag 119 · RD-2017

PEDIDOS

NOVEDAD WEB!

Los pedidos cursados vía web tendrán un 2% de descuento hasta fin de promoción.
Si los pedidos no se tramitan a través de la web deben de efectuarse siempre por escrito.

LISTA DE PRECIOS

Precios sin IVA.
Válidos a partir del 1 de febrero de 2019.

PAGOS

El incumplimiento del vencimiento del pago puede provocar la retención de nuevos pedidos hasta la cancelación del impago y la tramitación legal automática a través de nuestras empresas de cobro.
Anticipado 2%

GARANTÍA

2-5 años para todos los productos Rocada en condiciones de uso normales.
Rocada se compromete a entregar un producto de calidad conforme con las especificaciones requeridas.

PLAZOS DE ENTREGA

Máximo 7 días laborables para pedidos diarios.

TRANSPORTE

Portes para Península:
Pedido neto hasta 50 €: cargo de 10 € en concepto de portes.
A partir de 50 € hasta 150 €: 5 € en concepto de portes.
A partir de 150 €: portes pagados.
Portes para Canarias, Ceuta y Melilla: 800 €. El servicio de entrega de la mercancía solo se realizará hasta la puerta de la calle. Si es necesario entregar el material dentro de su destinación, la entrega tendrá un coste extra de +8% sobre PVP.

INCIDENCIAS Y DEVOLUCIONES

Avisar dentro de las 24 horas de la recepción de la mercancía para incidencias con el transporte. No se aceptarán incidencias pasadas las 24h desde la recepción. Y nunca se aceptaran devoluciones, sin previa confirmación desde Rocada.

JURISDICCIÓN

Para cuestión que pueda derivarse de la interpretación o aplicación de estas normas el cliente y Rocada se someten expresamente a la jurisdicción y fuero de los Juzgados y Tribunales de la ciudad de Barcelona, con renuncia a cualquier otro si lo hubiere.

ORDERS

All orders shall be received in writing.

PAYMENTS

All payments should be received on or before the due date indicated on the invoice. All customers shall be covered by CESCE insurance company. Rocada is forced to communicate any delay or nonpayment. Rocada is keen to offer an extra discount of -2% for in advance payments (before loading).

GUARANTEE

All Rocada products have between 2 and 5 years guarantee.

DELIVERY LEADTIME

Between 10-15 working days for stock orders. We shall inform the approximate delivery time once the order has been placed. Each delivery shall be deemed a separate transaction and the failure of any one delivery shall not affect the due performance of the order. Any request to vary the quantity or delivery date of an order must be notified in writing. Ex-works prices.

CLAIMS - RETURN

All claims for damage to goods or partial loss of goods in transit must be submitted to, and received by us within 2 days of delivery. No goods can be returned without prior notification and an official pick up note produced by us.

JURISDICTION

Spanish law only shall apply to this contract and all disputes shall be dealt with by the Spanish courts alone.

MODIFICACIONES / MODIFICATIONS

[ESP] Esta tarifa anula las anteriores. Nos reservamos el derecho de modificar sin previo aviso características, formas y medidas de nuestros productos. Tarifa válida excepto error tipográfico.

[ENG] This pricelist annuls all the previous ones. We reserve the right to change product specifications, sizes or colors without prior notice. Errors, omissions excluded.



Rocada Spain
rocada@rocada.com
www.rocada.com

Rocada Deutschland GmbH
info@rocada.de
www.rocada.de

Distribuido por / Distributed by: